

~~EXPIRED~~

ALLOWED _____ FINAL FEE PAID _____

PATENT NO. _____ DATE _____

 **Kruysman**

32-00 Stillman Avenue Long Island City, NY 11101 (718) 433-3800 (800) 221-3218

No. 8029-3L ©Kruysman

ZOOM AND PAN IMAGING DESIGN TOOL - PROVISIONAL

Iviewit.com, Inc.
005707.P021Z-

0170311



Title: Zoom and Pan Imaging Design Tool
Inventor(s): Utley
Appl. No.: 60/233,341

Dkt. No. 57103/123
BLG

- PTO/SB/83 Request For Withdrawal As Attorney Or Agent/in triplicate (2 pgs.)
- Declaration Of Barry L. Grossman In Support Of Notice Of Withdrawal, and Tabs 1-3/in triplicate (8 pgs.)

Commissioner for Patents:

Please acknowledge receipt of the above-identified documents by applying the U.S. Patent and Trademark Office receipt stamp hereto and mailing this card.

Respectfully,
Foley & Lardner

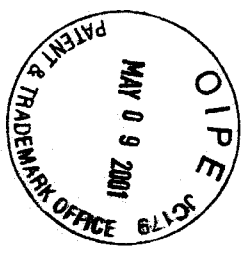

5/14/01
GM

Please type a plus sign (+) inside this box →

Under the Paperwork Reduction Act of 1995, no persons are required to respond to a collection of information unless it displays a valid OMB control number.

Approved for use through 8/30/99. CMB 0651-0035
Patent and Trademark Office: U.S. DEPARTMENT OF COMMERCE
Page 1 of 2

REQUEST FOR WITHDRAWAL AS ATTORNEY OR AGENT	Application Number	60/233,341
	Filing Date	09/18/2000
	First Named Inventor	Utley
	Group Art Unit	Unknown
	Examiner Name	Unknown
	Attorney Docket Number	57103/123

To: Assistant Commissioner for Patents
Washington, DC 20231

See attached explanation.

- The correspondence address is NOT affected by this withdrawal.
- Change the correspondence address and direct all future correspondence to:

<input type="checkbox"/> Customer Number	CORRESPONDENCE ADDRESS	Place Customer Number Bar Code Label here	
OR	<input type="checkbox"/>		
<input checked="" type="checkbox"/> Firm or Individual Name	Brian G. Utley, President		
Address	Iviewit.com, Inc.		
Address	One Boca Place, 2255 Glades Road, Suite 337 West		
City	Boca Raton	State Florida	ZIP 33431
Country	U.S.A.		
Telephone	561 999 8899	Fax	561 999 8810

This request is enclosed in triplicate.

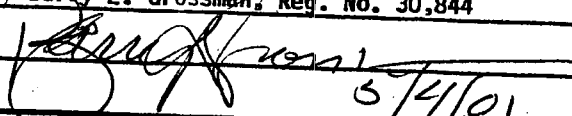
Name	Barry L. Grossman, Reg. No. 30,844
Signature	
Date	5/4/01

**NOTE: Withdrawal is effective when approved rather than when received.
Unless there are at least 30 days between approval of withdrawal and the expiration date of a time period for response or possible extension period, the request to withdraw is normally disapproved.**

Burden Hour Statement: This form is estimated to take 0.2 hours to complete. Time will vary depending upon the needs of the individual case. Any comments on the amount of time you are required to complete this form should be sent to the Chief Information Officer, Patent and Trademark Office, Washington, DC 20231. DO NOT SEND FEES OR COMPLETED FORMS TO THIS ADDRESS. SEND TO: Assistant Commissioner for Patents, Washington, DC 20231.

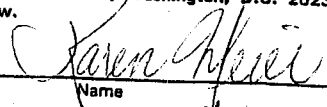
CERTIFICATE OF MAILING	
I hereby certify that this correspondence is being deposited with the United States Postal Service with sufficient postage as First Class Mail in an envelope addressed to: Commissioner for Patents, Washington, D.C. 20231, on the date below.	
5/4/01	
Date	Name
	Karen Meier

On behalf of myself and the following attorneys of record who are, or were, with the firm of Foley & Lardner, we hereby apply to withdraw as attorney or agent for the above-identified application.

RUSSELL J. BARRON	Reg. No. 29,512
DAVID J. BATES	Reg. No. 39,902
STEVEN C. BECKER	Reg. No. 42,308
DOUGLAS A. BOEHM	Reg. No. 32,014
EDWARD W. BROWN	Reg. No. 22,022
CHARLES G. CARTER	Reg. No. 35,093
ALISTAIR K. CHAN	Reg. No. 44,603
JOHN C. COOPER III	Reg. No. 26,416
JEFFREY N. COSTAKOS	Reg. No. 34,144
WILLIAM J. DICK	Reg. No. 22,205
BARRY L. GROSSMAN	Reg. No. 30,844
PAUL S. HUNTER	Reg. No. 44,787
KATHERINE D. LEE	Reg. No. 44,865
KEITH D. LINDENBAUM	Reg. No. 40,365
DAVID G. LUETTGEN	Reg. No. 39,282
RICHARD J. MC KENNA	Reg. No. 35,610
JAMES G. MORROW	Reg. No. 32,505
TODD A. RATHE	Reg. No. 38,276
MICHAEL D. RECHTIN	Reg. No. 30,128
CHRISTOPHER M. TUROSKI	Reg. No. 44,456
JAMES A. WILKE	Reg. No. 34,279
JOSEPH N. ZIEBERT	Reg. No. 35,421
WALTER E. ZIMMERMAN	Reg. No. 40,883

The reasons for this request are: the client has a large and long-standing unpaid bill, and has advised the undersigned that it is unable to pay for past work or for current additional work, as explained in the attached supporting declaration.

IN THE UNITED STATES PATENT AND TRADEMARK OFFICE

Applicant: Utley
Title: Zoom and Pan Imaging Design Tool
Appl. No.: 60/233,341
Filing Date: 09/18/2000
Examiner: Unknown
Art Unit: Unknown

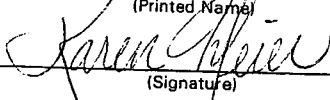
CERTIFICATE OF MAILING	
I hereby certify that this correspondence is being deposited with the United States Postal Service with sufficient postage as First Class Mail in an envelope addressed to: Commissioner for Patents, Washington, D.C. 20231, on the date below.	
Karen Meier	_____ (Printed Name)
	_____ (Signature)
May 4, 2001	_____ (Date of Deposit)

DECLARATION OF BARRY L. GROSSMAN
In Support Of And As A Part Of
Notice Of Withdrawal Under 37 CFR 1.36

I, Barry L. Grossman, declare as follows.

1. I am an attorney with the law firm of Foley & Lardner. I am a partner in the Milwaukee office of the firm. I am one of the attorneys of record in the referenced application. Several other attorneys at Foley & Lardner also are named as attorneys of record in the referenced patent application. The attorneys are all individually identified by name and registration number on the accompanying Form PTO/SB/83.
2. I am a member of the Bars of Virginia, the District of Columbia, and Wisconsin.
3. I am registered to practice before the Patent and Trademark Office. My registration number is 30,844.
4. This Declaration is submitted in support of and as part of the accompanying Notice of Withdrawal under 37 CFR 1.36.
5. The Notice of Withdrawal is submitted on behalf of all Foley & Lardner attorneys who would be named in the Power of Attorney to be submitted in the referenced application. In accordance with MPEP 402.06, I am signing the Notice of Withdrawal on behalf of each Foley & Lardner attorney who would be named as an attorney of record. Mr. Douglas A. Boehm, Registration No. 32,014, would also be named as an attorney of record. Mr. Boehm is no longer associated with Foley &

Lardner. However, I have been authorized to act on his behalf (Tab 1).

Accordingly, this request includes a request to withdraw on behalf of Mr. Boehm.

6. The attorneys at Foley & Lardner are seeking to withdraw as counsel in this application because the client responsible for the application, Iviewit.com, Inc. has a large and long-standing unpaid bill for legal services related to this application and other pending applications which it refuses to pay. Iviewit owes Foley & Lardner \$142,531.08. This amount includes \$117,396.16 for legal services, and \$25,134.92 for disbursements that we have paid on their behalf. These fees and disbursements relate to services we have provided on multiple different United States and PCT patent applications. We are seeking to withdraw in all pending applications.
7. On or about March 5, 2001, I was advised in a telephone discussion with Mr. Raymond Hersh, Chief Financial Officer of Iviewit, that Iviewit would not pay its past due bill and would not make any future payments to Foley & Lardner for legal services unless and until it was successful in obtaining additional financing.
8. On March 19, 2001, we advised Iviewit that not being paid for our past work, and not being paid for future work, was not an acceptable arrangement for Foley & Lardner. We offered to discuss a reasonable payment plan with Iviewit. A copy of our letter of March 19 is attached at Tab 2. We have received no response to this letter.
9. On April 3, 2001, having received no response to the March 19 letter, we again wrote to Iviewit to advise them that we were initiating steps to withdraw as their counsel in all pending matters. A copy of the April 3 letter is attached at Tab 3. We have had no response or reaction by Iviewit to our April 3, 2001 letter.
10. We have continued to advise Iviewit of all communications received from the Patent and Trademark Office, so they are aware of all actions in all their pending applications.
11. The status of the referenced application is as follows: As of the date of mailing the Notice To File Missing Parts Of Provisional Application mailed December 4, 2000, remains outstanding with the United States Patent and Trademark Office.

I FURTHER DECLARE THAT all statements made herein of my own knowledge are true, and that all statements made on information and belief are believed to

be true; and further that these statements were made with the knowledge that willful false statements and the like so made are punishable by fine or imprisonment, or both, under Section 1001 of Title 18 of the United States Code, and that such willful false statements may jeopardize the validity of the application or any patent issuing thereon.

Respectfully submitted,

Date

5/4/01

By

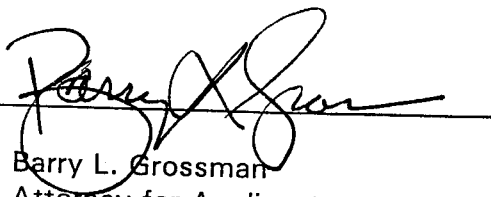

Barry L. Grossman
Attorney for Applicant
Registration No. 30,844

FOLEY & LARDNER
Firststar Center
777 East Wisconsin Avenue
Milwaukee, Wisconsin 53202-5367
Telephone: (414) 297-5724
Facsimile: (414) 297-4900

FOLEY & LARDNER

ATTORNEYS AT LAW

FIRSTAR CENTER
777 EAST WISCONSIN AVENUE
MILWAUKEE, WISCONSIN 53202-5367
TELEPHONE (414) 271-2400
FACSIMILE (414) 297-4900

WRITER'S DIRECT LINE
414-297-5724

BRUSSELS
CHICAGO
DENVER
DETROIT
JACKSONVILLE
LOS ANGELES
MADISON
MILWAUKEE

ORLANDO
SACRAMENTO
SAN DIEGO
SAN FRANCISCO
TALLAHASSEE
TAMPA
WASHINGTON, D.C.
WEST PALM BEACH

EMAIL ADDRESS

bgrossman@foleylaw.com@foley
law.com

CLIENT/MATTER NUMBER
999100/0301

April 19, 2001

Doug Boehm, Esq.
7518 N. Crossway Road
Fox Point, WI. 53217

Re: Withdrawal as Counsel for Iviewit

Dear Doug:

I am writing to inquire if you want to remain as counsel of record in the pending Iviewit.com patent applications.

Foley is initiating procedures to withdraw as counsel in all the Iviewit pending applications. The Power of Attorney form names individual attorneys, not a law firm, as the attorneys of record. Each attorney of record must withdraw. You are one of the attorneys named as attorney of record, along with other Foley attorneys. We can withdraw as counsel for all the Foley attorneys. However, since you are no longer a Foley attorney, we cannot withdraw on your behalf unless you authorize us to do so. Accordingly, I am asking whether you authorize us to act on your behalf and state to the PTO that you also wish to withdraw as attorney of record. If we do not include you in our withdrawal papers, you will remain as attorney of record. You can then either continue to prosecute the applications on behalf of Iviewit or submit your own withdrawal, as you choose.

If you want us to withdraw on your behalf, please so indicate by signing below and return the original signed letter to us. We plan on submitting our materials no later than April 25. If we do not hear from you by then, we will submit our papers without including you.

Doug Boehm

April 19, 2001

Page 2

If you have any questions about this matter, please do not hesitate to contact me.
I hope all is well. Best regards.

Sincerely,

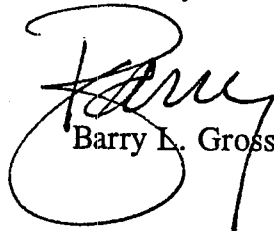

Barry L. Grossman

I authorize Foley & Lardner to act on
my behalf and withdraw me as an attorney
of record in all pending patent applications
in which I am named as an attorney of record
and which are assigned to Iviewit.com.



Doug Boehm, Reg. No. 32,014

Date: 4/21/01

FOLEY & LARDNER

ATTORNEYS AT LAW

BRUSSELS
CHICAGO
DENVER
DETROIT
JACKSONVILLE
LOS ANGELES
MADISON
MILWAUKEE

FIRSTAR CENTER
777 EAST WISCONSIN AVENUE
MILWAUKEE, WISCONSIN 53202-5367
TELEPHONE (414) 271-2400
FACSIMILE (414) 297-4900

ORLANDO
SACRAMENTO
SAN DIEGO
SAN FRANCISCO
TALLAHASSEE
TAMPA
WASHINGTON, D.C.
WEST PALM BEACH

WRITER'S DIRECT LINE
(414) 297-5724

EMAIL ADDRESS

bgrossman@foleylaw.com

CLIENT/MATTER NUMBER

057103/0101

March 19, 2001

Mr. Brian G. Utley
President & COO
Iviewit.com, Inc.
One Boca Place
2255 Glades Road, Suite 337 West
Boca Raton, Florida 33431

BY FACSIMILE

Re: Status of Pending Matters and Account

Dear Mr. Utley:

We need to resolve our continued representation of Iviewit in light of the overdue status of your account.

Iviewit owes Foley & Lardner approximately \$140,000. This amount has been outstanding for a significant period of time. I understand that Iviewit has adopted a policy of not paying service providers until it is able to obtain additional financing from investors. This arrangement is not acceptable to Foley & Lardner. We are not willing to remain as counsel to Iviewit or retain responsibility for your pending matters without getting paid for our past or future services. Accordingly, unless we reach a mutually acceptable accommodation about payment, we will timely and properly withdraw as your counsel in all matters in which we are representing Iviewit.

We will be willing to remain as counsel to Iviewit under the following conditions: (1) Iviewit begins immediately to make monthly payments of a minimum of \$20,000 per month, and agrees to pay interest at the prime rate for the unpaid balance, until the past due amount is fully paid; and (2) Iviewit pays in advance, both for professional services and for disbursements on your behalf, for any future work we are asked to perform.

FOLEY & LARDNER

Mr. Brian G. Utley

Iviewit.com, Inc.

March 19, 2001

Page 2

If the foregoing is acceptable to Iviewit, please so indicate by signing below and returning a signed copy of this letter to us, along with your first monthly payment of \$20,000. If we do not hear from you by March 31, we will begin to take all necessary steps to withdraw as your counsel. In withdrawing as counsel, we will not waive any of our rights to recover the money due to us. If you choose not to make a payment by March 31, please provide us with mailing instructions for return of your file materials to you or to substitute counsel.

I regret that we must take this action. However, your stated policy of not paying service providers, like Foley & Lardner, leaves us no choice. We cannot continue to represent Iviewit without payment for our past or future services. If you have any questions about this matter, please do not hesitate to contact me.

Sincerely,



Barry L. Grossman

By signing below and sending the enclosed check for \$20,000 to be applied against its past due account, Iviewit.com agrees to the terms stated in this letter.

By: _____

Brian G. Utley

President, Iviewit.com

cc: Raymond Hersh

FOLEY & LARDNER

ATTORNEYS AT LAW

BRUSSELS
CHICAGO
DENVER
DETROIT
JACKSONVILLE
LOS ANGELES
MADISON
MILWAUKEE

FIRSTAR CENTER
777 EAST WISCONSIN AVENUE
MILWAUKEE, WISCONSIN 53202-5367
TELEPHONE (414) 271-2400
FACSIMILE (414) 297-4900

ORLANDO
SACRAMENTO
SAN DIEGO
SAN FRANCISCO
TALLAHASSEE
TAMPA
WASHINGTON, D.C.
WEST PALM BEACH

WRITER'S DIRECT LINE
(414) 297-5724

EMAIL ADDRESS
bgrossman@foleylaw.com

CLIENT/MATTER NUMBER
057103/0101

April 3, 2001

Mr. Brian G. Utley
President & COO
Iviewit.com, Inc.
One Boca Place
2255 Glades Road, Suite 337 West
Boca Raton, Florida 33431

Re: Pending Matters; Withdrawal As Counsel

Dear Mr. Utley:

We have not received any response to our letter of March 19. Accordingly, as stated in that letter, we are initiating steps to advise the U.S. Patent and Trademark Office and all applicable foreign patent offices or international organizations that we are no longer serving as counsel to Iviewit. We will instruct all of these organizations to send future correspondence directly to your attention. If you would prefer to have future correspondence sent to a different address, please provide us with the pertinent mailing information as soon as possible.

Enclosed are copies of Written Opinions received in your PCT International Application No. PCT/US00/15405 and PCT International Application No. PCT/US00/15406.

Sincerely,

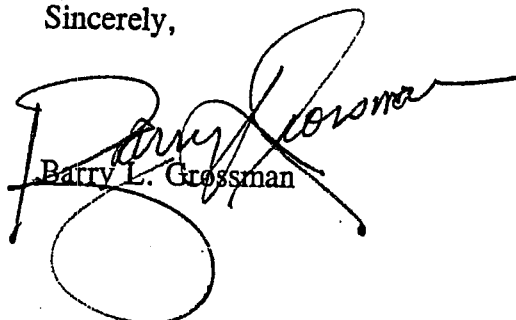
Barry L. Grossman

Enclosures
cc: Raymond Hersh (w/enclosures)



UNITED STATES PATENT AND TRADEMARK OFFICE

COMMISSIONER FOR PATENTS
UNITED STATES PATENT AND TRADEMARK OFFICE
WASHINGTON, D.C. 20231
www.uspto.gov

APPLICATION NUMBER	FILING/RECEIPT DATE	FIRST NAMED APPLICANT	ATTORNEY DOCKET NUMBER
60/233,341	09/18/2000	Brian G. Utley	57103/123

Foley & Lardner
777 East Wisconsin Avenue
Firststar Center
Milwaukee, WI 53202-5367

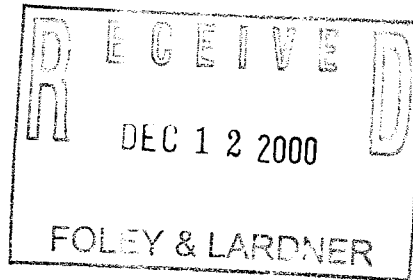

FORMALITIES LETTER



Date Mailed: 12/04/2000

NOTICE TO FILE MISSING PARTS OF PROVISIONAL APPLICATION

FILED UNDER 37 CFR 1.53(c)

Filing Date Granted

MP
RESPONSE DUE 04FE2001
DECL FEE

An application number and filing date have been accorded to this provisional application. The items indicated below, however, are missing. Applicant is given TWO MONTHS from the date of this Notice within which to file all required items and pay any fees required below to avoid abandonment. Extensions of time may be obtained by filing a petition accompanied by the extension fee under the provisions of 37 CFR 1.136(a).

- The statutory basic filing fee is missing.
Applicant must submit \$ 150 to complete the basic filing fee and/or file a small entity statement claiming such status (37 CFR 1.27).
- To avoid abandonment, a late filing fee or oath or declaration surcharge as set forth in 37 CFR 1.16(e) of \$50 for a non-small entity, must be submitted with the missing items identified in this letter.
- The balance due by applicant is \$ 200.

A copy of this notice MUST be returned with the reply.

James Washington
Customer Service Center
Initial Patent Examination Division (703) 308-1202

PART 1 - ATTORNEY/APPLICANT COPY

UNITED STATES PATENT AND TRADEMARK OFFICE

 COMMISSIONER FOR PATENTS
 UNITED STATES PATENT AND TRADEMARK OFFICE
 WASHINGTON, D.C. 20231
 www.uspto.gov

APPLICATION NUMBER	FILING/RECEIPT DATE	FIRST NAMED APPLICANT	ATTORNEY DOCKET NUMBER
60/233,341	09/18/2000	Brian G. Utley	57103/123

Foley & Lardner
 777 East Wisconsin Avenue
 Firststar Center
 Milwaukee, WI 53202-5367

FORMALITIES LETTER

Date Mailed: 12/04/2000

NOTICE TO FILE MISSING PARTS OF PROVISIONAL APPLICATION
FILED UNDER 37 CFR 1.53(c)
Filing Date Granted

An application number and filing date have been accorded to this provisional application. The items indicated below, however, are missing. Applicant is given TWO MONTHS from the date of this Notice within which to file all required items and pay any fees required below to avoid abandonment. Extensions of time may be obtained by filing a petition accompanied by the extension fee under the provisions of 37 CFR 1.136(a).

- The statutory basic filing fee is missing.
Applicant must submit \$ 150 to complete the basic filing fee and/or file a small entity statement claiming such status (37 CFR 1.27).
- To avoid abandonment, a late filing fee or oath or declaration surcharge as set forth in 37 CFR 1.16(e) of \$50 for a non-small entity, must be submitted with the missing items identified in this letter.
- The balance due by applicant is \$ 200.

*A copy of this notice **MUST** be returned with the reply.*

James Washington

 Customer Service Center
 Initial Patent Examination Division (703) 308-1202

PART 2 - COPY TO BE RETURNED WITH RESPONSE



UNITED STATES PATENT AND TRADEMARK OFFICE

COMMISSIONER FOR PATENTS
 UNITED STATES PATENT AND TRADEMARK OFFICE
 WASHINGTON, D.C. 20231
 www.uspto.gov

APPLICATION NUMBER	FILING DATE	GRP ART UNIT	FIL FEE REC'D	ATTY. DOCKET NO	DRAWINGS	TOT CLAIMS	IND CLAIMS
60/233,341	09/18/2000		0	57103/123	7		

Foley & Lardner
 777 East Wisconsin Avenue
 Firststar Center
 Milwaukee, WI 53202-5367

FILING RECEIPT



OC000000005592299

Date Mailed: 12/04/2000

Receipt is acknowledged of this provisional Patent Application. It will be considered in its order and you will be notified as to the results of the examination. Be sure to provide the U.S. APPLICATION NUMBER, FILING DATE, NAME OF APPLICANT, and TITLE OF INVENTION when inquiring about this application. Fees transmitted by check or draft are subject to collection. Please verify the accuracy of the data presented on this receipt. **If an error is noted on this Filing Receipt, please write to the Office of Initial Patent Examination's Customer Service Center. Please provide a copy of this Filing Receipt with the changes noted thereon. If you received a "Notice to File Missing Parts" for this application, please submit any corrections to this Filing Receipt with your reply to the Notice. When the PTO processes the reply to the Notice, the PTO will generate another Filing Receipt incorporating the requested corrections (if appropriate).**

Applicant(s)

Brian G. Utley, Boca Raton, FL ;

Continuing Data as Claimed by Applicant

Foreign Applications

If Required, Foreign Filing License Granted 12/01/2000

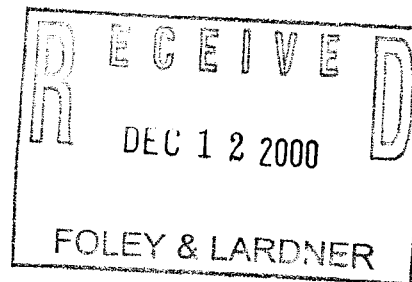

Title

Zoom and pan imaging design tool

Preliminary Class

Data entry by : WASHINGTON, JAMES

Team : OIPE

Date: 12/04/2000



**LICENSE FOR FOREIGN FILING UNDER
Title 35, United States Code, Section 184
Title 37, Code of Federal Regulations, 5.11 & 5.15**

GRANTED

The applicant has been granted a license under 35 U.S.C. 184, if the phrase "IF REQUIRED, FOREIGN FILING LICENSE GRANTED" followed by a date appears on this form. Such licenses are issued in all applications where the conditions for issuance of a license have been met, regardless of whether or not a license may be required as set forth in 37 CFR 5.15. The scope and limitations of this license are set forth in 37 CFR 5.15(a) unless an earlier license has been issued under 37 CFR 5.15(b). The license is subject to revocation upon written notification. The date indicated is the effective date of the license, unless an earlier license of similar scope has been granted under 37 CFR 5.13 or 5.14.

This license is to be retained by the licensee and may be used at any time on or after the effective date thereof unless it is revoked. This license is automatically transferred to any related applications(s) filed under 36 CFR 1.53(d). This license is not retroactive.

The grant of a license does not in any way lessen the responsibility of a licensee for the security of the subject matter as imposed by any Government contract or the provisions of existing laws relating to espionage and the national security or the export of technical data. Licensees should apprise themselves of current regulations especially with respect to certain countries, of other agencies, particularly the Office of Defense Trade Controls, Department of State (with respect to Arms, Munitions and Implements of War (22 CFR 121-128)); the Office of Export Administration, Department of Commerce (15 CFR 370.10 (j)); the Office of Foreign Assets Control, Department of Treasury (31 CFR Parts 500+) and the Department of Energy.

NOT GRANTED

No license under 35 U.S.C. 184 has been granted at this time, if the phrase "IF REQUIRED, FOREIGN FILING LICENSE GRANTED" DOES NOT appear on this form. Applicant may still petition for a license under 37 CFR 5.12, if a license is desired before the expiration of 6 months from the filing date of the application. If 6 months has lapsed from the filing date of this application and the licensee has not received any indication of a secrecy order under 35 U.S.C. 181, the licensee may foreign file the application pursuant to 37 CFR 5.15 (b).

PLEASE NOTE the following information about the Filing Receipt:

- The articles such as "a," "an" and "the" are not included as the first words in the title of an application. They are considered to be unnecessary to the understanding of the title.
- The words "new," "improved," "improvements in" or "relating to" are not included as first words in the title of an application because a patent application, by nature, is a new idea or improvement.
- The title may be truncated if it consists of more than 600 characters (letters and spaces combined).
- The docket number allows a maximum of 25 characters.
- If your application was submitted under 37 CFR 1.10, your filing date should be the "date in" found on the Express Mail label. If there is a discrepancy, you should submit a request for a corrected Filing Receipt along with a copy of the Express Mail label showing the "date in."
- The title is recorded in sentence case.

Any corrections that may need to be done to your Filing Receipt should be directed to:

Assistant Commissioner for Patents
Office of Initial Patent Examination
Customer Service Center
Washington, DC 20231

IN THE UNITED STATES PATENT AND TRADEMARK OFFICE

Applicant: Brian G. Utley
Title: Zoom and Pan Imaging Design Tool
Appl. No.: Unknown
Filing Date: 9/18/2000
Examiner: Unknown
Art Unit: Unknown

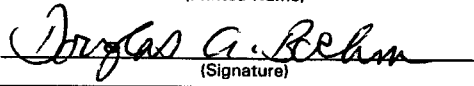
CERTIFICATE OF EXPRESS MAILING	
I hereby certify that this correspondence is being deposited with the United States Postal Service's "Express Mail Post Office To Addressee" service under 37 C.F.R. § 1.10 on the date indicated below and is addressed to: Assistant Commissioner for Patents, Washington, D.C. 20231.	
EL640465729US	9/18/00
<small>(Express Mail Label Number)</small>	<small>(Date of Deposit)</small>
Douglas A. Boehm	
<small>(Printed Name)</small>	
	
<small>(Signature)</small>	

PROVISIONAL PATENT APPLICATION
TRANSMITTAL

Assistant Commissioner for Patents
Box PROVISIONAL PATENT APPLICATION
Washington, D.C. 20231

Sir:

Transmitted herewith for filing under 37 C.F.R. § 1.53(c) is the provisional patent application of:

Brian G. Utley
1930 S.W. 8th Street
Boca Raton, Florida 33486

Enclosed are:

- Specification, Claim(s), Abstract, and Figures(¹¹²~~105~~ pages).
- Assignment of the invention to lviewit.com, Inc..
- Small Entity statement.

The filing fee is calculated below:

	Rate	Fee Totals
Basic Fee	\$150.00	\$150.00
[X] Small Entity Fees Apply (subtract 1/2 of above):	=	\$75.00
TOTAL FILING FEE:		= \$75.00

- [] A check in the amount of \$75.00 to cover the filing fee is enclosed.
- [X] The required filing fees are not enclosed but will be submitted in response to the Notice to File Missing Parts of Application.
- [] The Assistant Commissioner is hereby authorized to charge any additional fees which may be required regarding this application under 37 C.F.R. §§ 1.16-1.17, or credit any overpayment, to Deposit Account No. 06-1447. Should no proper payment be enclosed herewith, as by a check being in the wrong amount, unsigned, post-dated, otherwise improper or informal or even entirely missing, the Assistant Commissioner is authorized to charge the unpaid amount to Deposit Account No. 06-1447.

Please direct all correspondence to the undersigned attorney or agent at the address indicated below.

Respectfully submitted,

Date 9/18/00

By Douglas A. Boehm

FOLEY & LARDNER
 Firststar Center
 777 East Wisconsin Avenue
 Milwaukee, Wisconsin 53202-5367
 Telephone: (414) 297-5718
 Facsimile: (414) 297-4900

Douglas A. Boehm
 Attorney for Applicant
 Registration No. 32,014

Title: Zoom and Pan Imaging Design Tool
Inventor(s): Utley
Appl. No.: Unknown

Dkt. No. 57103/123
DABO (9/18/00)

- Transmittal of Patent Application (2 pgs.); ¹¹²~~115~~
- Patent Application Specification and Figures (~~115~~ pgs.);

Assistant Commissioner for Patents:
Please acknowledge receipt of the above-identified documents by applying the U.S. Patent and Trademark Office receipt stamp hereto and mailing this card.

Respectfully,
Foley & Lardner

Title: Zoom and Pan Imaging Design Tool
Inventor(s): Utley
Appl. No.: Unknown

Dkt. No. 57103/123
DABO (9/18/00)

- Transmittal of Patent Application (2 pgs.); ¹¹²
- Patent Application Specification and Figures (~~115~~ pgs.);

Assistant Commissioner for Patents:
Please acknowledge receipt of the above-identified documents by applying the U.S. Patent and Trademark Office receipt stamp hereto and mailing this card.

Respectfully,
Foley & Lardner

JC541 U.S. PTO
60/233341

09/18/00

FOREIGN FILING	
FFR 6	<u>18 MR 2001</u>
FFR 9	<u>18 JE 2001</u>
FFR 11	<u>18 AU 2001</u>
FFD	<u>09 SE 2001</u>
INITIALS	<u>K</u> DATE <u>9/20/00</u>

10/5/00

**POST OFFICE
TO ADDRESSEE**



UNITED STATES POSTAL SERVICE™

ORIGIN (POSTAL USE ONLY)

PO ZIP Code: 53203
 Day of Delivery: Next Second
 Date In: 9/18/00
 No.: 2176
 Time In: 4:15 PM
 Weight: 4.8 oz
 Flat Rate Envelope:
 Postage: \$
 Return Receipt Fee: \$
 COD Fee: \$
 Total Postage & Fees: \$
 Int'l Alpha Country Code:
 Insurance:
 Accepted: Initials:
 No Delivery: Weekend Holiday

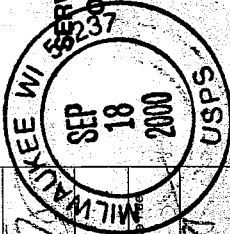

SEE REVERSE SIDE FOR
SERVICE GUARANTEE AND LIMITS
ON INSURANCE COVERAGE

EL640465729US

Customer Copy Label 11-F July 1997



9US*
29US

Mailing Label 11-F July 1997

Signature _____
 Signature _____
 Signature _____
 Signature _____
 Signature _____

48/ 300
F02
T

CUSTOMER USE ONLY
 METHOD OF PAYMENT: X532756
 Federal Agency Acct. No. or Postal Service Acct. No.:
 FROM: (PLEASE PRINT) FOLEY & LARDNER 777 E WISCONSIN AVE STE 3800 MILWAUKEE WI 53202-5367
 PHONE: (414) 377-5718
 TO: (PLEASE PRINT) BOX PROVISIONAL PATENT APPLICATION ASSISTANT COMMISSIONER OF PATENTS WASHINGTON DC 20231
 PHONE: _____
 WWW.USPS.GOV

FOR PICKUP OR TRACKING CALL 1-800-222-1811
 WWW.USPS.GOV
 PRESS HARD. You are making 3 copies.
 FOLEY & LARDNER AVE STE 3800
 777 E WISCONSIN AVE STE 3800-5367
 MILWAUKEE
 57103/123
 FOR PICKUP OR TRACKING CALL 1-800-222-1811
 WWW.USPS.GOV

BOX PROVISIONAL PATENT APPLICATION
 ASSISTANT COMMISSIONER OF PATENTS
 WASHINGTON DC 20231



WWW.USPS.GOV

U.S. PROVISIONAL PATENT APPLICATION

for

**ZOOM AND PAN IMAGING
DESIGN TOOL**

Inventors:

**Brian G. Utley
1930 SW 8th Street
Boca Raton, FLORIDA 33486
Citizenship: U.S.**

**FOLEY & LARDNER
Attorneys at Law
777 E. Wisconsin Avenue
Milwaukee, Wisconsin 53202
(414) 271-2400**

**ZOOM AND PAN IMAGING
DESIGN TOOL**

CROSS-REFERENCE TO RELATED APPLICATIONS

The present application is related to U.S. Patent Application No. 09/630,939, filed August 2, 2000, and U.S. Provisional Patent Application entitled "Zoom and Pan Imaging Using
5 a Digital Camera" filed on even date herewith, a copy of each is attached hereto and incorporated herein by reference.

FIELD OF THE INVENTION

The present invention is directed to a system and a method for producing enhanced digital images and, in particular, to a
10 design tool for producing enhanced digital images having improved resolution for zooming and/or panning within an image.

BACKGROUND OF THE INVENTION

See Background in related applications.

DESCRIPTION OF THE INVENTION

15 The object of this invention is to provide a design tool for provide pan and zoom capabilities as described in the related applications.

Note that the relationship between the target image and the viewing image is very important, as described in the related
20 applications. By panning the viewing window, every portion of the target image may be viewed from each level of zooming. Zoom capability is provided up to a maximum level where the image begins to pixelate.

The preferred embodiment of the present invention is a computer spreadsheet program written in Microsoft Excel and its associated Visual Basic for Applications (VBA) macro language.

Attached hereto and incorporated by reference herein
5 are the spreadsheets, forms, and VBA program code for the preferred embodiment. Examples are given for different target and source image sizes. The design tool works for both digital and analog source images, but the scan density parameter is not applicable to digital images.

iviewit Imaging Setup

Application Overview

The iviewit proprietary imaging system is designed to provide clear, sharp images which can be zoomed into at great depth, and panned around at the discretion of the viewer, or under program control. The resulting experience is one of immersion into the image and an ability to view detail at a level heretofore not thought possible.

The fundamental concept of the imaging system is the creation of a 'Virtual Image' which is designed to be large enough to provide the level of detailed viewing desired. The Virtual Image is viewed through a 'Viewing Window' which is an allocated space on the user display device. The initial presentation of the image in the viewing window is normally a view of the total image. Since this is smaller than the Virtual Image, the Virtual Image must be scaled down to fit the viewing window. This scaling factor is referred to as the 'Maximum Magnification Factor', since, from the viewers perspective, zooming into the image has the appearance of magnifying the image.

iviewit Imaging Setup

Viewing Window Size in Pixels

Width	640
Height	480
Pixels	307,200

Minimum Image Size in Pixels

Width	600
Height	480
Pixels	288,000

Desired Maximum Magnification

Magnification	5.0
---------------	-----

Virtual Image Size in Pixels

Width	1,342
Height	1,073
Pixels	1,440,000
Bit Map MB	4,104,000

Source Image Size in Pixels

Width	1,500
Height	1,200
Pixels	1,800,000
Bit Map MB	5,130,000

Input Format

Image Format	1500 X 1200
--------------	-------------

Image Orientation

Orientation	Landscape
-------------	-----------

Minimum Scan Density in dpi

Scan Density	N/A
--------------	-----

Start

1. Press "Start" button to initiate program
2. Follow instructions in order to set virtual image size and scan density where applicable.
3. Virtual Image size provides the necessary settings for the JPEG compression of the image. Compression factor should be 80 (Corel Draw).

Copyright by iviewit.com, Inc.

Usage of this program is restricted to authorized iviewit personnel only

iviewit Imaging Setup

Viewing Window Size in Pixels

Width	640
Height	480
Pixels	307,200

Minimum Image Size in Pixels

Width	343
Height	480
Pixels	164,571

Desired Maximum Magnification

Magnification	20.0
---------------	------

Virtual Image Size in Pixels

Width	1,533
Height	2,147
Pixels	3,291,429
Bit Map MB	9,380,571

Source Image Size in Pixels

Width	1,533
Height	2,147
Pixels	3,291,429
Bit Map MB	9,380,571

Input Format

Image Format	5" x 7"
--------------	---------

Image Orientation

Orientation	Portrait
-------------	----------

Minimum Scan Density in dpi

Scan Density	307
--------------	-----

Start

1. Press "Start" button to initiate program
2. Follow instructions in order to set virtual image size and scan density where applicable.
3. Virtual Image size provides the necessary settings for the JPEG compression of the image. Compression factor should be 80 (Corel Draw).

Copyright by iviewit.com, Inc.

Usage of this program is restricted to authorized iviewit personnel only

iviewit Imaging Setup

Viewing Window Size in Pixels

Width	320
Height	240
Pixels	76,800

Minimum Image Size in Pixels

Width	300
Height	240
Pixels	72,000

Desired Maximum Magnification

Magnification	10.0
---------------	------

Virtual Image Size in Pixels

Width	949
Height	759
Pixels	720,000
Bit Map MB	2,052,000

Source Image Size in Pixels

Width	949
Height	759
Pixels	720,000
Bit Map MB	2,052,000

Input Format

Image Format	8" x 10"
--------------	----------

Image Orientation

Orientation	Landscape
-------------	-----------

Minimum Scan Density in dpi

Scan Density	95
--------------	----



1. Press "Start" button to initiate program
2. Follow instructions in order to set virtual image size and scan density where applicable.
3. Virtual Image size provides the necessary settings for the JPEG compression of the image. Compression factor should be 80 (Corel Draw).

Copyright by iviewit.com, Inc.

Usage of this program is restricted to authorized iviewit personnel only

Dlgframe

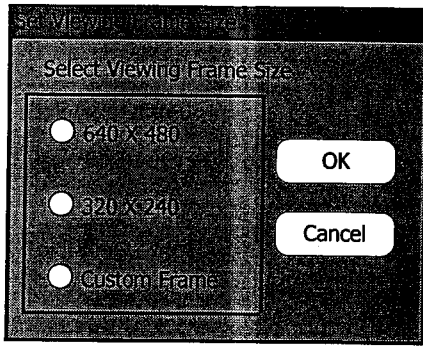

dlgframe1

Custom Frame Size

ENTER CUSTOM FRAME SIZE IN
PIXELS

WIDTH	HEIGHT
800	600

OK

Cancel

Source Image Size

<input checked="" type="radio"/> 35mm	<input type="radio"/> 4x5
<input type="radio"/> 6cm x 6cm	<input type="radio"/> 5x7
<input type="radio"/> 6cm x 9cm	<input type="radio"/> 8x10
<input type="radio"/> Digital	<input type="radio"/> Other

Select Input Format

<input checked="" type="radio"/> Landscape	<input type="radio"/> Portrait
--	--------------------------------

Select Orientation

OK

Cancel

dlgsource1

Special Image Size

ENTER SPECIAL IMAGE SIZE IN INCHES

WIDTH	HEIGHT	
<input type="text" value="10"/>	<input type="text" value="4"/>	<input type="button" value="OK"/>
		<input type="button" value="Cancel"/>

Digital Image Size

ENTER DIGITAL IMAGE SIZE
IN PIXELS

WIDTH	HEIGHT	
1500	1200	OK
		Cancel

dlgmag

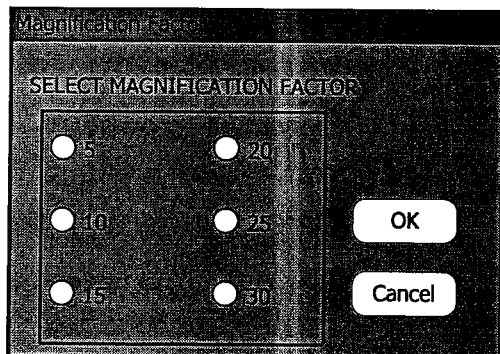

Module1 - 1'

Dim rtmag As Variant

Copywrite by iviewit.com, Inc.

Button3_Click Macro

Start button from sheet 1

Sub startbutton_Click()

```
icancel = 0 'initialize cancel button state
framew = Range("framewidth").Value 'capture current frame size
frameh = Range("frameheight").Value
'set dlgframe dialog box radio button to 1st button
Range("framewidth").Value = 1
DialogSheets("dlgframe").Show
If icancel = 1 Then 'Test for cancel button
    Range("framewidth").Value = framew
    GoTo cancelop
End If
'check for frame selection and set up framew and frameh
framecase = Range("framewidth").Value
Select Case framecase 'Determine viewing frame size
    Case 1 '640 X 480
        Range("framewidth").Value = 640
        framew = 640
        Range("frameheight").Value = 480
        frameh = 480
    Case 2 '320 X 240
        Range("framewidth").Value = 320
        framew = 320
        Range("frameheight").Value = 240
        frameh = 240
    Case 3 'Custom Frame
        'set up custom frame dimensions in dialog box from last frame defined
        DialogSheets("Dlframe1").EditBoxes("Edit Box 5").Text = framew
        DialogSheets("Dlframe1").EditBoxes("Edit Box 6").Text = frameh
        'show custom frame dialog box
        DialogSheets("dlgframe1").Show
        If icancel = 1 Then 'Test for cancel button
            Range("framewidth").Value = framew
            GoTo cancelop
        End If
        framew = DialogSheets("Dlframe1").EditBoxes("Edit Box 5").Text
        frameh = DialogSheets("Dlframe1").EditBoxes("Edit Box 6").Text
        Range("framewidth").Value = framew
        Range("frameheight") = frameh
End Select
'initialize orientation and source format in dialog box
Range("orient").Value = 1
Range("informat").Value = 1
'show source dialog box
DialogSheets("dlgsources").Show
If icancel = 1 Then 'Test for cancel button
    GoTo cancelop
End If
formatno = Range("informat").Value 'formatno specifies the source format radio button
Select Case formatno
    Case 1 '35mm
        sourcew = 15 / 8
        sourceh = 15 / 16
        Range("informat").Value = "35mm"
    Case 2 '6cm x 6cm
        sourcew = 6 / 2.54
        sourceh = 6 / 2.54
        Range("informat").Value = "6cm x 6cm"
    Case 3 '6cm x 9cm
        sourcew = 9 / 2.54
        sourceh = 6 / 2.54
        Range("informat").Value = "6cm x 9cm"
    Case 4 '4 x 5
        sourcew = 5
        sourceh = 4
```

```

Range("informat").Value = "4" x 5""
Case 5      '5 x 7
  sourcew = 7
  sourceh = 5
  Range("informat").Value = "5" x 7""
Case 6      '8 x 10
  sourcew = 10
  sourceh = 8
  Range("informat").Value = "8" x 10""
Case 7      'digital input format
  DialogSheets("dlgsource2").Show
  If icancel = 1 Then      'Test for cancel button
    GoTo cancelop
  End If
  sourcew = DialogSheets("Dlgsource2").EditBoxes("Edit Box 4").Text
  sourceh = DialogSheets("Dlgsource2").EditBoxes("Edit Box 5").Text
  Range("informat").Value = sourcew & " X " & sourceh
Case 8      'Special input source image size
  DialogSheets("dlgsource1").Show
  If icancel = 1 Then      'Test for cancel button
    GoTo cancelop
  End If
  sourcew = DialogSheets("Dlgsource1").EditBoxes("Edit Box 7").Text
  sourceh = DialogSheets("Dlgsource1").EditBoxes("Edit Box 8").Text
  Range("informat").Value = sourcew & "" X " & sourceh & ""

```

End Select

'check for image orientation

If Range("orient").Value = 1 Then

Range("orient").Value = "Landscape"

Else

Range("orient").Value = "Portrait"

width 'if orientation is not landscape and "other" input was not selected then swap height and

If formatno < 8 Then

temp = sourcew

sourcew = sourceh

sourceh = temp

End If

End If

'get ratio of hieght to width for source and target

frameratio = frameh / framew

sourceratio = sourceh / sourcew

'initialize magnification value in dialog box to 10

Range("magfactor").Value = 2

DialogSheets("dlgmag").Show

If icancel = 1 Then 'Test for cancel button

GoTo cancelop

End If

'multiply the radio button for magnification factor by 5 to obtain real magnification factor

magtgt = Range("magfactor").Value * 5

Range("magfactor").Value = magtgt 'put magnification factor into spread sheet

width 'determine aspect ratio of source relative to target to determine whethe fit is to height or

width 'determine size of the target image based upon multiplying the used partion of the window ne

glecting 'unused portions of the minimum image size

If frameratio > sourceratio Then

'image width is equal to frame width and image height is equal to frame with * image rat

io

tgtw = framew * Sqr(magtgt)

tgth = tgtw * sourceratio

Range("minimagerw").Value = framew

Range("minimagerh").Value = framew * sourceratio

minimagesize = framew * framew * sourceratio

Else

'frame height is maximum

tgth = frameh * Sqr(magtgt)

tgtw = tgth * sourcew / sourceh

Range("minimagerh").Value = frameh

Module1 - 3'

```
Range("minimagew").Value = framew * sourcew / sourceh  
minimagesize = framew * framew * 1 / sourceratio
```

```
End If
```

```
'insert values into spread sheet
```

```
Range("tgtw").Value = tgtw
```

```
Range("tgth").Value = tgth
```

```
'scan ppi is equal to target pels divided by the source image in inches
```

```
scanppi = tgth / (sourceh)
```

```
Range("scantgt").Value = scanppi
```

```
Range("sourceh").Value = sourceh * scanppi
```

```
Range("sourcew").Value = sourcew * scanppi
```

```
If formatno = 7 Then
```

```
Range("sourceh").Value = sourceh
```

```
Range("sourcew").Value = sourcew
```

```
Range("scantgt").Value = "N/A"
```

```
If tgtw * tgth > sourcew * sourceh Then
```

```
Range("tgtw").Value = sourcew
```

```
Range("tgth").Value = sourceh
```

```
Range("magfactor").Value = sourceh * sourcew / minimagesize
```

```
End If
```

```
End If
```

```
cancelop:
```

```
End Sub
```

Module2,- 1"

Public icancel As Integer

' Button2_Click Macro
' OK button

Sub Button2_Click()
End Sub

' Button3_Click Macro

Sub Button3_Click()
icancel = 1
End Sub

Copy

U.S. PATENT APPLICATION

for

**SYSTEM AND METHOD FOR PROVIDING AN
ENHANCED DIGITAL IMAGE FILE**

U.S. Application No.: 09/630939
U.S. Filing Date: August 2, 2000

Inventors: Eliot I. Bernstein
500 S.E. Mizner Boulevard
Boca Raton, FLORIDA 33432
Citizenship: U.S.

Brian G. Utley
1930 SW 8th Street
Boca Raton, FLORIDA 33486
Citizenship: U.S.

FOLEY & LARDNER
Attorneys at Law
777 E. Wisconsin Avenue
Milwaukee, Wisconsin 53202
(414) 271-2400

U.S. PATENT APPLICATION

for

**SYSTEM AND METHOD FOR PROVIDING AN
ENHANCED DIGITAL IMAGE FILE**

Inventors: Eliot I. Bernstein
500 S.E. Mizner Boulevard
Boca Raton, FLORIDA 33432
Citizenship: U.S.

Brian G. Utley
1930 SW 8th Street
Boca Raton, FLORIDA 33486
Citizenship: U.S.

FOLEY & LARDNER
Attorneys at Law
777 E. Wisconsin Avenue
Milwaukee, Wisconsin 53202
(414) 271-2400

**SYSTEM AND METHOD FOR PROVIDING AN
ENHANCED DIGITAL IMAGE FILE**

CROSS-REFERENCE TO RELATED APPLICATIONS

The present application is a continuation-in-part of U.S. Patent Application No. 09/522,721, filed March 10, 2000, which claims the benefit of priority from U.S. Provisional Application No. 60/125,824, filed March 24, 1999. The present application also
5 claims the benefit of priority from U.S. Provisional Application Nos. 60/146,726, filed August 2, 1999, 60/149,737, filed August 19, 1999, 60/155,404, filed September 22, 1999, and 60/169,559, filed December 8, 1999.

10 **FIELD OF THE INVENTION**

The present invention is directed to a system and a method for producing enhanced digital images and, in particular, to a system and a method for producing enhanced digital images having improved resolution for zooming and/or panning within a single file.

15 **BACKGROUND OF THE INVENTION**

In the field of digital imaging, the primary design challenge is that the viewer desires ideal image quality delivered to the viewer's display system. In a limited-bandwidth network, such as the Internet, it is important to transfer the image data in a
20 reasonable amount of time. However, ideal image quality requires an enormous amount of digital data. Today's networks are not capable of transferring an ideal digital image in a reasonable time.

It is known that one can view a digital image on a display screen and "zoom" (i.e., magnify a portion of an image and

appearing to move into the image) and "pan" (i.e., move across or around within the plane of that image). However, prior attempts have failed to produce high-quality, high-resolution digital images having the ability to zoom within the image and pan around the image without pixelation. "Pixelation" generally refers to the effect a digital image has when magnified, in which the pixels (i.e., picture elements) comprising the image become readily apparent to the human eye. More specifically, pixelation occurs when more than one pixel of the display monitor is used to represent one pixel of information of the digitized source image. In prior digital image systems, when the image is magnified, pixelation occurs almost immediately and is very noticeable to the user as a substantial degradation in the quality of the image.

As used herein, the term "pixel" refers to the smallest resolvable element of an image, either on a screen or stored in memory. Each pixel in a monochrome image has its own brightness, from 0 for black to the maximum value (e.g., 255 for an eight-bit pixel) for white. In a color image, each pixel has its own brightness and color, usually represented as a triplet of red, green, and blue intensities.

The teaching in the art is to generate a digital image file having the same number of pixels, or less, as the number that can be shown in a target viewing window. This results in a small source image file size, thereby speeding the transmission of the image file across a network. The target viewing window is typically maintained very small, e.g., 160 x 120 pixels, to further limit the number of pixels needed in the digital image file. Thus, the teaching in the art is to reduce the number of pixels in the digital image file to decrease the size of the image file before compression, so that the

compressed image file can be more quickly transmitted over a limited-bandwidth network. However, this teaching has been unsatisfactory in providing high-resolution digital images. It has also been unsatisfactory in providing digital images in large viewing
5 screens, such as, for example, full-sized VGA display monitor screens of 640 x 480 pixels.

Another example of prior systems is mapping or travel web sites. A user selects a desired location and the mapping web site responds by downloading map data from a map database.
10 When the user wishes to zoom into or pan around the selected location, the web site retrieves additional source data, e.g., additional new map images, and sends it to the user computer. One drawback of this type of system is that each zoom or pan operation requires the downloading of additional data over the network
15 connection. This method is slow, and does not allow the user to zoom and pan around a set of data unless the network connection is maintained.

Accordingly, there is a need for a system and a method for providing enhanced digital images. Further, there is a need for a
20 system and a method for providing enhanced digital images within which a user can zoom or pan without loss of resolution and without pixelation. Further still, there is a need for a system and method for providing enhanced digital images that can be transmitted over a network in a reasonable amount of time. Further yet, there is a need
25 for a system and a method for producing enhanced digital images suitable for uploading and for downloading to a display. Also, there is a need for a system and method for providing a digital image file suitable for efficient file transfers of high resolution digital images,

thereby dispensing with the need to engage in long and slow, conventional file downloads in order to maintain viewing quality.

SUMMARY OF THE INVENTION

According to an exemplary embodiment, a method of providing a digital image file for viewing in a viewing window of a user display, the viewing window having a predetermined size, includes providing a digital image file having an image size comprising a fixed number of pixels representative of an image. The image size to be displayed is greater than that of the predetermined viewing window size. The method further includes the step of associating a user interface with the digital image file. The user interface is configured to display the digital image file in the viewing window and to allow a user to zoom into the image displayed in the viewing window.

According to another exemplary embodiment, a method of providing an enhanced digitized image file to a user includes predefining a viewing window size in which the digitized image file is to be displayed to a user; providing a digitized image file having an image size greater than of the predefined viewing window size; compressing the digitized image file; and providing the compressed image file to a network server.

According to yet another exemplary embodiment, an enhanced digital image file is disclosed. The enhanced digital image file is displayed on a client computer display system having a viewing window, the viewing window having a predetermined frame size. The enhanced digital image file includes digitized image data representative of an image, wherein the digitized image data has a number of pixels sufficient to allow a user to magnify the digitized

image in the viewing window by a magnification factor of greater than one without appreciable pixelation. The enhanced digital image file further includes control data associated therewith for permitting the user to control the magnification factor.

5 BRIEF DESCRIPTION OF THE DRAWINGS

The invention will become more fully understood from the following detailed description, taken in conjunction with the accompanying drawings, wherein like reference numerals refer to like parts, in which:

10 FIG. 1 is a block diagram of a system for providing an enhanced digital image file according to an exemplary embodiment;

FIG. 2 is a flowchart of a method for providing an enhanced digital image file from a print film image according to an exemplary embodiment;

15 FIG. 3 is a screen print of a display screen on a user display illustrating an enhanced digital image file according to an exemplary embodiment;

20 FIG. 4 is a screen print of a display screen on a user display illustrating a zoomed view of the enhanced digital image of FIG. 3;

FIG. 5 is a screen print of a display screen on a user display illustrating a panned and zoomed view of the enhanced digital image of FIG. 3;

25 FIG. 6 is a flowchart of a method for providing an enhanced digital image file from a digital image according to an exemplary embodiment; and

FIG. 7 is an illustration relating a source image, a viewing image, and a viewing window to one another.

DETAILED DESCRIPTION OF THE INVENTION

FIG. 1 illustrates a system 10 for providing an enhanced digital image file according to an exemplary embodiment. System 10 includes a camera 12 which may be a conventional print film camera, such as, print film cameras manufactured by Nikon, Canon, Hasselblad, Kodak, or other manufacturers, or may alternatively be a digital camera, a digital video recording device (e.g., including 3CCD technology), an analog recording device such as a reel-to-reel recording device, a live video recording system, etc. In the case where camera 12 is a digital camera, camera 12 may further include a solid state storage medium or memory. Camera 12 may be mountable, such as on a tripod or on a stand, hand-held or fixed, and may include a 24-32 mm lens. Camera 12 is utilized to obtain an image of a scene that is being photographed or video recorded. The image may be a print film image (e.g., a high gloss, photographic print), analog image, digital image, negative, transparency, etc.

As a further alternative, system 10 may be utilized in conjunction with any imaging or video recording system, such as, medical imaging equipment. In this case, camera 12 may be an imaging device, such as a magnetic resonance imaging (MRI) device, an X-ray device, a microscope with a camera attached thereto, etc.

In the case where camera 12 is a print film camera, system 10 also includes a developing device 14, which can be any device or collection of devices, for developing the print film image taken by camera 12. In some cases, such as a POLAROID brand camera, developing device 14 is combined with and integral to camera 12. Developing device 14 is not required in an embodiment in which the image is a digital image.

System 10 also includes an enlarging device 16 for enlarging the image which is developed by developing device 14. The image may be photographically enlarged from a print film image, a negative, or other transparency.

5 The system of FIG. 1 further includes a scanning device 18, for scanning images or photographs in order to obtain a digitized representation of the source image in the form of a digital image file. Any suitable scanning software may be utilized. In an exemplary embodiment, a UMAX Astra scanner is utilized in conjunction with
10 Microsoft Photo Editor software. Scanning device 18 outputs the digital image file in a bitmapped format (e.g., BMP, TIF, GIF, etc.) The device may include compression software to compress the digital image file into a compressed format (e.g., JPEG). Note that, depending upon the specific type of camera 12 and desired
15 processing steps, a print film image from camera 12 may be provided directly to enlarging device 16 or directly to scanning device 18.

If the source image is obtained with a digital camera of sufficient resolution, the digitized image file from camera 12 may be
20 used directly without first creating a print image. On the other hand, a print image may first be obtained from the camera's digitized source image by sending it to a suitable printing device 20. In this manner, the printed image can then be optically enlarged and scanned to provide the enhanced digitized image.

25 System 10 also includes a computer 22 configured to process the digital image file created by the above-mentioned devices. Computer 22 may be a personal computer, a laptop computer, a mini computer, a microprocessor, a mainframe computer, a network computer, a server computer, or any other

suitable computer or computer system. Computer 22 typically includes a central processing unit (CPU), a read only memory (ROM), a random access memory (RAM), a display device such as an SVGA display monitor, an input device and/or an output device. Computer 22 may also include any other hardware device, peripheral device, or software necessary to perform the functions described herein. The input device may include a keyboard, a mouse, or other pointing device, or other devices for allowing user input. The output device may include a printer (e.g., a black-and-white or color laser or inkjet printer). Computer 22 also includes an interface circuit for transmitting and/or receiving data over a network or link 24, such as, a local area network (LAN), a wide area network (WAN), an internet protocol network (e.g., the Internet, an intranet), a broadcast network, a satellite or cable television network, a digital video transmission path, etc. Computer 22 may further act as a network server or may be in communication with such a network server. Furthermore, as will be seen below, the function of network 24 may be, in a simple case, performed by other components of the system. In this exemplary embodiment, computer 22 is accessible by the Internet 26 via network 24 (e.g., a local area network).

A user computer 28 is used to access the enhanced digital image file stored in or provided by computer 22 (acting as a network server). Computer 28 may also load the image file to a storage device (e.g., a hard disk drive) to be used for display on a display 30. User computer 28 may operate an Internet browser, such as Netscape Navigator configured to communicate with the Internet 26 or an intranet or other network.

Display 30 may be any type of user display, such as a cathode ray tube (CRT), liquid crystal display (LCD), hand-held

personal digital assistant (PDA) display, mobile phone display, etc. Display 30 normally has a predetermined display resolution (e.g., 1,280 x 1,024 pixels, 640 x 480 pixels, 320 x 240 pixels, etc.). Note that user computer 28 may be combined with display 30 in a single, integrated system, such as would be the case for a WebTV brand system, a high-definition television (HDTV), a PDA, etc. The combined user computer and display system may be referred to herein as the display system.

As will be described in more detail below, the computer display system typically has a viewing window on the display for viewing the image in a particular frame. The viewing window may be all or a portion of the total viewing area of display 30. The viewing window parameters, such as the viewing window area size and aspect ratio (i.e., viewing window width divided by viewing window height) may be under the control of user computer 28. In one embodiment, the viewing window area may be no more than 160 x 120 pixels in size, which is just a portion of the display area of an SVGA display monitor at 800 x 600 pixels.

References herein to frame sizes in pixels (such as, 320 x 240 pixels, 640 x 480 pixels, etc.) are intended to include equivalent frame sizes thereto. As an example, when rectangular pixels are used, the exact pixel count differs from the stated frame size. Thus, one equivalent to a 320 x 240 pixel frame size is 352 x 240. Accordingly, references to frame sizes in pixels are intended to include these and other equivalent frame sizes, and the teachings herein include any and all such insubstantial variations.

Referring now to FIGS. 2 and 6, exemplary methods 50 and 100 of providing an enhanced digital image file will be described. The enhanced digital image file can be generated from a

print film image or a digital image. The enhanced digital image file is a digitized image acquired with a digital camera, scanner, or other device suitable for digitizing an image into pixels. The method of FIG. 2 is suitable for processing a print film image; the method of FIG. 6 is suitable for processing a digital image.

At step 52 of FIG. 2, an image is photographed or recorded by using camera 12. If camera 12 is a video camera, the video data is captured using a suitable capture device (e.g., an internal or external capture card, a Dazzle LAV-1000S capture device manufactured by Dazzle, Inc. of Fremont, California, etc.). A single captured frame from the video camera may be further processed as a digital image.

At step 54, the image is developed by developing device 14 in order to produce a photographic print, such as a high gloss photographic print. As mentioned, the step of developing may not be necessary in all cases (e.g., where the print film image of camera 12 is in a suitable format for subsequent enlarging or scanning).

At step 56, the developed image is enlarged by enlarging device 16, if needed. In this exemplary embodiment, the developed image can be enlarged to sizes of between 8"x6" and 8"x12", or to any other appropriate size. The developed image is enlarged to provide additional photo information to scanning device 18. The developed image can be enlarged many times before the granularity of the image is visible to the human eye. A photographic enlargement magnification capability of up to 1700 times or more may be attained for most views or scenes. It is, however, recommended that larger enlargement sizes be obtained for smaller developed images. As mentioned, the step of enlarging may not be

necessary in all cases (e.g., where the size of the print film image or developed image is large enough to provide sufficient data to scanning device 18).

At step 58, the enlarged image is scanned by scanning
5 device 18 in order to generate a bitmap image file or other digital
image file, such as, JPEG, GIF, or other files. Scanning should be
performed at a scan density that will provide the requisite number of
pixels in the resulting digital image file (e.g., 100 dpi, 200 dpi, 600
dpi, 1400 dpi, etc.) Contrary to the teachings of the prior art, a
10 large number of pixels are provided in the digital image file such as
would be within the particular file size and loading time constraints.
According to one example, a sufficient number of pixels are provided
in the enhanced digital image file to allow a user to magnify the
digitized image in the viewing window of display 30 by a
15 magnification factor of greater than one without pixelation.
Alternatively, a sufficient number of pixels are provided to allow the
user to magnify the digitized image by a magnification factor of 1.5,
5, 10, 20, 100, or more.

According to one exemplary embodiment, the number
20 of pixels provided in the enhanced digital image file is based on a
viewing window size and the desired magnification ratio. By
providing more pixels in the enhanced digital image file than is
required for a full-window view in the viewing window, the user is
able to zoom and pan within the digital image during viewing without
25 pixelation.

FIG. 7 illustrates the parametric details and relationships
between the different images and viewing window sizes. These
parameters and description are for the purpose of creating large, clear,
zoomable and pannable images from a variety of photographic,

source images. First, a "source image" (si) provides the original source of the graphical image information before it is digitally processed, as opposed to a "target image" (ti) that is the destination image to be transferred to the computer display system. In the analog case, the source image is not yet digitized. In other words, it has not been converted to a bitmapped format. A source image could be a photograph, a handwritten sketch, a computer-generated graphic, etc. In this case, source image is what is fed to the scanning device 18. In the digital case, the source image has already been digitized, such as the digital output of a CCD camera taking a photograph.

The source image (si) has a source image height (sih) and a source image width (siw). The source image aspect ratio (sir) is the width of the image divided by the height of the image, generally in inches:

$$\text{sir} = \text{siw}/\text{sih}$$

The viewing window (vw) is the window, defined in pixels, within which the target image, when scaled to fit, is to be displayed as the viewing image (vi). The viewing window (vw) has a viewing window width (vww) and a viewing window height (vwh), both defined in pixels. Thus, the viewing window aspect ratio (vwr) can be determined as:

$$\text{vwr} = \text{vww}/\text{vwh}$$

Note that the source image (si) may have a different aspect ratio than the viewing window (vw). To place the viewing image (vi) in the viewing window (vw), a subset of pixels from the source image (si) must be selected and scaled. The viewing image height (vih) and viewing image width (viw) within the viewing window (vw) can be determined by comparing the source image

aspect ratio (sir) to the viewing window aspect ratio (vwr), as shown:

if $sir < vwr$ then:

$$vih = vwh$$

5

$$viw = vih * sir$$

but if $sir \geq vwr$ then:

$$viw = vww$$

$$vih = viw / sir$$

This relationship is illustrated in FIG. 7.

10 Note that the target image (ti) is created from the source image (si), by scaling the image (si) down to fit within the viewing window (vw). When the target image (ti) is scaled down by the desired maximum magnification factor (mmf) to fit within the viewing window (vw), the scaled target image is called the viewing
15 image (vi).

The maximum magnification factor (mmf) is defined as the ratio of the target image area (tia) to the viewing image area (via). This ratio will determine the amount of zoom available without causing the image to distort due to pixelation, i.e., when fewer
20 pixels are in the viewing image being displayed than available in the viewing window. So:

$$\text{target image area (tia)} = tiw \times tih$$

and since

$$via = viw \times vih$$

25 then

$$tia = via \times mmf$$

To obtain the target image width and height:

$$tiw = \sqrt{\text{tia} * sir}$$

$$tih = tiw / sir$$

The relationship between the target image and the viewing image is shown in FIG. 7. The relationship between the target image and the viewing window is also shown. A zoom to the maximum level will be shown in the viewing window as illustrated at representation 120 of FIG. 7. By panning the viewing window, every portion of the target image may be viewed from each level of zooming.

To determine the minimum scan density (msd) to avoid pixelation at the desired maximum magnification factor (mmf):

$$\text{msd} = t_{ih}/s_{ih} = t_{iw}/s_{iw}$$

EXAMPLE 1

Determine the Target Image Area and dimensions, and minimum scan density for the following case:

Source Image = 5" wide x 4" high

Desired Magnification Factor = 20

Source Image Aspect Ratio = 5 / 4 = 1.25

Define the Viewing Window: assume 480w x 320h pixels

Viewing Window Aspect Ratio = 480 / 320 = 1.5

The Source Image Aspect Ratio is < the Viewing Window Aspect Ratio:

1.25 < 1.5 therefore:

$$v_{ih} = v_{wh} = 320 \text{ pixels}$$

$$v_{iw} = v_{wh} \cdot 1.25 = 320 \cdot 1.25 = 400 \text{ pixels}$$

The Viewing Image Area = $v_{is} = 320 \times 400 = 128,000$ pixels

The Target Image Area = $v_{is} \times 20 = 128,000 \times 20 = 2,560,000$

pixels

$$\text{The Target Image width} = \sqrt{2,560,000 / 0.8} = 1789 \text{ pixels}$$

$$\text{The Target Image height} = 1789 \times 0.8 = 1431 \text{ pixels}$$

The Minimum Scan Density = $1789 / 5 = 358$ pixels per inch
 The photo scan can be any scan density > 357 pixels per inch

Thus, a 5 x 4" print film image should be scanned at
 5 greater than 357 pixels per inch to allow magnification/zoom up to
 20 times in a viewing window of ^{480 x 320}~~320 x 240~~ pixels. An enhanced
 digital image file having 2,560,000 pixels provides a sufficient
 number of pixels for this example.

EXAMPLE 2

10 Determine the Target Image Area and dimensions, and minimum scan
 density for the following case:

Source Image = 5" x 4" ^{wide} _{high}

Desired Maximum Magnification Factor = 20

Source Image Aspect Ratio = $5 / 4 = 1.25$

15 Define the Viewing Window: assume 400w x 360h pixels

Viewing Window Aspect Ratio = $400 / 360 = 1.11$

The Source Image Aspect Ratio is $>$ the Viewing Window Aspect Ratio:

$1.25 > 1.11$ therefore:

$v_{iw} = v_{ww} = 400$ pixels

20 $v_{ih} = v_{iw} / 1.25 = 400 / 1.25 = 320$ pixels

The Viewing Image Area = $v_{ia} = 400 \times 320 = 128,000$ pixels

The Target Image Area = $v_{ia} \times 20 = 128,000 \times 20 = 2,560,000$ pixels

The Target Image width = $\sqrt{2,560,000 \times 1.25} = 1789$ pixels

The Target Image height = $1789 / 1.25 = 1431$ pixels

25 The Minimum Scan Density = $1431 / 4 = 358$ pixels per inch

The photo scan can be any scan density > 357 pixels per inch

EXAMPLE 3

Determine the Target Image Area and dimensions, and minimum scan density for the following case:

Source Image = 4" wide x 5" high (portrait orientation)

Desired Magnification Factor = 20

5 Source Image Aspect Ratio = $4 / 5 = 0.8$

Define the Viewing Window: assume 400w x 360^h pixels

Viewing Window Aspect Ratio = $400 / 360 = 1.11$

The Source Image Aspect Ratio is < the Viewing Window Aspect Ratio:

$0.8 < 1.11$ therefore:

10 $v_{ih} = v_{wh} = 360$ pixels

$v_{iw} = v_{ih} * 0.8 = 360 * 0.8 = 288$ pixels

The Viewing Image area = $v_{ia} = 360 * 288 = 103,680$ pixels

The Target Image area = $v_{ia} * 20 = 103,680 * 20 = 2,073,600$ pixels

The Target Image width = $\sqrt{2,073,600 * 0.8} = 1288$ pixels

15 The Target Image height = $1288 / 0.8 = 1610$ pixels

The Minimum Scan Density = $1610 / 5 = 322$ pixels per inch

The photo scan can be any scan density > 321 pixels per inch

Returning now to FIG. 2, at step 60, the enhanced digital image file is provided to computer 22 in a digitized format, i.e., pixel-based, bitmapped, etc. (as opposed to vector graphics based format), such as in either in a bitmap BMP format or a compressed JPEG format. Computer 22 performs a touch-up operation on the scanned image in order to make refinements or enhancements thereto. This touch-up operation is accomplished by utilizing imaging software. Touch-up steps may include cleaning the edges of the image, adjusting lighting, adjusting colors, etc. Adobe PhotoShop software, manufactured by Adobe Systems Inc., San Jose, California, can be used as the imaging software for touching up the images.

20

25

According to one example, multiple images can be stitched together after scanning, and before or after compression, thereby creating a panoramic scene or image, or simply a scene requiring a plurality of photographs. This stitching operation can be performed by utilizing photo stitching software such as, for example, Photo Vista software by Live Picture, Live Picture Reality Studio or Live Picture Object Modeler. Stitching may comprise sufficient photos for a 360 degree panoramic image of a scene. If images are stitched, they may be touched-up at step 60.

At step 62, if desired, and if the enhanced digital image file has not yet been compressed (e.g., by scanning device 18 or the touch-up software), the image is then converted from a bitmap file format (e.g., BMP) to a compressed file format (e.g., JPEG). Other compression algorithms are contemplated. Adobe Image Ready software is utilized to perform the BMP-to-JPEG file conversion in this exemplary embodiment. The compression is set to a very high compression factor, such as, 70% to 90%, but may alternatively be set to other compression factors. The target image area be set as one of the parameters for compression, thus ensuring an optimum compressed file size.

At step 64, user interface or control data is associated with the enhanced digital image file. The user interface data is a program or code segment (e.g., a Java applet) that provides a graphic user interface on display 30 upon loading of the image. The user interface program is associated with the enhanced digital image file such that the combined file or files can automatically launch the graphic user interface, decompress the digital image data, and display at least a portion of the digital image data within a viewing window having a predetermined viewing size on display 30.

The user interface data may alternatively be a plug-in, applet, or other software program, such as, Photo Vista, Reality Studio, or Object Modeler manufactured by Live Picture Inc., San Francisco, California, or an IPIX plug-in manufactured by Internet Pictures Corporation of Oak Ridge, Tennessee. The user interface data may be either associated with the enhanced digital image file such that it is downloaded with the enhanced digital image data, or it may be launched independently from the enhanced digital image data as, for example, an applet or plug-in on user computer 28. If the user interface data is launched independently of the image data, it may either be first opened by the user before downloading the enhanced digital image file, or it may be automatically opened by the enhanced digital image file, such as, via a script or other code segment within the enhanced digital image file.

Referring to FIG. 3, an exemplary screen print 80 from display 30 is shown illustrating the graphical user interface 82 generated by the user interface program. User interface 82 includes a viewing window or frame 84 for displaying the digital image data 86. User interface 82 further includes zoom buttons 88 for allowing the user to zoom into and out of digital image data 86. By actuating one of zoom buttons 88, user interface program resizes digital image data 86 within viewing frame 84. User interface 82 further includes panning buttons 90 to allow the user to pan up, down, left, and right within image data 86.

Once the user interface program is associated with the enhanced digital image data, the resulting image is ready for providing to a network server, projection from a projector, display system, posting, or playback, to or from a host computer, a Web server, a Web site, or a Web page. At step 66, the enhanced digital

image is uploaded to a network server. In the instance where the enhanced digital image is posted to an Internet Web server, the upload from computer 22 to the respective server can be performed by utilizing file uploading software, such as, Web FTP (file transfer protocol) Pro software, manufactured by Ipswitch, Inc., Lexington, Massachusetts.

Referring now to FIGS. 3, 4, and 5, exemplary print screens are shown illustrating the result of an upload or download of the enhanced digital image file to user computer 28 for display on display 30. In FIG. 3, digital image data 86 of a collectible stamp image is shown within a viewing window 84. Although viewing window 84 is slightly smaller than the full-screen size of display 30 (e.g., 640 x 480 pixels in this example), viewing window 84 can alternatively be configured for full-screen display, or display in other sizes or resolutions. As shown, digital image data 86 shows no sign of pixelation.

In FIG. 4, a user has actuated zoom buttons 88 to zoom-in to the digital image. In response, the user interface program provides additional digital image data from the enhanced digital image file stored in a memory (e.g., a hard drive) of user computer 28, to provide a zoomed view of the digital image. Thus, the view of FIG. 4 also shows little sign of pixelation even though the image has been magnified many times.

In FIG. 5, a user has actuated pan buttons 90 to display the lower left-hand corner of the digital image data within viewing window 84. The user has also actuated zoom buttons 88 to zoom-in to the digital image data. Again, little pixelation is visible.

As mentioned, the principles described herein are also operable with a digital image taken by a digital camera. Referring

now to FIG. 6, a method 100 of providing an enhanced digital image file utilizing a digital camera is shown. At step 102, the digital camera is configured to acquire a digital image. In this step, the camera is set with a high resolution to acquire at least enough pixels
 5 for a magnification of two times the size of the viewing window provided on display 30, though higher numbers of pixel data may also be acquired.

Again referring to FIG. 7 and the corresponding description hereinabove, with a digital source image, the maximum magnification
 10 factor (mmf) should not produce a target image larger than the source image in pixels because of the pixel distortion or pixelation effect, i.e., distortion due to fewer pixels in the image being displayed than available in the viewing window. Since:

$$\text{target image area (tia)} = \text{tiw} \times \text{tih} = \text{via} \times \text{mmf}$$

15 then to obtain the target image width and height:

$$\text{tiw} = \text{tia} \times \text{sir}$$

$$\text{tih} = \text{tiw} / \text{sir}$$

If $\text{tih} > \text{sih}$ then set $\text{tih} = \text{sih}$ and $\text{tiw} = \text{siw}$

EXAMPLE 4

20 Determine the Target Image size and dimensions, and minimum scan density for the following case:

Source Image = 1600 x 1200 pixels

Desired Magnification Factor = 20

Source Image Aspect Ratio = $1600 / 1200 = 1.33$

25 Define the Viewing Window: assume 480w x 360h pixels

Viewing Window Aspect Ratio = $480 / 360 = 1.33$

The Source Image Aspect Ratio is = the Viewing Window Aspect Ratio:

$$\overset{1.33}{0.75} = \overset{1.33}{0.75} \text{ therefore:}$$

$$\text{vih} = \text{vwh} = 360 \text{ pixels}$$

$$v_{iw} = v_{ih} * 1.33 = 360 * 1.33 = 480 \text{ pixels}$$

The Viewing Image area = $v_{ia} = 480 \times 360 = 172,800$ pixels

The Target Image area = $v_{ia} \times 20 = 172,800 \times 20 = 3,456,000$ pixels

The Target Image width = $\sqrt{3,456,000 * 1.33} = 2147$ pixels

5 The Target Image height = $2147 / 1.33 = 1610$ pixels

But t_{ih} of 1610 pixels is > 1200 pixels therefore:

$$t_{ih} = 1200 \text{ pixels}$$

$$t_{iw} = 1600 \text{ pixels}$$

$$t_{ia} = 1200 \times 1600 = 1,920,000 \text{ pixels}$$

10 Effective Maximum Magnification Factor = t_{ia} / v_{ia}
 $= 1,920,000 / 172,800 = 11.1$

The Minimum Scan Density = N/A

Steps 104 (touch-up image), 106 (compress file), 108
 (associate user interface data), and 110 (upload file) may proceed as
 15 described with reference to FIG. 2 in the print film image exemplary
 method.

The above method can be repeated using different
 depth images or digital photographs for the images in order to create
 areas of higher resolution or "hot spots" within an image for detailed
 20 close-up inspection or viewing. These depth images can be linked to
 the respective image or image segment. The above method can be
 utilized in order to create higher zoom capabilities with each new
 depth layer of an image.

The above method can be utilized for applications
 25 including single images, single panoramic images, stitched images,
 non-stitched images or any other suitable image type.

The system and method of the present invention can
 also be utilized in conjunction with three-dimensional images in order
 to produce high resolution, three-dimensional digital images and 3-D
 30 texturings.

The resulting images which are obtained via the exemplary system and method are characterized by a high definition resolution and are suitable for high definition television, Web television, and large, panoramic or object models, Internet applications, which preserve resolution upon image magnification or reduction. The exemplary embodiment also dispenses with the need for plug-in software during download or file transfer operations.

EXAMPLE 5

A variety of photographs were taken using several different types of cameras. A digital camera was used to take several digital images. A Hasselblad camera was used to take several print film images, some of which were 2 ¼" square and others of which were 4 x 5" square. The print film images were taken to a film developing center to be enlarged to 8 x 12" pictures.

The enlarged pictures were scanned with UMAX Astra scanner using Adobe Photo Editor. Some bitmap files were created and some JPEG files were created. In spite of conventional teaching to the contrary, the scanner was set for a high resolution: 600 dpi. For the JPEG files, compression was set to 30:1.

Some of the images were stitched together using Photo Vista. The stitched images were then compressed at a high ratio of compression to generate JPEG files. The compressed files were touched up using Adobe Photo Editor and then uploaded to an Internet server. The uploaded files were then downloaded from the Internet server. The download took only a short time. The images were observed to have exceptionally high quality.

In review, a method is disclosed of providing a digital image file for viewing in a viewing window of a user display, the

viewing window having a predetermined size. The method includes providing a digital image having an image size comprising a fixed number of pixels representative of an image, the image size being greater than the predetermined viewing window size. The digital
5 image file is associated with a user interface that is configured to display the digital image in the viewing window and to allow a user to zoom into and pan around in the image displayed in the viewing window while maintaining high image quality.

While the exemplary embodiments illustrated in the
10 FIGS. and described above are presently preferred, it should be understood that these embodiments are offered by way of example only. For example, the specific pixel counts and display sizes disclosed herein are merely exemplary and are used to illustrate the pertinent principles. Also, not all of the steps of the exemplary
15 embodiments need be performed in all embodiments, nor need they be performed in the specific order recited. Accordingly, the present invention is not limited to a particular embodiment, but extends to various modifications that nevertheless fall within the scope of the appended claims.

20

WHAT IS CLAIMED IS:

1 1. A method of providing a digital image file for viewing on
2 a user display in a viewing window having a predetermined size, the
3 method comprising:

4 providing a digital image file having an image size
5 comprising a fixed number of pixels representative of an image,
6 wherein the image size is greater than that of the predetermined
7 viewing window size.

8 2. The method of claim 1, further comprising providing a
9 user interface for the digital image file, the user interface configured
10 to display the digital image file in the viewing window and to allow a
11 user to zoom into the image displayed in the viewing window,

12 3. The method of claim 1, wherein the image size is at
13 least ten times that of the predetermined viewing window size.

1 4. The method of claim 1, wherein the user interface is
2 configured to allow the user to pan across the image.

1 5. The method of claim 1, wherein the user interface
2 prevents the user from zooming into the image to the point of
3 pixelation.

1 6. The method of claim 1, wherein the digital image file
2 includes the user interface in a single data file.

1 7. The method of claim 1, wherein the user interface is an
2 application program applet.

1 8. The method of claim 1, wherein the user interface is an
2 application program controlled by the user's computer.

1 9. The method of claim 1, further comprising compressing
2 the digital image file.

1 10. The method of claim 1, further comprising uploading
2 the digital image file to a network server.

1 11. The method of claim 1, wherein the digital image file is
2 generated from a print film image.

1 12. The method of claim 1, wherein the digital image file is
2 acquired with a digital camera.

1 13. The method of claim 1, wherein the predetermined size
2 represents a full-screen size of the user display.

1 14. A method of providing an enhanced digitized image file
2 to a user, comprising:
3 providing a viewing window size in which the digitized
4 image file is to be displayed to a user;
5 providing a digitized image file having an image size
6 greater than that of the predefined viewing window size;
7 compressing the digitized image file; and
8 providing the compressed image file to a network
9 server.

1 15. The method of claim 13, further comprising:
2 under user control, transmitting the compressed image
3 file over the network;
4 displaying the transmitted image file to the user in a
5 viewing window having the predefined viewing window size; and
6 under user control, magnifying the displayed image
7 within the viewing window.

1 16. The method of claim 14, further comprising, under user
2 control, moving the displayed image in the predefined viewing
3 window size.

1 17. The method of claim 14, further comprising providing
2 the user with a plurality of selectable magnification levels to view
3 the displayed image within the viewing window.

1 18. The method of claim 14, wherein the resolution of the
2 digitized image is greater than that of the image displayed to the
3 user in the predefined viewing window size without image
4 magnification.

1 19. The method of claim 16, wherein the selectable
2 magnification levels are limited such that no more than one pixel of
3 the user display can display one pixel of the digitized image.

1 20. The method of claim 13, wherein the digitized image
2 file is compressed to a JPEG format.

1 21. The method of claim 13, wherein the step of generating
2 includes enlarging and scanning a print film image to provide the
3 digitized image file.

1 22. The method of claim 19, wherein the print film image is
2 scanned with a density of at least 100 dots per inch.

1 23. The method of claim 13, wherein the step of generating
2 includes acquiring the digitized image file with a digital camera.

1 24. The method of claim 13, wherein the compressed
2 image file is accessible via the Internet.

1 25. The method of claim 14, wherein magnifying the
2 displayed image does not degrade the image quality.

1 26. An enhanced digital image file downloadable to a client
2 computer having a viewing window on a display, the viewing
3 window having a predetermined frame size, the digital image file
4 comprising:

5 digitized image data representative of an image,
6 wherein the digitized image data has a number of pixels sufficient to
7 allow a user to magnify the digitized image in the viewing window
8 by a magnification factor of at least two without pixelation; and
9 control data to allow the user to control the
10 magnification factor.

11 27. The enhanced digital image file of claim 25, wherein the
12 digitized image data is compressed.

1 28. The enhanced digital image file of claim 25, wherein the
2 control data is configured to provide zoom buttons and pan buttons
3 to a user.

1 29. The enhanced digital image file of claim 27, wherein the
2 control data includes a Java applet.

1 30. The enhanced digital image file of claim 25, wherein the
2 digitized image data has a number of pixels sufficient to allow a user
3 to magnify the digitized image in the viewing window by a
4 magnification factor of at least ten without pixelation.

1 31. The enhanced digital image file of claim 25, wherein the
2 digitized image data has a number of pixels sufficient to allow a user
3 to magnify the digitized image in the viewing window by a
4 magnification factor of at least one hundred without pixelation.

1 32. The enhanced digital image file of claim 25, wherein the
2 control data is configured to prevent the user from magnifying the
3 digitized image to the point of pixelation.

ABSTRACT OF THE DISCLOSURE

A method of providing a digital image file for viewing in a viewing window of a user display, the viewing window having a predetermined size. The method includes providing a digital image having an image size comprising a fixed number of pixels representative of an image, the image size being greater than the predetermined viewing window size. The digital image file is associated with a user interface that is configured to display the digital image in the viewing window and to allow a user to zoom into and pan around in the image displayed in the viewing window while maintaining high image quality.

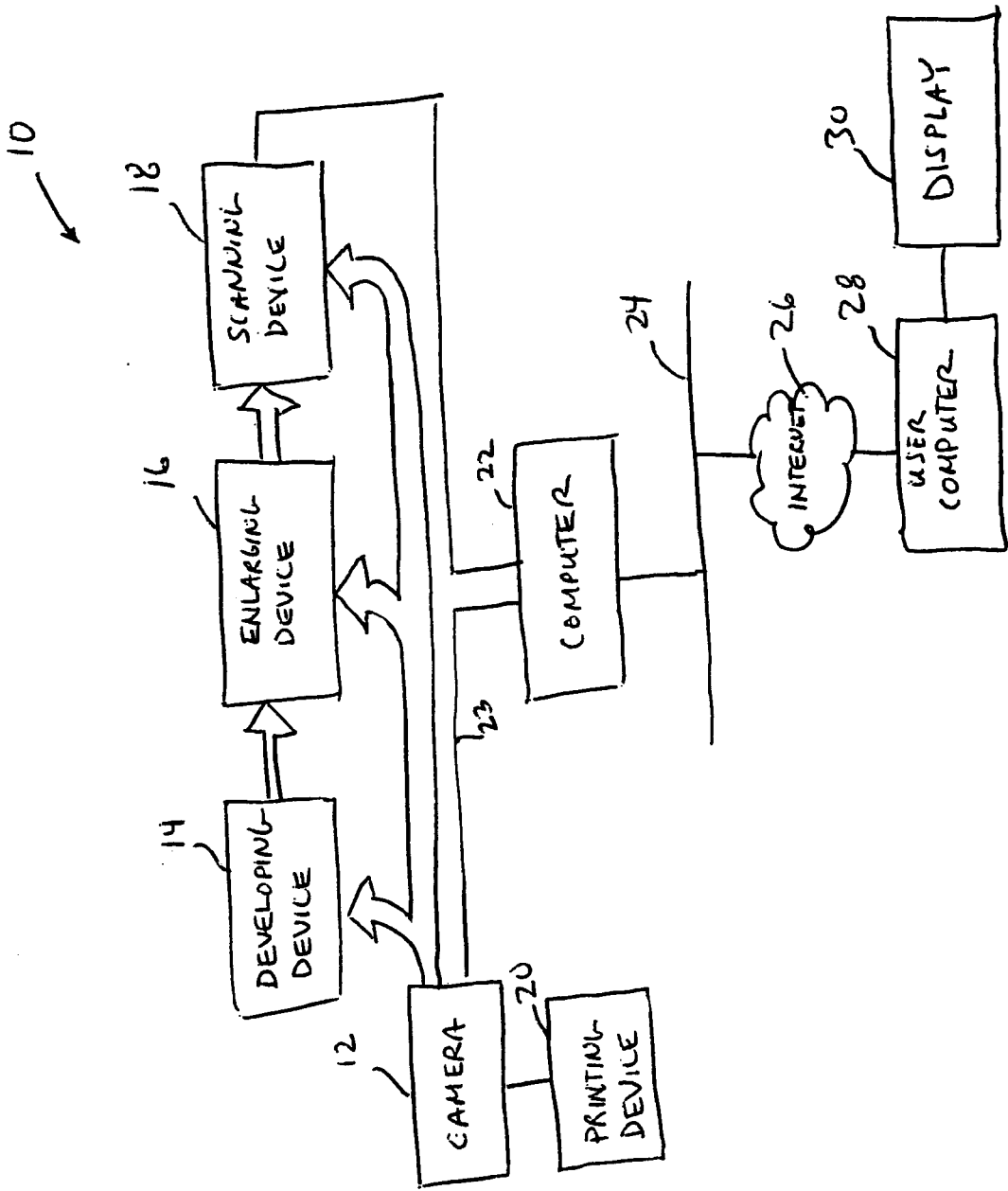

FIG. 1

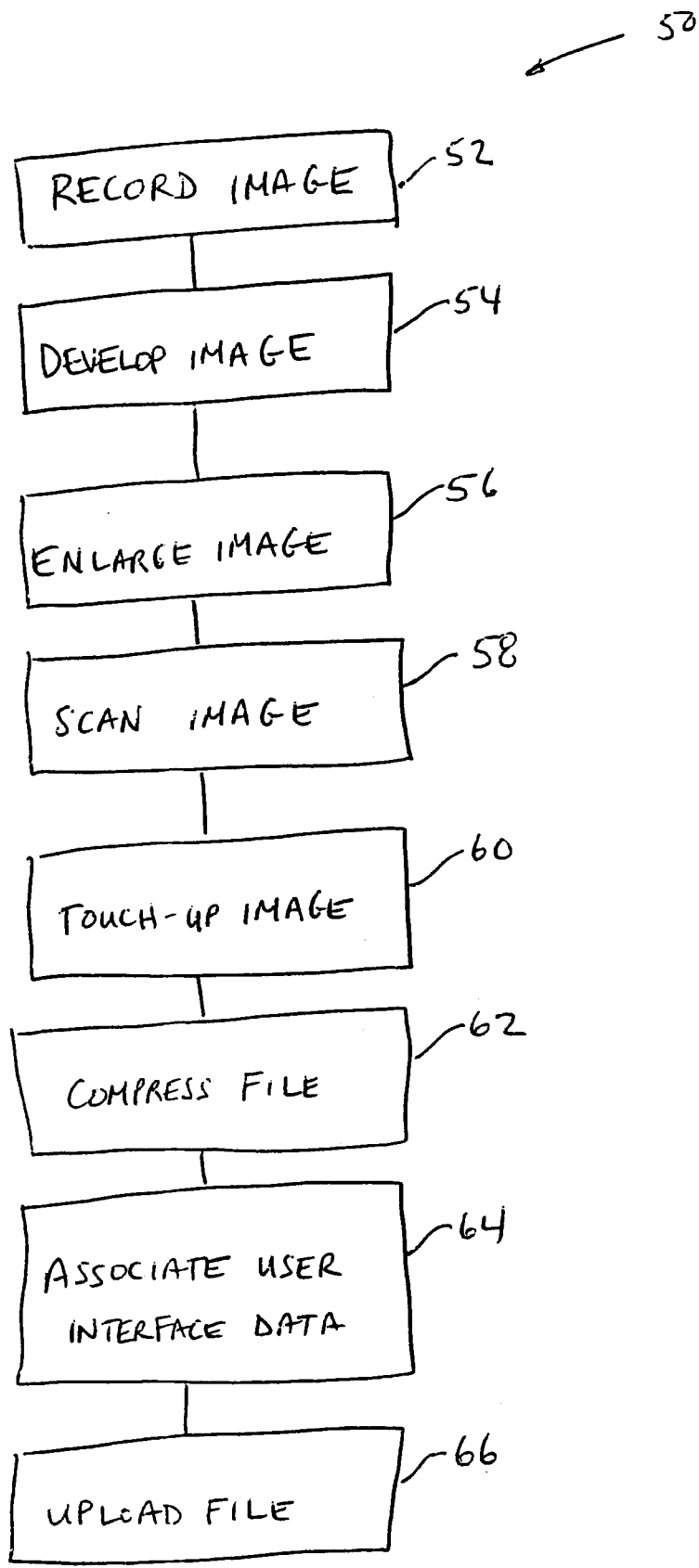
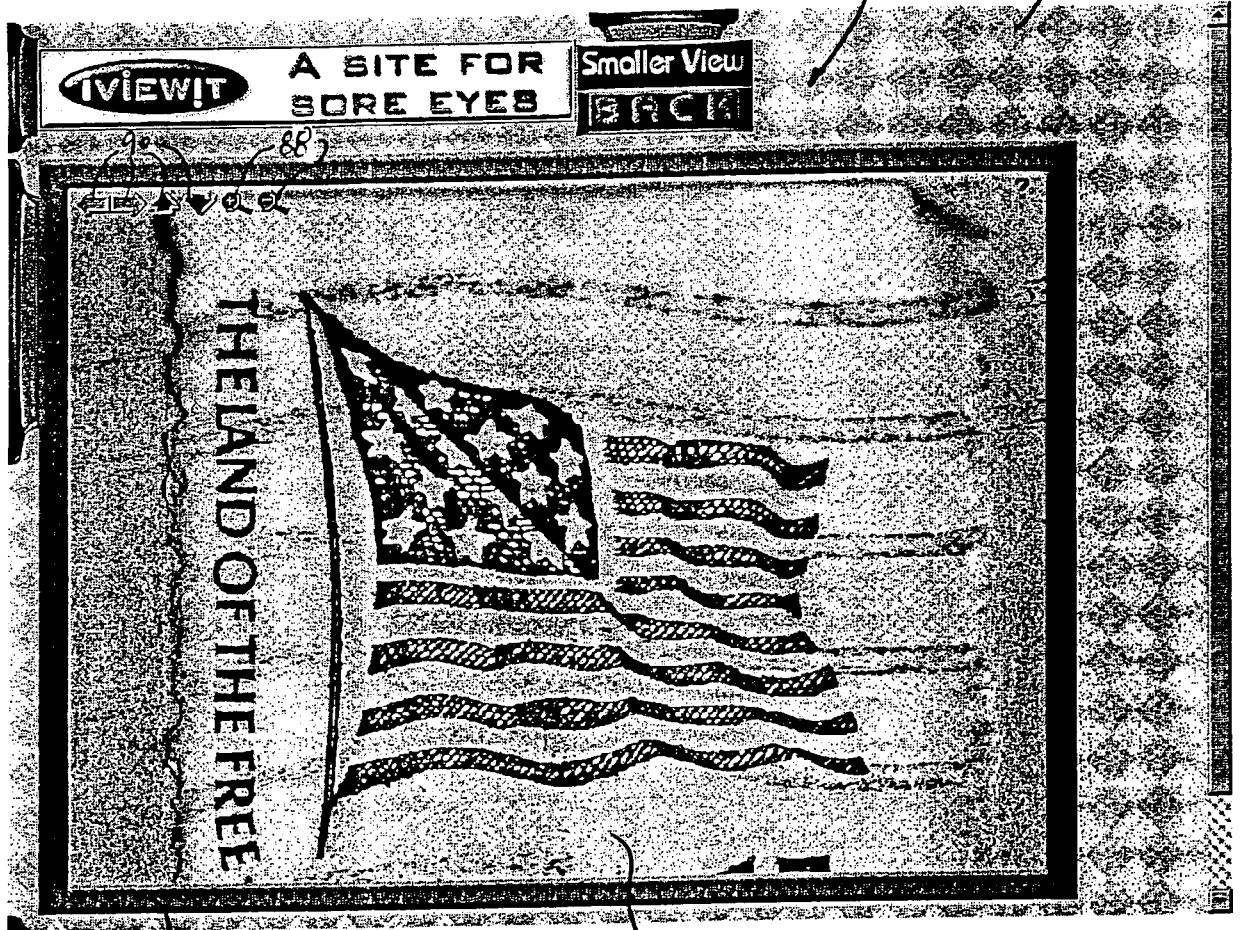

FIG. 2



VIEWIT

A SITE FOR SORE EYES

**Smaller View
EACIA**

THE LAND OF THE FREE

82

80

90

88

84

86

FIG. 3

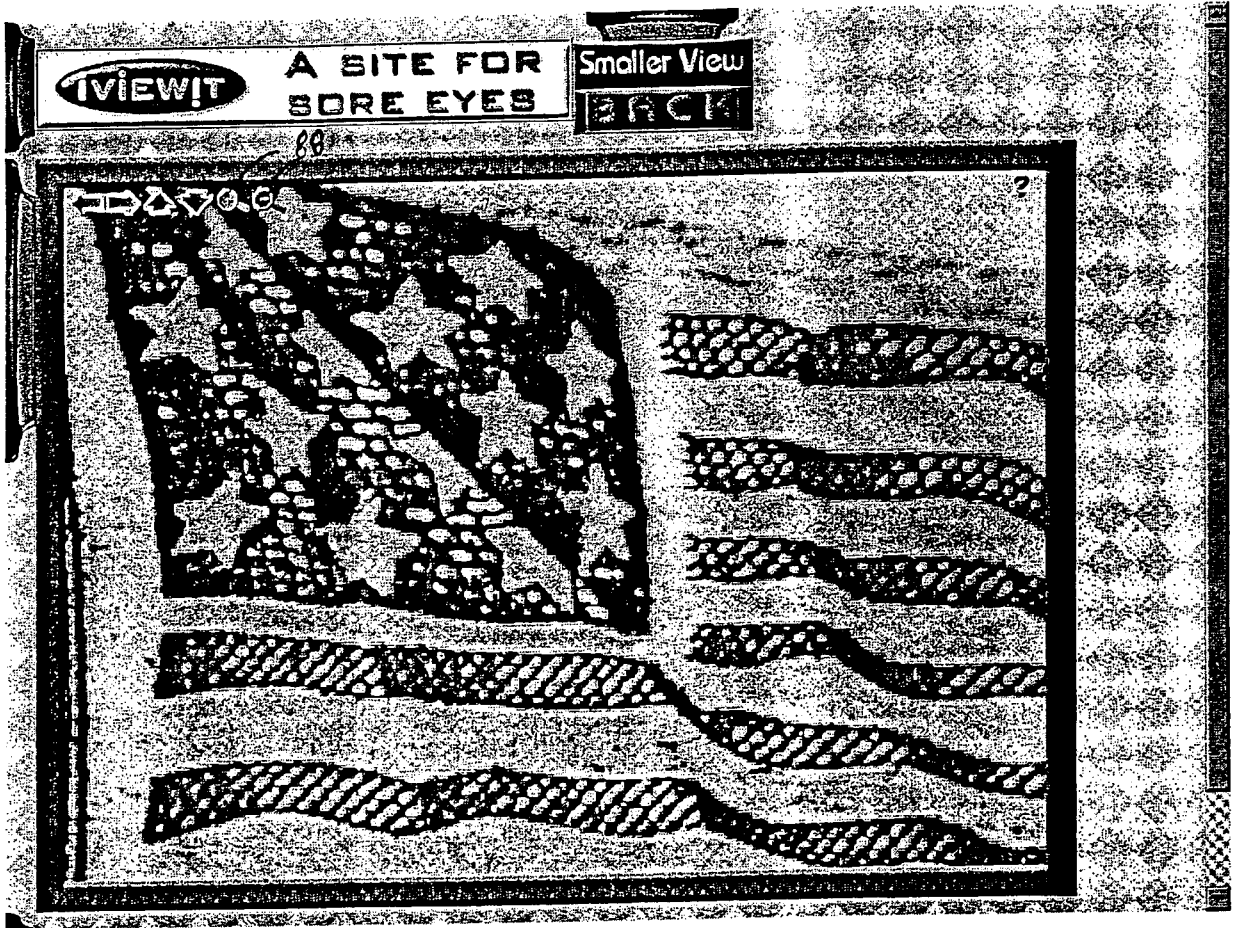

FIG. 4



FIG. 5

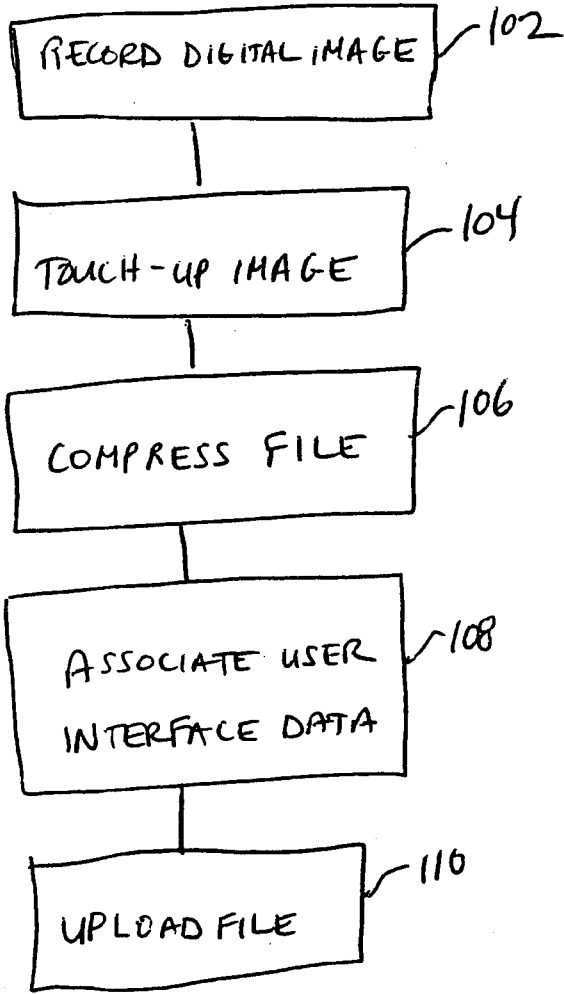

FIG. 6

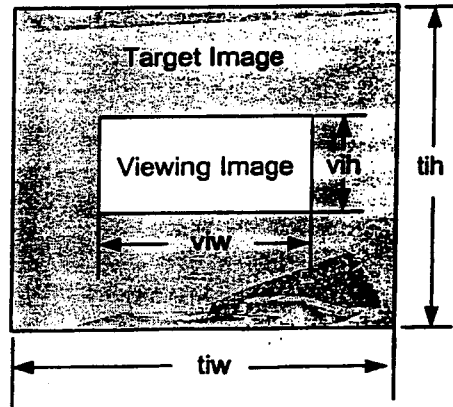
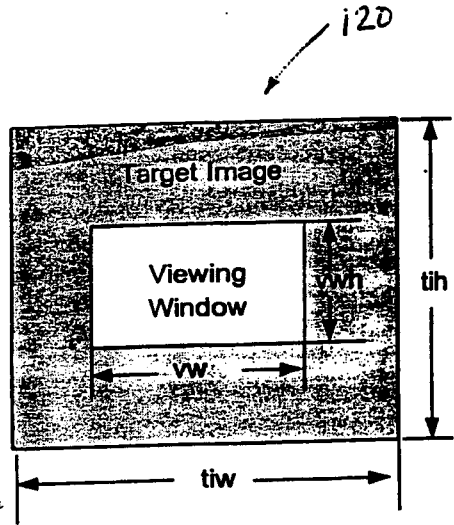
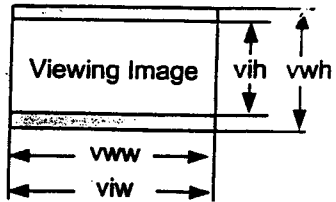
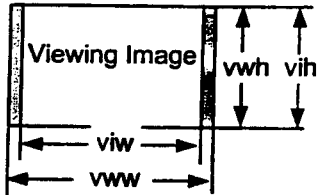
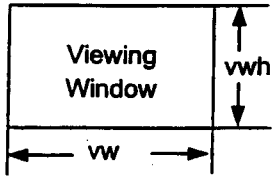
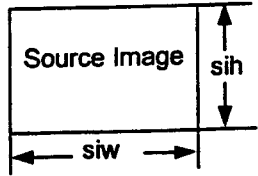

FIG. 7

COPY

U.S. PROVISIONAL PATENT APPLICATION

for

**ZOOM AND PAN IMAGING
USING A DIGITAL CAMERA**

Inventors:

Brian G. Utley
1930 SW 8th Street
Boca Raton, FLORIDA 33486
Citizenship: U.S.

Eliot I. Bernstein
500 S.E. Mizner Boulevard
Boca Raton, FLORIDA 33432
Citizenship: U.S.

FOLEY & LARDNER
Attorneys at Law
777 E. Wisconsin Avenue
Milwaukee, Wisconsin 53202
(414) 271-2400

**ZOOM AND PAN IMAGING
USING A DIGITAL CAMERA**

CROSS-REFERENCE TO RELATED APPLICATIONS

The present application is related to U.S. Patent Application No. 09/630,939, filed August 2, 2000, a copy of which is attached hereto and incorporated herein by reference.

5 **FIELD OF THE INVENTION**

The present invention is directed to a system and a method for producing enhanced digital images and, in particular, to a system and a method for producing enhanced digital images having improved resolution for zooming and/or panning within an image
10 downloaded from a digital camera to an external display system such as to a computer display or directly to a monitor.

BACKGROUND OF THE INVENTION

See attached information regarding digital cameras which is incorporated herein by reference.

15 See Background in related application.

DESCRIPTION OF THE INVENTION

The object of this invention is to enable a digital camera to provide pan and zoom capabilities to the digital pictures taken by the camera. The pictures may be viewed, either on the camera
20 through the viewing screen usually provided, or through a display attached to a computer which has received a file comprising the digital images taken by the digital camera, or through any other display system such as a television or monitor.

See attached Figure A1.

There are several embodiments:

In one embodiment, the software for viewing the images in pan and zoom mode is contained within the camera #1.

5 The photographer selects the image to be displayed on the viewing screen #2 and then selects the pan and zoom mode by use of control buttons which may be existing buttons multiplexed for this purpose. The necessary controls are: pan left, right, up, down, zoom in, zoom out. Including the pan and zoom facility in the
10 camera enables the close inspection of particular features of the image thereby ensuring that the image is meeting the objectives of the photographer.

In another embodiment, the digital file containing the images is transferred to the computer #10 through a cable
15 connection connecting the USB port #3 to USB port #11 or equivalent ports such as a serial port. Alternatively the digital file may be transferred by means of a media device such as a floppy disc or flash card. In this latter case, the file is written onto the media device using data media port #4 and read into the computer using
20 data media port #12. The computer #10 should have already been loaded with user interface software which provides the controls for displaying the digital images on computer display #20 and also for providing the pan and zoom feature controls.

An alternative embodiment is to include into the digital
25 file transferred from the camera #1 to the computer #10 the user interface software necessary to control the display and zoom and pan of the digital images in the computer. In this way no software is necessary to be pre-loaded into the computer #10.

Another alternative embodiment is to pre-load some software into computer #10 and load the remainder from the camera #1 through the digital file containing the images being transferred.

Note that the relationship between the target image and the viewing image is very important, as described in the related application. By panning the viewing window, every portion of the target image may be viewed from each level of zooming. Zoom capability is provided up to a maximum level where the image begins to pixelate.

In the related application, user interface or control data is associated with the enhanced digital image file. The user interface data is a program or code segment (e.g., a Java applet) that provides a graphic user interface on the display upon loading of the image.

In one embodiment of the present invention, the user interface program is associated with the digital image file in the camera and downloaded with the file or files so the computer or other display system can automatically launch the graphic user interface, decompress the digital image data if necessary, and display at least a portion of the digital image data within a viewing window having a predetermined viewing size. The user interface program can be written in C+ or C++ or other common languages. The user interface data may alternatively be a plug-in, applet, or other software program.

The user interface data may be either associated with the enhanced digital image file such that it is downloaded with the enhanced digital image data, or it may be launched independently from the enhanced digital image data as, for example, an applet or plug-in on computer #10. If the user interface data is launched independently of the image data, it may either be first opened by the

user before downloading the enhanced digital image file, or it may be automatically opened by the enhanced digital image file, such as, via a script or other code segment within the enhanced digital image file.

5 The user interface includes a viewing window or frame for displaying the digital image data, and further includes zoom and pan functions as described in the related application.

Note that the amount of zoom capability provided by the user interface will vary depending upon the display size and resolution. Nevertheless, the zoom capability should reach a
10 maximum when the image begins to pixelate as defined in the related application.

For example, if the original image is 1500 (width) x 1200 (height) pixels, and the camera viewfinder display has a 256 x 180 screen size, then the image can be magnified to 39 times,
15 whereas the same image can only be magnified to 3.75 times in an 800 x 600 computer monitor. In either case, at the maximum zoom, the zoomed portion of the original image will be fully detailed pixel-for-pixel.

If the digital image file, including the user interface
20 program, is provided directly to a television or monitor that does not have zoom or pan controls or buttons, the controls or buttons on the camera will be used.

As mentioned in the related application, the digital camera is typically set with a high resolution to acquire at least
25 enough pixels for a magnification of two times the size of the viewing window provided on the display, though higher numbers of pixel data may also be acquired. The same or related mathematical formulas for determining the maximum magnification factor (mmf) in the related application apply in the preferred embodiment.

Note in the preferred embodiment that the display is viewing all or a portion of the entire image that was downloaded to the computer #10, and not downloading portions "on the fly" as they are needed.

5 In the preferred embodiment, the image can be panned while zoomed in to the maximum.

PAN AND ZOOM IMAGING USING A DIGITAL CAMERA

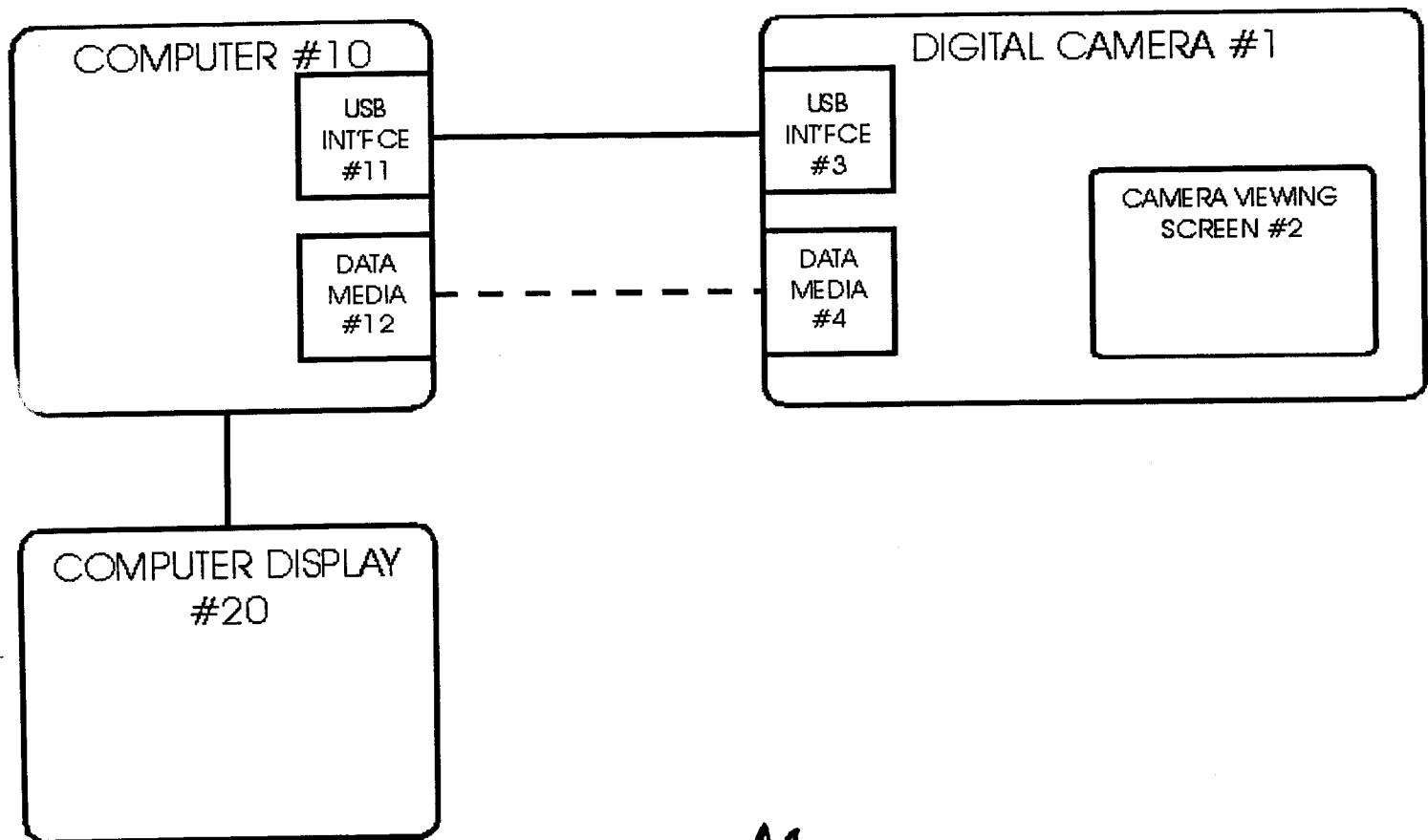

FIGURE A1



This page has been formatted to facilitate printout of the review.

Use your browser's "Back" button to return to the previous page, or the links at the top and bottom of this page to navigate to related information. If you have difficulty fitting the text on this page onto your printer output, simply resize your browser window to a narrower width and print again.



[Back to Full Olympus C-3030 Review](#)
[Go to Olympus C-3030 Data Sheet](#)
[Go to Olympus C-3030 Pictures Page](#)
[Up to Imaging Resource Cameras Page](#)



Olympus C-3030

Olympus extends their popular high-end compact to 3.3 megapixels, adds sound to its movies!

(Review first posted 5/10/2000)

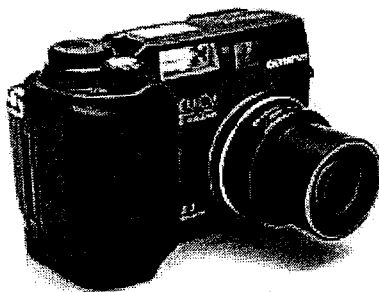

- *3.14 megapixel resolution (3.34 megapixel CCD) for 2048 x 1536 images
- *Multiple exposure modes, including full manual
- *Total of 5 resolution modes, with uncompressed TIFF format available in all
- *Optional manual focus with distance readout on LCD screen
- *Sync connection for external flash unit
- *Movie recording with sound, up to 300 seconds in SQ (160x120) mode

Manufacturer Overview

With one of the broadest digicam lineups in the industry, Olympus is a traditional camera manufacturer who's successfully making the transition to the digital era. A little over a year ago (this is being written in May, 2000) they introduced one of the first 2 megapixel digicams on the market, the C-2000 Zoom. It proved to be extremely popular, offering a compelling combination of features and excellent picture quality. They subsequently upgrade it with the C-2020 Zoom, a model offering improved functionality and user interface design. Now, they've extended the same basic (and successful) design to the three megapixel arena, with the C-3030 Zoom. The new model is again evolutionary, rather than revolutionary, but once again, Olympus appears to have listened to customer input and incorporated many of the most-requested features. Overall, the new camera is a very strong entry in the three megapixel arena, and should compete well in that market.

Highlights

- 3.34 megapixel (3.14 effective), 1/2 inch CCD delivering up to 2048 x 1536 pixel images.
- 1.8 inch, TFT color LCD display.

- 3x, 6.5 to 19.5mm lens (equivalent to a 32 to 96mm lens on a 35mm camera) with auto and manual focus.
- 2.5x digital telephoto.
- Apertures from F/2.8 to F/11.
- Shutter speed from 1 to 1/800 seconds in Auto exposure mode (16 to 1/800 in Manual).
- Variable ISO settings of Auto, 100, 200 or 400.
- Exposure compensation from -2 to +2 in 1/3 EV increments.
- Adjustable white balance with Auto, Clear, Cloudy, Tungsten and Fluorescent settings.
- Digital ESP (matrix) and Spot metering options.
- Program AE, Aperture Priority, Shutter Priority and Manual exposure modes.
- Movie recording mode with sound and shutter speeds from 1/30 to 1/10,000 seconds.
- Continuous Shooting, Auto-Bracketing, Black & White, Sepia and other special exposure modes.
- Built-in flash with Auto, Red-Eye Reduction, Fill-In, Off and Slow-Sync modes.
- External flash PC sync.
- 12 second self-timer with remote control.
- JPEG, uncompressed TIFF, Wave and QuickTime Motion JPEG file formats.
- Image capture on SmartMedia.
- USB and serial computer connections.
- Direct print capabilities with optional Olympus printer.

Executive Overview

A few months ago (early 2000), Olympus introduced the C2020 as a welcome upgrade to their previous C-2000 Zoom digicam: Olympus obviously listened closely to users, and implemented many of the most-requested features in the new model. Now, they've taken the same basic (successful) design and created the C-3030, giving it a larger, 3.3 megapixel CCD, sound recording capabilities and several other feature additions and user-interface improvements. The net result is very pleasing, certain to appeal to fans of the former models, or to anyone looking for a high-performance "prosumer" digicam. Design-wise, the C-3030 looks much like its predecessor, with the exception of its monotone black body (the C-2020 featured a silver and black design). The C-3030 retains the lightweight portability of its predecessor, easily slipping into a large coat pocket or purse. The only design complaint we have is the lens cap, which doesn't tether to anything and can be easily lost. It's a minor issue, but one we're compelled to harp on just the same: We've lost too many lens caps in our lives, and a tether strap is just too easy to add for manufacturers to have an excuse not to. On the plus side, we were glad to see that Olympus redesigned the previously awkward battery compartment cover. Now, you just slide a lock and then slide the cover open, without needing superhuman hand strength or more fingers than nature gave us.

The C-3030 offers a 3x, 6.5 to 19.5mm lens (equivalent to a 32 to 96mm lens on a 35mm camera) with both auto and manual focus options. This looks like it's physically the same lens as on the C-2020 Zoom, with the difference in focal length resulting from the slightly larger physical dimensions of the CCD. We were very happy to see the continuance of the distance scale that appears on the LCD when using manual focus, as it greatly helps in hard to focus situations. There's now also a handy focus-assist feature, whereby the LCD display zooms to a larger scale whenever you actuate the manual focus adjustment. Apart from the temporary "zoom" while focusing, the 2.5x digital telephoto is activated through the Record menu, preventing you from accidentally sliding into the digital zoom range, a feature we like to see. The C-3030 sports both optical and LCD viewfinders for composing images. As with its

predecessors, power consumption is exceptionally low when the LCD is off, meaning you can leave the camera on all day without worrying about draining your batteries.

Exposure-wise, we appreciate the degree of control the C-3030 provides. Although many of the camera's settings rely on the LCD menu system, you can still set the flash, macro and metering options without resorting to the LCD. Unfortunately, changing the exposure compensation or altering other exposure settings requires accessing the LCD menu system. (In general, we prefer to see digicams that permit significant control via the top-panel data readout, rather than the LCD panel. This really helps to conserve battery power!) However, in Playback mode, functions like Delete, Write Protect and Print can now be controlled by pressing a single button (previously requiring use of the menu system). You get as much or as little exposure control as you want with the C-3030, via Program AE, Aperture Priority, Shutter Priority and Manual exposure modes. In all modes except for manual, you have an aperture range from F/2.8 to F/11 and shutter speeds from one to 1/800 seconds. In Manual mode, the shutter speed range extends to 16 to 1/800 seconds, giving you much longer exposure times. We liked the fact that, in all modes except Program AE, the camera indicates whether an exposure is going to be too dark or too light, giving you a chance to alter the exposure settings before snapping the picture. We also really like the on-screen display of the aperture and shutter speeds the camera has chosen.

White balance and exposure compensation offer the traditional settings and you have a choice between Spot and Digital ESP (matrix) exposure metering. Thus far, Olympus digicams haven't offered a "manual" white balance mode, and the C-3030 doesn't either. We really like to see manual white-balance options (also called "preset" or "one-push" white balance by some manufacturers), especially on cameras as advanced as the C-3030 Zoom. The built-in flash provides the standard Auto, Red-Eye Reduction, Fill-In and Off modes, but can be also combined with slow shutter speeds to achieve various low light exposures through the Slow-Sync setting. In slow sync mode, the flash may be synchronized with either the opening or closing of the shutter. There's also a sync socket for an external flash, which can be used either with or without the built-in flash. You can control flash exposure independently of that for ambient light, via the flash intensity setting, which is adjustable from -2 to +2 in 1/3 EV increments. Combine this with the variable ISO option (100, 200 or 400) and you get an excellent range of exposure control options, especially in low-light situations.

The Sequence, Auto Bracketing and Panorama shooting modes provide a nice range of exposure options and cater to a number of shooting situations. We also like the Picture Effects menu, which offers Black and White, Sepia, White Board or Black Board shooting modes, helpful in a variety of scenarios. A nice bonus on the C-3030 is the ability to record sound, both with movies and still images. This makes movies a little more interesting and can be really helpful in labeling still images. (The lack of sound recording in its movies was a frequent complaint we heard from owners of the earlier C-2020.) Do note though, that the C-3030 Zoom has no internal speaker, so you'll have to download your movies to a computer to hear the audio track.

The C-3030 offers a range of image resolution sizes, from 2048 x 1536 to 640 x 480 (five sizes in all) with a variety of quality settings. Files are saved as JPEGs with an option for uncompressed TIFF at all image sizes. Images are stored on SmartMedia cards and an 16mb card is packaged with the camera. The C-3030 supports both USB and the standard serial interface, accommodating both PC and Mac users. Additionally, an NTSC video cable means that you can play back movies and captured images on your television set, or even use the TV as an expanded LCD monitor for image composition. (European models come equipped for the PAL video standard.)

Overall, the C-3030 Zoom is a very worthy extension to the previous C-2020 Zoom: Combining lightweight portability, a 3.3 megapixel CCD, wide array of resolution choices, and excellent exposure controls, it's flexible, user-friendly, and high performance. We own a C-2020 Zoom and use it for all our product shots that appear on the web site: We have to confess to being sorely tempted by the new 3 megapixel C-3030 Zoom, even though our C-2020 is less than six months old. (This is an occupational hazard in the digicam world, where there's **always** something coming out better than the product you acquired just months before...) Whether you're entering the market for the first time, or upgrading from an earlier model though, the C-3030 Zoom presents a wealth of features and capabilities, and excellent

image quality in the bargain.

Design

With the C-3030 Zoom, Olympus has kept the familiar lightweight, compact styling of earlier models in the line, but this time with an all black facade. In fact, it incorporates all the features of the C-2020 Zoom, but now with a 3.3 megapixel CCD and sound recording capability (not to mention a wider array of image resolution sizes). The very rugged plastic body gives the camera a low weight of 10.6 ounces (300.5g). Dimension-wise, the camera measures 4.3 x 3.0 x 2.6 inches (107.5 x 76.4 x 66.4mm), so it's easily stashed in a coat pocket or purse. Overall, the design is almost identical to the C-2020 Zoom, with the sole exceptions of a larger handgrip area and a much easier to operate battery compartment lid.



Aside from the monotone body, the C-3030 doesn't look too different from the previous C-2020. The front of the camera is relatively clean, featuring the telescoping lens, built-in flash, optical viewfinder front and the remote control infrared sensor. When fully retracted, the lens only adds about a quarter of an inch protrusion beyond the handgrip to the front of the camera. When the camera is turned on, the lens comes out of hiding and likewise retracts when the camera is switched off. A minor gripe here is that the lens is protected by a removable lens cap that doesn't have a tether or any place to attach one. While this isn't a big deal, lens caps have a habit of disappearing, so we like to see designs that either omit them, or provide some sort of tether.

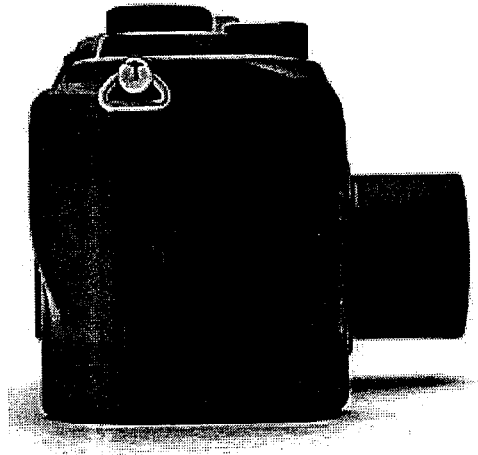

We're glad to see the continuance of the hefty handgrip on the side of the camera which holds the SmartMedia slot (beneath a snug plastic cover that snaps tightly into place). As noted above, the handgrip on the C-3030 Zoom is a little larger than that on the earlier 2020, making for a bit more secure grip.

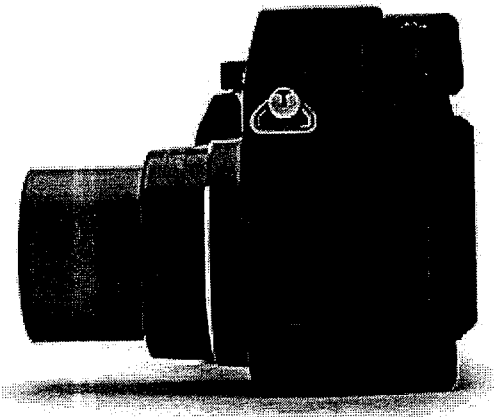

On the opposite side of the camera are the digital, AC and video input jacks, also protected by a snug plastic cover. The dioptic adjustment dial for the optical viewfinder and the external flash sync connector (notably, not a standard "PC" sync connector) are also on this side of the camera. Users will want to be careful with the flash sync cover, as it's tiny and can be easily lost.



Up top is a small information display panel, the mode dial, shutter release button and zoom control. The small information display reports many of the camera's exposure settings, but you still need to rely on the LCD for exposure compensation adjustments, aperture, and shutter settings. (Note to Olympus: Black & White readouts are cheap, both in terms of materials cost and battery power: We'd really like to see you make more use of them for routine operating controls!)

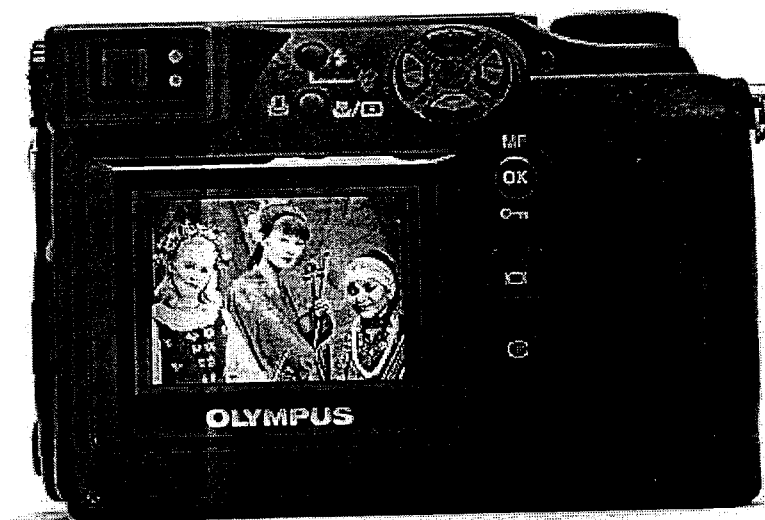

Most of the controls are on the back panel of the camera with the LCD monitor in the center. The flash and macro controls, arrow keys, manual focus, display and menu buttons live back here. There's also a small, red LED on the side closest to the SmartMedia slot that lets you know when the card is in use (and therefore not to open the slot).



Both the locking battery compartment and plastic tripod mount are located on the bottom of the camera. Unfortunately, they are too close to each other to allow quick battery changes when the camera is mounted on a tripod. Frankly though, we don't know how Olympus could have gotten around that problem on this model, as the bottom of the camera body isn't wide enough to allow any leeway in this area and at the same time keep the tripod mount centrally located. We are glad to report that the battery compartment is now **much** easier to open than the previous design, as you just slide the lock and push the compartment door outwards as it flips open. (The previous model really required both hands to get it open without dropping the camera). A minor quibble on this part of the camera: The C-3030 Zoom uses a plastic tripod socket, albeit a replaceable one. Metal tripod sockets are the exception rather than the rule, but we really like the added durability that metal provides. Accordingly, we try to mention the tripod socket material in our reviews, as an encouragement to digicam makers to use metal more frequently.

We're also glad to see the return of the small infrared remote control which lets you trip the shutter, operate the zoom lens and scroll through recorded images in Playback mode. We really enjoyed this feature and the amount of freedom it gives. (We make continual use of the IR remote on our C-2020 Zoom in all our studio shooting: It's incredibly handy!)

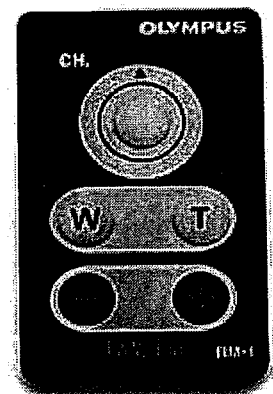

The tiny IR remote provides an amazing level of control without a "tether" connection.

Viewfinder

The C-3030 features both a "real image" optical viewfinder and an LCD monitor for image composition. The optical viewfinder has central autofocus crosshairs to help you line up shots and two small external LEDs that report whether or not the focus and/or flash is ready. There's also a small dioptic adjustment dial on the left side of the optical viewfinder, to assist eyeglass wearers, but the eyepoint is a bit lower than we'd like to see for use with glasses. The viewfinder zooms along with the lens, but

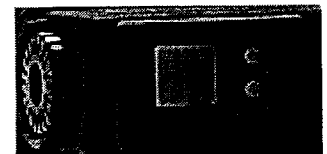

naturally doesn't respond to the 2.5x digital telephoto, which is dependent on the LCD monitor.

A 1.8 inch, TFT, color LCD monitor provides detailed feedback about the current exposure settings, showing the currently selected f-stop, shutter speed and exposure compensation in a row of numbers across the top. In Aperture and Shutter Priority modes, the aperture or shutter value appears continuously, along with the exposure compensation setting, while the second, automatically determined exposure value (either shutter speed or f-stop) appears whenever the shutter button is half pressed, triggering the autofocus and autoexposure systems. The same goes for Manual mode, except both values are displayed together. When the LCD monitor is turned on in record mode, some of the camera's exposure settings are listed as well, such as flash, exposure, etc.

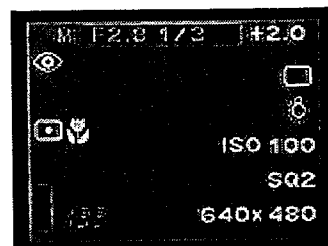

When using the LCD monitor to review captured images, you can actually zoom in on displayed images up to 3x, as shown in the screen shot at right. This is very handy for checking focus, small details or precise framing. When you're zoomed in, the jog dial buttons let you scroll around within the larger image. There's also the index display option, which displays either four, nine or 16 images at a time.

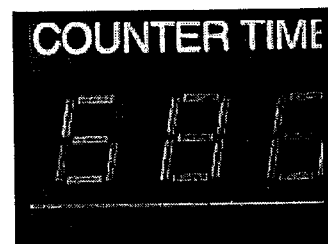

We found the C-3030's optical viewfinder to be a little tight, showing approximately 82 percent frame coverage at wide angle and about 81 percent at telephoto. (Note that we've changed our nomenclature on this to better reflect what you see looking into the viewfinder: We previously would have referred to the C-3030's viewfinder as "loose"...) These numbers are from the 2048 x 1536 resolution size but the smaller 640 x 480 resolution size numbers are similar at 83 percent accuracy for both wide angle and telephoto. We also noticed that the framing here slants just a little to the left vertically, possibly the CCD on our test unit was shifted a little. The LCD monitor proved to be much more accurate, showing about 97 percent frame coverage at wide angle and slightly over 100 percent at the telephoto setting. (The covered area at the telephoto end is just barely inside the darker lines we use to frame the viewfinder accuracy target). As with the optical viewfinder, the smaller, 640 x 480 image sizes weren't too far off from the larger ones (about 96 percent coverage at wide angle and just over 100 percent accuracy at telephoto). We generally like to see the LCD monitor as close to 100 percent accuracy as possible, so the C-3030 does a very good job in that respect. We also shot at the 2x digital telephoto setting (our studio isn't long enough to accommodate the full 2.5x), which probably would have produced close to 100 percent accuracy if framed properly. One problem with the digital telephoto is that framing is difficult because of the softer, slightly distorted image on the LCD. Additionally, the resulting image is somewhat soft, which is a usual side effect of the digital zoom.

Optics

The C-3030 Zoom comes with a 3x, 6.5 to 19.5mm, all glass aspheric lens (equivalent to a 32 to 96mm lens on a 35mm camera) with eight elements in six groups. This appears to be physically the same lens as in the C-2020 Zoom, with the wider-angle coverage being due to the larger size of the 3030's CCD sensor. Further evidence of the tight fit between lens and CCD is the set of small notches cut into the bezel around the lens' front element, to avoid vignetting in the corners of the final images. Despite the cutouts in the lens bezel though, we did notice a slight vignetting (darkness in the corners of the images) when the lens was set to its widest angle. This disappeared fairly quickly as we zoomed toward telephoto settings, but was noticeable in shots of flat-tinted subjects at full wide angle zoom settings. (We confess to being puzzled though, by the smaller f/2.8 maximum aperture of the 3030's lens, compared to the f/2.0 of the 2020.) Apertures can be manually adjusted in both Manual and Aperture Priority mode from F/2.8 to F/11, in 1/3 f-stop increments. The contrast-detect TTL autofocus system covers a range from 31 inches (0.8 m) to infinity in normal mode and from eight to 31 inches (0.2 to 0.8 m) in macro. The green LED next to the optical viewfinder lights solid when the autofocus system achieves a lock on the subject. Low light focusing performance is fairly good, with the camera able to achieve focus down to about 1 footcandle (11 lux, or about the brightness level of a well-lit nighttime

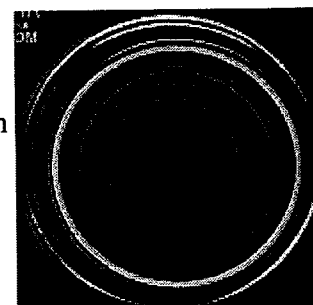

street scene). Below that level, you'll need to resort to manual focusing.

A manual focus option is available by simply pressing the MF button on the back panel which displays a small distance readout to help you gauge distance (in meters or feet). The screen shot at right shows the focusing scale in manual focus mode. The up and down arrow buttons adjust the focus along the scale and pressing the MF (or OK) button again cancels the mode. We liked the fact that the distance scale displayed is split into two segments, one ranging from 2.6 feet to infinity, the other from 8 to 31 inches. This provides the necessary resolution to focus accurately, without forcing you to squint and guess at single scale ranging from 8 inches to infinity. One nice feature of the 3030's manual focus operation is that the LCD viewfinder display enlarges by about 2x whenever the manual focus setting is changed. This is very helpful in deciding whether you've achieved good focus or not. (Although it's still difficult to judge critical focus from an LCD panel.) Here's a trick though, for further improving your focus accuracy using the LCD screen: Activate the digital zoom function, to get an additional 2.5x magnification of the subject. Once you're focused, you can back the lens off to frame the picture accordingly. (Actually, we're not certain that the C-3030 Zoom's lens doesn't change focus as you zoom it, but this technique seemed to work fairly well for us.)

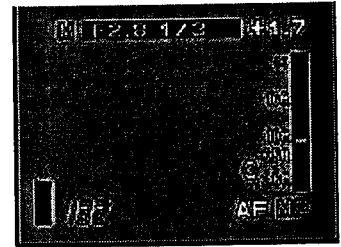

As with other Olympus cameras in this series (the C-2000 Zoom and C-2020 Zoom), the C-3030 Zoom has body-mounted threads that accept an accessory lens adapter, the CLA-1. This adapter is a small cylinder that gives you a set of 43mm filter threads just flush with the furthest forward extent of the lens when it telescopes out. NOTE though, that we said "just flush" - If you by chance were able to obtain an accessory lens or filter with 43mm threads on it, it wouldn't fit: You need a millimeter or so ahead of the adapter before the glass starts. This usually isn't a problem, since you'd almost always have a thread adapter tacked on the front of the CLA-1 anyway, the 43mm being such an odd size. Still, you can find 43mm accessories out there, so we thought we should at least mention this...

While the C-3030's lens provides up to 3x optical zoom, an additional 2.5x digital zoom can be activated through the Record menu, albeit with noticeable quality degradation in the resulting images at the larger image sizes. (The "digital zoom" options on all digicams simply crop into the CCD array to reduce the angle of view. They thus directly trade resolution for "magnification.") Note that the digital zoom cannot be used with the uncompressed TIFF mode and is only accessible with the LCD monitor on.

With a measured visual resolution of 850-900 lines per picture height in our resolution tests, the C-3030 Zoom is just a hair off the highest we've seen to date (May, 2000). Olympus deserves credit though, for not trying for a snappier-looking picture by over-sharpening the image in the camera. Our philosophy on image sharpening is that the capture device (camera, scanner, whatever) should do the bare minimum, compensating only for the blurring tendencies of its sensor. Once an image has been over-sharpened, detail is irrevocably lost and objectionable artifacts appear. To our eye, the C-3030 Zoom gets it about right, applying some sharpening, but not too much. Even at that, it offers a "soft" image-sharpening option that provides images without any in-camera sharpening, for those times when you need to perform critical manipulations on the image in Photoshop(tm) or other editing program post-capture.

The lens appears to be of good albeit not unusual quality, turning in fairly typical distortion and aberration numbers for lenses at the higher end of the consumer digicam spectrum: Geometric distortion on the C-3030 was moderate at the wide angle end, as we measured a 0.76 percent barrel distortion. The telephoto end showed a smaller, 0.29 percent pincushion distortion. Both numbers are about typical among digicams we've tested, but we do prefer to see lower distortion at the wide angle end. (Just to be clear, roughly 0.8 percent is pretty typical among digicams we've tested, we'd just like to see *all* digicams have lower barrel distortion.) Do note though, that there's an excellent, easy solution to barrel or pincushion distortion available, in the form of the optional "dewarp" plugin for our favorite image tweaker, PhotoGenetics. Read our [review of PhotoGenetics](#) for more details. Chromatic aberration was fairly pronounced at wide angle settings, with several pixels of color showing at the edges of elements in the corners of our resolution test target. At the telephoto end of the lens' range though, chromatic

aberration was essentially invisible. (This distortion is visible as a very slight colored fringe around objects at the edges of the field of view on the resolution target). The chromatic aberration was more severe at the wide angle end than the average for cameras we've tested, while it was much better than average at the telephoto end. We also noticed some slight vignetting of the image in the very corners, at the widest-angle lens setting. This last disappeared pretty quickly though, as we moved the lens out of the wide angle position.

Exposure

Exposure control is similar to the setup of the C-2020 Zoom, with an LCD menu system that controls most of the camera's settings. Four exposure modes are accessible through the mode dial: Program AE, Aperture Priority, Shutter Priority and Manual. Shutter speeds in all modes except Manual range from one to 1/800 seconds. The range broadens under the Manual setting to 16 to 1/800 seconds. A useful added feature relative to the previous model is that as you scroll through the various aperture/shutter settings in manual mode, the camera's exposure system remains "live". The camera tells you how it judges the exposure setting you've chosen, showing not only whether it thinks you're high or low, but by how much. It does this by displaying what it believes the over- or under-exposure to be using the digits on the LCD screen that normally indicate exposure compensation in automatic exposure modes. If you're more than plus or minus 3 EV units away from the correct exposure, the digits light up red, showing just +/- 3EV. This is really very helpful as it gives you a good idea of what the exposure will be like before snapping the shutter. (Other manufacturers take note: This is a nice feature, and shouldn't be too hard to add, if a camera already has a manual exposure mode.)

Exposure compensation is adjustable in 1/3 EV increments from -2 to +2, in all exposure modes except for Manual, by pressing the right and left arrow buttons. Additionally, the auto exposure bracketing function ensures you'll get a correct exposure by automatically bracketing up to +/- 2 EV in steps ranging from 1/3 to 1 EV unit. This feature lets you select either 3 or 5 shots in the series, and steps of 0.3, 0.6, or 1.0 EV units. Thus, the bracketing range could be as small as +/- 1 0.3EV, or as great as +/- 2EV. Once set, you just hold down the shutter button until all 3 or 5 exposures are captured. Very slick!

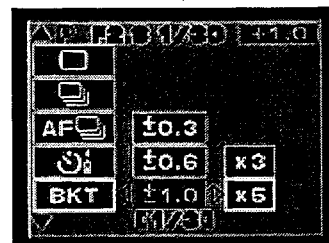

ISO is also adjustable, with available settings of Auto, 100, 200 and 400. The more sensitive settings do produce noisier images, but they provide welcome exposure flexibility. The default setting in Program exposure mode is Auto, whereas Aperture, Shutter, or Manual exposure modes force you to choose one of the explicit ISO settings. In Auto ISO mode, the camera will normally shoot at ISO 100, but will gradually increment the ISO setting in very dim conditions, trying to achieve the best tradeoff between shutter speed and image noise. We're not sure what the thresholds are for increasing the ISO rating in Auto mode, but it does seem to be pretty conservative about it: In some brief experimentation, it arrived at a shutter speed of 1/2 second (pretty slow) in a dimly-lit interior scene, yet still only bumped the ISO up to 200. "Automatic" systems like this are always a compromise, but we felt the C-3030 Zoom was doing about what we would have most of the time. It's also interesting to note that the Auto ISO settings aren't restricted to the 100/200/400 available manually - At least one of our experimental shots showed an ISO setting of 180 in the playback picture-info display.

The C-3030 Zoom provides two choices for exposure metering, Spot or the default Digital ESP metering system. Digital ESP is Olympus' name for matrix metering, but we don't know the specifics of it, how many segments it uses, etc. - For those of you unfamiliar with the term "matrix metering", it refers to a sophisticated exposure-metering technique that samples the brightness from multiple points across the image, and then applies some intelligence to set the exposure so as to not blow out highlights, plug shadows, etc.

The C-3030 offers a 12 second self-timer. You can also use the infrared remote to trigger the camera from a distance, which decreases the time delay to only three seconds. (This is one of our few quibbles with the otherwise excellent IR remote unit: Why are we forced to wait three seconds when using the remote? We'd greatly prefer relatively instantaneous triggering of the camera!) White balance can be set to Auto, Clear, Cloudy, Tungsten or Fluorescent to accommodate a variety of lighting situations. White

balance is another area where we have a request to make of Olympus: So-called "manual" white balance options are becoming more and more common on high-end digicams, and (properly implemented) they're very useful. Manual white balance options generally let you set the camera's white balance by pointing it at a white card and clicking the shutter (after appropriate menu setup, etc.) This usually provides a more accurate white balance than the automatic or preset options. The C-3030 Zoom is a sufficiently advanced camera that we'd expect to see a feature like this on it. Not a crippling omission by any means, but one that we think would be appreciated by the 3030's targeted audience of enthusiast-photographers.

The C-3030 Zoom incorporates a few entertaining options on the Picture Effect menu, enabling you to capture images in black and white or sepia tone. There are also White and Black Board settings for capturing text on light or dark backgrounds. These could be useful if you needed to grab meeting or lecture notes in a hurry. Oddly though, the resulting images, while purely black and white, are stored as RGB JPEGs, taking about the same amount of memory space as normal full-color images. This is rather odd: Overall, we'd strongly suggest just leaving the camera in color mode, and using a program like Pixid's White Board Photo to clean up the images later. (See our [review of White Board Photo](#) for more info on this unique program.)

Flash

The built-in flash on the C-3030 Zoom offers four main modes: Auto, Red-Eye Reduction, Fill-In and Off. According to Olympus' specs, the flash is effective out to 18.4 feet (5.6m) in wide angle and to about 12.5 feet (3.8 m) in telephoto. The internal flash provides good coverage in all but the widest-angle lens position: It's angle of coverage appears to correspond to a lens focal length more on the order of 35mm than the 32mm equivalent of the 3030. (Another holdover from the C-2020 Zoom?) You can adjust the flash intensity setting from -2 to +2 in 1/3 EV increments. Any of the flash modes can be combined with the Slow Sync setting, which allows the ambient lighting to make a greater contribution to the final exposure of the image. You can also produce shots which combine a motion blur on the subject (from the long ambient light exposure) with a sharp initial or final image (caught by the flash exposure). The C-3030 supports both "front curtain" and "rear curtain" triggering in Slow Sync mode, firing the flash at either the beginning of the exposure or at the end. So-called rear curtain sync is necessary to produce motion blurs on moving objects that trail the sharp, flash-exposed image, rather than precede it. A plus with the design of the C-3030 is the inclusion of an external flash sync socket, giving you even more exposure flexibility. It's important to note though, that the sync socket on the C-3030 is a proprietary design, set up for use with Olympus' FL-40 flash unit. Olympus apparently offers an accessory grip/cable combination that serves as an adapter for third-party flashes, but we don't know the model number or details on its availability.



To use an external FL-40 flash unit, the camera should be set to Aperture Priority or Manual exposure mode to control the amount of flash illumination reaching the CCD via the lens aperture setting (standard operating procedure for film cameras as well). The camera will attempt to produce a good exposure with its automatic settings, whether involving its own flash or not. Thus, if you've disabled its internal flash, you'll get a rather long exposure time in Aperture Priority mode, rather like the Slow Sync mode, whether you want that or not. Use Manual exposure mode with faster shutter speeds selected to avoid this problem. The C-3030 Zoom is unusual in that when you couple it to the FL-40 external flash, you have the option of using the internal and external flashes together. - This could be a bit of a help when you're really reaching for a distant subject, or for interesting bounce/direct flash lighting. The FL-40 also cooperates with the camera by allowing its power level to be controlled by the camera's flash exposure adjustment, mentioned above.



The manual is a bit unclear on using the 3030 with flash units other than the FL-40. To use any external flash (FL-40 or other unit), you do apparently need both the optional flash holder and flash cable. Info in the manual about third-party flashes is confusing and contradictory: In one place, it says the external flash must be used with the internal all the time. In another place, though, it says the external flash will

always fire, regardless of whether flash is enabled in the camera or not. We'll seek clarification from Olympus, but here's what we think the case is: 1) The external flash will always fire, as the sync contacts are linked to the shutter, and not affected by the internal flash status. 2) Third-party flashes won't accept flash-metering information from the camera, meaning that you'll have to regulate the light either by running the flash in Auto mode and making whatever adjustments it provides onboard, or by essentially operating the flash in "manual" mode, controlling the exposure via the camera's lens aperture.

A few caveats about external flashes with the C-3030 Zoom, or digicams in general for that matter: 1) Some external strobes have the polarity reversed on their sync connectors, and won't fire. (Cameras these days use SCRs to trigger strobes, rather than mechanical contacts, and SCRs are polarity sensitive.) 2) Some flashes put their full voltage on the sync connector, which is virtually guaranteed to blow the inner circuitry of the camera. (!) Always check the voltage on your sync connector before plugging a non-manufacturer flash into your digicam! - If you find more than a few volts there, save yourself an expensive repair, and buy a flash with a lower trigger voltage. (Studio strobe packs are particularly prone to this: Use extreme caution before attaching one to your digicam!) 3) If you're going to be shooting at wide angle, make sure your flash will cover a field of view equivalent to a 32mm lens on a 35mm camera. (Most will, some won't.) 4) If you get unexpectedly dim shots when operating at full flash power (distant subjects or small apertures), it may be that your flash is producing a light pulse longer than 1/200 of a second (Olympus' spec), so not all the light from the flash may be contributing to the exposure.

We didn't test the FL-40 with the C-3030 Zoom, but did have an opportunity to use one earlier, when we reviewed the Olympus C-2500L SLR camera. You can read our [review of the C-2500L](#) for more info on how it worked with the flash: We suspect the story with the C-3030 would be much the same. (To save you clicking the link, the short of it was that we liked the FL-40 very much indeed, and found it worked exceptionally well with the C-2500L's internal flash.)

Sequence Shooting Mode

The C-3030 offers a Sequence mode that mimics a motor drive, letting you capture between six and 12 separate pictures (depending on the complexity of the image, selected image size/quality, and the available SmartMedia space) at approximately 1.4 frames per second. In our own measurements, we indeed measured a frame rate of 1.39 frames per second at all resolutions, in autofocus mode. We discovered though, that the non-autofocus mode increased the frame rate to 3.17 frames per second (!), since the camera didn't have to wait for the lens to focus each time. The manual states that the maximum shutter speed in sequence shooting mode is 1/30 of a second, to avoid blurring. (Seems odd, we suspect it has more to do with managing the timing of the shots, rather than a concern over camera shake.) It also notes that the mode is available with all compression levels except for uncompressed TIFF. One obvious limitation of sequence mode is that the camera's internal flash may not be used with it. (The flash can't cycle at nearly 1.4 frames per second.) However, if you have an external flash capable of cycling at the 1.4 frame per second rate and shoot in aperture priority mode, you can use a flash with this mode.

Movies and Sound

The C-3030 continues the ability to record short movies, now extended to include sound. Movie mode is entered as a separate option on the main command dial. Movies may be recorded in either HQ (320 x 240) or SQ (160 x 120) resolution modes. Thanks to the C-3030 Zoom's huge buffer memory, the maximum recording time is limited only by memory card capacity, apparently up to a 32 megabyte limit. (The manual lists maximum seconds of recording time as a function of card size, but just lists "Larger than 32 megabytes" as the highest category, implying that large cards convey no additional recording time. - This makes sense, given that 32 megabytes is the size of the RAM buffer memory the C-3030 Zoom carries on board.) Here's a copy of the recording-time table from the manual:

Recording Mode	Resolution	Memory Card Capacity				
		2MB	4MB	8MB	16MB	Over 32MB
HQ	320x240 (15 frames/sec)	5	11	23	46	75
SQ	160x120 (15 frames/sec)	22	45	92	186	300

The available seconds of recording time appear in the status display panel (and in the LCD monitor if activated), based on the quality mode selected and space remaining on the card. You can use the zoom control while recording movies, but the motion of the zoom is somewhat slower than in still recording, and the zoom is apparently only a digital zoom. (Not an issue though, given the large difference between the CCD resolution and movi recording resolutions - This means that digital zoom in movie mode has the same effect as optical zoom in normal still photography, in that no image degradation should be visible as a result of using the zoom.) Manual focus, exposure compensation, focus lock, the self-timer, ISO setting, white balance and picture effects are also available while in Movie mode.

A first among cameras we've tested (May, 2000), the C-3030 even offers in-camera "editing" of movies in Playback mode. This capability is accessed via the Function->Movie Edit option on the playback menu. In this mode (see screen shot above), you can scroll forward and backward in the movie, and set cut points at the beginning and end of the sequence. Movie content between the two cut points will be preserved, the rest discarded. In a nice touch though, Olympus allows you to choose whether to modify the original movie file, or just save a new copy of it, reflecting the effect of the edit you've made. A very nice feature that we're surprised we haven't seen before. (Kudos to Olympus for thinking of it first.)

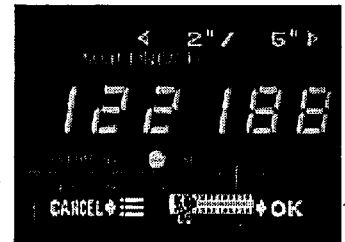

You can also record small "sound bites" to accompany images (both in Record and Playback modes). You get approximately eight seconds of record time for each image, assuming of course that there's enough space left on the memory card. This is a handy feature for "labeling" photos.

The only quibble we have with Olympus' implementation of Movie mode on the C-3030 Zoom (and it's a significant one) is that you don't get to hear the movies you've recorded when playing them back on the camera. Adding sound recording is a big feature improvement relative to the C-2020 Zoom, but it sure would be nice to at least be able to hear what you've recorded during playback. (The camera can output both video and sound to a TV or VCR via the included A/V cable, making that an effective playback mode if you have a TV handy. Still, it would be preferable to have some ability to hear a movie's soundtrack without resorting to external equipment.)

Panorama Mode

As with most Olympus digicams, the C-3030 offers a Panorama exposure mode when operating with Olympus' own panorama-enabling SmartMedia memory cards. In this mode, the exposure and white balance for a series of shots are determined by the first one taken. Images are saved individually and can then be assembled on a computer after they've been downloaded. While Panorama mode provides a useful function, it's less of an issue on cameras like the C-3030, which offer full manual exposure control. True, the panorama mode does lock the white balance in addition to the exposure, and does provide outline guides on the LCD screen to help align successive images, but doesn't offer the "ghost" images provided by some cameras to further assist image alignment. (Cameras with this feature retain a small portion of the previous image each time, moved to the other side of the LCD display, to help you line up objects in the scene with those in the frame you just captured.) The C-3030's Panorama mode also limits you to 10 exposures in the series before resetting the white balance and exposure values. Ten pictures is plenty for most situations, but almost certainly not enough if you're interested in stitching full 360 degree panoramas. For those, use Manual exposure mode, and a fixed white balance preset, such as "daylight." Overall, Panorama mode on the C-3030 Zoom is handy, but less useful than it could be, and

in our mind largely obviated by the camera's manual mode.

Shutter Lag/Cycle Times

When you press the shutter release on a camera, there's usually a lag time before the shutter actually fires. This time is to allow the autofocus and autoexposure mechanisms time to do their work, and can amount to a fairly long delay in some situations. Since this number is almost never reported on, and can significantly affect the picture taking experience, we now routinely measure it.

While the C-3030 Zoom is a very fast camera in other respects (see below), its shutter lag in full autofocus mode is at the slower end of the range: We measured shutter delay at 1.40 seconds using full autofocus. The manual focus option brought the delay down to 0.48 seconds, and prefocusing by half-pressing the shutter button before the exposure dropped the delay to only 0.15 seconds. The camera does have a continuous autofocus mode, which we expected to decrease the shutter delay considerably, since the lens should more or less always be in focus at the time of the exposure. Unfortunately, this turned out not to be the case, with shutter delays in continuous autofocus mode being on the order of 1.15 seconds (varying from 0.9 to as high as 1.3 seconds: 1.15 seconds seemed to be typical of most shots.) The C-3030 Zoom's autofocus delay is longer than most cameras we've tested, manual focus delay is about average (among camera that offer a manual focus option), and the prefocus delay is shorter than average. (Do note though, that for sports shooting, the impact of the long autofocus delay may be considerably offset by the availability of a very fast continuous-shooting mode - see below.)

Thanks to an enormous 32 megabyte RAM buffer memory, the C-3030 Zoom is an unusually fast camera from shot to shot. We've heard claims that it can capture a shot every second, but our own evaluations fell a little short of that mark. The fastest single-shot (that is, non-continuous mode) shot to shot time we measured was with manual focus selected. In that mode, the C3030 Zoom could capture an image every 1.75 seconds in its lowest resolution mode, and every 2.2 seconds in high resolution (non-TIFF) mode. It's possible there may be some additional delay if you ever managed to fill up the buffer, but we never encountered this while using the 16 MB SmartMedia card supplied with our test unit. (We filled up the memory card in a about 16.3 seconds, capturing a total of 8 shots at maximum resolution.) In autofocus mode, the lens-focusing delay increased the cycle time by about 0.9 seconds, to 2.65 and 3.1 seconds, for the low and high resolution images respectively.

We mentioned the C-3030's high speed in continuous or "sequence" mode earlier. Sequence mode has two options, normal and autofocus. In normal sequence mode, the camera focuses and calculates exposure and white balance once, as soon as the shutter button is pressed. These settings are then held for the entire series of five rapid-fire shots. In our tests, that series of five shots happened very quickly indeed, clocked at a frame rate of 3.17 frames per second. This is seriously fast for full-resolution images! In autofocus sequence mode, the camera focuses and calculates exposure and white balance for each shot in the series. This doesn't slow it down as much as you might expect though, as the camera apparently only has to make minor adjustments to the focus from one shot to the next. The end result is a frame rate of 1.74 frames per second, a very respectable performance.

Operation and User Interface

The user interface on the C-3030 Zoom relies heavily on the LCD monitor for menu selections and feedback on current settings during use. The resulting interface will be pretty clear to most users, but we do wish there were an "advanced" mode that would make greater use of the top-panel LCD data readout. The camera's non-LCD power consumption is so low that it's a shame to spoil it by requiring the LCD to be used for all but the simplest option selections. The top-panel data readout does display status information for a wide range of camera functions (see the scan below, taken from the manual), but changing most of them requires returning to the rear-panel LCD display. Here's an illustration showing the various elements of the top-panel LCD readout, courtesy of Olympus:

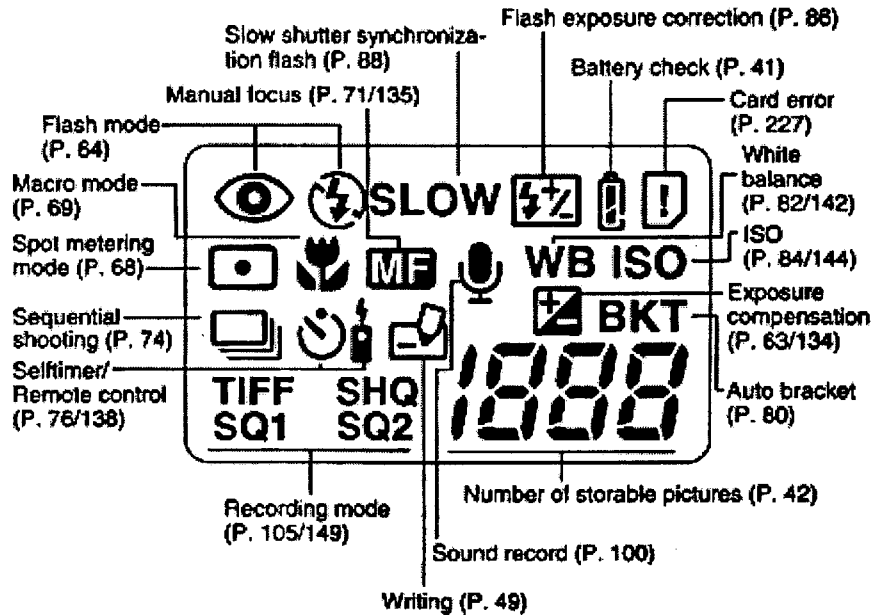

As with the C-2000 and C-2020, we liked the user interface of the C-3030 a great deal. We generally prefer mode dial interfaces like the C-3030's, as they greatly simplify the menu structure and allow faster operation. One of our favorite user interface features is that the camera tells you what aperture and shutter speed it's selected whenever the shutter button is half pressed. For photographers accustomed to knowing what their camera is doing, this sort of feedback is invaluable, and present on very few digicams we've tested. We also especially like the distance display employed in the manual focus option: Too many digicams with manual focus options give you no feedback as to the actual distance the focus is set to. In situations where there's too little light to see the subject well (or when the subject perhaps isn't in position yet), an actual distance readout is invaluable. We also liked the way the manual focus indicator has two ranges, one running from 2.6 feet to infinity, the other from 8 to 31 inches. This makes it much easier to set the focal distance accurately.



As mentioned earlier, we really like the tiny infrared remote control provided with the C-3030 Zoom, as it greatly reduces any disturbance of the camera when taking long exposures on a tripod. (This IR remote has been a feature in the Olympus line since the original C-2000 Zoom, and we've used it heavily in our own studio work, taking product shots for use on our web site.) The remote also allows you to change the exposure compensation setting or zoom the lens in and out. In Playback mode, you can scroll between pictures and move in or out of thumbnail and zoom playback modes (also helpful when viewing images on a television screen). Olympus states the range of the remote as five meters (16.4 feet) when aimed at the camera from straight ahead, and three meters (9.8 feet) when aimed from an angle of 15 degrees to either side of center. These range numbers may be correct in outdoor conditions, with lots of stray IR from the sun bouncing around: In practice, under studio conditions, we've had great luck at what seem to be greater distances, even bouncing the IR signal from the remote off the subject. A very, very handy gadget in the studio, perhaps even more so for those photographers working with children or other subjects requiring a lot of hands-on interaction. (You could connect the camera to a video monitor as a "remote viewfinder", and control most of the picture-taking from the remote.)

Control Enumeration

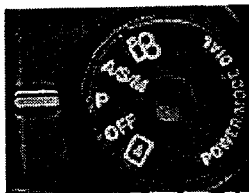

Power / Mode Dial

Located on the top of the camera, this dial selects the various camera operating modes (Playback, Off, Program, Aperture/Shutter Speed/Manual and Movie). As on the C-2020 Zoom, this dial also controls power, eliminating the frequent confusion between the power button and shutter release that plagued owners of the original C-2000 Zoom camera.



Shutter Button

Located in the center of the optical zoom control lever, the shutter button sets focus and exposure settings when halfway pressed and triggers the shutter when fully pressed. In Playback mode, the shutter button works in conjunction with the printing function to select the number of prints to make.

Zoom Lever

Located on top of the camera, surrounding the shutter button (see photo above), the zoom lever controls the optical zoom in all exposure modes. In Playback mode, the lever switches back and forth between index view, normal image display and playback zoom.



Flash / Erase Button

Located at the top of the back panel, this button controls the flash mode in all exposure modes. Pressed sequentially, it cycles through Auto, Red-Eye Reduction, Fill-In and Off modes. In Playback mode, this button pulls up the Erase menu which allows you to erase the current image displayed or all images.



Macro / Spot Metering / Print Button

Directly beneath the Flash / Erase button on the back panel is the Macro / Spot Metering / Print button. In all exposure modes, this button cycles between Macro, Spot and Digital ESP metering modes. In Playback mode, it accesses the Print screen, which allows you to set up the individual images for printing. (While we haven't reported on it, the print-setup function on the C-3030 Zoom is **much** more powerful than we've seen in other cameras to date (May, 2000), even allowing you to specify cropping for each picture!)

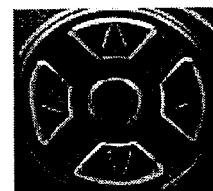

Four Way Jog Dial

Not really a "dial", but rather a set of four pushbuttons, arranged in a circular layout. Olympus moved to the four buttons on the C-2020 Zoom, from the rocker-button design of the C-2000 Zoom. The four buttons are **much** more sure-footed to navigate than the earlier toggle design, in that you never have

problems of inadvertently actuating more than one direction control at a time. Also located on the top of the back panel, a lot of the camera's operation revolves around this control. In all capture modes except Manual, a left/right actuation increases or decreases the exposure compensation setting (provided the LCD view screen is active). In Aperture or Shutter priority exposure modes, up/down actuation of the jog dial adjusts the setting of the lens aperture or shutter speed, depending on the mode you're in. In Manual mode, the up and down arrows control shutter speed while the left and right control aperture. In Playback mode, left/right actuation moves forward or back among the pictures in memory, or scrolls around the expanded image in zoomed playback mode. In the LCD menu system, the jog control steps between menus and selects settings.



OK/MF Button

Located on the back panel, on the right side of the LCD monitor, this button confirms selected menu settings when in the LCD menu screen. If pressed when not in the menu, it activates the manual focus option, which pulls up a distance scale on the LCD to assist in focusing. In Playback mode, this button write protects individual images from being accidentally erased. (Note though, that "protected" images aren't preserved if the memory card is formatted!)



Display Button

Located beneath the OK button, this turns the LCD monitor on or off.



Menu Button

Located directly beneath the Display button, this activates the menu system on the rear panel LCD monitor (it also activates the LCD monitor if it was disabled).



Dioptric Adjustment Dial: Located on the left side of the optical viewfinder, this dial alters the optical viewfinder to accommodate eyeglass wearers.

Camera Modes and Menus



Movie Mode

Accessed by turning the mode dial to the movie camera symbol, this mode allows you to capture up to 60 second SQ movies and up to 15 second HQ movies with sound. Shutter speed is automatically set anywhere from 1/30 to 1/10,000 seconds.



Aperture Priority: Accessed by turning the mode dial to the A/S/M symbol, and then selecting the "A" option from the A/S/M Mode setup submenu, this mode allows the user to select the desired lens aperture as the camera adjusts the shutter speed to achieve the correct exposure. If the required shutter speed is beyond the camera's capabilities, the aperture status number in the LCD will flash and an arrow

will indicate if under or over exposed.

A/S/M

Shutter Priority: Accessed by turning the mode dial to the A/S/M symbol, and then selecting the "S" option from the A/S/M Mode setup submenu, this mode allows the user to select the desired shutter speed while the camera adjusts the aperture to achieve the correct exposure. If the required aperture is beyond the camera's capabilities, the shutter speed status number in the LCD will flash and an arrow will indicate whether it's over or under exposed.

A/S/M

Manual Mode: Also accessed via the A/S/M setting on the mode dial, and then selecting the "M" option from the A/S/M Mode setup submenu, Manual mode allows the user to select both the desired aperture (F/2.8 to F/11) and shutter speed (16 to 1/800 seconds, depending on the ISO setting). As noted earlier, the camera tells you what it thinks of the exposure setting you've chosen, showing not only whether it thinks you're high or low, but by how much. It does this by displaying what it believes the over- or under-exposure to be using the digits on the LCD screen that normally indicate exposure compensation in automatic exposure modes. If you're more than plus or minus 3 EV units away from the correct exposure, the digits light up red, showing just +/- 3EV.

P

Programmed Exposure: Accessed by turning the mode dial to the P, this mode lets the camera select both shutter speed and lens aperture, but does so in a fairly intelligent manner, opting for faster shutter speeds when the lens is in the telephoto position than when it's working in wide angle mode.

Playback

Playback Mode: Accessed by turning the mode dial to the playback symbol, this mode allows the user to view previously captured images. Here, the jog dial advances between successive frames stored in memory. The zoom toggle switches the display to an index mode when moved in the wide angle direction and zooms in on the currently displayed image by 3x when moved in the telephoto direction. When zoomed in on an image, the jog control can be used to move the enlarged view around the full image area, letting you inspect all parts of it.

Capture Mode Menu

- **Drive:** selects between One-Shot, Sequence, AF Sequence (exposure metered with each frame), Self-Timer/Remote and Auto Bracketing.
- **White Balance:** selects between Auto, Clear, Cloudy, Tungsten and Fluorescent white balance options.
- **ISO:** sets the ISO at Auto, 100, 200 or 400.
- **Flash +/-:** adjusts the flash intensity from -2 to +2 in 1/3 EV increments.
- **Slow:** accesses the camera's slow-sync mode with options for front-curtain sync (Slow 1) or rear curtain sync (Slow 2)
- **External Flash:** sets the camera either to use both the internal and external flashes or just the external.
- **Digital Zoom:** turns the 2.5x digital telephoto feature on or off.
- **Function (Picture Effect):** allows the user to shoot in Black & White, Sepia, White Board or Black Board modes.
- **Sound:** activates the sound recording function.
- **Panorama:** activates the panorama mode (only enabled with Olympus SmartMedia cards).

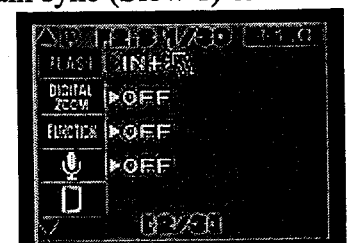
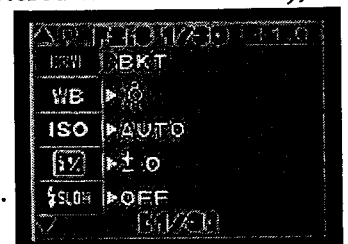

- **Card Setup:** formats the SmartMedia card.
- **Mode Setup:** pulls up the mode submenu (shown below)
- **Quality:** sets image quality at TIFF, SHQ, HQ, SQ1 or SQ2.
- **A/S/M:** sets the exposure mode at Aperture Priority, Shutter Priority or Manual.

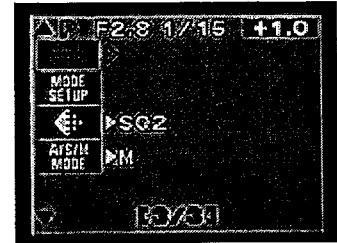

Mode Setup sub-menu (Capture Modes)

- **All Reset:** turns the all reset function on or off (on resets all settings to factory default whenever the camera is turned on). A new option on the C-3030 is the "Custom" selection here. This takes you to a five screen (!) sub-menu, letting you select default settings that will be selected whenever the camera is powered up. Settable options include flash mode, macro/spot combinations, lens zoom setting (conveniently expressed in 35mm-equivalent terms), f-stop, shutter speed, exposure compensation, manual/auto focus, LCD on/off, "drive" (single, continuous, remote/self-timer, or bracket modes), white balance, ISO, flash exposure compensation, slow sync flash mode, internal/external flash enable, digital zoom, image functions (black/white, sepia, etc), sound recording, still-mode resolution, A/S/M mode, movie-mode resolution, and info display enable. (Whew! - Basically any function of the camera can be programmed to be automatically set up when the camera powers-on. Note though, that some settings will depend on others: If the camera is set to default to aperture-priority mode, the shutter speed will adjust as required, based on the preprogrammed aperture value. Only if manual mode is preselected will the preprogrammed values for both the shutter speed *and* aperture be used.)
- **Sharpness:** sets image sharpness to Hard, Normal or Soft.
- **TIFF:** sets the TIFF resolution size to 2048 x 1536, 1600 x 1200, 1280 x 960, 1024 x 768 or 640 x 480.
- **SQ1:** sets the SQ resolution to 1600 x 1200 or 1280 x 960, High or Normal.
- **SQ2:** sets the SQ resolution size to 1024 x 768 or 640 x 480, High or Normal.
- **Volume:** sets camera volume to Off, Low or High.
- **Fulltime AF:** turns continuous autofocus on or off. Use in situations requiring slightly faster shutter response. Don't use if battery life is critical. In fast-action situations (sports, etc), use Sequence mode to rapidly shoot multiple frames, then discard unneeded shots.
- **Record View:** turns the instant image review function on or off.
- **File Name:** resets file numbers with each new card or continues in sequential order.
- **LCD Brightness:** adjusts the brightness of the LCD.
- **Date/Time:** sets the camera date and time.
- **M/Ft:** sets manual focus distance display to meters or feet.

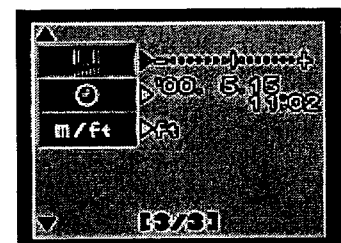
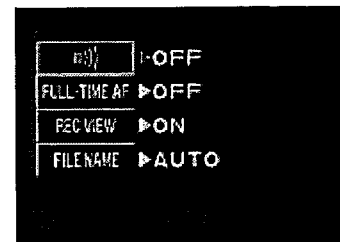
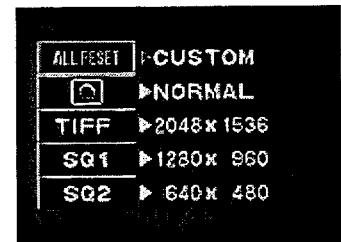

Playback Menu

- **Play:** activates a slide show display for still images or plays back movies.
- **Info:** turns the image information display on and off.
- **Sound:** activates the sound recording function.
- **Function:** for use with Olympus special function cards.

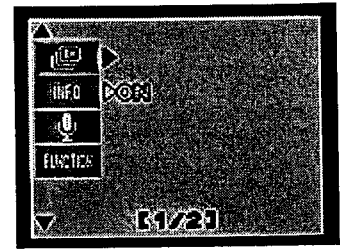

- **Card Setup:** formats the SmartMedia card.
- **Mode Setup:** brings up the following submenu:
 - **All Reset:** turns the all reset function on or off (on resets all settings to factory default on power-up), or select a preset group of Custom settings (as described above under the capture-mode setup menu).
 - **Volume:** sets annunciator beep volume to Off, Low or High.
 - **Index Display Adjustment:** sets index display to four, nine or 16 images.
 - **Brightness:** adjusts the LCD brightness.
 - **Date/Time:** adjusts the camera's date and time setting.

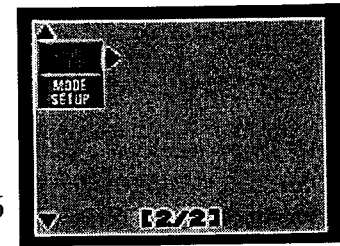
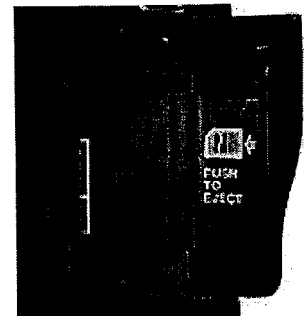

Image Storage and Interface

The C-3030 uses SmartMedia memory cards and comes packaged with a 16 megabyte card. You can upgrade to sizes as large as 64 megabytes. (From third parties, anyway: As of this writing in May, 2000, the largest card sold by Olympus themselves was a 32 meg unit. SmartMedia cards as large as 128 megabytes are planned by the end of 2000.) We like the C-3030's file naming protocol, which optionally numbers each image shot with the camera progressively, also including the month and day at the beginning of the file name. (This last is really handy for those of us who are organizationally-challenged: You can immediately tell when your photos were taken, even if you never took time to organize them by date or event.)



Entire SmartMedia cards can be write protected by placing a write protection sticker over a specific spot on the card. Stickers can only be used once and must be clean to be effective. (We're not wildly enthusiastic about the write-protect capabilities of SmartMedia cards.) Additionally, the C-3030 allows you to write protect individual images by pressing the MF/OK button on the back panel while in Playback mode. It's important to note that write-protecting individual images does not prevent them from being deleted when the card is reformatted, though.

The C-3030 comes with interface software and cables for both Mac and Windows computers, namely, a cable for the super-speedy USB interface, as well as a standard serial cable.

Following are the approximate resolution/quality and compression ratios for an 8mb card (compression numbers based on our own computations):

Resolution/Quality vs Image Capacity	2048 x 1536		1600 x 1200		1280 x 960		1024 x 768		640 x 480	
	Images	Approx. Compression	Images	Approx. Compression	Images	Approx. Compression	Images	Approx. Compression	Images	Approx. Compression
Uncompressed Quality	0	0:0	1	1:1	2	1:1	3	1:1	8	1:1
SHQ	3	4:1	N/A	N/A	N/A	N/A	N/A	N/A	N/A	N/A
Fine Quality	10	12:1	5	4:1	8	4:1	13	4:1	32	4:1
Normal Quality	N/A	N/A	16	12:1	24	11:1	38	11:1	82	9:1

And here's a more comprehensive list, showing capacities of different-sized cards. (Extracted from the C-3030 Zoom's manual.

Number of Still Pictures that can be Taken (without sound)

Recording Mode		Number of Pixels	File	Memory Capacity					
				2MB	4MB	8MB	16MB	32MB	64MB
TIFF		2048 X 1536	TIFF	0	0	0	1	3	6
		1600 X 1200		0	0	1	2	5	11
		1280 x 960		0	1	2	4	8	17
		1024 x 768		0	1	3	6	13	27
		640 x 480		2	4	8	17	34	68
	SHQ	2048 X 1536		0	1	3	6	13	27
	HQ	2048 X 1536		2	4	10	20	40	81
SQ1	HIGH (quality)	1600 X 1200	JPEG	1	2	5	11	22	45
	NORMAL			3	7	16	31	64	128
	HIGH (quality)	1280 X 960		2	4	8	17	34	70
	NORMAL			5	12	24	49	99	199
SQ2	HIGH (quality)	1024 X 768		3	6	13	26	53	107
	NORMAL			9	18	37	76	153	306
	HIGH (quality)	640 X 480		7	16	32	66	132	266
	NORMAL			20	40	82	165	331	665

Video Out

The C-3030 has a video-out port which supports the NTSC timing format on US and Japanese models (we assume that the PAL standard is supported on European models). The video output can be used for reviewing previously shot images or running slide shows from the camera, but also shows all the LCD menu screens as well as the preview display from the LCD viewfinder. Combined with the very flexible infrared remote control we mentioned earlier, the availability of a live viewfinder display via the video signal opens interesting possibilities for portrait photography, using a video monitor as a remote

viewfinder.

Actually, the output cable is a true A/V cable, as it fans out into two RCA jacks, one for video, and one for audio. As noted above, this is the only way to hear the sounds you've recorded directly from the camera, since there's no internal speaker. Plugged into any video monitor (or TV with direct video and audio inputs), the audio capabilities of the C-3030 Zoom make for an unusually effective portable presentation device.

Power

The C-3030 is powered by four internal AA Ni-Mh, Ni-Cd, alkaline or lithium batteries or two CR-V3 (Olympus LB-01) batteries. The camera ships with two of the new CR-V3 batteries in the box, but no rechargeable batteries. Do yourself a favor, and don't even use the CR-V3s in the camera, but instead put them immediately into your camera bag as a backup power source for such time as your rechargeable batteries (inevitably) are dead when just when you need them the most. Go out and buy a couple of sets of high-capacity NiMH rechargeable AA cells and a good-quality charger, and plan to use these for the main power source of the camera. The CR-3V lithium cells provide great battery life, and more or less indefinite shelf life (something like 5 years or so) in your camera bag. They thus make an absolutely excellent backup power source that'll always be ready when you need it. For routine use though, they're just too expensive, at something like \$10 apiece. (A pair? - no matter, still way too pricey, IOHO.)

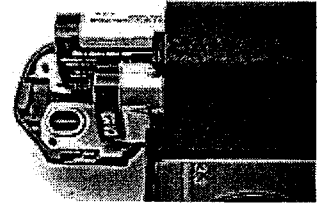

Earlier cameras in this series from Olympus (the C-2000 Zoom and C-2020 Zoom) were surprisingly efficient in their battery usage, particularly if you kept the LCD display screen turned off. The C-3030 Zoom continues this happy tradition: It's "idling" power in capture mode with the display off is almost nil, meaning you can comfortably leave the camera on all day, so it'll always be ready whenever you want to take a picture. This is a very nice feature, and really increases its usefulness. Despite this thrifty battery usage, we still strongly recommend that you pick up a couple extra sets of high-capacity rechargeable batteries and a decent charger. Here's a table showing the C-3030's power consumption in a variety of operating modes. (Overall, it has very good power efficiency for a three megapixel camera: A good set of NiMH AA cells should easily last for a full day's shooting, if you can just avoid the temptation to ogle your pictures on the LCD monitor.)

Operating Mode	Power Drain
Capture Mode, w/LCD	610 mA
Capture Mode, no LCD	< 10 mA
Half-pressed shutter w/LCD	620 mA
Half-pressed w/o LCD	340 mA
Memory Write (transient)	590 mA
Flash Recharge (transient)	(not measured)
Image Playback	460 mA

Memory Retention

We don't normally comment about memory retention in digicams (clock/calendar, settings, etc), but at least one other internet reviewer has knocked the C-3030 Zoom for losing its memory if the batteries are removed for more than an hour or so. So much has been made of this in various discussion forums and newsgroups that we felt compelled to comment. While it is certainly convenient for cameras to have a separate lithium battery to provide backup power to the clock/calendar chip and settings memory, the C-3030 is by no means unique in lacking that feature. The earlier C-2000 had a backup battery, but the

C-2020 did not. More to the point, the Nikon Coolpix 990 (with which the C-3030 directly competes) does not either, meaning that it will lose its date/time setting at least as fast as the C-3030 Zoom will. True, the Canon Powershot S-20 does have a clock backup battery, but we don't feel it's fair to single out the C-3030 Zoom on the basis of this one deficiency. For our part, we invariably leave one set of our NiMH batteries in our digicams all the time anyway. It's true that NiMH cells have a relatively short shelf life, but not nearly to the extent that other authors have represented: Some have claimed that NiMH cells lose 5% of their charge per day: While some cells may show this level of self-discharge, we've more often heard quoted a figure of 1% per day, and this matches our own (non-quantitative) experience more closely. Thus, while we would clearly like to see a lithium clock-backup battery in the C-3030 Zoom, we don't feel it deserves any special condemnation for its lack thereof.

Included Software

The C-3030 comes with a very nice complement of software on an included CD. Direct camera control and image downloading are provided by an updated version of Olympus' own Camedia software package (version 2.0) which allows you to download and save images to your hard drive, and provides rudimentary organization capabilities. We confess to slightly mixed feelings on the other half of the package though: On the downside, we were chagrined to see that the excellent panorama-making program QuickStitch (from Enroute Software) is no longer included in the software bundle. On the upside though, the even more useful (at least to the majority of users) Photoshop LE version 5.0 is included. (Even better, all software packages provided are fully functional on both Mac and PC.) While there are many other image-processing programs out there, Photoshop is consistently our favorite, thanks to the level of control and features it provides. The "LE" version of Photoshop lacks only a few of the features of the full-retail version (notably color management tools and support for non-RGB color spaces), and is entirely suitable for use by the serious digicam owner. Adobe recently began selling Photoshop LE on the open market (previously, it was only available in software bundles like this), and its \$99 retail price is a very valid representation of its value. Thus, if you don't already own Photoshop, buying a C-3030 Zoom could end up saving you a very real \$99 relative to where you'd likely end up anyways. So, while we miss the incredible QuickStitch panorama-maker, including Photoshop LE is a huge plus.

Test Results

In keeping with our standard policy, our comments here are rather condensed, summarizing our key findings: For a full commentary on each of the test images, see the [C-3030 Zoom's "pictures" page](#).

As with all Imaging Resource camera tests, we encourage you to let your own eyes be the judge of how well the devices performed: Explore the images on the [pictures page](#), to see how well the C-3030 performed, and how its images compare to other cameras you may be considering buying.

Overall, the C-3030 Zoom produced exceptional images, befitting its status as a top-of-the-line 3.3 megapixel digicam. Color accuracy was good, although our shots of the MacBeth(tm) chart showed a somewhat warm cast with all white balance settings, and the bright yellow patch had slightly lower color saturation. (A common digicam problem.) Overall, we felt the color was quite good, however.

The Olympus C-3030 performed toward the top of the current range of 3.3 megapixel digicams in the resolution department, with a resolution that we "called" as between 850 and 900 lines per picture height in both the horizontal and vertical directions. While just a hair off from the sharpest performance we've seen to date, the 3030 deserves credit for not applying heavy-handed in-camera sharpening in an attempt to boost the apparent resolution.

As did the 2 megapixel C-2020 Zoom before it, the C-3030 Zoom offers excellent exposure control, with choices of matrix or spot metering, full aperture and shutter control, including an optional manual mode, and ISO speeds ranging from 100 to 400. The C3030 Zoom performed very well in our low light tests, producing very usable images down to light levels of 1/8 of a foot-candle. (We're chiding ourselves for not having gone down to 1/16 of a foot-candle, since it's our guess that we would have obtained usable if not somewhat dim pictures at that level as well.) At these low light levels, with exposure times of 2 to 10 seconds, there is a moderate amount of noise present in the images. (We direct readers to Mike Chaney's

excellent Qimage Pro program, for a tool with an amazing ability to remove image noise without significantly affecting detail.) To put the C3030's low light performance in perspective, an average city night scene under modern street lighting corresponds to a light level of about 1 foot-candle.

We found the C-3030's optical viewfinder to be a little tight, showing approximately 82 percent accuracy at wide angle and about 81 percent at telephoto. (Note that we've changed our nomenclature on this to better reflect what you see looking into the viewfinder: We previously would have referred to the C-3030's viewfinder as "loose"...). These numbers are from the 2048 x 1536 resolution size but the smaller, 640 x 480 resolution size numbers are similar at 83 percent accuracy for both wide angle and telephoto. We also noticed that the framing here slants just a little to the left vertically, possibly the CCD on our test model was shifted a little. The LCD monitor proved to be quite accurate, showing about 97 percent frame coverage at wide angle and slightly over 100 percent accuracy at the telephoto setting. (The covered area is just barely inside the darker lines we use to frame the viewfinder accuracy target). As with the optical viewfinder, the smaller, 640 x 480 image sizes weren't too far off from the larger ones (about 96 percent accuracy at wide angle and over 100 percent accuracy at telephoto). We generally like to see the LCD monitor as close to 100 percent accuracy as possible, so the C-3030 does a pretty good job in that respect.

The C-3030 does pretty good job in the macro category, capturing a minimum area of 3.35 x 2.52 inches (85.21 x 63.91 mm). This is about an average minimum coverage area among digicams we've tested, but the body threads of the C-3030 in conjunction with Olympus' CLA-1 filter adapter permit the addition of external macro lenses for much tighter focusing.

Overall, we found the C-3030 Zoom to be a very worthy contender at the upper end of the current (May 2000) digicam spectrum. Image quality, resolution, and sharpness are all very good, and the camera provides excellent exposure control as well as very good low light capability: An impressive performance!

Conclusion

Well, from our previous review of it, it's probably pretty clear that we really liked the previous Olympus C-2020 Zoom. (We like it well enough in fact that it's the camera we use to do all our studio photography with.) The C-3030 Zoom is a very worthy upgrade, bringing not only increased resolution but numerous feature and user-interface enhancements as well. It's probably safe to say that if you liked the C-2020 Zoom, you'll love the C-3030 Zoom. All in all, another great digicam from Olympus, and one that we think competes very strongly at the upper end of the current "prosumer" digicam spectrum.

Reader Comments!

See what other Imaging Resource readers have had to say about the C-3030, or add comments of your own. (*Read what's here, then add your own!*)

For even more feedback, read the [User Reviews from PCPhotoREVIEW](#)

Reader Sample Images!

Do you have a Olympus C-3030 camera? If you'll post an album of your samples that we can point to with a single URL (not all services permit this, some require you visit the main site and type a name and password) and email us at web@imaging-resource.com, we'll list the album here for others to see!

- [Sample pictures from PCPhotoREVIEW readers](#)

For More Info:

View the [C-3030 Sample Pictures Page](#)

[View the Imaging Resource Data Sheet for the C-3030](#)

Visit the [Comparometer\(tm\)](#) to compare with other cameras.

Visit the [Olympus home page for the C-3030](#)

[Back to the Imaging Resource Digital Cameras Page](#)

Or, [Return to the Imaging Resource home page.](#)

This document copyright (c) 2000, The Imaging Resource, all rights reserved. Visitors to this site may download this document for *local, private, non-commercial use*. Individuals who have *themselves* downloaded this page may print a copy on their personal printers for convenience of reading and reference. Other than this explicit usage, it may not be published, reproduced, or distributed in print or electronic and/or digital media without the express written consent of [The Imaging Resource](#).

GREAT PRICES	Digital Camera Memory	
	IBM Microdrives & Readers	
	Photo Quality Printers	

This page has been formatted to facilitate printout of the review.

Use your browser's "Back" button to return to the previous page, or the links at the top and bottom of this page to navigate to related information. If you have difficulty fitting the text on this page onto your printer output, simply resize your browser window to a narrower width and print again.

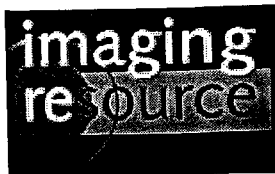

[Back to Full Nikon Coolpix 990 Review](#)
[Go to Nikon Coolpix 990 Data Sheet](#)
[Go to Nikon Coolpix 990 Pictures Page](#)
[Up to Imaging Resource Cameras Page](#)



Nikon Coolpix 990

Nikon updates the hugely successful Coolpix 950, with 3.34 megapixels and numerous enhancements

(Review first posted 3/1/2000)

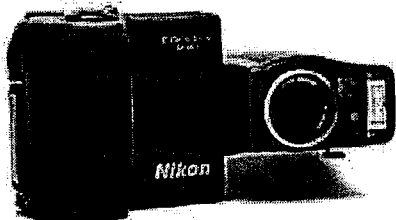

- *Full 3.34 megapixel sensor delivers 2048x1536 images
- *Exceptionally well-designed user interface and controls
- *32 Megabyte SDRAM buffer for 2 second cycle time
- *Enormous creative control and flexibility
- *Excellent color and tonality

Manufacturer Overview

By carefully applying their camera-building expertise honed in the professional and advanced-amateur segments of the film-camera market, Nikon has developed a commanding position in the digicam world, even though their consumer digital camera lineup has consisted of only two models. The key has been the exceptional image quality and picture-taking feature set embodied in their cameras, which have obviously struck a responsive chord with digicam enthusiasts. When the 1.3 megapixel Coolpix 900 first burst on the digicam scene almost two years ago, it was an immediate hit. The 2.1 megapixel Coolpix 950 a year later extended the winning streak, and now the 3.34 megapixel Coolpix 990 appears poised to do the same again. (Meanwhile, the Coolpix 800 has been a popular choice for an inexpensive 2 megapixel digicam with a slightly less robust feature set.)

Besides increasing the 990's resolution to a full 3.34 million pixels, Nikon has also upgraded several camera functions, added numerous features, and improved the camera's physical design.

Highlights

- 3.34 megapixel, 1.13 inch, high-density CCD delivering image sizes up to 2048 x 1536 pixels (including a 3:2 aspect ratio 2048 x 1360 pixel size).
- 1.8 inch, 110,000 dot, low temperature, polysilicon TFT LCD display.
- 3x optical zoom, 8 to 24mm lens (equivalent to a 38 to 115mm lens on a 35mm camera).
- User activated digital telephoto in incremental steps from 1.1x to 4.0x.
- Continuous and Single autofocus modes with multiple focus areas and manual focus with peaking and distance readouts.
- Infinity and Macro focus modes.
- Variable ISO at Auto, 100, 200 or dEF.
- Full Automatic and Manual exposure modes with several manual options (Program, Flexible Program, Aperture Priority, Shutter Priority and full Manual).
- Single, Continuous, Ultra High Speed Continuous, VGA Sequence, Multi-Shot 16 and Movie shutter modes.
- White balance with Auto, Manual, Fine (Outdoors), Incandescent, Fluorescent, Cloudy and Speedlight options.
- Shutter speeds from eight to 1/1000 seconds as well as a Bulb setting for longer exposures.
- 10 or three second self-timer.
- Built-in flash with Auto, On, Off, Slow Sync and Red-Eye Reduction modes.
- External flash sync terminal.
- USB and Serial interfaces.
- Image capture in compressed JPEG or uncompressed TIFF.

What's New

Since many people reading this review will be familiar with the previous Coolpix 950, it makes sense to begin with a list of the new features Nikon has included on the 990. As you can see, engineering the 990 was more than a matter of just slapping a larger sensor into an existing design. Here's a (doubtless partial) list of what's new:

- 3.34 million pixel sensor, up from 2.11 on the 950.
- 5-zone autofocus system, for greater AF accuracy (inherited from Nikon's pro film and digital SLR cameras).
- 50-step manual focus, with "peaking" indicator.
- 7-blade iris diaphragm, providing true 1/3-stop aperture control.
- 256-element Matrix white balance for improved auto white balance accuracy.
- Optional user "fine tuning" of white balance settings.
- Both full-manual and auto-bracketing exposure options.
- A rugged, side-opening CompactFlash memory slot. (BIG kudos for that!)
- "Stepless" digital zoom, from 1.1 to 4.0x magnification
- USB interface option for high-speed file downloads
- Easier menu navigation via a rear-panel jog control
- Spot metering optionally linked to area autofocus system
- Variable image sharpness settings

- Ability to use self-timer function while in macro focusing mode. (A top request!)
- User-selectable NTSC or PAL video output
- Histogram-based exposure confirmation option
- Smaller, but higher-resolution LCD panel
- "Memory" for last-used zoom lens setting
- Optional fixed-aperture zoom mode

Executive Overview

We're pleased to report that the Coolpix 990 takes all the best features of the previous 900 and 950 models and combines them with a host of new ones that make this camera really shine. The swivel-lens design is one of our favorite design elements, as it greatly enhances the camera's optical flexibility. Additionally, the control layout stayed relatively the same but with a few additional features, such as the programmable Function buttons. (These programmable buttons make one handed operation of the camera much more feasible under varying conditions.) The camera provides both a real-image optical viewfinder and an LCD monitor display for image composition. A nice feature on the LCD is the very extensive information display that reports a variety of exposure information, including aperture and shutter speed settings. In Play mode, the LCD gives an equally informative readout on captured images and also offers an index display of thumbnails and a playback zoom option.

Optically, the Coolpix 990 is equipped with a 8 to 24mm, 3x zoom lens (equivalent to a 38 to 115mm lens on a 35mm camera), made up of nine elements in eight groups (all made from environmentally friendly glass, we might add). New to the 990 is the seven blade iris diaphragm design, which greatly extends aperture control over the earlier 950. Zoom is easily controlled via the W and T buttons on the back panel and the settings menu even allows you to select the Fixed Aperture feature, which keeps the aperture constant while the lens zooms. A 4x digital zoom can be turned on and off through the settings menu and offers an "stepless" incremental zoom range from 1.1x to 4.0x. We should also mention here, that the 990 has a nice variety of focusing options, including Continuous and Single autofocus as well as a manual control. Under the autofocus setting, you can set the desired focus area, or let the camera decide on its own (which displays a complex target series on the LCD panel and bases focus on the object closest to the lens). With manual focus, you can select a peaking feature that shows what part of the image is in focus, as well as a distance scale to help in difficult situations.

Exposure-wise, we greatly enjoyed the flexible options under the Manual Record setting. When you turn the camera on, you have the option of a completely Automatic or Manual Record mode, in addition to the Play mode. Under the Automatic Record mode, the camera handles everything, from the shutter speed to the white balance, but when you switch to Manual Record, your options multiply greatly. Within the Manual Record mode, you can select either Program, Flexible Program, Aperture Priority, Shutter Priority or Manual exposure modes. Program does exactly as it sounds and selects the aperture and shutter speed, but you now have absolute control over white balance, exposure compensation, etc. Flexible Program does the same but instead lets the user select from a variety of aperture and shutter speed combinations. Aperture Priority and Shutter Speed Priority are also pretty self-explanatory, letting the user select one value while the camera selects the other. Finally, Manual gives you total control over everything, a feature we really like. Shutter speeds are adjustable from eight to 1/1000 seconds (with a bulb setting for longer exposures) and apertures range from F/3.5 to F/9.8.

The Coolpix 950 already offered outstanding features like Best Shot Select and a variety of continuous shooting modes. These are all repeated on the 990 and accompanied by a few new ones. In addition to the Continuous and Multi-Shot 16 shooting modes, the 990 also offers an Ultra High-Speed Continuous (approximately 30 frames per second with a total of 80 QVGA shots) and a Movie mode (up to 40 seconds of QVGA sized images at 15 frames per second). There's also an Auto Bracketing feature that brackets as much as two stops up and two stops below the set exposure, producing a total of five images. We really enjoyed these features and the amount of creativity and flexibility they allow. We were also

pleased with the return of the extensive white balance menu from the 950 (Auto, Preset, Fine, Cloudy, Incandescent, Fluorescent and Speedlight) and the variety of metering options (the famous 256-element Matrix mode, Center-Weighted and Spot). Also, under the settings menu, we enjoyed the ability to alter the in-camera sharpening as well as increase or decrease the contrast or turn the image into monochrome black and white. Not to mention the ability to connect an external flash and use with or without the built-in flash. This camera is so feature laden, it's hard to find lack to complain of.

The Coolpix 990 uses CompactFlash for image storage and runs on four AA batteries. We found the camera a little power hungry (partly because of our reliance on the LCD monitor during the studio shots), so we highly recommend keeping a couple sets of spares around or working with the AC adapter when possible. The camera supports both USB and standard serial connections (using a dual purpose port), for quick connection to a PC or Mac. (The availability of a USB connection is decidedly good news on a high-resolution camera, especially one that can make nearly 10 megabyte uncompressed TIFF files like the '990!) There's also an NTSC video cable (European models ship with PAL) for connecting to a television set.

What a camera! We really love the almost excessive amount of control and think that you will too. The Coolpix 990 gives you as much control as you want, but also offers the luxury of sitting back and letting the camera do all the work as well. With its bevy of exposure options, compact portability, and high image quality we think this camera will be very popular.

Design

Nikon continues the swivel-lens design of the Coolpix 900 and 950 models with the Coolpix 990. With its ability to swivel just shy of 360 degrees, the lens can be pointed back towards the user, straight ahead or straight down to the ground, while keeping the LCD screen oriented for easy viewing. The camera body is compact and light weight, measuring approximately 5.9 x 3.1 x 1.5 inches (15 x 7.87 x 3.81 cm) with the lens stowed in its upright position and weighing about 13.1 oz (371.4 g) without the batteries.



With the lens facing forward in its normal "stowed" position, the design of the front of the camera remains quite minimal. The lens itself doesn't protrude much from its barrel and the built-in flash and front side of the optical viewfinder fit snugly beside it. Beneath the lens barrel are the external flash sync socket and the dioptic adjustment dial for the optical viewfinder. On the very inside of the hand grip is the DC power input jack, covered by a soft rubber flap. Interestingly enough, Nikon swayed from their usual black and red design features to an updated combination of black and purple, and a rainbow reflective logo on the front.

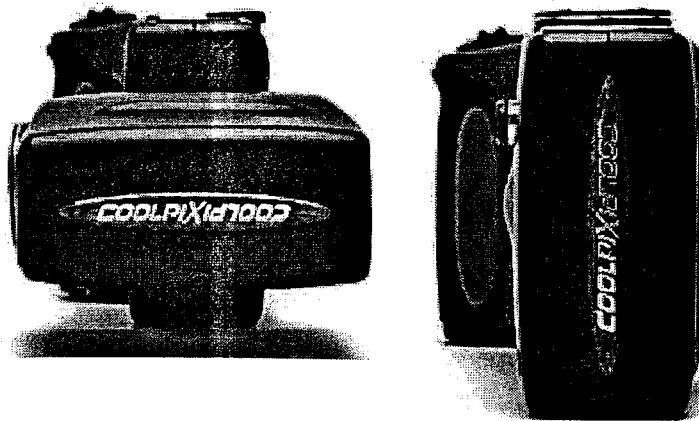

This shot shows the camera with the lens unit rotated to the position most people will use it in. This orientation orients the LCD panel vertically, while the lens, flash, and optical viewfinder face forward.

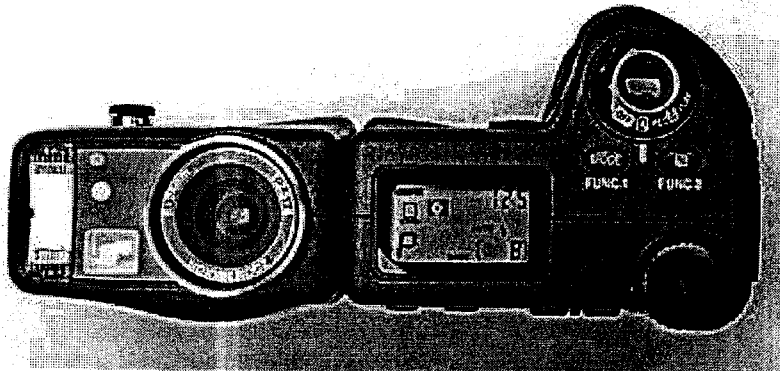

Looking at the top of the camera body, there's a small status display panel (helpful for conserving batteries by not using the LCD monitor), the Power/Mode dial, shutter button, a couple of function buttons and a small command dial that's used to change certain camera settings. An exceptional feature on the 990 is that the Mode and +/- buttons on the top panel also double as Function buttons, programmable through the Setup menu in Manual exposure mode to access various exposure options. This was designed specifically to allow one handed operation, as you can hold down one of the buttons with your index finger and scroll through the chosen options with the command dial. This is a nice design change from the earlier Coolpix models, which were decidedly two-handed cameras.



The majority of the controls are located on the back panel of the camera, along with the LCD monitor. The layout of the controls is, again, very similar to the preceding Coolpix models. The Monitor and Menu buttons live at the top of the LCD panel, with the zoom controls and rocker toggle button off to the right side. Beneath the LCD are several controls for macro, manual focus, flash, quality, size and a few others. When the lens is pointed frontwards, the optical viewfinder is visible from the back panel. Two LEDs located directly beside the viewfinder report the status of the autofocus and flash.

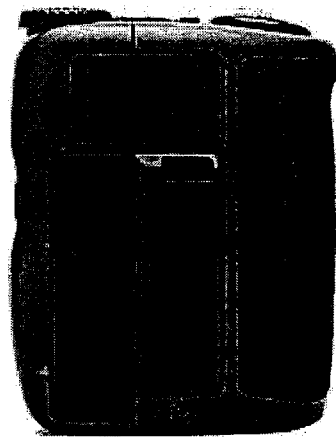

We like the bulky hand grip on the right side of the camera which enables a firm, secure hold on the camera. (We noted that this feature is somewhat larger on the 990 than the earlier 950, making for a more secure grip.) The soft rubber surface fits directly under your fingers, providing additional friction for a good grip. Located inside the hand grip are the serial and USB I/O jack (a dual interface), the video output jack, the CompactFlash compartment and an attachment for the carrying strap. The digital and video inputs live beneath a soft, flexible rubber flap that quickly and securely snaps into place. The placement of the CompactFlash slot makes it easy to change cards when mounted to a tripod and the plastic door simply flips open and snaps shut. (The sturdy design of the CompactFlash door addresses the single most frequent complaint of 950 owners: The flimsy plastic flap used to cover the memory slot on that model. There is no access light to let you know when the camera is accessing the card, so you'll have to pay attention to the LCD monitor or the small status display to know when it's OK to change cards. (It's important to never remove a memory card while the camera is writing to it, lest you corrupt your images or even damage the card.)

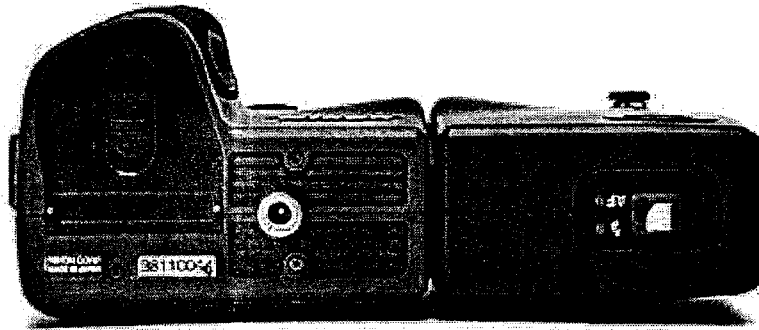

Finally, the flat bottom of the camera holds the battery compartment and a metal tripod mount that are unfortunately too close together to allow battery changes while on a tripod. The battery compartment has a sliding lock that keeps the door tightly shut.

Viewfinder

The Coolpix 990 offers both an optical viewfinder and an LCD monitor display. The real-image zoom viewfinder, located on the backside of the lens barrel, provides about 85 percent frame coverage according to Nikon. In our own tests, it ranged from 86 percent coverage at wide angle to 91 percent at telephoto. A center focus target helps line up shots while two LEDs beside the viewfinder indicate the status of the flash and autofocus systems. Additionally, a diopter adjustment dial lies on the underside of the lens barrel to accommodate eyeglass wearers.

The 1.8 inch, 110,000 dot, low temperature, polysilicon TFT LCD monitor on the back panel operates both as a viewfinder and information display while in any capture mode. The LCD on the 990 is smaller than that on the earlier 950, but is higher resolution. It also sports a very high refresh rate, so images of moving objects are sharp and clear. Nikon estimates its frame coverage at 97 percent, a good deal more accurate than the optical viewfinder, which is usually the case. Our own tests showed it 97 percent accurate at wide angle, and nearly 100 percent at telephoto. When the camera is in autofocus mode, a series of targets can be continually displayed on the LCD. This shows you all the areas that the camera looks at to determine focus (in this autofocus mode, the part of the subject closest to the camera determines the focus). The LCD monitor display can be quickly called up and canceled by hitting the Monitor button just above it and we applaud the amount of exposure information that's displayed. Nearly all the settings are reported, including aperture and shutter speed (when in Manual exposure mode).

We felt the LCD screen was a minor weakness in earlier Coolpix cameras, as the unit used by Nikon was very difficult to read in sunlight. (This is true of all LCD screens, but seemed more so of the displays on the Coolpix 900 and 950.) We felt the viewscreen on the 990 was much better in this respect: It seemed to trade off a narrower usable viewing angle (you need to look at it pretty much straight on, for the best view) in favor of less tendency to wash out in very bright ambient light. The 990's LCD is also the first we've seen (February, 2000) that had an adjustment in the setup menu to control the screen's color balance, in addition to the common brightness setting. (!) We found this very interesting, perhaps useful as a way to adapt the camera's behavior to surroundings with strong tints in the ambient lighting.

As was the case with the Coolpix 950, an exceptional level of exposure information can also be displayed in Play mode. The screens at right show the three successive information screens that are accessed by rotating the command dial in playback mode. (The image in the screen shots here was deliberately underexposed using Manual capture mode, to make the information display more visible.)

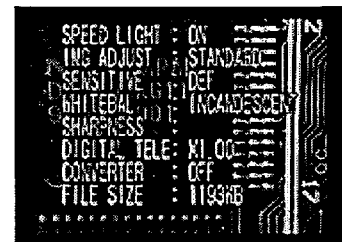
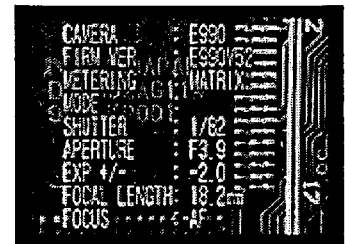
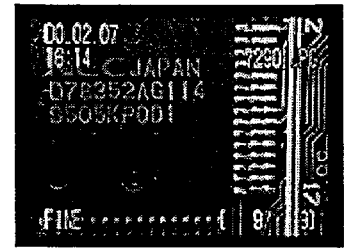

Completely new in the Coolpix 990 (and very welcome!) is the histogram display shown at right. This is a feature that has been common in professional digicams for some time now, but that has seldom been seen in "prosumer" models. The graph shows the distribution of brightness values in the image, with the left edge corresponding to pure black, and the right edge to pure white. Once you learn how to read it, a histogram is phenomenally useful in determining whether you've managed a good exposure or not. There's hardly room or time here to go into histograms in full detail, but we thought it would be useful to show you two examples: In the screen shot at top, the image was deliberately underexposed. Note how the peaks in the histogram are all bunched toward the left-hand side of the graph, and how little there is going on at the right side. By contrast, the lower image was overexposed. Note how the graph is bunched against the right edge. Ideally, a well-exposed image would produce a histogram curve that just filled the graph from left to right, indicating that it contained a full range of tonal values. We really like the histogram feature, and hope other digicam makers will be motivated to include it in their cameras as well.

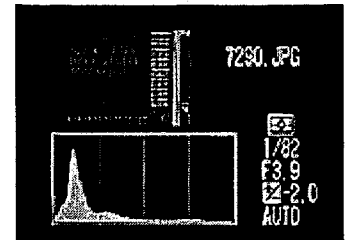

A final Play-mode information display is also new to the 990, showing lens, shutter and focus settings, and indicating (by the green brackets) what the autofocus system had locked onto when the picture was taken. -Another very handy way to check that you actually got the shot you were looking for!

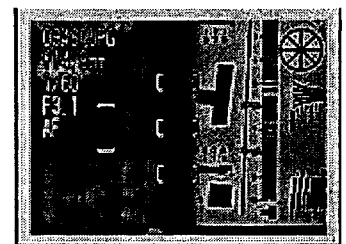

In Play mode, the LCD can also display a thumbnail index page, showing either four or nine images to a page depending on the setting. You can cycle between single-image, four or nine image views by pressing the flash/thumbnaill button under the LCD display. You can also mark images for deletion in this mode.

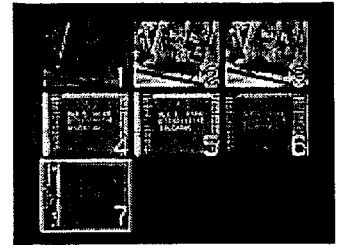

There's also a playback zoom feature, which enlarges captured images up to 3x, letting you get a reasonably good idea of how well-focused the image is, check the framing, and examine details to see if you got the shot you wanted. (Did anyone blink?)

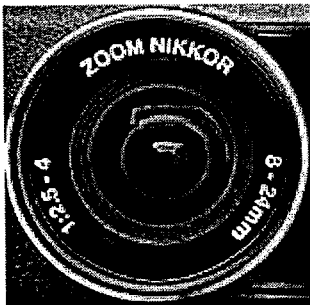
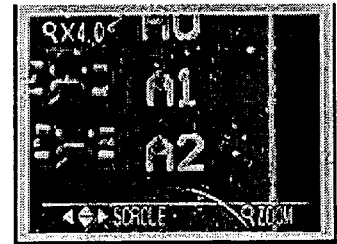

Optics

A Nikkor 3x zoom, 8 to 24mm lens comes with the camera (the equivalent of a 38 to 115 mm lens on a 35mm camera), with nine elements in eight groups (all made up of environmentally friendly glass). Aperture ranges from F/3.5 to F/9.8. New to the 990 model is the seven blade iris diaphragm, which gives very fine-grained aperture control, useful for controlling depth of field, but more so for working with external flash and precisely controlling the balance between flash and ambient exposure. The contrast-detect TTL autofocus features a 4,896 step autofocus mechanism with a working range from 0.8 inches (2.0 cm) to infinity (this includes the macro range). When shooting in the Auto exposure mode, the autofocus remains in the Continuous setting while using the LCD monitor but reverts to the Single autofocus mode when the LCD is off (which means you must halfway press the shutter button to set focus). However, the Manual capture mode gives you the freedom to choose between Continuous or Single autofocus, regardless of LCD status.

The Continuous focus mode results in the lens continually "hunting" for the best focus as you move the camera around, settling down when the camera and/or subject stops moving. Autofocus tracking speed isn't terribly high (mentioned in case you were expecting AF tracking as on Nikon's F5 pro film camera), but the continuous option would definitely be a benefit with moving subjects. The downside is that it burns more battery power.

The manual focus option is controlled through the settings menu and offers choices between a peaking scale or a distance readout (extremely beneficial in hard to focus situations). Once enabled, just press the Manual Focus button (lower left of the LCD monitor) and simultaneously turn the command dial to adjust the focus in 50 steps.

As a focus aid in manual focus mode (it can also be enabled in autofocus modes as well), the Coolpix 990 has a clever "peaking" display. This appears to be some sort of on-screen sharpening function that tends to exaggerate the current state of focus of the camera: In-focus objects look extra-sharp on the LCD when "peaking" is enabled. With textured objects, the peaking display mode produces a glimmering, moire-type effect on the display screen. We didn't test manual-focus accuracy extensively, so can't comment on just how well this works, but it is clearly a step ahead of most digicams, in which

between the Auto and Manual exposure options on the Power/Mode dial is the availability of certain functions. For example, in Auto exposure mode, the camera completely controls the exposure, from shutter speed to white balance. The Manual setting provides the full range of options mentioned above, giving you as much or as little control as you need. We'll explain the various modes here.

Program mode gives the camera control over shutter speed and aperture but lets you set the white balance, exposure compensation, etc. The Flexible Program option goes a step further by letting you select from a range of shutter speed and aperture combinations. (The camera determines the required exposure, but you can choose whether it achieves that exposure with a shorter shutter speed and wider aperture, or a longer shutter speed and smaller aperture. This strikes us as a very nice option, achieving much of what people want from Shutter or Aperture priority modes, but without limiting the camera's ability to respond to widely varying light conditions.) Shutter Priority lets you select from eight to 1/750 second shutter speeds while the camera selects the appropriate corresponding aperture. Likewise, under Aperture Priority, you can select apertures from F/3.5 to F/9.8 while the camera selects the best shutter speed. However, in Full Manual mode, the camera increases the shutter options to include a bulb setting for long exposures and a quick shutter of 1/1000 seconds, with the same aperture range as in Aperture Priority. In any mode, if the camera disagrees with your exposure choices, the shutter and aperture values will flash in the display to indicate that this may not be the best exposure option.

Exposure compensation is adjustable from -2 to +2 in 1/3 EV increments by pressing the +/- button and turning the command dial. Additionally, under the Image Adjustment option on the settings menu, you can increase or decrease contrast, lighten or darken the entire image or switch into black and white mode, giving you a few more exposure adjustment options. These tonal compensation adjustments are quite a bit more sophisticated than simple exposure compensation found in most digital cameras. Conventional exposure compensation adjustments simply allow you to adjust overall exposure up or down relative to that selected by the camera's exposure system. By contrast (no pun intended), the "lighten" and "darken" adjustments on the Coolpix 990 preferentially adjust the midtone values of the image, without affecting the white and black values of the image. (That is, "lighten" will brighten the middle brightness values in the image, without blowing-out white areas, or lightening black ones.) There are also options to adjust contrast, and capture images in black and white.

The Coolpix 990's default ISO rating is 80 but is variable when shooting in Manual exposure mode. ISO values of dEF(default), 100, 200, and Auto are available by pressing the ISO button and rotating the command dial. When shooting in the Auto exposure mode, the ISO value is left at its default setting of 80. In addition to the exposure value settings, you can adjust the in-camera sharpening to Auto, High, Normal, Low or Off under the Sharpening option of the settings menu. This is a useful feature, especially in situations where digicams tend to oversharpen such as high contrast boundaries within images. Also, we generally find that post-exposure sharpening in Photoshop(tm) or other image-manipulation program generally gives better results than the in-camera sharpening functions provided by most cameras. Thus, you may find it best to leave the in-camera image sharpening in the Coolpix 990 off for critical images, and apply unsharp masking in the computer later.

Histogram-based exposure confirmation.

We showed examples of the Coolpix 990's histogram display earlier, under our discussion of the viewfinder functions. Given that prior coverage, we'll make only brief mention here, but do want to underscore the significance of this feature. Shooters moving from the color-negative world will be accustomed to routinely favoring overexposure in their pictures, to insure optimum shadow detail. Digital cameras are quite different though, and need to be exposed more like slide film, with an eye to retaining detail in the highlights: Once the sensor hits an exposure value of 255 (in a system with 8-bit brightness values), any additional illumination has no effect, and all highlight detail is lost. It's thus very important to be able to recognize when parts of the image are being "blown out", as opposed to merely being very bright. LCD viewscreens aren't accurate enough to be trusted for this evaluation, so an explicit graph of brightness values (the histogram display) is exceptionally useful. We don't expect most casual users to routinely use the histogram exposure confirmation display on the 990, but for pros or others working with critical exposure requirements, it's indispensable.

the LCD screen has far too little resolution to be of practical use in evaluating focus.

We should note here that the 990's autofocus mechanism is quite sophisticated, with several operating modes. It has five possible focus zones (center, top, bottom, left, right), which can be very useful for achieving accurate focus on off-center subjects. The screenshots above right show the camera preferentially focusing on two objects at very different distances, based on the focus area selected. It could also take some getting used to if you're accustomed to lesser cameras with only a single focus zone. The Focus option under the settings menu does allow you to choose modes in which the camera chooses the focus zone, or in which you can explicitly set the location of the focus area (a nice feature that works well when combined with the spot metering mode, which can likewise be directed to determine exposure from the same 5 zones). In the "Auto" option for focus-area selection, the camera chooses the area corresponding to the object closest to the camera. When the area focus option is set to Off, the camera bases focus on the central area. (One playback mode displays a focus-area overlay, and shows which focus area was chosen for each image, by highlighting the appropriate set of marks in green. - This last function wasn't yet operational on our test unit.) Overall, the 990's focusing system is by far the most sophisticated we've seen on any digicam to date

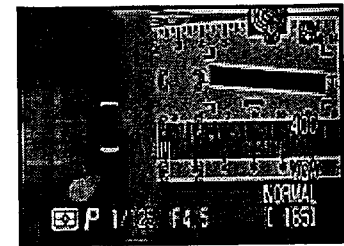
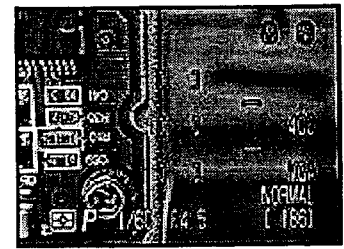

The lens itself has the same filter threads as the preceding Coolpix models, which accommodate Nikkor accessory lenses for wide-angle, telephoto, macro and fisheye focal lengths. Once a lens is attached, you'll need to select the corresponding lens type in the lens settings menu, shown at right. (The camera adjusts its operation for different lens types by restricting the zoom range to avoid vignetting, switching to center-weighted metering for the fisheye adapter, etc.) A digital telephoto feature can be turned off and on through the Zoom option under the Settings menu, enlarging images up to 4x. The 990's digital zoom is different from most in that it provides a smoothly-varying range of magnifications. An indicator on the LCD monitor displays the range of digital zoom at each step (from 1.1x to 4.0x). Like this feature on most digicams, digital telephoto on the Coolpix 990 enlarges the center of the image, resulting in reduced resolution and more artifacts as more digital zoom is used. The camera automatically switches to center-weighted metering and a center autofocus target when digital zoom is active. Also under the Zoom option, you can set the startup position of the lens (either wide or telephoto) and activate the Fixed Aperture function, which keeps the aperture fixed as the lens zooms. The startup position option was another highly-requested feature among '950 users, and can really save precious seconds in fast shooting situations. Likewise, the fixed-aperture zoom option is very useful when working with external flash units, to avoid varying the exposure as a function of lens focal length.

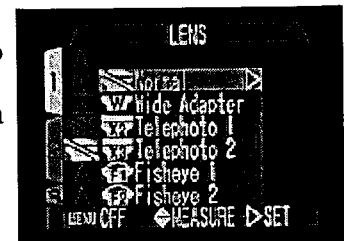

Exposure

Sophisticated, accurate exposure control has been a hallmark of Nikon cameras, both in the film-based and digital realms. The Coolpix 990's exposure system incorporates several enhancements over that of previous models, through the addition of a 7-blade lens aperture, and a 256-element matrix white balance system. Losing no ground in the process, the 256-element matrix exposure metering system of the Coolpix 950 has been retained.

The 990 offers very flexible exposure control, with Program, Flexible Program, Aperture Priority, Shutter Priority and full Manual modes to choose from when set to the Manual exposure mode on the Power/Mode dial. Although it took a little figuring out at first (due in part to the fact that our evaluation model was a prototype and without a manual), we eventually discovered that changing modes and exposure features could be done quickly and painlessly without having to rely on the LCD monitor. The combination of the command dial and the control buttons gave complete access to most of the normal exposure functions. We also enjoyed the variety of Manual exposure mode settings. The main difference

White Balance

The Coolpix 990 offers a lot of flexibility in its white balance settings, with a matrix-based Auto setting as well as Fine (Outdoors), Incandescent, Fluorescent, Cloudy, Speedlight (flash balanced) and Preset (or Manual). We were able to get reliable results with the Auto and Fine settings, although we attempted Preset and had varying results (it's highly possible that this feature was not yet functional on our prototype test unit). Particularly interesting is the ability to "fine tune" the white balance setting in all modes except Auto or Preset. We've frequently found the various white balance options on digital cameras to produce images with an overall warm or cool color cast, depending on the manufacturer's biases, the current lighting conditions, etc. On the 990, Nikon gives you the option of tweaking the white balance to your own preferences. When you access the white balance sub-menu and select a white balance option, rotating the command dial will adjust the white balance up or down over a range of +/- 3 arbitrary units. Positive adjustments shift the color toward bluish hues, while negative adjustments move it toward warmer tones. (In the screen shot above, we've adjusted the incandescent white balance up by 2 units.)

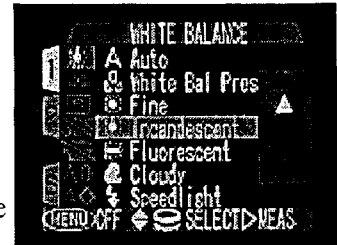

Metering Options

The Coolpix 990 also offers several metering options, with 256 segment Matrix metering (intelligently examining 256 segments across the entire image), Center-Weighted, Spot and Spot AF Area. This last is another option that's entirely unique to the Coolpix 990 (February 2000). Taking advantage of the multi-spot autofocus capability, Spot AF Area exposure setting determines exposure based on a spot reading centered on the location designated as the autofocus target under the Focus Options menu.

Other Features

We liked the fact that you can save up to three sets of user settings for focus, exposure, and other camera options, which can be a real time saver in rapidly switching between widely different sets of options. We also greatly appreciated the programmable Function buttons, which were designed to allow one handed operation of the camera. (These normally control exposure mode and exposure compensation, but can be reprogrammed to control macro/manual focus, flash settings, white balance, or metering options.) An Auto Bracketing feature brackets five steps (two above and two below) the set exposure value while the (amazing) Best Shot Select (BSS) takes several images and allows the camera to choose only the sharpest (least blurred) to be saved. Best Shot Select makes it feasible to hand-hold the camera for surprisingly long exposures. You can also check your own work immediately as the camera gives you a quick preview of the captured image (when shooting with the LCD monitor) and gives you an option to delete or save the image (this function can be turned off through the Setup menu, under Monitor Options).

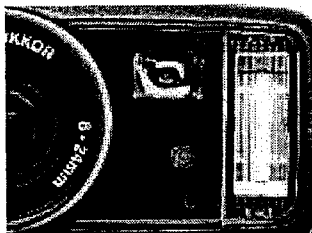

Flash Exposure

The Coolpix 990's built-in five mode flash (Auto, On, Off, Red-Eye Reduction and Slow-Sync settings) gives you a lot of flexibility: Through the settings menu, you can adjust the flash power from -2 to +2 EV units (!), as well as completely deactivate it. The Slow-Sync option is useful when shooting subjects with dark backgrounds (such as night scenes) because the camera actually leaves the shutter open longer and then fires the flash before the shutter closes. This lets a good amount of ambient light in and can be used to get a nice motion-blur effect. The "Red-Eye Reduction" mode fires a pre-flash before the main exposure, to try to get people's eyes to "stop down", reducing the internal reflection from the back of their eyeballs. Unfortunately, this is one of the real weaknesses of the 990's flash system (and the 950 too): The flash tube is so close to the lens (as seen in the photo above) that there's essentially no way you aren't going to end up getting red-eye, regardless of how much you get people's pupils to constrict. While an external flash will avoid this, it's a shame to need one to achieve good results on basic

people-pictures. Keep in mind that the flash is automatically switched off when shooting in the Infinity focus mode; the Continuous, 16 Shots or VGA Sequence modes; when using the Best Shot Selector; using a lens converter; or when the AE Lock option is on. An external sync socket means you can connect a more powerful external flash, and the camera allows both external and internal flashes to work together. (The socket connects to Nikon Speedlight models SB-28, 28DX, 26, 25, 24 and 22.) If the 990's internal flash is anything like that of its predecessors', we should be extremely pleased with its performance. One puzzling note: The preliminary documentation we received from Nikon was self-contradictory, in it stated the flash's range as 2 meters (6.6 feet) in telephoto mode, but also gave it a guide number rating of 9/30 (m/ft). In our own tests, the flash worked fine out to a distance of 14 feet, the limit imposed by the dimensions of our test studio.

Continuous Shooting Mode

The Coolpix 990 offers several "motor drive" rapid-exposure modes for capturing quick sequences of images. Our information here is a little sketchy, as the modes on the prototype unit we tested didn't match those in the (equally prototype) documentation we received. Production cameras may behave quite differently than our prototype unit did. Our understanding of the production features is listed in the table at the end of this review section. The documentation showed five modes (Continuous, Multi-Shot 16, Ultra High-Speed Continuous, VGA Sequence and Movie), all selectable under the Continuous option of the settings menu. Our test unit didn't have the Ultra High-Speed setting, but had instead an option named "9 Shot Frame". (We're told that the 9 Shot Frame function may not be on the production cameras.) Several of the Continuous-mode options on our test unit appeared to be mis-labeled, so we'll just describe them using the names from the documentation, ignoring the spurious "9 Shot Frame" label.

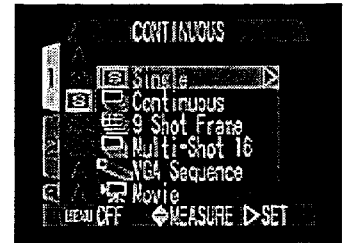

The Continuous mode captures frames very quickly, at whatever resolution and image quality the user has selected. We measured continuous-mode frame rates at approximately 1.0 frames per second at full resolution (3 frames maximum in a sequence), 1.62 frames per second for a maximum of 8 frames at XGA resolution, and 1.72 frames per second for a maximum of 21 frames in VGA mode. We're not sure where the 9 Shot Frame mode's name came from: Probably due to a firmware bug, it actually did what we expected the Multi-Shot 16 mode to do: It subdivided the image area into 16 sections and captured a "mini-movie" of small images (400 x 300 resolution), which filled-in a 4x4 array within a single high-resolution image as the shooting progressed, at a rate of 2.0 frames per second on our prototype unit. The mode labeled "Multi-Shot 16" on our test unit actually captured a long series of VGA-resolution images at 1.76 frames per second. Depending on the subject characteristics (e.g., how well it would JPEG-compress), it captured 40-50 pictures at a time. (We imagine this will be the production "VGA Sequence" mode.)

The VGA Sequence captures a sequence of VGA-resolution frames, stored as separate files on the CF card, also at a very quick rate. (Maximum sequence length and capture speed are dependent on image information and available CF card space.) New to the 990 is the Ultra High-Speed Continuous mode, which captures approximately 30 frames per second, totaling about 80 QVGA-sized images (320x240 pixels). Finally, the Movie mode is another new feature for the 990 model. Movie mode captures up to 40 seconds of moving images without sound at approximately 15 frames per second (QVGA size). Movie mode worked quite well on our prototype model, especially when combined with the swiveling lens design (we could run the camera and swivel the lens back on ourselves to get into the picture).

Shutter Lag/Cycle Times

When you press the shutter release on a camera, there's usually a lag time before the shutter actually fires. This time is to allow the autofocus and autoexposure mechanisms time to do their work, and can amount to a fairly long delay in some situations. Since this number is almost never reported on, and can significantly affect the picture taking experience, we now routinely measure it, using an electronic test system accurate to 0.01 seconds.

The Coolpix 990 autofocus speed is about average, compared to other digicams we've tested (January, 2000), with a shutter lag of 1.13 seconds in full autofocus mode, 0.18 seconds when the lens is

prefocused by half-pressing the shutter button, and 0.49 seconds in manual-focus mode. NOTE: Reader Bryan Biggers wrote in to report that a number of 990 owners have consistently measured shutter lag times of under 0.1 seconds in manual-focus mode. Unfortunately, we had already sent our test unit back to Nikon by the time we heard this, so couldn't repeat the test. We're pretty confident of our result though, since we (a) use an electronic test system that really couldn't produce an error of that magnitude, and (b) repeated this particular test several times, since we ourselves were surprised that the manual-focus delay was so long. We stand behind the number we measured, but given Bryan and others' experience, it's entirely possible that a modification was made in later production units. We tested a production model, but obviously one of the first off the line. A firmware change could easily account for this discrepancy. Thanks for the note, Bryan!

Shot to shot cycle time is very good though, at only 1.7 seconds for the first two shots in highest-quality JPEG mode, at which point the buffer memory is full and you have to wait something on the order of 7 seconds or so for it to empty. Lower resolutions increase the number of shots you can take in quick succession, and reduce the amount of time you need to wait for the buffer to clear again. At XGA resolution, you can shoot 7 frames at 1.62 second intervals, after which the next two frames will require 3 seconds each. If you continue shooting at maximum speed, the cycle time will alternate between 1.65 and 3.0 seconds indefinitely. We never found a maximum number of frames that filled the buffer in VGA mode, but it's something over 20. Cycle time in VGA mode was 1.65 seconds. (Note that all these cycle times were measured in manual focus mode: Autofocus mode would add about 0.6 seconds to the cycle times, to allow for focus-system operation.

Frame rates in continuous mode also varied as a function of resolution (albeit only slightly), as did the number of exposures we could capture before waiting for the buffer to empty. In high resolution mode, we could capture 3 frames at roughly 1 frame per second. At XGA resolution, we captured 8 frames at 1.62 frames per second. At VGA resolution, we captured 21 frames at 1.72 frames per second. The "VGA Sequence" option captured 40 frames at a rate of 1.76 frames per second. The 16-shot mode captured 16 quarter-resolution frames at a frame rate of 2.0 fps. Ultra high speed mode captured 80 320 x 240 frames at 30 fps (saving the results as individual image files in memory), while the Movie mode also captured 320x240 frames at 30 fps, with the resulting motion sequence saved in a single MOV file. The table below summarizes our cycle-time measurements:

Capture Mode	Interval/ fps	No. of frames
Single-shot, 2048x1536	1.76 sec	2
Single-shot, 1024x768	1.62 sec	7
Single-shot, 640x480	1.65 sec	>20
Continuous Mode, 2048x1536	1.0 fps	3
Continuous Mode, 1024x768	1.62 fps	8
Continuous Mode, 640x480	1.72 fps	21
VGA Sequence	1.76 fps	40
16-Shot Mode (512x328)	2.0 fps	16
Ultra High-Speed Mode (320x240)	30 fps	80
Movie Mode	30 fps	40 secs (w/incl 16MB card)

Operation and User Interface

As with the previous 950 model, we greatly appreciated the ease of the user interface on the Coolpix 990. The 950's interface was great, but the 990 goes quite a bit beyond it, making for what we feel is the best user experience in the industry. The LCD menu system is available for novices, or for less commonly-used controls, but experienced users will find they can make virtually all the most necessary adjustments without resorting to the LCD screen. Once you learn where the functions are, operation is quick and intuitive, thanks to the multiple control buttons and the excellent use Nikon makes of the black/white LCD readout. The inclusion of programmable Function keys simplifies operation even more, letting you assign common combinations of settings to a single key. Exposure compensation, exposure mode, ISO value, image quality and size, as well as focus controls (manual focus setting, macro, and infinity focus) and flash mode, can all be adjusted without the LCD. The small topside status display panel provides feedback for all these settings in a very clear fashion. When you do have to delve into the (very extensive) LCD menu system, navigation via the rocker toggle is easy, intuitive, and very rapid. In Record mode, the menu system is split into 3 pages of options(!), and a nice touch is the tabbed interface, by which you can jump between pages with only a few clicks of the rocker toggle, rather than having to scroll through every option to get to one buried on the second or third screen. Most of the camera's functions are controlled by a combination of hitting a button and turning the command dial. Functions that are accessed in this manner are delineated on the camera body with a very light purple lettering. This system makes it extremely fast and efficient to change settings without eating up too much battery power by using the LCD menu system. Control layout is also very logical, allowing one-handed operation for commonly-changed functions, requiring a two-handed approach only for manual focus setting, ISO, flash mode, and size/quality adjustment.

Control Enumeration

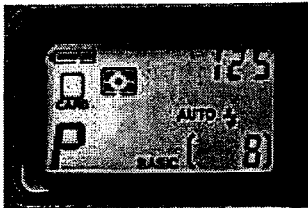

LCD Data Readout: Located on top of the camera, this readout displays status of a wide range of camera functions. More importantly, as noted above, you can manipulate and set most of these functions by using the camera controls and readout display together, letting you avoid the LCD menu system. This both saves power, and makes the camera functions much faster to navigate.

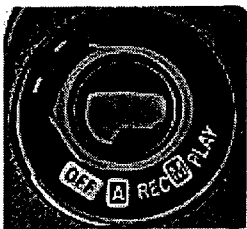

Shutter Button: Located on top of the camera and encircled by the Power/Mode dial, this button sets focus and exposure when halfway pressed and fires the shutter when fully pressed.

Power/Mode Dial: Also located on the top panel of the camera, surrounding the shutter button, this dial selects between Off, Auto Record, Manual Record and Play modes.



Mode/Func.1 Button: Located on the top panel, this button selects the exposure system mode (Program,

Flexible Program, Shutter Priority, Aperture Priority and Manual) when held down while turning the command dial with the camera in Manual record mode. This button can also be programmed through the Setup menu to access various exposure functions with a single button actuation.



+/- / Func.2 Button: Located directly to the right of the Mode button, this adjusts the amount of exposure compensation (from -2 to +2 EV in 1/3 EV steps) when held down while turning the command dial. This button can also be programmed through the Setup menu to access various exposure functions.



Command Dial: Located on the top right of the camera, this dial is used in conjunction with various controls in Record mode to adjust exposure options. In Play mode, the dial cycles through the five information pages associated with each captured image, giving the user an unparalleled amount of information about the exposure (image information page, camera firmware page, image adjustment page, exposure histogram and focus confirmation).



Monitor Button: Located on the top of the rear panel of the camera, this button recalls or cancels the color LCD screen information display and viewfinder.



Menu Button: Located directly to the right of the Monitor button, this button pulls up the settings menu in all capture modes as well as in Play mode. Pressing it again cancels the menu.



W and T Buttons: Located further to the right from the Menu button, these buttons control the optical zoom in all capture modes. Likewise, when the digital telephoto option is enabled, these buttons control the amount of digital zoom (from 1.1x to 4.0x). In single-image playback mode, pressing the "T" button repeatedly zooms in on the image (you can scroll around in the zoomed image by using the rocker toggle control). Pressing the "W" button cancels zoomed playback.



Rocker Toggle Control: Located on the right side of the LCD monitor, this button features four arrows that allow the user to navigate through the LCD menu system and make selections in Record and Play modes. We found menu navigation on the Coolpix 990 particularly straightforward, in that all menu actions are taken via the rocker toggle: There's no need to confirm a selection by pressing a different

button. Different menu items are selected via the up/down arrows on the toggle control. Pressing the right arrow selects that item, generally taking you into a sub-menu. Pressing the left arrow takes you back out again. Once in a sub-menu, the up/down arrows again step between items, while a right-arrow selects. This process continues until you arrive at the final point of selection, upon which another right-arrow actuation makes that selection and returns you to the main menu. We were also pleased to see that we could left-arrow from the initial screen, to go to a set of tabs that let you quickly jump from menu screen one to two, or to the setup screen very quickly, without scrolling through all the menu entries first. All this takes much longer to describe than do: The 990's menu design and use of the rocker toggle made it by far the quickest system to navigate we've seen yet.

In Play mode, the right and left buttons scroll through captured images one at a time. As noted above, in zoomed playback mode, this control lets you scroll around within the enlarged image.



Manual Focus/Macro Button: Located directly beneath the LCD display, on the left side, this button has several functions. When held down while turning the command dial, this button controls the manual focus option in Record mode. Also in Record mode, this button (when pressed on its own) cycles through Infinity focus, Macro and Self-Timer modes. In Play mode, this button acts as the Delete command for the currently displayed image (designated by the trash can symbol). In a welcome addition, Macro and Self-Timer modes can be used at the same time, even though they're controlled by the same button. (As you cycle through the modes accessible with this button, one mode has both macro and the self-timer enabled simultaneously.)



Flash/ISO Button: Centered under the LCD panel, this button cycles through the flash modes (Auto, On, Off, Red-Eye Reduction and Slow-Sync). In Manual Record mode, this button cycles through the variable ISO settings (Auto, 100, 200 and dEF). In Play mode, this button pulls up a four or nine image index display of all captured images.



Quality/Size Button: Located directly to the right of the Flash button, this button cycles between image quality options (Basic, Normal, Fine and Hi) in all record modes. In any record mode, this button also cycles through the image size settings (3:2 2048 x 1360, VGA 640 x 480, XGA 1024 x 768 and 2048 x 1536) when held down while turning the command dial. In playback mode, if the currently-selected picture is a movie sequence, this button initiates playback of it.



Dioptic Adjustment Dial: Located directly beneath the optical viewfinder (on the underside of the lens half of the case), this small, black dial adjusts the viewfinder to accommodate eyeglass wearers.

Camera Modes and Menus

Automatic Record Mode: Accessed by turning the Power/Mode dial to the "A" setting, this mode puts the camera in charge of exposure and focus, but still leaves settings like flash, exposure compensation, size, quality and the self-timer under the user's control. Pressing the Menu button in this mode pulls up the following Setup menu:

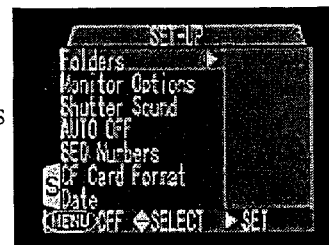

- **Folders:** pulls up a sub-menu that allows users to create, delete and rename image storage folders in separate groups (much like the 950). This also allows users to select which folder images will be saved to.
- **Monitor Options:** pulls up a sub-menu that allows users to adjust the brightness and hue of the LCD monitor display.
- **Shutter Sound:** turns the shutter sound on or off.
- **Auto Off:** allows users to set the auto-off delay to 30 seconds, one minute, five minutes or 30 minutes.
- **Seq. Numbers:** turns the file numbering sequence on or off as well as resets the current sequence.
- **Card Format:** Formats the CompactFlash card and erases all folders and images.
- **Date:** sets the camera's internal date and time.

Manual Record Mode: Accessed by turning the Power/Mode dial to the "M" setting, this mode offers several options for manually controlling exposure (Program, Flexible Program, Aperture Priority, Shutter Priority and Manual). Program puts the camera in charge of aperture and shutter speed, while the user can control things like white balance, motor drive, etc. Flexible does the same, but allows the user to select between various combinations of shutter speed and aperture settings. Aperture and Shutter Priority put the user in charge of either the aperture or shutter speed while the camera controls the other value. And finally, Manual lets the user control both aperture and shutter speed, independent of the camera's exposure system. All of these capture modes are accessible by pressing the Mode button and turning the command dial until the desired mode appears on the status display. Pressing the Menu button in this mode pulls up the following settings menus:

Screen One

- **White Balance:** pulls up a sub-menu with seven white balance options: Auto, White Balance Preset, Fine (Outdoors), Incandescent, Fluorescent, Cloudy and Speedlight (flash balanced).
- **Metering:** offers 256 Segment Matrix, Center-Weighted, Spot and Spot AF Area metering options.
- **Continuous:** offers six "motor-drive" options: Single exposure, Continuous Shooting, Multi-Shot 16, VGA Sequence, Ultra-High Speed, and Movie.
- **BSS:** turns the Best Shot Selector function on or off.
- **Lens:** lets the user select between Normal (built-in lens), Wide Adapter, Telephoto 1 (a 2x adapter), Telephoto 2 (a 3x adapter), Fisheye 1 and Fisheye 2 options to accommodate the specified accessory lens. As noted in the main review, the different options adjust various exposure and zoom setting options to best accommodate the chosen lens.
- **Image Adjust:** allows the user to further alter the image with options of Auto, Normal, More Contrast, Less Contrast, Lighten Image, Darken Image and Black & White. (See discussion under Exposure section of the review, above.)
- **Image Sharpening:** adjusts the in-camera sharpening to Auto, High, Normal, Low or Off.)

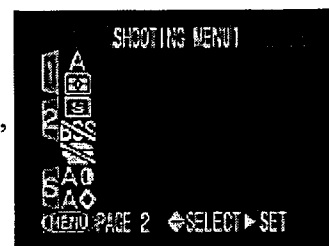

Screen Two

- **User Setting:** allows the user to save up to three different sets of user settings to be recalled at any given time (useful for quickly switching between groups of settings for different shooting scenarios).
- **Exposure Options:** allows the user to turn the AE Lock and Auto Bracketing on or off as well as adjust the exposure compensation. (While exposure compensation can be set from this menu entry, you would more commonly do so via the top-panel +/- button and function wheel.)
- **Focus Options:** selects between AF Area Modes (Auto, tracking/manual/center, or off), Autofocus Modes (Continuous or Single AF), Peaking (On, Off, Manual Focus only), and Distance Units (feet/meters) focusing modes.
- **Zoom Options:** allows the user to activate the digital telephoto, designate the startup position (wide, telephoto, or the last-used position, a feature we found particularly welcome). Also lets you select the Fixed Aperture option, which keeps the aperture fixed as the lens zooms. (This last useful for flash photography, with external strobe units.)
- **Speedlight Option:** allows the user to adjust the flash intensity (+/- 2EV unit range in 1/3 EV steps) and set up the internal and/or external speedlight options (both active or internal flash off).
- **Reset All:** resets all the menu options to factory defaults (it thankfully does give you an option to back out if you decide you want to).

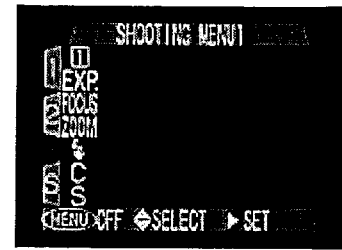

Setup Screen

- **Folders:** pulls up a sub-menu that lets users create, delete and rename image storage folders in separate groups (much like the 950). This also lets users select which folder images will be saved to.
- **Monitor Options:** pulls up a sub-menu that allows users to adjust the brightness and hue of the LCD monitor display.
- **Shutter Sound:** turns the shutter sound on or off.
- **Controls:** allows the user to program the Function 1 and 2 buttons (Mode and +/- buttons) to set up specific exposure functions. (VERY handy!)
- **Auto Off:** allows users to set the auto-off delay to 30 seconds, one minute, five minutes or 30 minutes.
- **Seq. Numbers:** turns the file numbering sequence option on or off as well as resets the current sequence.
- **Card Format:** Formats the CompactFlash card and erases all folders and images.
- **LED Shot Confirm:** turns the shot confirmation light on and off. (This is a small orange LED on the front of the lens housing that illuminates briefly after the shutter trips, as an indication that the shot has been taken. Useful for self-timer shots taken without flash.)
- **Date:** sets the camera's internal date and time.
- **Video Mode:** sets the video format to NTSC or PAL.
- **Language:** sets the camera language to German, English, French or Japanese.

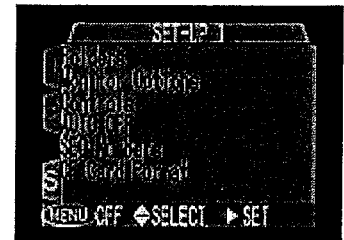

Play Mode: Accessed by turning the Power/Mode dial to the Play position, this mode allows users to view captured images and movies. The right and left arrow buttons scroll through images while the Delete and Index Display buttons (beneath the LCD panel) offer quick image deletion and display. Pressing the Menu button in this mode pulls up the Play settings menu:

Screen One

- **Delete:** lets the user delete a Selected Image, All Images, Erase Folder or Print Set. (A "Print Set" refers to the set of images currently marked for printing, using the DPOF (Digital Print Order Format))
- **Folders:** allows the user to create, delete or rename folders as well as select the playback folder from a list.
- **Slide Show:** starts a slide show playback of all images in a folder and allows the user to set the frame interval.
- **Protect:** allows the user to select individual images for write protection.
- **Hide Image:** allows users to hide selected images from view.
- **Print Set:** allows users to select individual images and mark them on the memory card for subsequent printing by a standalone printer. (This uses the standard Digital Print Order Format (DPOF) protocol.)

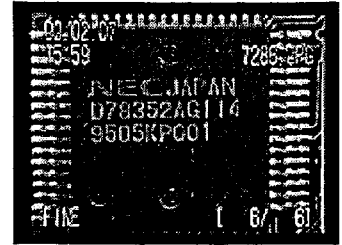

Setup Screen

- **Monitor Options:** pulls up a sub-menu that allows users to adjust the brightness and hue of the LCD monitor display.
- **Shutter Sound:** turns the shutter sound on or off.
- **Auto Off:** allows users to set the auto-off delay to 30 seconds, one minute, five minutes or 30 minutes.
- **Seq. Numbers:** turns the file numbering sequence option on or off as well as resets the current sequence.
- **CF Card Format:** Formats the CompactFlash card and erases all folders and images.
- **LED Shot Confirm:** turns the shot confirmation function on and off.
- **Date:** sets the camera's internal date and time.
- **Video Out:** sets the video format to NTSC or PAL.
- **Language:** sets the camera language to German, English, French or Japanese.

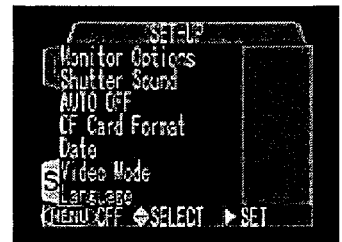

Image Storage and Interface

Like the 950 and the 900 before it, the Coolpix 990 uses CompactFlash memory cards for image storage, shipping with a 16 MB card. We suspect that most users will almost immediately want to purchase a larger card though, as 64 MB cards have become quite reasonable in price, and cards as large as 128 MB are currently available (February, 2000). We were glad to find the new location of the CompactFlash slot in the hand grip (the 950 model's slot was on the bottom of the camera, making it difficult to change cards while mounted to a tripod). The 990 also has a very nice, functional cover door for the CF card slot, a huge improvement over the 950's less-substantial arrangement.) The 990 includes several subtle niceties that make life a little easier, including a folder arrangement that allows users to organize images in the camera, a sequential frame counter option to avoid problems with overwriting files when copying them to your computer, some powerful in-camera tonal adjustment controls and the much appreciated Best Shot Selector option that automatically chooses the least blurry image, when shooting under difficult conditions.

Captured images can be individually write protected through the Play mode settings menu. Write protected files are only immune to accidental deletion, not card reformatting. File formats include several levels of compressed JPEG files as well as an uncompressed TIFF mode (Hi quality setting).

<i>Resolution/Quality vs Image Capacity</i> (Included 16MB card)	Full Resolution		XGA Resolution		VGA Resolution	
	Images	Approx. Compression	Images	Approx. Compression	Images	Approx. Compression
Uncompressed	1	1:1	-	-	-	-
Fine Quality	10	6:1	40	6:1	100	6:1
Normal Quality	20	12:1	79	12:1	187	12:1
Basic Quality	40	20:1	150	20:1	332	20:1

Video Out

One significant difference between the Coolpix 990 and its predecessors is that there now appears to be only a single international version of the camera, supporting either NTSC or PAL standards. The US version of the Coolpix 990 includes a video out jack and connection cable, defaulting NTSC-formatted video output. European models will doubtless support PAL timing and connections. You can switch between NTSC or PAL timing through a setting in the Setup menu. Connecting the video output provides a signal to an external device, without disabling the internal LCD display screen. All images that would normally appear on the LCD are also routed to the external video display so that the television screen becomes an enlarged version of the LCD monitor and can be used both for image playback and composition.

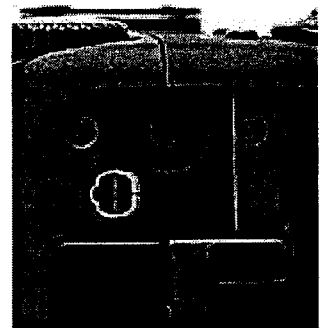

Power

The Coolpix 990 runs on four AA batteries, housed inside the hand grip, or an external AC adapter which plugs into the front of the camera. Nikon estimates about 1.5 hours of operating time when using the LCD monitor and four 1.5V LR6 (alkaline AA L40) batteries at a normal temperature of 68 degrees Fahrenheit. (We find this a trifle optimistic.) In our own tests, the Coolpix 990 prototype consumed about as much power as typical 2 megapixel digicams, despite the larger sensor and large SDRAM buffer memory. As always, we highly recommend keeping a couple sets of freshly charged rechargeable NiMH cells nearby. We should note here that the ability to switch the autofocus mode from Continuous to Single saves significant battery power. Enormous power savings are possible if you leave the LCD monitor off, and rely on the small top-panel readout when adjusting camera settings. Power consumption with the LCD screen turned off was very low indeed: You could easily run all day on a single set of batteries in this mode.

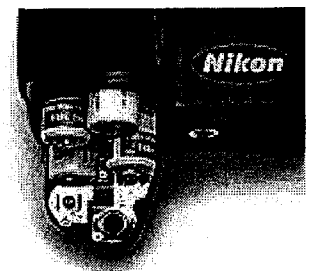

Operating Mode	Power Drain
Capture Mode, w/LCD	580 mA
Capture Mode, no LCD	< 10 mA
Half-pressed shutter w/LCD	570 mA
Half-pressed w/o LCD	340 mA
Capture Mode, Continuous AF	640 mA
Memory Write (transient)	580 mA
Flash Recharge (transient)	1000 mA
Image Playback	370 mA

Included Software

As of this writing, Nikon had not yet finalized the software bundle for the 990. We'll update accordingly as the information becomes available.

Test Results

In keeping with our standard policy, our comments here are rather condensed, summarizing our key findings: For a full commentary on each of the test images, see the [Coolpix 990's "pictures" page](#).

As with all Imaging Resource camera tests, we encourage you to let your own eyes be the judge of how well the devices performed: Explore the images on the [pictures page](#), to see how well the Coolpix 990 performed, and how its images compare to other cameras you may be considering buying.

The first thing that struck us about the Coolpix 990 was how **sharp** its pictures were! The earlier Coolpix 950 showed excellent sharpness and detail, but the 990 clearly raises this performance to a new level. Resolution was the best we've seen out of the digicams we've tested to date (early March, 2000), although in fairness, we have a number of 3 megapixel models yet to go. We "called" the 990's resolution at 800-850 lines per picture height in both horizontal and vertical directions, with significant detail visible all the way out to 900-1000 lines. By comparison, the 950 tested out at about 800 lines horizontally (and a bit of a stretch at that), and 650-700 vertically. Overall, a significant step up in resolution, much more than we saw in digicams when going from the 1.5 to 2.1 megapixel level. (These numbers were obtained with the lens at its wide angle setting: Telephoto numbers were slightly lower, as is usually the case.)

Color was very good as well, with excellent saturation across the spectrum. The only weaknesses we could find were a slight tendency to undersaturation in bright yellow hues, and the (very common) problem with the tricky blues in the model's pants and flowers in the outdoor shots. (For whatever reason, many digicams tend to produce rather purplish hues in these colors, and the 990 fell prey to that tendency somewhat as well.) Overall color was very good though.

True to its heritage from Nikon's high-end film cameras, exposure accuracy and control were excellent in the 990. Nikon's apparently added a matrix-evaluating white balance function to the 990, making its auto white balance algorithm a bit more sure-footed. For really tough lighting situations though, we still found ourselves using the manual preset white balance option, a feature we **really** like to see in digicams we test. (Note to other high-end digicam manufacturers: This is a "must-have" feature for high-end prosumer cameras!) The addition of a true iris-based aperture in the 990 was a significant improvement over the 950's three-aperture system, and very welcome.

In our low-light tests, the Coolpix 990 did exceptionally well, producing usable but dark images in light levels as low as 1/16 of a foot-candle, and very usable ones at levels of 1/8 of a foot-candle. Noise was

also quite low (camera was stabilized at a temperature of 70 degrees F (~21C) for these shots). For comparison, a well-lit city scene under typical modern street lighting corresponds to a level of about 1 foot-candle. The Coolpix 990 is a great low-light shooter!

As is the case with most digicams, the Coolpix 990's optical viewfinder shows less of the subject than the final image does, displaying a fairly typical 86% of the final area in wide angle and 88% in telephoto mode. The LCD viewfinder was almost 100% accurate though, a very welcome feature for shots involving critical framing (as so many of our test shots do).

Like the '950 before it, the Coolpix 990 is a spectacular macro performer, with a minimum area coverage of only 0.78 x 0.58 inches (19.69 x 14.77 mm). Combined with the 990's 3 megapixel resolution, the detail it can record is literally microscopic!

At the bottom line, the Coolpix 990 delivers a solid upgrade in image quality and resolution relative to the already-excellent Coolpix 950, with some of the best detail and sharpness we've seen yet in a digicam. (At least, as of early March, 2000.)

Conclusion

The Coolpix 990 is an exceptional follow-on to the already excellent Coolpix 950. The list of added features, options, and capabilities is too long to include in a brief conclusion, but suffice to say they're both extensive and eminently useful. Virtually every aspect of the camera's performance has been enhanced or extended, and the result is a true 3 megapixel powerhouse. Despite its incredible array of features though, its fully-automatic Auto record mode makes it easy enough for even the rankest amateur to use. (Set it in "Auto" mode, and hand it to your spouse with no worries or explanations.) For power users, the 990 sports one of the best-designed user interfaces we've had the pleasure to work with. Nikon clearly listened to users of the Coolpix 900 and 950 in developing the 990, and the results show: We're confident in predicting that this will be a very popular digicam, among both amateurs and professionals!

Reader Comments!

See what other Imaging Resource readers have had to say about the Coolpix 990, or add comments of your own. (*Read what's here, then add your own!*)

For even more feedback, read the [User Reviews from PCPhotoREVIEW](#)

Reader Sample Images!

Do you have a Nikon Coolpix 990 camera? If you'll post an album of your samples that we can point to with a single URL (not all services permit this, some require you visit the main site and type a name and password) and email us at web@imaging-resource.com, we'll list the album here for others to see!

- [Sample pictures from PCPhotoREVIEW readers](#)
- [Chris Arellano's CoolPix 990 album](#) (Here's Chris's...where's yours?)
- [Steve Schnoor's Sample Images](#)
- [Rex Steyskal's Sample Images](#) - Very nice pictures taken at the Detroit Zoo! Also, if you go to his main album page, you can find tons of pictures for the CoolPix 950 album. Not what you were interested in, if you're visiting this page, but definitely worth taking a look!

For More Info:

View the [Coolpix 990 Sample Pictures Page](#)

View the Imaging Resource Data Sheet for the Coolpix 990

Visit the Comparometer(tm) to compare with other cameras.

Visit the Nikon home page for the Coolpix 990

Back to the Imaging Resource Digital Cameras Page

Or, Return to the Imaging Resource home page.

This document copyright (c) 2000, The Imaging Resource, all rights reserved. Visitors to this site may download this document for *local, private, non-commercial use*. Individuals who have *themselves* downloaded this page may print a copy on their personal printers for convenience of reading and reference. Other than this explicit usage, it may not be published, reproduced, or distributed in print or electronic and/or digital media without the express written consent of The Imaging Resource.