



IVIEWIT HOLDINGS, INC.

P. Stephen Lamont
Chief Executive Officer
Direct Dial: 914-217-0038

July 2, 2003

By Overnight Delivery

Thomas J. Cahill, Esq.
Chief Counsel
First Judicial Department Departmental Disciplinary Committee
61 Broadway, 2nd Floor
New York, New York 10006

Re: **Rebuttal of Kenneth Rubenstein, Esq. Response to Complaint of Iviewit Holdings, Inc., Docket 2003.0531**

Dear Mr. Cahill:

By way of introduction, I am Chief Executive Officer (Acting) of Iviewit Holdings, Inc. and its subsidiaries (collectively, "Company") with a background of which the Company invites you to view at <http://www.iviewit.com/management.htm>, and I write to rebut all those material feints, denials, and, therefore, inconsistencies in the response of Kenneth Rubenstein, Esq. ("Respondent") to the Company's New York Bar Complaint of February 26 ("Complaint").

Moreover, the facts of the Complaint find Respondent so unclad that he resorts to disingenuously traversing from tall tales of retaliation to some irrelevant litigation, to stories of a "failed dotcom company looking for someone to blame," and even to the personal attacks on the founder and principal inventor of the Company, whose passion for his inventions confounds the mind of Respondent whose personal, financial, and other ambitions rise above all, to the detriment of his clients. Furthermore, Respondent continues this transparent discourse and all the while maintaining "The only thing I did for Iviewit is I referred them to another patent lawyer,"¹ which the Company shall incite in the minds of First Judicial Department Departmental Disciplinary Committee

¹ Deposition of Kenneth Rubenstein at 23, *Proskauer Rose LLP v. Iviewit.com, Inc. et. al. Case No. CA 01-04671 AB (Circuit Court of the 15th Judicial Circuit in and for Palm Beach County, Florida filed May 2, 2001)*, attached herein as [Exhibit A](#).



Thomas J. Cahill, Esq.
7/2/2003
Page 2

that such a statement by Respondent could not be farther from the truth, as evidenced by Section I to Section XII, *infra*.

Prior to Section I to Section XII, *infra*, however, the first feint we need to address, and as Respondent has chosen to apprise you, is that the Company and Respondent's employer, Proskauer Rose LLP ("Proskauer"), are parties to that certain litigation titled *Proskauer Rose LLP v. Iviewit.com, Inc. et. al., Case No. CA 01-04671 AB (Circuit Court of the 15th Judicial Circuit in and for Palm Beach County, Florida filed May 2, 2001)* ("Litigation") that, as Respondent is aware, yet prefaces and attributes the Complaint to said Litigation, bears not one iota of relevance to the specific allegations contained in the Company's Complaint.

Second, another important feint to correct, and wherein Respondent hopes that First Judicial Department Departmental Disciplinary Committee fails to see the forest from the trees, is that the Company is not now nor has ever been a so called "dotcom" company, but rather is a designer and developer of video scaling and imaging technologies where, in combination and among other things, said technologies have the capability of "panning and zooming" on any image or any image within a video without degradation to the quality of that image (where degradation is termed "pixelation" to those skilled in the art).

Additionally, the Company technologies are targeted to device original equipment manufacturers ("OEMs") who, when individually, or in combination with other third party hardware, firmware, and/or software, shall include them in OEM products such as, but not limited to, cable set top boxes, satellite set top boxes, analog-to-digital converter boxes, next generation DVD players, digital cameras, personal video recorders, and personal computers; alternatively the Company has the option of exclusively contributing said essential technologies to the multimedia patent pools known as MPEG 2 (digital compression according the digital television standard), MPEG 4 (another compression standard at a lower bit rate, and wherein interactive objects may be embedded), and DVD ("digital video disc") player-drive-codec and the discs themselves.

Third, and most disingenuously, Respondent attempts to point to the two and one half percent (2.5%) interest in, an interest that Proskauer paid a nominal, par value price for, and that was supposedly in return for adoption by the MPEG 2 patent pool of the Company's essential inventions, the Company's direct, 92.03% owned, subsidiary, Iviewit Technologies, Inc., that more specifically translates into a one and ninety nine one hundredths of a percent (1.99%) fully diluted interest in lower valued Class B Non-Voting shares of the Company's direct subsidiary, as a motivation for Proskauer to see the Company succeed, yet fails to apprise First Judicial Department Departmental Disciplinary Committee that in Respondent's stewardship of the MPEG 2 patent pool,



Thomas J. Cahill, Esq.

7/2/2003

Page 3

which presently generates royalties in the nine figures, according to industry observers, and that once digital television and the content therewith assumes a penetration rate in U.S. households akin to analog color television that said royalties from MPEG 2 shall rise into the trillions of dollars, and much to the benefit of Respondent in his role as counsel, by his admission², and to the best of the Company's knowledge, patent evaluator, and Proskauer, thereby dwarfing any potential realized gain from the nominally priced equity position in the Company's direct subsidiary. Clearly, by this analysis, the Company suggests that Respondent and his author, Steven C. Krane ("Author"), continue to apply their skills sets towards, physics and technology licensing, and legal ethics and dispute resolution, respectively, as their prospects of future careers as financial analysts have diminished as a result of this poorly attempted feint in the response of Respondent.

Fourth, and an equally poorly analyzed feint, is Respondent's reference to a letter presented in his deposition to that certain Litigation on November 20, 2002, wherein such Litigation is wholly irrelevant to the Complaint, but is instructive for these purposes, seemingly attempting to engage Respondent's services future services, but by viewing an electronic copy and right clicking the mouse of a IBM compatible personal computer and selecting "properties" it is clear to Respondent that said letter's date of creation was April 25, 2002, which was designed as a means for which to allow Respondent to "save his soul" by reaffirming prior statements to potential licensees, and inapposite to Respondent's assumed intention (see Section IX Subsection A and Exhibit O – Statement of CEO Lamont).

Lastly, Mr. Cahill, and as Respondent would have you believe, this is NOT the Complaint of Eliot I. Bernstein, but of Iviewit Holdings, Inc. (a Delaware Corporation) funded in total of approximately Six Million Dollars (\$6,000,000) by prominent investors and entertainment professionals alike, including, but not limited to: Wayne Huizenga, Wayne Huizenga Jr., Alan Epstein, Esq. and Michele Mulrooney, Esq. of Armstrong Hirsch Jackoway Tyerman & Wertheimer of Los Angeles. Cal., Kenneth Anderson, CPA, Donald Kane (formerly Managing Director of Goldman Sachs), James Osterling, James Armstrong, Ellen DeGenres, Alan Young, Allan Shapiro (Atlas Entertainment), Mitchell Welsch (Vice President of UBS Paine Webber), and Jeffrey Friedstein (Vice President of Goldman Sachs), Caroline P. Rogers, Esq. and many others.

Furthermore, the allegations in the Complaint stem from legal reviews by Irell and Manella of Beverly Hills, Cal, Blakely Sokoloff Taylor & Zafman LLP of Los Angeles, Cal., Caroline P. Rogers, Esq., the Chicago office of Greenberg Traurig LLP, Steven M. Selz, Esq., and by executives of Warner Bros., a unit of AOL Time Warner, Inc., who in the course of discussion both at the business level and personal level have advised that

² *Supra* Note 1 at 22.



Thomas J. Cahill, Esq.
7/2/2003
Page 4

looks can be deceiving when viewing the Company's patent applications filed by patent counsel under the supervision of Respondent, as the filings they viewed differ materially, and, perhaps, fraudulently, the Company alleges, from the teachings and disclosures of the Company's inventors, Mr. Bernstein, Zakirul Shirajee, and Jude Rosario, and to the detriment of the Company's filings.

Now, with the above clarified, the Company points straight to the heart of the matters, and despite Respondent's statements in his deposition, wherein such Litigation is wholly irrelevant to the Complaint, but is instructive for these purposes, and laughable statements at that, the Company alleges, that include but are not limited to, "The only thing I did for Iviewit is I referred them to another patent lawyer" and "I consider the deposition nothing but harassment, considering that I had nothing to do with the company³," and his denial of making any representations to any party with regard to the Company's technologies⁴, we summarily state that from the benefit of the narrative and attached exhibits below, the Company shall incite in the minds of First Judicial Department Departmental Disciplinary Committee that Respondent: (I) engaged in a series of dishonesties, appearances of untrustworthiness, conduct involving dishonesty, fraud, deceit, and misrepresentation with, and as the supervising attorney of, one Raymond A. Joao⁵ who at the time of Respondent's referral was in transition from places unknown, but later figuratively drops out of the sky, while misrepresented as a member of Proskauer, and as of February 1999, becomes of counsel to Meltzer, Lippe Goldstein & Schlissel LLP ("MLGS"), Respondent's former employer, in an attempt to bury the Company's inventions that are a competitive threat to the multimedia patent pools of which Respondent holds the position of counsel, by self admission, and, to the best of the Company's knowledge, patent evaluator; (II) engaged in a series of improprieties and deceptions with a one Christopher C. Wheeler⁷, a Partner in the Boca Raton office of Proskauer Rose LLP ("Proskauer") in a further attempt to deprive the Company of its technologies for the benefit of Respondent, Mr. Wheeler, and Proskauer by directing Mr. Wheeler to proliferate the Company's technologies across a wide array of clients of Respondent, Mr. Wheeler, and Proskauer, according to Non-Disclosure Agreements ("NDAs") never enforced by Mr. Wheeler, and a true list of clients conducting said unauthorized use is attached herein as [Exhibit D](#); (III) by virtue of his actions in (I)

³ *Supra* Note 1 at 12.

⁴ *Supra* Note 1 at 40.

⁵ First Judicial Department Departmental Disciplinary Committee should be apprised of the fact that the Company has filed, as it relates to Mr. Joao, a complaint with the New York State Bar Association wherein such complaint, response to said complaint, and the Company's rebuttal are attached herein as [Exhibit B](#).

⁶ *Supra* Note 2.

⁷ First Judicial Department Departmental Disciplinary Committee should be apprised of the fact that the Company has similarly filed, as it relates to Mr. Wheeler, a complaint with The Florida Bar Association wherein such complaint, response to said complaint, the Company's rebuttal to said complaint, Mr. Wheeler's second response, and the Company's second rebuttal are attached herein as [Exhibit C](#).



Thomas J. Cahill, Esq.
7/2/2003
Page 5

thereby perpetrating a fraud upon the United States Patent and Trademark Office (“USPTO”) in the supervision of Mr. Joao; and (IV) by virtue of (I) through (III) all to the detriment of the patent filings and present fortunes of the Company and its stakeholders alike.

Accordingly, on behalf of the Company, and for ease of reference I insert the major allegations of the Complaint within the framework of The Lawyer’s Code of Professional Responsibility of the New York State Bar Association,⁸ cross referencing Title 22 of New York Codes, Rules and Regulations⁹ (“NYCRR”), and shall cite specific documentation in exhibits attached hereto:

I. DR 1-102 [§1200.3] Misconduct.

The Company rebuts the feints, denials, and, therefore, inconsistencies in the response of Respondent and re-alleges that Respondent had, during the period of representation of the Company from 1998 to mid 2001, and irrespective of at which date, and in which form, an engagement agreement was executed by and between Proskauer and the Company: (I) engaged in illegal conduct that adversely reflected on Respondent’s honesty, trustworthiness, and fitness as an attorney; (II) circumvented a Disciplinary Rule through actions of another, Mr. Joao; (III) engaged in conduct involving dishonesty, fraud, deceit, or misrepresentation; and (IV) engaged in other conduct that adversely reflects on Respondent’s fitness as a lawyer.

Additionally, the Company, *interalia*, shall establish: (I) that Respondent, as the first technologist to benefit from the inventions disclosures by the Company, was seen by the inventors, executive management, investors, and potential licensees, as the individual responsible for the oversight of the Company’s patent prosecution process; (II) that Respondent used the referral of Mr. Joao as the cloaking device to bury the Company’s inventions that are competitive threats to the multimedia patent pools, thereby maintaining Respondent’s personal financial gains, esteem, and clients from the multimedia patent pools where Respondent, by admission, holds the position as counsel, and also, to the Company’s best knowledge, patent evaluator; (III) that Respondent opined as to the novelty of the Company’s inventions to investors and potential licensees at the same time he was directing Mr. Joao to bury the Company’s inventions in provisional patent filings that are a competitive threat to his patent pools and directing Mr. Wheeler to proliferate the Company’s technologies among clients of Respondent, Mr. Wheeler, and Proskauer without the enforcement of NDAs; and (IV) that Respondent engaged in other conduct that adversely reflects on Respondent’s fitness as a lawyer by his unconscionable speaking of falsehoods in a recent deposition in the Litigation, wherein such litigation is wholly irrelevant to the Complaint, but is instructive for these

⁸ Lawyer’s Code of Professional Responsibility, New York State Bar Association (January 1, 2002)

⁹ 22 New York Code, Rules and Regulations.



Thomas J. Cahill, Esq.
7/2/2003
Page 6

purposes, in which he denies, *interalia*: (a) knowledge of the Company, however, has been named as overseer of the Company's patent prosecution process and has been named as a member of the Company's Advisory Board and has opined as to the novelty of the Company's inventions to investors and potential licensees alike; (b) denies knowledge of the Company's main inventor, Mr. Bernstein, and other inventors, although he has spent many hours in disclosure sessions with the Company's inventors; and (c) has refused to describe his involvement with the organization MPEG LA, LCC that through doctrines of *respondeat superior* and vicarious liability may be liable for the actions of Respondent in other forums separate and apart from the Complaint, and where said speaking of falsehoods in (a) through (c) has been steadfastly repeated in Respondent's response to the Complaint.

A. More specifically, Respondent, when first apprised of the Company's technologies states, through Mr. Wheeler, the opinion that they are "novel" and a statement relied upon by early investors in the Company. Moreover, through and in conjunction with Mr. Wheeler, Respondent becomes fully aware of the Company's inventions whereby he receives invention processes, visits the proprietary pages of the Company's web site, receives proprietary and confidential CD-ROM's, is, factually, in constant phone contact with the Company's inventors to learn the Company's techniques, often times with Mr. Joao, and transmits examples of patents to Mr. Bernstein that point to the patent prosecution process he intends to oversee and undertake in conjunction with Mr. Joao, attached herein as [Exhibit E](#).

Moreover, once knowledgeable about the Company's inventions and in disclosure teleconferences with Mr. Bernstein, the Company finds Respondent muttering to himself "I missed that" and "we never thought of that" and "**THIS CHANGES EVERYTHING.**" Furthermore, when Respondent's muttering of "I missed that" and "we never thought of that," the Company alleges that Respondent is incensed at the thought of a self taught video engineer, the likes of Mr. Bernstein and his fellow inventors, formulating video and imaging processes that trump the preeminent patent pools formed by Respondent, the patents of which were evaluated by Respondent, the organization of which is counseled by Respondent, and the licensee and licensor list of which Respondent counts as some of his clients as described at the URL at http://www.proskauer.com/lawyers_at_proskauer/atty_data/4747, where his client list includes some of those companies listed in the MPEG 2 patent pool, and highlighted as attached herein as [Exhibit F](#).

Furthermore, Respondent is seen pointed to by former company executive management, and named in multiple Company business plans authored by and reviewed and billed for by Mr. Wheeler and delivered to Respondent's for his review, and by potential license partners as the "go to" individual regarding information and opinions on the Company's inventions examples of which are attached herein as [Exhibit G](#).



Thomas J. Cahill, Esq.
7/2/2003
Page 7

B. More importantly, the Company points to his alleged mutterings that “**THIS CHANGES EVERYTHING,**” wherein “**EVERYTHING**” allegedly refers to Respondent’s formation, patent evaluation, and counseling to the organization MPEG LA, LLC that coordinates the MPEG 2 and MPEG 4 patent pools of which the Company’s inventions are a competitive threat.

Factually, the Company has knowledge that, as well as Respondent holding the position of counsel by his own admission, Respondent holds the position of patent evaluator, and wherein Respondent: (a) may personally profit as said patent evaluator by, to the best of the Company’s knowledge, receiving a fee of Eight Thousand Five Hundred Dollars (\$8,500) per patent review¹⁰; (b) wherein Mr. Rubenstein counts as among his clients certain licensors and licensees of said patent pools, and receives remuneration as the billing Partner in representation of those clients by Respondent and Proskauer; and (c) wherein it is in the best personal, financial interest of Respondent to direct and engage with Mr. Joao and Mr. Wheeler in said series of dishonesties, appearances of untrustworthiness, conduct involving dishonesty, fraud, deceit, and misrepresentation to remove the competitive threat of the Company’s inventions to said multimedia patent pools, thereby securing his own personal gain and, perhaps, that of Proskauer.

Lastly, given this time line of events concerning Respondent, who is desirous of maintaining Respondent’s personal financial gains, esteem, probable gains to Respondent’s employer, Proskauer, other gains from representing a soon to be trillion dollar technology in MPEG 2, and clients from the multimedia patent pools and has recruited Mr. Joao to assist, the Company alleges, in the burying the Company’s inventions, it becomes strikingly unusual that Respondent and other former members and associates of MLGS who at the time just transferred with Respondent to Proskauer, pass on the patent prosecution work of the Company for their new employer, Proskauer, and

¹⁰ First Judicial Department Departmental Disciplinary Committee should be apprised of the fact that: (i) said patent pool known as MPEG 2 contains, as of even date above, approximately Five Hundred and Eighty (580) essential patents, and contains some eighty to ninety percent (80% to 90%), according to industry observers, of the essential patents relevant to this pool; (ii) that said patent pool known as DVD contains, as of even date above, approximately Six Hundred and Seventy Five (675) essential patents, and the Company has no knowledge as to what percentage of the essential patents are contained relevant to this pool; and (iii) that said patent pool known as MPEG 4 presently contains approximately One Hundred (100) essential patents, and by the Company’s estimation contains approximately twenty five percent (25%) of the essential patents relevant to this pool; (iv) that by virtue of (i) and (ii) herein, Respondent may have personally profited, absent any sharing with his former or present employers or in the operating budget of MPEG LA, LLC, in the amount of approximately Five Million Seven Hundred Thousand Dollars (\$5,700,000); and (v) that by virtue of (iii) herein, Respondent may stand, from this activity alone, to personally profit in the future, absent any sharing with his present employer or the operating budget of MPEG LA, LLC, of approximately Two Million Five Hundred Thousand Dollars (\$2,500,000), as well as profiting, the Company alleges, in other ways from the burying of the Company’s technologies, or resurrecting them with a cumulative present value of up to Seventeen Billion Dollars (\$17,000,000,000) over twenty (20) year patent life.



Thomas J. Cahill, Esq.
7/2/2003
Page 8

refer it back to their former law firm, MLGS, and an attorney, in one Mr. Joao, who seemingly drops out of the sky and has no connection to the former attorneys, or do Respondent and Mr. Joao have a former connection? Moreover, and at this point in the time line, Respondent has already opined that the Company's inventions are "novel" and essential to MPEG, as well as, in the Company's opinion, a competitive threat to MPEG, which lends great support to the Company's contentions that Respondent saw the personal financial gains, esteem, and current and prospective clients from the multimedia patent pools as needs to bury the Company's inventions.

Finally, it is proximate to this series of events and circumstances that the Company alleges that Respondent, desirous of maintaining Respondent's personal, financial gains, esteem, and clients from the multimedia patent pools and has recruited Mr. Joao to assist, the Company alleges, in the burying the Company's inventions, engaged, with and while acting as the overseer of Mr. Joao, in conduct involving dishonesty, fraud, deceit, and misrepresentation, wherein Respondent who has recruited Mr. Joao to assist, the Company alleges, in the burying the Company's inventions by missing critical elements in the provisional patent applications, as attached herein as [Exhibit H](#); Mr. Bernstein, the other inventors, former President & COO Brian G. Utley, and representatives of the "seed" investor, an affiliate of Huizenga Holdings, Inc. find: (I) flaws in patent applications; (II) material differences between what was disclosed and contained in filed patent applications, as further described in Exhibit H by the letter of Mr. Utley; and (III) patent applications that do not include all the inventors¹¹.

C. Still further, the opinions of Respondent are instrumental in the "seed" funding of the Company by an affiliate of Huizenga Holdings, Inc. (Wayne Huizenga of Blockbuster fame) wherein Respondent interfaces with the Huizenga investment professionals, and Mr. Wheeler reiterates Respondent's opinions regarding the Company's inventions. Similarly, Mr. Wheeler relays Respondent's opinions to Goldman Sachs Group, Inc., Gruntal & Co. (presently a unit of Raymond James Financial Inc.), and a whole host of other investors and potential license partners now conducting the unauthorized use of the Company technologies under NDAs not enforced by Respondent and Mr. Wheeler.

Lastly, to investors in the Company, it was the representation of Respondent and Mr. Wheeler that Respondent's patent pools and other interested clients of Respondent and Mr. Wheeler would license the Company's technologies; it was also represented that Respondent made positive decisions on the essentiality of the Company's patents pending to potential licensees of the Company, in particular with respect to Warner Bros., and his close association with a one Gregory B. Thagard, an individual who is the named, or one

¹¹ 35 U.S.C. Sec. 116 (1985).



Thomas J. Cahill, Esq.
7/2/2003
Page 9

of the named inventor(s) for approximately thirteen patents in the DVD patent pool¹² and was associated with Respondent in the Massachusetts Institute of Technology's Media Lab; instances of investor and licensee representations are more particularly described by [Exhibit I](#).

D. Lastly, through his many denials and, factual outright disavowing numerous items in his deposition with regard to the Litigation, wherein such Litigation is wholly irrelevant to the Complaint, but is instructive for these purposes, Respondent outright disavows:

1. any knowledge whatsoever of the Company;¹³
2. any knowledge whatsoever of Mr. Bernstein and the other true inventors;¹⁴
3. any knowledge whatsoever of techniques known as pan and zoom technology;¹⁵
4. and through his refusal to answer questions regarding the allegedly vicariously liable MPEG LA, LLC¹⁶ amongst others;
5. his charge that the deposition was harassment in that he had nothing to do with the Company;¹⁷
6. his steadfast denial of technology known as scaled video;¹⁸
7. his claim as to never opining on the Company's technology;¹⁹
8. his denial of ever having been involved in meetings concerning the Company;²⁰
9. his denial of ever having any discussion with anyone at Proskauer concerning the Company's technology;²¹
10. his admission of not keeping notes or records of his conversations to Mr. Wheeler;²²
11. his acknowledgement of never having billed the Company, though his name appears more than a dozen times, absent those billings that may have purposely removed, in billings from Mr. Wheeler's office;²³
12. his denial of making any representations to any party with regard to the Company's technologies;²⁴
13. his stunning reversal of his possible conversation with third parties regarding the

¹² As to conflicts of interest, it should be similarly noted that the DVD patent pool also benefits from the Company's technologies, and that Respondent fails to disclose same with respect to his discussions with Mr. Thagard that the Company was apprised by Mr. Thagard.

¹³ *Supra* Note 1 at 10-11.

¹⁴ *Supra* Note 1 at 11.

¹⁵ *Supra* Note 1 at 10.

¹⁶ *Supra* Note 1 at 12.

¹⁷ *Supra* Note 3.

¹⁸ *Supra* Note 1 at 22-23.

¹⁹ *Supra* Note 1 at 23.

²⁰ *Supra* Note 1 at 24.

²¹ *Supra* Note 1 at 26.

²² *Supra* Note 1 at 43.

²³ *Supra* Note 1 at 43.

²⁴ *Supra* Note 4.



Thomas J. Cahill, Esq.
7/2/2003
Page 10

Company's technologies;²⁵ and,
14. and his lack of knowledge as to why his name appears in an electronic mail message to a member of AOL Time Warner's investment team, wherein that message states that Respondent opined on the Company's technologies.²⁶

Accordingly, by subparagraphs 1 to 14 above, Respondent has engaged in other conduct that adversely reflects on Respondent's fitness as a lawyer, in light of said denials of which the Company shall conclusively prove otherwise, *infra*.

II. DR 1-103 [§1200.4] Disclosure of Information to Authorities.

A. The Company realleges and incorporates by this reference herein, as though fully set forth, Section I Subsection A-D, inclusive. Moreover, the Company further re-alleges that Respondent who is desirous of maintaining Respondent's personal financial gains, esteem, probable gains to Respondent's employer, Proskauer, other gains from representing a soon to be trillion dollar technology in MPEG 2, and clients from the multimedia patent pools and has recruited Mr. Joao to assist, the Company alleges, in the burying the Company's inventions, possessed knowledge of a violation of DR 1-102 [§1200.3] that raises a substantial question as to the honesty of Mr. Joao, Mr. Joao's trustworthiness, Mr. Joao's fitness as a lawyer, whom Respondent has recruited to assist, the Company alleges, in the burying the Company's invention, whereby Respondent failed to report such knowledge to a tribunal or other authority empowered to investigate or act upon such violation.

Still further, and by [Exhibit I](#), the Company alleges Respondent's awareness of violations of Mr. Joao during a meeting at Respondent's New York office with a one Steven Filipeck, Esq. representing Huizenga Holdings, as well as others, pertaining to the Company's patent filings, and based on Mr. Filipeck's review of Mr. Joao's, under the direction of Respondent, provisional work; Huizenga Holdings, Inc. was the initial investor in the Company and this meeting materially impacts future Huizenga investments which, as a result of the faulty provisional patent applications, were never forthcoming.

Moreover, the Company further alleges that Respondent had knowledge of a violation of DR 1-102 [§1200.3] that raises a substantial question as to the honesty of a one William J. Dick, Esq. of Foley & Lardner, Milwaukee, Wis. and Mr. Utley, whereby Respondent similarly failed to report such knowledge to a tribunal or other authority empowered to investigate or act upon such violation.

²⁵ *Supra* Note 1 at 75.

²⁶ *Supra* Note 1 at 87.



Thomas J. Cahill, Esq.
7/2/2003
Page 11

Still further, the Company further alleges that Respondent had knowledge of a violation of DR 1-102 [§1200.3] that raises a substantial question as to the honesty of Mr. Wheeler, whereby Respondent similarly failed to report such knowledge to a tribunal or other authority empowered to investigate or act upon such violation.

Lastly, the Company further alleges that Respondent may have had knowledge of factors that may raise a substantial question as to the honesty of a one H. Hickman Powell III and Stephen J. Warner, Managing Director and Co-Founder and Chairman, respectively, of one Crossbow Ventures, Inc. of West Palm Beach, Fla., an affiliate of which was the Company's lead investor, whereby Respondent similarly failed to report such knowledge to a tribunal or other authority empowered to investigate or act upon such violation.

Moreover, with respect to Messrs. Powell and Warner and Crossbow, in late 1999, they were introduced to the Company by Mr. Wheeler, who had indicated to the Company that they were interested in an equity investment in the Company once they had conducted a thorough due diligence review of the Company's intellectual property and provisional patent filings with a independent third party patent counsel, and in conjunction with Respondent and Mr. Joao. Clearly, as Crossbow proceeded to invest a total of Four Million Dollars consisting of One Million Eight Hundred Thousand Dollars (\$1,800,000) in convertible preferred stock (January 2000), One Million Two Hundred Thousand Dollars (\$1,200,000) in unsecured notes (December 2000), and Eight Hundred Thousand Dollars (\$800,000) in secured notes²⁷ (May to September 2001) in the Company, said independent intellectual property review passed with flying colors, but what strikes the Company as unusual is that the independent intellectual property review by Crossbow in conjunction with Respondent and Mr. Joao, is in diametric opposition to the review of Foley & Lardner, and in diametric opposition to the review of the Company's present patent prosecution counsel of Blakely, Sokoloff, Taylor & Zafman LLP of Los Angeles, Cal., and lastly, is in diametric opposition to the review of the Company's latest patent review counsel, the Chicago office of Greenberg Traurig LLP.

Finally, following the time line of events, the termination of Mr. Utley for cause follows with a breach of contract action (since dismissed) by, among others, Mr. Utley, followed by Mr. Utley's petition in an involuntary bankruptcy (since dismissed) against the Company, followed by the Litigation (pending) by and between the Company and Proskauer, wherein such litigation is wholly irrelevant to the Complaint, but is instructive for these purposes, followed by the execution of Crossbow's secured notes collateralized by the Company's intellectual property, followed by the halting of funding by Crossbow Ventures that was far lower than the committed amount for that round, followed by a demand letter for accrued but unpaid interest by Crossbow Ventures to the Company, followed by a default notice and demand for all principal and accrued but unpaid interest

²⁷ The secured notes, supposedly, were to protect the Company from the lawsuits of Mr. Utley and Proskauer cited directly below.



Thomas J. Cahill, Esq.
7/2/2003
Page 12

under the secured notes by Crossbow Ventures to the Company, and followed by a notice of assignment of the intellectual property of the Company by Crossbow Ventures (presently the subject of dispute), followed by a transfer of the secured notes contrary to the rules of the Securities Act of 1933, to the best of the Company's knowledge (presently, the subject of a complaint to the United States Securities and Exchange Commission), followed by Crossbow's false statements to The Palm Beach Post that "[Crossbow]sold one of its companies, iviewit.com,²⁸" and the Company finds itself asking:

Are not all these individuals and entities the referrals of Proskauer, Mr. Wheeler, and Respondent, and introduced after Respondent has been apprised of the Company inventions, and declaring them as 'novel,' and that '[Respondent] missed that,' and that '[Respondent] never thought of that,' and, lastly Respondent's statement that 'this changes everything,' and whereby the efforts of a preeminent multimedia patent counsel, such as Respondent or another, who is desirous of maintaining Respondent's personal financial gains, esteem, and clients from the multimedia patent pools and has recruited Mr. Joao to assist, the Company alleges, in the burying the Company's inventions, may be of utilization later after the above said series of events rendered the Company, its inventors, the predominance of its shareholders, absent Mr. Utley and Crossbow and Proskauer, neutralized, in the resurrection of the Company's inventions for the benefit of Respondent, Mr. Wheeler, Proskauer, Mr. Powell, Mr. Warner, Crossbow, and Mr. Utley?

Graphically, a description of the Company's question may be represented by the following:

[The remainder of this page intentionally left blank]

²⁸ Stephen Pounds, *Venture Capital Deals Suffering*, The Palm Beach Post, January 11, 2003, at 10B.

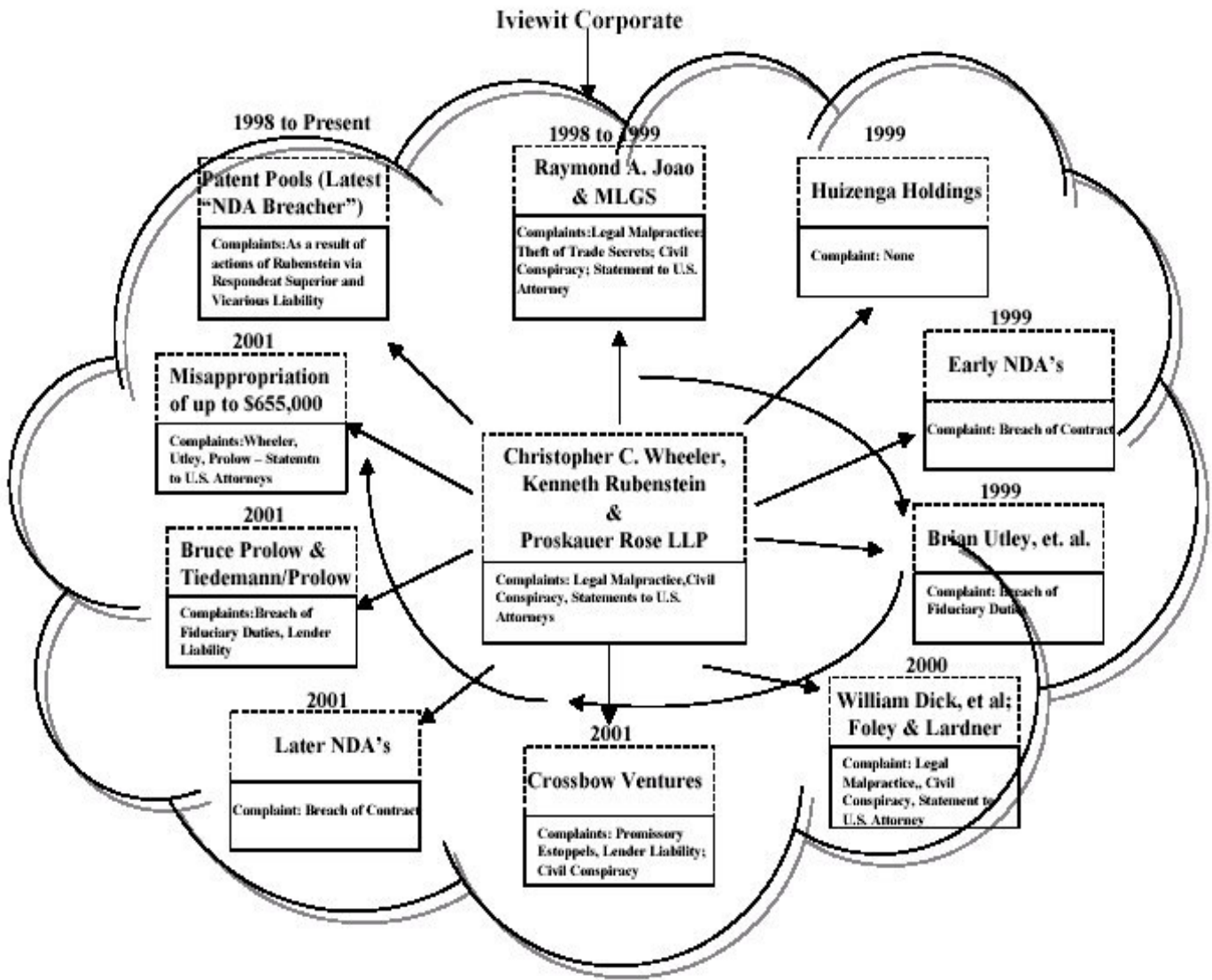



Thomas J. Cahill, Esq.
7/2/2003
Page 14

B. Similarly, the Company re-alleges that Respondent, who is desirous of maintaining Respondent's personal financial gains, esteem, and clients from the multimedia patent pools and has recruited Mr. Joao to assist, the Company alleges, in the burying the Company's inventions possessed knowledge or evidence, not protected as a confidence or secret, concerning Mr. Joao, without revealing such knowledge or evidence to the United States Patent and Trademark Office ("USPTO") and other authorities empowered to investigate or act upon the irresponsible conduct of Mr. Joao.

C. Moreover, the Company further alleges that Respondent had knowledge of a violation of DR 1-102 [§1200.3] that raises a substantial question as to the honesty of ones Steven Becker and Douglas Boehm of Foley & Lardner and, whereby Respondent similarly failed to report such knowledge to a tribunal or other authority empowered to investigate or act upon such violation.

III. DR 1-104 [§1200.5] Responsibilities of a Partner or Supervisory Lawyer and Subordinate Lawyers.

A. The Company re-alleges and incorporates by this reference herein, as though fully set forth, Section I Subsection A-D, and Section II Subsection A-C, inclusive. More specifically, the Company re-alleges that Respondent, who is desirous of maintaining Respondent's personal financial gains, esteem, and clients from the multimedia patent pools and has recruited Mr. Joao to assist, the Company alleges, in the burying the Company's inventions, is responsible for a violation of the Disciplinary Rules by Mr. Joao whereby: (I) Respondent ordered and directed the irresponsible misconduct of Mr. Joao in burying the Company's technologies, and, with full knowledge of Mr. Joao's specific misconduct, ratified said misconduct; (II) Respondent ordered and directed, in conjunction with Mr. Wheeler, the irresponsible misconduct of subsequent patent counsel Mr. Dick, a one Steven Becker, a one Douglas Boehm all of Foley & Lardner, and Mr. Utley in continuing to bury the Company's technologies, and, with full knowledge of their specific misconduct, ratified said misconduct; and (III) Respondent had supervisory authority over these individuals and knew of such misconduct that Respondent, ordered, directed, and ratified, and in the exercise of reasonable management and supervisory authority where Respondent knowing of said misconduct failed to take remedial action at a time when the consequences of their misconduct could be or could have been avoided or mitigated²⁹.

B. Lastly, and aside from the fact that Respondent ordered and directed the irresponsible misconduct of Mr. Joao in burying the Company's technologies, and, with full

²⁹ Much in the same way that, in other forums, the doctrines of *respondeat superior* and vicarious liability would impinge liability upon Respondent for the wanton acts of Mr. Joao, and wherein the scope of Mr. Joao's employment indicates a principal-agent relationship by and between Respondent and Mr. Joao.



Thomas J. Cahill, Esq.
7/2/2003
Page 15

knowledge of Mr. Joao's specific misconduct, ratified said misconduct, Respondent was negligible in the referral to Mr. Joao in that Mr. Joao presently has numerous patents issued and patent applications pending since meeting the inventors, nearly eighty (80) in total, and where these inventions concern those allegedly learned through his engagement with the Company, the royalties, if measured along the lines of the MPEG 2 patent pool, can represent upwards of, if not more than, Twelve Million Dollars (\$12,000,000) per annum; similarly, Respondent was negligent in Proskauer's referral of Foley & Lardner, whereby the lead counsel to the Company, Mr. Dick, was previously involved in alleged intellectual property malfeasances with Mr. Utley, and considering the particular patent applications wrongly written into Mr. Utley as the sole inventor, and sent to Mr. Utley's home, and without Mr. Utley assigning said inventions to the Company, and where Foley & Lardner had full knowledge of Mr. Utley's inability to invent said technologies, the royalties flowing from these nearly misappropriated inventions might approach more than One Billion Dollars (\$1,000,000,000) annually.

IV. DR 1-107 [1200.5-c] Contractual Relationships Between Lawyers and Nonlegal Professionals

A. The Company re-alleges and incorporates by this reference herein, as though fully set forth, Section I Subsection A-D, Section II Subsection A-C, and Section III Subsection A, inclusive. Moreover, the Company further re-alleges that Respondent's practice of law during his representation of the Company lacked the essential tradition of complete independence and uncompromised loyalty to the Company as a result of Respondent's representation as counsel and, to the best of the Company's knowledge, patent evaluator, to the entity known as MPEG LA, LLC, or the licensor of those essential patents known as MPEG 2 and MPEG 4, the DVD patent pool administered by DVD 6C Licensing Agency, that the Company's technologies provide for a competitive threat, as evidenced by [Exhibit J](#) attached herein, and other clients, wherein Respondent refuses to answer questions in his deposition with regard to the Litigation³⁰, wherein such Litigation is wholly irrelevant to the Complaint, but is instructive for these purposes, concerning questions pertaining to MPEG LA, LLC, as, the Company alleges, Respondent is fully aware that the misconduct of Mr. Joao as overseen by Respondent, would rise to the level of MPEG LA, LLC through doctrines of *respondeat superior* and vicarious liability, thereby impinging upon Respondent's personal financial gains whereby Respondent, who is desirous of maintaining Respondent's personal financial gains, esteem, probable gains to Respondent's employer, Proskauer, other gains from representing a soon to be trillion dollar technology in MPEG 2, and clients from the multimedia patent pools and has recruited Mr. Joao to assist, the Company alleges, in the burying the Company's inventions

B. Moreover, the Company re-alleges that Respondent's representation of the Company

³⁰ *Supra* Note 14.



Thomas J. Cahill, Esq.
7/2/2003
Page 16

lacked the tradition of complete independence and uncompromised loyalty as outlined in this Section, Subsection A, as a result of Respondent's simultaneous representation of MPEG LA, LLC as well as other clients possessing overlapping interests with respect to the Company, the Company lacked the guarantee of independent professional judgment and undivided loyalty uncompromised by conflicts of interest in its representation by Respondent when viewing the Company's technologies as competitive threats to those technologies licensed by MPEG LA, LLC and Respondent's personal financial gains as its counsel, and to the best of the Company's knowledge, patent evaluator.

Lastly, as a result of this Section Subsections A and B, the Company re-alleges that Respondent failed: (I) in his responsibility to maintain his or own independent professional judgment; (II) to maintain the confidences and secrets of the Company; and (III) to otherwise comply with the legal and ethical principles governing lawyers in New York State.

V. DR 4-101 [§1200.19] Preservation of Confidences and Secrets of a Client.

A. The Company re-alleges and incorporates by this reference herein, as though fully set forth, Section I Subsection A-D, Section II Subsection A-C, Section III Subsection A, and Section IV Subsection A-C, inclusive. Wherein, "confidence" refers to information protected by the attorney-client privilege under applicable law, and "secret" refers to other information gained in the professional relationship that the Company had requested be held inviolate and the disclosure of which would likely be detrimental to the Company, the Company further re-alleges that Respondent (I) used the confidences and trade secrets of the Company to the disadvantage of the Company; (II) revealed, by using for Respondent's own gain, esteem, probable gains to Respondent's employer, Proskauer, other gains from representing a soon to be trillion dollar technology in MPEG 2, and clients from the multimedia patent pools and has recruited Mr. Joao to assist, the Company alleges, in the burying the Company's inventions, confidences and trade secrets of the Company, to the disadvantage of the Company; and (III) Respondent failed to exercise reasonable care to prevent his clients from disclosing and using the confidences and trade secrets of the Company.

More specifically, the Company re-alleges that Respondent revealed confidences and trade secrets of the Company to the disadvantage of the Company as evidenced by the billings of Proskauer wherein Respondent is named numerous times and has participated in numerous hours of billings by Proskauer, attached herein as [Exhibit K](#). Furthermore, in his response, Respondent points to the fact that he has not billed for one hour of work³¹ in representation of the Company, whereby by Exhibit K, the Company finds itself asking "Does Respondent work for free?" and answers by replying "No, but only when

³¹ Kenneth Rubenstein, *Response to Complaint of Eliot Bernstein Against Kenneth Rubenstein*, First Judicial Department Departmental Disciplinary Committee Docket 2003.0531 5 (April 11, 2003).



Thomas J. Cahill, Esq.
7/2/2003
Page 17

Respondent, who is desirous of maintaining Respondent's personal financial gains, esteem, probable gains to Respondent's employer, Proskauer, other gains from representing a soon to be trillion dollar technology in MPEG 2, and clients from the multimedia patent pools and has recruited Mr. Joao to assist, the Company alleges, in the burying the Company's inventions, and perhaps the facts of the matter, cross-currently, see Mr. Utley, Mr. Wheeler, and Crossbow preparing for burying the Company itself, as a means to cloak his involvement in the burying of the Company's inventions." Moreover, it should be similarly noted with respect to the billings of Proskauer that the Company further alleges that Proskauer's early bills bear eerie evidence of possible tampering, and wherein Respondent's name and patent discussion entries may have been attempted to be removed in an effort to exculpate Respondent.

Furthermore, the Company re-alleges that Respondent revealed, by using for Respondent's own gain, confidences and trade secrets of the Company, to the disadvantage of the Company according to the same analysis in this Section, Subsection A.

B. Lastly, the Company re-alleges that Respondent failed to exercise reasonable care to prevent his clients from disclosing and using the confidences and trade secrets of the Company as evidenced by the URL at <http://trailers.warnerbros.com/web/category.jsp?id=action>, whereby on the website of Warner Bros, a client of Respondent as evidenced by Mr. Wheeler's second response³² to the Company's Complaint against Mr. Wheeler, a viewer who selects an action trailer and choosing Windows Media Player at a connection speed of 300k and when observing the trailer and right clicking the viewer's personal computer mouse and choosing the option "statistics" and then choosing the option "advanced," the quality of video seen at the specified bit rate and connection speed that deliver twenty (24) to thirty (30) full screen frames per second (termed "full frame rates" to those skilled in the art) is mathematically impossible to deliver other than by use of the Company's inventions, as corroborated by the letter of David Colter, former Vice President of Advanced Technology of Warner Bros., and all attached herein as [Exhibit L](#).

VI. DR 5-101 [§1200.20] Conflicts of Interest - Lawyer s Own Interests

A. The Company re-alleges and incorporates by this reference herein, as though fully set forth, Section I Subsection A-D, Section II Subsection A-C, Section III Subsection A, Section IV Subsection A-C, and Section V Subsection A-D, inclusive. Moreover, the Company further re-alleges that Respondent, who is desirous of maintaining Respondent's personal financial gains, esteem, probable gains to Respondent's employer, Proskauer, other gains from representing a soon to be trillion dollar technology in MPEG 2, and clients from the multimedia patent pools and has recruited Mr. Joao to assist, the

³² Christopher Wheeler, Complaint of Eliot Bernstein Against Christopher Wheeler, The Florida Bar File No. 2003-51, 109 (15C) 5 (May 23, 2003).



Thomas J. Cahill, Esq.
7/2/2003
Page 18

Company alleges, in the burying the Company's inventions, and perhaps the facts of the matter, cross-currently, see Mr. Utley, Mr. Wheeler, and Crossbow preparing for burying the Company itself, continued his employment by MPEG LA, LLC, and whereby said employment materially affected Respondent's judgment to the detriment of the Company as a result of Respondent's own financial, business, property, and personal interests, and whereby the Company gave no consent to the representation in light of the implications of the Respondent's interest.

Furthermore, by this violation of DR 5-101, it becomes more apparent when viewed in terms of that neither Respondent nor Mr. Wheeler³³ are cognizant of whether Proskauer conducted a no conflict of interest verification. Still further, the Company further alleges that Respondent, Mr. Wheeler, and Mr. Joao were in receipt of proprietary and confidential Company information without the benefit of a retainer agreement³⁴ or no conflict of interest verification, and whereby a no conflict of interest verification was conducted approximately twelve months after the first technology disclosures by the Company to Mr. Wheeler, Respondent, and Mr. Joao, as described in [Exhibit F](#), *supra*.

VII. DR 5-105 [§1200.24] Conflict of Interest; Simultaneous Representation.

A. The Company re-alleges and incorporates by this reference herein, as though fully set forth, Section I Subsection A-D, Section II Subsection A-C, Section III Subsection A, Section IV Subsection A-C, Section V Subsection A-D, and Section VI Subsection A, inclusive. Moreover, the Company further alleges that Respondent, who is desirous of maintaining Respondent's personal financial gains, esteem, probable gains to Respondent's employer, Proskauer, other gains from representing a soon to be trillion dollar technology in MPEG 2, and clients from the multimedia patent pools and has recruited Mr. Joao to assist, the Company alleges, in the burying the Company's inventions, and perhaps the facts of the matter, cross-currently, see Mr. Utley, Mr. Wheeler, and Crossbow preparing for burying the Company itself, failed to decline the continued proffered employment by MPEG LA, LLC and his other clients, and that as a result of Respondent's failure to decline said employment, Respondent's exercise of independent professional judgment on behalf of the Company was adversely affected by Respondent's continuation of said proffered employment by, including but not limited to, MPEG LA, LLC, and that it was likely to involve Respondent in representing differing interests.

B. Furthermore, the Company re-alleges that Respondent continued the said multiple

³³ Deposition of Christopher Wheeler at 10-12, *Proskauer Rose LLP v. Iviewit.com, Inc. et. al.* Case No. CA 01-04671 AB (Circuit Court of the 15th Judicial Circuit in and for Palm Beach County, Florida filed May 2, 2001).

³⁴ While a September 1999 retainer agreement appears to have been executed, the Company does not attest to its validity as it appears a private document between Mr. Wheeler and Mr. Utley and was executed nearly one year after patent disclosures had begun.



Thomas J. Cahill, Esq.
7/2/2003
Page 19

employment by both, including but not limited to, MPEG LA, LLC and the Company when Respondent's exercise of independent professional judgment on behalf of the Company was adversely affected by the Respondent's representation of, including but not limited to, MPEG LA, LLC, and that it resulted in Respondent representing differing interests with material conflicts across his client roster, Proskauer's clients under NDA, the multimedia patent pools in general, and MPEG 2 in particular, that has a potential to generate royalties in the trillions of dollars at the time in which digital television is the quintessential entertainment client in end users viewing areas. Moreover, Respondent, in his deposition with regard to the Litigation, wherein such Litigation is wholly irrelevant to the Complaint, but is instructive for these purposes, states his inability to recall his financial package³⁵ as well as his date of employment³⁶ with Proskauer, which, the Company alleges, reveals Respondent's motives, when viewed in terms of his desire to maintain Respondent's personal financial gains, esteem, probable gains to Respondent's employer, Proskauer, other gains from representing a soon to be trillion dollar technology in MPEG 2, and clients from the multimedia patent pools and has recruited Mr. Joao to assist, the Company alleges, in the burying the Company's inventions and perhaps the facts of the matter, cross-currently, see Mr. Utley, Mr. Wheeler, and Crossbow preparing for burying the Company itself, and as evidenced by [Exhibit M](#) attached herein³⁷. Additionally, also presented in Exhibit M are: (I) a compact disc recording of a taped conversation by and between Mr. Bernstein and inventor Shirajee that points to the absolute knowledge by Respondent, Mr. Joao, and Mr. Wheeler as to the Company's true inventors; (II) the statement of former Chairman of the Company's Board of Directors, Simon Bernstein; and (III) the statements of other former employees, shareholders, investors and clients all possessing knowledge of the alleged malfeasances and misfeasances of Respondent, Mr. Joao, and Mr. Wheeler.

The Company re-alleges that Respondent's employer, Proskauer, failed to maintain records of Respondent's outside interests with, including but not limited to, MPEG LA, LLC, and similarly failed to implement a system by which the proposed engagement with the Company was checked against Respondent's employment by, including but not limited to, MPEG LA, LLC, and whereby the case of representation of the Company was a substantial factor in causing a violation of DR 5-105 by Respondent, who is desirous of maintaining Respondent's personal financial gains, esteem, probable gains to

³⁵ *Supra* Note 1 at 8.

³⁶ *Supra* Note 1 at 6.

³⁷ The Company requests First Judicial Department Departmental Disciplinary Committee to: (I) direct Respondent and Proskauer to reveal the total financial compensation of Respondent, including but not limited to, base salary from Proskauer, bonus, profit sharing, and sharing in any of Respondent's compensation as patent evaluator; (II) the timeline pertaining to Respondent's employment by MLGS and Proskauer; (III) submission for review by the Company all files of Proskauer; (IV) the prior relationship between Respondent and Mr. Joao; and (V) matching exhibits herein due to prospect of altering by "hackings" of the Company's information systems. Such revelations would materially shed light on the Company's Complaint.



Thomas J. Cahill, Esq.
7/2/2003
Page 20

Respondent's employer, Proskauer, other gains from representing a soon to be trillion dollar technology in MPEG 2, and clients from the multimedia patent pools and has recruited Mr. Joao to assist, the Company alleges, in the burying the Company's inventions, and perhaps the facts of the matter, cross-currently, see Mr. Utley, Mr. Wheeler, and Crossbow preparing for burying the Company itself.

VIII. DR 5-108 [§1200.27] Conflict of Interest - Former Client.

The Company re-alleges and incorporates by this reference herein, as though fully set forth, Section I Subsection A-D, Section II Subsection A-C, Section III Subsection A, Section IV Subsection A-C, Section V Subsection A-D, and Section VI Subsection A, and Section VII Subsection A-C, inclusive. Moreover, the Company further re-alleges that Respondent, after the representation of the Company continued to represent, including but not limited to, MPEG LA, LLC in the same and substantially related matter in which Respondent's and Proskauer's interests are materially adverse to the interests of the Company, as Respondent, who is desirous of maintaining Respondent's personal financial gains, esteem, probable gains to Respondent's employer, Proskauer, other gains from representing a soon to be trillion dollar technology in MPEG 2, and clients from the multimedia patent pools and has recruited Mr. Joao to assist, the Company alleges, in the burying the Company's inventions, and perhaps the facts of the matter, cross-currently, see Mr. Utley, Mr. Wheeler, and Crossbow preparing for burying the Company itself

A. The Company re-alleges that Respondent used the confidences and trade secrets of the Company to the detriment of the Company.

B. The Company re-alleges that without the consent of the Company, Respondent knowingly continued to represent, including but not limited to, MPEG LA, LLC in the same and substantially related matters in which Respondent had previously represented the Company and: (I) Respondent's interests and the interests of Proskauer are materially adverse to the Company; and (II) Respondent had acquired information protected by section DR 4-101 [1200.19](B) that is material to the matter.

IX. DR 7-101 [§1200.32] Representing a Client Zealously.

A. The Company re-alleges and incorporates by this reference herein, as though fully set forth, Section I Subsection A-D, Section II Subsection A-C, Section III Subsection A, Section IV Subsection A-C, Section V Subsection A-D, and Section VI Subsection A, Section VII Subsection A-C, and Section VIII Subsection A-C, inclusive. Furthermore, Company re-alleges that Respondent intentionally failed to seek the lawful objectives of the Company through reasonably available means permitted by law and the Disciplinary Rules.



Thomas J. Cahill, Esq.
7/2/2003
Page 21

More specifically, the representation by Respondent, who is desirous of maintaining Respondent's personal financial gains, esteem, probable gains to Respondent's employer, Proskauer, other gains from representing a soon to be trillion dollar technology in MPEG 2, and clients from the multimedia patent pools and has recruited Mr. Joao to assist, the Company alleges, in the burying the Company's inventions, and perhaps the facts of the matter, cross-currently, see Mr. Utley, Mr. Wheeler, and Crossbow preparing for burying the Company itself, in his role as overseer of the Company's patent prosecution process, is aware that his direction of Mr. Joao has the stated goal of filing the provisional patent application for the Company's imaging invention by January 1999, and a goal not fulfilled until more than three months later, and wherein all disclosures had occurred while the Respondent and Mr. Wheeler, under the umbrella of Proskauer, had neither executed a retainer agreement with the Company nor conducted conflict checks, but only approximately twelve months after the Company's technology disclosures, all conduct of which reflects negatively on Respondent, Mr. Wheeler, and Proskauer.

Moreover, Respondent erroneously claims that foreigners could not be listed as inventors in diametric opposition to Section 115 of the Patent Act³⁸, a true copy of which is attached herein as [Exhibit N](#), which, according to the Company's best understanding may invalidate any patents at issuance; thereafter, Mr. Wheeler expedites, and bills for such, the immigration status of Mr. Shirajee and Mr. Rosario so that they may be listed as inventors; still at this point, Mr. Joao, under the direction of Respondent, fails to state proper inventors.

Still further, the Company required Respondent's participation, and wherein Respondent willfully failed to participate, by teleconference during its first major technology disclosure with Real 3D, Inc. (then a consortium of Intel Corp., Silicon Graphics, Inc., and Lockheed Martin Corp), during which time it was found that Mr. Joao, under the direction of Respondent, protected only the imaging invention, and wherein the Company cannot make full disclosures of the video invention and the combination of imaging and scaled video where, Mr. Wheeler, after the meeting, calls Respondent who opines that no damage may result from the late filings as the protection of the inventions rest on the date of invention and not the filing dates; unfortunately, Respondent was remiss in failing to state that the international patent system relies on a "first to file" basis, rather than his stated invention date instructions, and thus potentially exposes the Company's international patent portfolio based on the late filings of imaging, video scaling, and the combination of imaging and scaled video.

B. Still further, the Company references the removal of Mr. Joao as the Company patent prosecutor, under the direction of Respondent, and his replacement by Foley & Lardner, specifically referred by Mr. Wheeler and Mr. Utley, and still under the direction of

³⁸ 35 U.S.C. Sec. 115 (1985).



Thomas J. Cahill, Esq.
7/2/2003
Page 22

Respondent. The Company further alleges that Respondent is negligent in the oversight of Foley & Lardner's work as they fail to: (a) correct the mistakes of Mr. Joao, pursue non-provisional patent prosecution for the Company that results in flawed work of their own, still under the direction of Respondent, and when corrected by the Company, still file non-provisional patent applications filled with flaws; (b) file non-provisional patent applications with missing and changed inventors; (c) write non-provisional patent applications into the name of the Company's President & Chief Operating Officer, a one Brian G. Utley, with no assignment to the Company, and an individual who had a close association with the Foley & Lardner lead, Mr. Dick, with full knowledge that Mr. Utley could not and was not inventor of the subject matter of those non-provisional applications; and (d) failed to disclose the former intellectual property malfeasances of Mr. Utley and Mr. Dick at Mr. Utley's former employer, Diamond Turf Lawnmower in Florida.

B. Moreover, the Company re-alleges that Respondent tortuously interfered with a business contract by and between the Company and Warner Bros, wherein a one Wayne M. Smith, Vice President and Senior Litigation and Patent Counsel called upon Respondent to re-opine, as he had many times before, and Respondent refuses based upon his stated conflicts of interest when such conflicts of interest were not stated during the times of the Company's technology disclosures to Respondent nor in Respondent's previous discussions with Warner Bros., and in light of his proffered employment by, including but not limited to, MPEG LA, LLC. Most specifically, the Company submits the statement of P. Stephen Lamont, Chief Executive Officer ("CEO Lamont") that describes his December 2001 to April 2002 discussions and correspondences with Respondent attached herein as [Exhibit O](#), prefaced by letters of David Colter, former Vice President for Advanced Technology of Warner Bros. that references Respondent's validation of the Company's inventions.

C. Lastly, the Company re-alleges the misfeasance of Respondent in light of his failure to file a copyright with the Unites States Library of Congress pertaining to the protection of the source code algorithmically enabling the Company's inventions, the drafting of which was billed for by Mr. Wheeler's office of Proskauer, although said office, to the best of the Company's knowledge, employed no intellectual property attorneys.

X. DR 7-102 [§1200.33] Representing a Client Within the Bounds of the Law.

A. The Company re-alleges and incorporates by this reference herein, as though fully set forth, Section I Subsection A-D, Section II Subsection A-C, Section III Subsection A, Section IV Subsection A-C, Section V Subsection A-D, and Section VI Subsection A, Section VII Subsection A-C, Section VIII Subsection A-C, and Section IX Subsection A-C, inclusive. Moreover, the Company further re-alleges that Respondent concealed and knowingly: (I) failed to disclose that which Respondent was required by law to disclose;



Thomas J. Cahill, Esq.
7/2/2003
Page 23

(II) spoke falsehoods and presented false documents; (III) made false statement of law and fact; (IV) participated, under the supervision of and with Mr. Joao, who was recruited by Respondent to assist, the Company alleges, in the burying the Company's invention, in the creation or preservation of documentation when Respondent knew that said documentation is false; (V) under the supervision of and with Mr. Joao had perpetrated a fraud upon a tribunal, the USPTO, without revealing the fraud to such tribunal; and (V) engaged in illegal conduct and conduct contrary to Disciplinary Rules.

B. More specifically, the Company re-alleges that Respondent, who is desirous of maintaining Respondent's personal financial gains, esteem, probable gains to Respondent's employer, Proskauer, other gains from representing a soon to be trillion dollar technology in MPEG 2, and clients from the multimedia patent pools and has recruited Mr. Joao to assist, the Company alleges, in the burying the Company's inventions, and perhaps the facts of the matter, cross-currently, see Mr. Utley, Mr. Wheeler, and Crossbow preparing for burying the Company itself, knowingly failed to disclose that which Respondent was required by law to disclose, in the allegedly burying of the Company's inventions, and perhaps the facts of the matter, cross-currently, see Mr. Utley, Mr. Wheeler, and Crossbow preparing for burying the Company itself.

Moreover, the Company re-alleges that Respondent knowingly spoke falsehoods and presented false documents, in investor and potential licensee discussions while representing the Company as the ultimate responsible party in the Company's patent prosecution process, and especially in those certain discussions with the Company's "seed" investor, an affiliate of Huizenga Holdings, Inc., as further described in Section II Subsection A, and Warner Bros. as further described in Section IX Subsection C, as well as other clients.

C. Furthermore, the Company further re-alleges that Respondent made false statement of law and fact, and as to fact in his discussions with investors and potential license partners, particularly, including but not limited to, an affiliate of Huizenga Holdings, Inc., Warner Bros., Crossbow Ventures, and through others, SONY Corporation, and as particularly described herein.

D. Additionally, the Company further alleges that Respondent participated, under the supervision of and with Mr. Joao, who was recruited by Respondent to assist, the Company alleges, in the burying the Company's invention, in the creation or preservation of documentation when Respondent knew that said documentation is false, as particularly described in [Exhibit B](#) attached herein, the complaint, response, and the Company's rebuttal of Raymond A. Joao, Esq.

E. Lastly, the Company further alleges that Respondent according to the supervision of and with Mr. Joao and attorneys of Foley & Lardner had perpetrated a fraud upon a



Thomas J. Cahill, Esq.
7/2/2003
Page 24

tribunal, the USPTO, via principles of *respondeat superior* and vicarious liability, without revealing the fraud to such tribunal. Finally, as evidenced by this Section, subsection B-E, inclusive, the Company re-alleges that Respondent engaged in illegal conduct and conduct contrary to Disciplinary Rules

XI. DR 9-102 [§1200.46] Preserving Identity of Funds and Property of Others; Fiduciary Responsibility; Commingling and Misappropriation of Client Funds or Property; Maintenance of Bank Accounts; Record Keeping; Examination of Records.

A. The Company re-alleges and incorporates by this reference herein, as though fully set forth, Section I Subsection A-D, Section II Subsection A-C, Section III Subsection A, Section IV Subsection A-C, Section V Subsection A-D, and Section VI Subsection A, Section VII Subsection A-C, Section VIII Subsection A-C, and Section IX Subsection A-C, and Section X Subsection A-E, inclusive. Furthermore, the Company alleges that Respondent failed to maintain required bookkeeping records for the seven (7) year period including, but not limited to copies of all bills that Respondent, who is desirous of maintaining Respondent's personal financial gains, esteem, probable gains to Respondent's employer, Proskauer, other gains from representing a soon to be trillion dollar technology in MPEG 2, and clients from the multimedia patent pools and has recruited Mr. Joao to assist, the Company alleges, in the burying the Company's inventions, should have rendered to the Company. Moreover, in representation of the Company, Respondent acknowledges³⁹ that he neither kept no notes, electronic mail messages, nor other records in his deposition with regard to the Litigation, wherein such Litigation is wholly irrelevant to the Complaint, but is instructive for these purposes, and said acknowledgement is attached herein as [Exhibit P](#).

Moreover, and upon request by subsequent patent counsel, Foley & Lardner, a copy of which is attached herein as [Exhibit P](#), Respondent failed, under principles of *respondeat superior* and vicarious liability, to require his charge, Mr. Joao to remit all documents required under Exhibit P, and not least of all, documentation Mr. Joao, by admission, destroyed, as further evidenced by Exhibit P.

Lastly, as previously described in Section V Subsection A above, in his response, Respondent points to the fact that he has not billed for one hour of work in representation of the Company, whereby by [Exhibit K](#), the Company finds itself asking "Does Respondent work for free?" and answers by replying "No, but only when Respondent, who is desirous of maintaining Respondent's personal financial gains, esteem, probable gains to Respondent's employer, Proskauer, other gains from representing a soon to be trillion dollar technology in MPEG 2, and clients from the multimedia patent pools and

³⁹ Supra Note 2 at 24, 26.



Thomas J. Cahill, Esq.
7/2/2003
Page 25

has recruited Mr. Joao to assist, the Company alleges, in the burying the Company's inventions, and perhaps the facts of the matter, cross-currently, see Mr. Utley, Mr. Wheeler, and Crossbow preparing for burying the Company itself, as a means to cloak his involvement in the burying of the Company's inventions."

XII. Lastly, the negligent actions of Respondent resulted in and were the proximate cause of loss to the Company.

A. The history of the Company, literally back to the first day of discovery of the inventions, sees the allegations described in Defendant's Motion for Leave to Amend to Assert Counterclaim for Damages, Proskauer Rose LLP v. Iviewit.com, Inc. et. al., Case No. CA 01-04671 AB (Circuit Court of the 15th Judicial Circuit in and for Palm Beach County, Florida filed May 2, 2001) attached herein as [Exhibit Q](#), a motion of which stems from that certain Litigation that is wholly irrelevant to this Complaint, but is instructive for the alleged violations I to XI above, wherein after review by the Company's subsequent patents counsels, the work product of Mr. Joao, under the supervision of Respondent, under the principles of *respondeat superior* and vicarious liability, who is desirous of maintaining Respondent's personal financial gains, esteem, probable gains to Respondent's employer, Proskauer, other gains from representing a soon to be trillion dollar technology in MPEG 2, and clients from the multimedia patent pools and has recruited Mr. Joao to assist, the Company alleges, in the burying the Company's inventions, and perhaps the facts of the matter, cross-currently, see Mr. Utley, Mr. Wheeler, and Crossbow preparing for burying the Company itself, result in the causing of damages to the Company over a twenty year patent life, as described in the Company's projections across all distribution channels as evidenced by [Exhibit R](#) attached herein projected at a present value of approximately Ten Billion Dollars (\$10,000,000,000) of potential damages, and much in the way Respondent, the Company alleges, envisioned.

The Company further alleges that, once Respondent and Mr. Joao saw the Company's inventions, Respondent sees the personal, financial need to bury these inventions, and recruits Mr. Joao as the executioner of the Company's inventions. Moreover, the Company's inventions, while certainly not end to end solutions are literally the backbone technology of, including but not limited to, MPEG and DVD, pose formidable competitive threats to those pools as graphically portrayed by [Exhibit S](#), and certainly pose a threat, by this one example, to Respondent's fee of \$8,500 per essential patent; Respondent counts among his clients both licensors (Alcatel) and licensees (Alcatel, C-Cube Microsystems, Divicom a unit of Harmonic) of MPEG evidenced by comparing his biography at http://www.proskauer.com/lawyers_at_proskauer/atty_data/4747 with MPEG LA licensors and licensees at <http://www.mpegla.com/>.

Moreover, in his response, Respondent relies upon the testimony of certain individuals, including, but not limited to Mr. Wheeler, Mr. Utley, Mr. Raymond T. Hersh, the former



Thomas J. Cahill, Esq.
7/2/2003
Page 26

Chief Financial Officer of the Company, and Gerald Lewin, a principal in the accounting firm of Goldstein Lewin & Company of Boca Raton, Fla. and the Company's former outside C.P.A. firm.

Furthermore, as to Mr. Wheeler, and wherein he states in his deposition that stems from that certain Litigation that is wholly irrelevant to this Complaint, but is instructive for these purposes, that Respondent did not perform any patent work or patent oversight work,⁴⁰ then in another instance Mr. Wheeler states that he contacts Respondent to determine what Respondent needs to determine the patentability of the Company's inventions,⁴¹ as evidenced by [Exhibit T](#) attached herein, and referencing Mr. Wheeler's letter to a one Richard Rossman also contained in Exhibit T. Additionally, in his Florida Bar response, Mr. Wheeler, while he admits of limited instances of consulting Respondent, is found consulting Respondent who fervently has claimed that "The only thing I did for Iviewit is I referred them to another patent lawyer⁴²."

Thus, First Judicial Department Departmental Disciplinary Committee should note that the reliance in any of Respondent's filings, and/or proceedings in this matter, on the testimony of Mr. Wheeler that would seemingly exculpate Respondent, by the above declaration it is clear that the testimony of Mr. Wheeler is worthless.

Additionally, as to Mr. Utley, and wherein he states in his deposition, *inter alia*, that stems from that certain Litigation that is wholly irrelevant to this Complaint, but is instructive for these purposes, at one instance that he had no discussions with Respondent pertaining to the Company's intellectual property⁴³, and then in another instance states that he had conversations with Respondent to apprise him of the status of the Company's patent prosecution process relative to a proposed contract with Warner Bros.,⁴⁴ as evidenced by [Exhibit U](#) attached herein.

Thus, First Judicial Department Departmental Disciplinary Committee should note that the reliance in any of Respondent's filings, and/or proceedings in this matter, on the testimony of Mr. Utley that would seemingly exculpate Respondent, by the above inconsistencies, it is clear that the testimony of Mr. Utley is worthless.

Furthermore, the Company references the testimony of Raymond T. Hersh, former Chief Financial Officer of the Company stating the satisfaction of the Company with the

⁴⁰ *Supra* Note 17 at 24-25.

⁴¹ *Supra* Note 17 at 36-38.

⁴² *Supra* Note 1.

⁴³ Deposition of Brian G. Utley at 140-141, *Proskauer Rose LLP v. Iviewit.com, Inc. et. al. Case No. CA 01-04671 AB (Circuit Court of the 15th Judicial Circuit in and for Palm Beach County, Florida filed May 2, 2001)*.

⁴⁴ *Supra* Note 22 at 175-176.



Thomas J. Cahill, Esq.
7/8/2003
Page 27

services of Proskauer⁴⁵. However, sometime before, and during Mr. Hersh's tenure with the Company, we reference an electronic mail message from a one William R. Kasser, a former accounting consultant of the Company to Eliot Bernstein, wherein Mr. Kasser, as a result of an account reconciliation, alleges gross fraud in the booking of Company revenues by Mr. Hersh and Mr. Utley, as evidenced by [Exhibit V](#) attached herein.

Thus, First Judicial Department Departmental Disciplinary Committee should note that the reliance in any of Respondent's filings, and/or proceedings in this matter, on the testimony of Mr. Hersh that would seemingly exculpate Respondent, by the above declaration it is clear that the testimony of Mr. Hersh is worthless.

Additionally, the allegations surrounding the representation of Proskauer, through Respondent and Mr. Wheeler, finds support in the many pieces of evidence portrayed in Section I through XII, and the Complaint will still be better served by enlisting the participation of First Judicial Department Departmental Disciplinary Committee in securing the following items: (I) records of Proskauer records to determine the whereabouts of Respondent from the period of mid 1998 to February 1999; (II) records of MLGS, cross referencing the records of Proskauer to determine the whereabouts of Respondent from the period of mid 1998 to February 1999; and (III) an explanation and the series of events that led up to the referral of Mr. Joao by Respondent.

Lastly, in the near future, the Company intends to: (I) file a claim with the Lawyers' Fund for Client Protection as a result of the alleged dishonest conduct in the taking of the Company's property, to wit, the irresponsible filing of provisional and non-provisional patent applications under the supervision of Respondent; (II) fulfill its requirement to report the loss of property to an Attorney Disciplinary (Grievance) Committee; and (III) fulfill its requirement to submit a written statement to the District Attorney of New York County.

Finally, the Company attaches a witness list, as [Appendix I](#), that contains individual names, addresses, and telephone numbers, all of which shall attest to Respondent's, who is desirous of maintaining Respondent's personal financial gains, esteem, probable gains to Respondent's employer, Proskauer, other gains from representing a soon to be trillion dollar technology in MPEG 2, and clients from the multimedia patent pools and has recruited Mr. Joao to assist, the Company alleges, in the burying the Company's inventions, and perhaps the facts of the matter, cross-currently, see Mr. Utley, Mr. Wheeler, and Crossbow preparing for burying the Company itself, engagement in a series of dishonesties, appearances of untrustworthiness, conduct involving dishonesty, fraud,

⁴⁵ Deposition of Raymond Hersh at 33-34, *Proskauer Rose LLP v. Iviewit.com, Inc. et. al. Case No. CA 01-04671 AB (Circuit Court of the 15th Judicial Circuit in and for Palm Beach County, Florida filed May 2, 2001)*.



Thomas J. Cahill, Esq.
7/8/2003
Page 28

deceit, and misrepresentation as now conclusively shown by Section I through Section XII, supra, in general, and by Section I Subsection D. paragraphs 1 to 14, in particular wherein Respondent dishonorably found the need to disavow, *inter alia*: any knowledge whatsoever of the Company; any knowledge whatsoever of Mr. Bernstein and the other true inventors; any knowledge whatsoever of techniques known as pan and zoom technology; and through his refusal to answer questions regarding the allegedly vicariously liable MPEG LA, LLC amongst others; his charge that the deposition was harassment in that he had nothing to do with the Company; his steadfast denial of technology known as scaled video; his claim as to never opining on the Company's technology; his denial of ever having been involved in meetings concerning the Company; his denial of ever having any discussion with anyone at Proskauer concerning the Company's technology; his admission of not keeping notes or records of his conversations to Mr. Wheeler; his acknowledgement of never having billed the Company, though his name appears more than a dozen times, absent those billings that may have purposely removed, in billings from Mr. Wheeler's office; his denial of making any representations to any party with regard to the Company's technologies; his stunning reversal of his possible conversation with third parties regarding the Company's technologies; and, his lack of knowledge as to why his name appears in an electronic mail message to a member of AOL Time Warner's investment team, wherein that message states that Respondent opined on the Company's technologies; the facts of the matter, Mr. Cahill, when bolstered by Exhibits A through V attached herein, and matched against Respondent's above referenced disavowals, are clearly beyond dispute.

Sincerely,

IVIEWIT HOLDINGS, INC.

By: P. Stephen Lamont by Eliot I. Bernstein his attorney-in-fact

A handwritten signature in black ink, appearing to be "P. Stephen Lamont".

P. Stephen Lamont
Chief Executive Officer (Acting)

A handwritten signature in black ink, appearing to be "Eliot I. Bernstein".

By:

Eliot I. Bernstein
President & Founder (Acting)

Eliot I Bernstein

From: P. Stephen Lamont [pstephen.lamont@verizon.net]
Sent: Tuesday, July 08, 2003 9:22 AM
To: Eliot I. Bernstein (E-mail)
Subject: Limited Power of Attorney

LIMITED POWER OF ATTORNEY

I. PARTIES. I, P. Stephen Lamont ("Principal"), with a principal address of Four Ward Street, Brewster, New York hereby appoint Eliot I. Bernstein ("Attorney-in-Fact") with a principal address of 10158 Stonehenge Circle, Boynton Beach, Fla. and telephone number of 561=364=4240 as attorney-in-fact to represent me in affairs consisting only of those powers listed in Section II herein.

II. POWERS.

1. Execution of Signature Page for Iviewit Rebuttal to Rubenstein

III. DURATION. Said Attorney-in-Fact shall, subject to revocation in writing, have authority to conduct items one (1) above and perform on behalf of Principal: All acts necessary and requisite to facilitate said functions and/or proceedings from the period July 8, 2003 through July 11, 2003 ("Duration").

IV. OTHER ACTS.

1. None.

V. MISCELLANEOUS.

1. NOTICES. Copies of notices and other written communications addressed to the Principal in proceedings involving the above matters should be sent to the address set forth above.

2. CONFORMANCE TO STATE LAW. It is the intention of the parties that this Limited Power of Attorney conform to the laws of the State of New York, and should any section of this Limited Power of Attorney not conform to the laws of the State of New York, it is the intention of the parties that said section(s) be substituted for that section that would otherwise conform to the laws of the State of New York. Should the laws of the State of New York require any other section(s) other than the sections of this Limited Power of Attorney, it is the intention of the parties, that said section(s) be construed to be included in this Limited Power of Attorney, as if said sections were included herein.

3. NO PRIOR POWERS. This Limited Power of Attorney revokes all prior powers of attorney by and between Principal and Attorney-in-Fact with respect to the same matters and years or periods covered by this instrument.

Best regards,

P. Stephen Lamont
Chief Executive Officer
Iviewit Holdings, Inc.
10158 Stonehenge Circle
Boynton Beach, Fla. 33437
Tel.: 914-217-0038
Email: pstephen.lamont@verizon.net; 9142170038@mobile.att.net
URL: www.iviewit.com

THIS MESSAGE AND ITS EMBEDDED AND/OR ATTACHED FILES INCORPORATED HEREIN BY REFERENCE CONTAIN INFORMATION THAT IS PROPRIETARY AND CONFIDENTIAL, PRIVILEGED INFORMATION. IF YOU ARE NOT THE INTENDED RECIPIENT, YOU ARE PROHIBITED FROM READING, OPENING, PRINTING, COPYING, FORWARDING, OR SAVING THIS MAIL AND ITS EMBEDDED AND/OR ATTACHED FILES. PLEASE DELETE THE MESSAGE AND ITS EMBEDDED AND/OR ATTACHED FILES WITHOUT READING, OPENING, PRINTING, COPYING, FORWARDING, OR SAVING THEM, AND NOTIFY THE SENDER IMMEDIATELY AT 561.364.4240. IF YOU ARE THE INTENDED RECIPIENT, YOU ARE PROHIBITED FROM FORWARDING THEM OR OTHERWISE DISCLOSING THESE CONTENTS TO OTHERS, WITHOUT THE EXPRESS WRITTEN CONSENT OF THE SENDER.

Incoming mail is certified Virus Free.

SENATE SUMMARY

Creates the "Computer Crimes Control Act." Prohibits unlawful tampering with, interference to, damage to, or unauthorized access to computers, computer systems, and computer data. Specifies the penalties to be imposed for the offense of computer interference. Provides that a person convicted of committing computer interference is subject to civil damages. Provides for attorney's fees. Requires colleges and universities to include computer-related crime as a violation of rules governing student conduct. Provides for the forfeiture of property used in connection with an offense of computer interference. Provides that a person may be convicted of the offense of computer interference in multiple jurisdictions. (See bill for details.)

Checked by AVG anti-virus system (<http://www.grisoft.com>).
Version: 6.0.497 / Virus Database: 296 - Release Date: 7/4/2003



EXHIBIT A

1

2

3 IN THE CIRCUIT COURT OF THE
4 15th JUDICIAL CIRCUIT IN AND
5 FOR PALM BEACH COUNTY, FLORIDA

6 -----X

7 PROSKAUER ROSE L.L.P.,

8 Plaintiff,

9 vs. CA 01-04671 AB

10 IVIEWIT.COM, INC., a Delaware
11 corporation, IVIEWIT HOLDINGS,
12 INC., a Delaware corporation,
13 and IVIEWIT TECHNOLOGIES,
14 INC., a Delaware corporation,

15 Defendants.

16 -----X

17

18

19

20 DEPOSITION OF KENNETH RUBENSTEIN

21 New York, New York

22 Wednesday, November 20, 2002

23

24

25

26 Reported by:
27 WENDY D. BOSKIND, RPR
28 Job No. 142586

29

□

Ken Rubenstein Deposition

2
3
4
5
6
7
8
9
10
11
12
13
14
15
16
17
18
19
20
21
22
23
24
25

November 20, 2002
11:06 a.m.

Deposition of KENNETH RUBENSTEIN,
held at the offices of Proskauer Rose
LLP, 1585 Broadway, New York, New York,
pursuant to Notice and Agreement,
telephonically pursuant to a Court
Order, before Wendy D. Boskind, a
Registered Professional Reporter and
Notary Public of the State of New York.

□

3

1
2
3
4

A P P E A R A N C E S :

PROSKAUER ROSE LLP

5 Ken Rubenstein Deposition
Attorneys for Plaintiff
6 2255 Glades Road
7 Suite 340 West
8 Boca Raton, Florida 33431-7360
9 BY: CHRISTOPHER W. PRUSASKI, ESQ.

10
11
12 SELZ & MUVDI SELZ, P.A.
13 Attorneys for Defendants
14 214 Brazilian Avenue
15 Suite 220
16 Palm Beach, Florida 33480
17 BY: STEVEN M. SELZ, ESQ.
18 (telephonically)

19
20
21 ALSO PRESENT:
22 ELIOT BERNSTEIN, ESQ.
23 (telephonically)

24
25
1
2 K E N N E T H R U B E N S T E I N ,
3 business address at Proskauer Rose
4 LLP, 1585 Broadway, New York, New York,
5 having first affirmed before the Notary
6 Public, (Wendy D. Boskind), was examined
7 and testified as follows:

□

Ken Rubenstein Deposition

8

9 EXAMINATION BY

10 MR. SELZ:

11 Q. Mr. Rubenstein, my name is
12 Attorney Steve Selz, I represent the
13 Defendants in the case of Proskauer Rose
14 versus IViewIt.com.

15 I am going to ask you a series of
16 questions in this deposition, and the first
17 thing I need to know is whether or not you
18 have had your deposition taken previously.

19 A. I have had my deposition taken
20 previously.

21 Q. On how many occasions has that
22 taken place, sir?

23 A. Several.

24 Q. "Several", more than a dozen?

25 A. No.

□

5

1 Rubenstein

2 Q. More than five?

3 A. No.

4 Q. Can you give me an approximate
5 number? Two or three?

6 A. I would say three or four.

7 Q. Okay, three or four. So you are
8 familiar with the way a deposition works; is
9 that correct, sir?

10 A. Yes.

11 Q. So if I ask you a question, unless
12 you ask me to rephrase it or somehow revise
13 the structure of the question, I will presume
14 then that you have understood what I have
15 asked you as it is posed.

16 A. If I think your question is of
17 improper form, unclear, or harassment, I am
18 going to object.

19 Q. Okay, I believe that would be not
20 for you to do but Mr. Prusaski, as your
21 counsel.

22 A. I will put any objection I want on
23 the record, in addition to Mr. Prusaski.

24 Q. So, you are representing yourself?

25 A. No, I am not, he is representing

□

6

1 Rubenstein
2 me, but I am going to put objections on the
3 record, if I want to.

4 Q. That's fine.

5 Now, starting off with, sir, could
6 you please state your full name?

7 A. Kenneth Rubenstein.

8 Q. "Kenneth Rubenstein." And where
9 is your place of employment currently,
10 Mr. Rubenstein?

11 A. Proskauer Rose.

12 Q. Where is that located?

13 A. 1585 Broadway, New York.

14 Q. And how long have you been
15 employed with Proskauer Rose?
16 A. About four, four-and-a-half years.
17 Q. Somewhere between 1997 and 1998
18 was your first date of employment?
19 A. I think it was in 1998.
20 Q. Do you remember a month?
21 A. Possibly June.
22 Q. June. Where were you employed
23 prior to your employment with Proskauer Rose?
24 A. I was with a law firm, Meltzer,
25 M-E-L-T-Z-E-R, Lippe, L-I-P-P-E.

□

7

1 Rubenstein
2 Q. Meltzer Lippe is located where?
3 A. Mineola, New York.
4 Q. Do you have an address that you
5 can recall?
6 A. On Willis Avenue, but I don't have
7 the address right now.
8 Q. Prior to Meltzer Lippe -- and
9 approximately what were the dates of your
10 employment at Meltzer Lippe?
11 A. About 1993 to 1998.
12 Q. And what did you do at Meltzer
13 Lippe?
14 A. I was an attorney.
15 Q. Did you have any specialization?
16 A. I was a patent attorney.

- 17 Q. Are you still a patent attorney?
18 A. Yes.
19 Q. Is that your role at Proskauer
20 Rose currently, is a patent attorney?
21 A. Yes.
22 Q. Are you a partner of Proskauer
23 Rose?
24 A. Yes.
25 Q. Are you a shareholder of Proskauer

□

8

- 1 Rubenstein
2 Rose?
3 A. One or the other, either partner
4 or shareholder.
5 I think it's a partnership.
6 Q. It's a partnership. Do you have
7 any ownership interest in the partnership in
8 the sense of obligations that go beyond what
9 some of the other partners have? In other
10 words, do you have an equity share? Do you
11 have any other claims with regard to an
12 interest in Proskauer Rose?
13 A. I have no idea.
14 Q. Prior to Meltzer Lippe, where were
15 you employed, sir?
16 A. Another law firm.
17 Q. Do you remember the name of that
18 law firm?
19 A. Marmorek, M-A-R-M-O-R-E-K,

Ken Rubenstein Deposition
20 Guttman, G-U-T-T-M-A-N, & Rubenstein.

21 Q. Were you the "Rubenstein" in the
22 name of the firm?

23 A. Yes.

24 Q. And you were a partner in that
25 firm?

9

1 Rubenstein

2 A. Yes.

3 Q. What were the dates of your
4 employment in that firm --

5 A. Oh --

6 Q. -- Marmorek Guttman & Rubenstein.

7 A. -- probably starting in the
8 Eighties, mid-Eighties, until 1993.

9 Q. And what was the area of your
10 practice, when you were with Marmorek --

11 A. M-A-R-M-O-R-E-K.

12 Patent law.

13 Q. Patent law. And your dates -- you
14 say you left Marmorek Guttman & Rubenstein and
15 went to Meltzer Lippe and then to Proskauer
16 Rose, but at all times you were a patent
17 lawyer --

18 A. Yes.

19 Q. -- is that a correct statement?

20 A. Yes.

21 Q. Is that a correct statement, sir?

22 A. Yes.

23 Q. You have to wait until I finish
Page 8

Ken Rubenstein Deposition

24 the question.

25 A. No, you are not getting the

□

10

1 Rubenstein

2 answers clearly in your head. You should take
3 better notes.

4 MR. SELZ: Move to strike as
5 non-responsive.

6 (MOTION TO STRIKE.)

7 A. That's fine, move to strike it.

8 Q. Sir, during that entire period of
9 time, then, you were a patent lawyer; is that
10 a correct statement of fact?

11 A. Yes.

12 Q. Are you familiar with something
13 that's called "pan and zoom technology"?

14 A. I am not sure what you mean by
15 that.

16 Q. Well, let me start very simply,
17 and say this. Are you familiar with a concept
18 that an image can be enlarged while being
19 transmitted on a narrow bandwidth?

20 A. I don't know what you are talking
21 about.

22 Q. Okay. Well, let me go back to
23 this, then, sir. Are you familiar at all with
24 the technology involved with IViewIt.com?

25 A. No.

1 Rubenstein

2 Q. Do you have any information at all
3 with regard to any of the IViewIt entities?

4 A. Not at this time, no.

5 Q. "Not at this time." Did you have
6 any information at any time in the past, sir?

7 A. Not that I know of right now.

8 Q. Do you have any files or records
9 indicating that you had any dealings with --
10 and I will go through a list here --
11 IViewIt.com, Inc.?

12 A. Not that I know of.

13 Q. IViewIt, LLC?

14 A. Not that I know of.

15 Q. UViewIt?

16 A. Not that I know of.

17 Q. IViewIt, Inc.?

18 A. Not that I know of.

19 Q. Have you ever heard of an
20 individual named Eliot Bernstein?

21 A. I might have.

22 Q. Well, sir, that's either a "Yes"
23 or "No" question.

24 A. Like I said, I think he works for
25 IViewIt, and I may have heard his name.

Ken Rubenstein Deposition
Rubenstein

1

2 Q. How about what is called the MPEG
3 Patent Pool, have you heard of that?

4 A. Yes, I have.

5 Q. Why don't you tell me what that
6 is.

7 A. Decline to answer at this time.

8 Q. Why do you decline to answer?

9 A. Irrelevant to this deposition.

10 Q. I'm sorry, irrelevancy is not an
11 objection that would allow you not to answer,
12 sir.

13 A. Make a motion to the judge. If he
14 orders me to tell you about it, I will tell
15 you.

16 MR. SELZ: Chris, are you
17 instructing your client not to answer?

18 MR. PRUSASKI: I am going to put
19 an question for relevancy based on the
20 court's granting of the motion and
21 limiting on the record, and if
22 Mr. Rubenstein declines to answer then
23 he is declining to answer.

24 And, just so I don't have to keep
25 objecting, Mr. Selz, to make this

□

13

1

Rubenstein

2 easier, my objection is continuing in
3 nature as to any questions regarding any

4 Ken Rubenstein Deposition
5 transactions for IViewIt that you are
6 going to ask Mr. Rubenstein if he was
7 involved in based on the court's
8 granting of the motion and limiting.

8 MR. SELZ: Let me go on the record
9 and say the discovery documents that
10 have been produced by the Defendants --
11 Plaintiff in this matter indicate
12 various dealings in which Proskauer Rose
13 was affiliated including dealings with
14 H. Wayne Huizenga, CrossBow Ventures,
15 Wachovia, a number of other entities
16 which are part of the discovery and have
17 been produced by the Plaintiffs pursuant
18 to a valid request for production, so to
19 the extent you are claiming it's subject
20 to any motion and limited, that's fine
21 with regard to the trial, and the
22 discovery you produced on your own
23 pursuant to a request for production
24 which has not been held invalid includes
25 these very matters.

□

14

1 Rubenstein
2 A. So why don't you tell me more
3 particularly what you want to know.

4 MR. PRUSASKI: Mr. Selz, let me
5 just respond to that.

6 There were never any affirmative

7 Ken Rubenstein Deposition
8 defenses asserted by the Defendants in
9 this matter that have anything to do
10 with particular transactions, the
11 defenses involved whether the bills
12 were --

13 MR. SELZ: Let's go --

14 MR. PRUSASKI: I get to finish
15 because --

16 MR. SELZ: Go ahead and finish.

17 MR. PRUSASKI: Thank you.

18 There were never any affirmative
19 defenses asserted by the Defendants in
20 this matter relating to anything other
21 than the amount of the bills. And, so,
22 to the extent that the court granted our
23 motion limiting it, the Defendants can't
24 put any evidence of any particular
25 transactions or alleged wrongdoing by
Proskauer on at trial, but to that

□

15

1 Rubenstein
2 extent I am going to ask Mr. Rubenstein
3 to answer your questions. If I feel
4 that they are becoming overreaching, I
5 will make -- or if you are extending too
6 far into what I think is a violation of
7 the court's granting of the motion of
8 limiting, I will make another objection.

9 MR. SELZ: And let me go on the

10 Ken Rubenstein Deposition
11 record, the motion of limiting is fine
12 with regard to anything presented at
13 trial. It certainly does not preclude
14 the scope of discovery from including,
15 in a deposition, questions which may
16 lead to discoverable evidence concerning
17 the bills and the services that were
18 provided, which is the basis for the
19 affirmative defenses.

19 MR. PRUSASKI: And I am aware that
20 you have some latitude with respect to
21 discovery under the rules.

22 MR. SELZ: And I think we have
23 pretty significant latitude under the
24 rules.

25 And with regard to your client,

□

16

1 Rubenstein
2 Mr. Rubenstein, indicating he is
3 refusing to answer, I believe you should
4 instruct him right now, under Florida
5 law, he doesn't have the right to refuse
6 to answer.

7 A. All right, I will answer the
8 question.

9 MR. PRUSASKI: I just said a
10 minute ago we will go ahead.

11 A. Anything you want to know about
12 the MPEGLA patent pool, that's public

13 information, it's is on a web site,
14 MPEGLA.com. You should go look at that
15 web site. Any public information that I am
16 entitled to tell you is on that web site.

17 Q. Well, I am going to ask you, sir,
18 in this deposition to give me that
19 information.

20 A. And I am just telling you to go
21 look at the web site.

22 MR. SELZ: Let the record show the
23 witness is refusing to respond to a
24 direct question.

25 A. That is an incorrect

□

17

1 Rubenstein
2 characterization of the record.

3 The record shows that I told you a
4 place where you can get the answer very
5 easily. There is no reason for you to make me
6 sit here and waste my time repeating to you
7 things you can easily read about.

8 Q. Well, sir, this is your testimony
9 at your deposition.

10 A. That's right, which you are making
11 me do. I consider the deposition nothing but
12 harassment, considering that I had nothing to
13 do with the company. It's just a form of
14 harassment.

15 You go read the web site, if you

16 want to know about it.

17 Q. Okay, so you are refusing to
18 answer?

19 A. I am not refusing.

20 Q. Other than advising me to go to a
21 web site --

22 A. I am not refusing to answer. I
23 did answer. Please stop characterizing my
24 testimony. I told you the answer. I told you
25 all publicly-available information about the

□

18

1 Rubenstein

2 MPEG patent pool can be found at
3 www.MPEGLA.com. You are free to go read it.
4 Please go read it and you will learn all you
5 need to know about it.

6 Q. So you are not going to tell me
7 what the "MPEG patent pool" is?

8 A. I told you you could go read it.

9 Q. Okay.

10 MR. SELZ: Chris, do you want to
11 instruct your witness, or deponent, or
12 client, at all in that matter?

13 MR. PRUSASKI: Do you have any
14 specific questions with respect to
15 IViewIt in the MPEG patent pool?

16 MR. SELZ: Yes.

17 A. All right, so why don't you ask me
18 those questions.

Ken Rubenstein Deposition

19 MR. SELZ: I want Mr. Rubenstein
20 to first explain to me what the "MPEG
21 patent pool" is, and then I will ask him
22 questions concerning exactly how it
23 relates to IViewIt.
24 In other words --
25 A. Okay, I will answer both your

□

19

1 Rubenstein
2 questions.
3 Q. Go ahead.
4 A. The "MPEG patent pool" is a
5 collection of patents owned by a group of
6 companies related to the MPEG 2 video
7 compression standard and, as far as I know, it
8 has nothing whatsoever to do with IViewIt.
9 Q. So it has no technology -- the
10 MPEG patent pool uses no technology in any way
11 related to any of the IViewIt entities or
12 their intellectual properties; is that your
13 testimony?
14 A. No, it's not my testimony.
15 Q. Okay.
16 A. My testimony is, it's a group of
17 patents chosen according to very specific
18 criteria related to the MPEG 2 standard and,
19 to my knowledge, has nothing to do with
20 IViewIt.
21 And please do not characterize my

22 words. Please do not rephrase them. If you
23 don't know what I said, you can ask the
24 reporter to read it back. But do not
25 characterize my testimony.

□

20

1 Rubenstein

2 MR. SELZ: Again, let the record
3 reflect the deponent is not being
4 responsive.

5 A. I am being very responsive.
6 Please stop characterizing my testimony. And
7 please stop putting things on the record that
8 are incorrect.

9 Q. Mr. Rubenstein, I am asking you
10 questions, and I am asking --

11 A. And you are not listening to the
12 answers very carefully, so -- I don't know how
13 much experience you have taking depositions --

14 MR. SELZ: Again, let the record
15 reflect that --

16 A. Stop interrupting my answers. Do
17 not interrupt me.

18 Q. Mr. --

19 A. Do not interrupt me.

20 Q. Mr. Rubenstein --

21 A. Let me finish.

22 Are you going to proceed to
23 continue to interrupt me or not?

24 Q. If you want to answer the

Ken Rubenstein Deposition
25 questions, I have no problem.

□

21

1 Rubenstein

2 A. Look, I answered your questions.

3 You are unable to keep track of what I am

4 saying.

5 So, please, if you don't know what

6 I said, ask the reporter to read it back, but

7 please do not characterize my testimony in

8 your own words.

9 Q. Okay --

10 A. Just don't do it.

11 Q. What I am asking you is this. Do
12 any of the members of the MPEG patent pool use
13 any of the technologies of IViewIt?

14 A. I would have no idea.

15 Q. Who is the person in charge of the
16 MPEG patent pool, sir?

17 A. Like I say, I advise you to check
18 their web site if you want to know information
19 about that patent pool.

20 Q. Well, again --

21 A. It's not me.

22 Q. Are you involved with the MPEG
23 patent pool, sir?

24 A. Yes.

25 Q. What is your position --

□

22

Ken Rubenstein Deposition

1 Rubenstein

2 A. I am counsel to MPEG, LLC.

3 Q. Do you advise the MPEG patent pool
4 with regard to legal issues?

5 A. That's privileged information.

6 Q. Not whether or not you advised
7 them on legal issues.

8 A. You are asking me -- I am not
9 going to discuss with you anything about
10 anything I do with any other client in this
11 law firm.

12 Q. Well, sir, I am not asking you the
13 substance of what you have advised them, I am
14 simply asking you whether or not you advised
15 them.

16 A. I told you, I am their counsel.

17 Q. Okay. Have you ever seen any of
18 the intellectual properties or technologies
19 that IViewIt has developed for scaled video?

20 A. Not that I recall at this time.

21 Q. Were you ever involved in any
22 patent applications for scaled video
23 technologies for IViewIt.com?

24 A. No.

25 Q. Did you ever review any patent

□

23

1 Rubenstein

2 application at all for IViewIt --
Page 20

Ken Rubenstein Deposition

3 A. Not that I recall.

4 Q. Did you ever opine with regard to
5 the validity of any patent applied for or
6 received by IViewIt.com?

7 A. Like I say, I was not in any way
8 involved with getting patents for IViewIt.

9 Q. What were you involved with, if
10 you were, with IViewIt?

11 A. The only thing I did for IViewIt
12 is I referred them to another patent lawyer.

13 Q. And who is that?

14 A. A guy named Ray Joao.

15 Q. And where did Mr. Joao work?

16 A. I believe he was working at the
17 time at my former law firm, Meltzer Lippe.

18 Q. And what date was this?

19 A. I don't recall.

20 Q. So, you were employed by Proskauer
21 Rose at this time?

22 A. Yes.

23 Q. And you referred IViewIt to
24 Meltzer Lippe?

25 A. I referred IViewIt to Ray Joao,

□

24

1 Rubenstein
2 who I believe was working at Meltzer Lippe at
3 that time.

4 Q. Who did you speak to at IViewIt,
5 sir?

Ken Rubenstein Deposition

6 A. I don't recall.

7 Q. Did you keep any notes of your
8 conversation with regard to this referral?

9 A. No.

10 Q. Did you speak to Mr. Joao with
11 regard to this referral?

12 A. I don't recall.

13 Q. Why did you refer this matter to
14 Meltzer Lippe?

15 A. Because it wasn't work I wanted to
16 undertake myself.

17 Q. And why was that?

18 A. Because I am not generally in the
19 patent prosecution business, in most cases.

20 Q. Did you ever meet with any members
21 of the board of directors of IViewIt.com?

22 A. Not that I know of.

23 Q. Were you ever involved in any
24 meetings with anyone concerning IViewIt.com?

25 A. No, not that I know of.

□

25

1 Rubenstein

2 Q. How about any representative from
3 Real 3 D?

4 A. Never heard of it.

5 Q. How about Warner Bros.?

6 A. Warner Bros. is a client here.

7 Q. Okay. Did you have any
8 discussions with Warner Bros. about IViewIt?

Ken Rubenstein Deposition

9 MR. PRUSASKI: Objection.
10 A. Any --
11 MR. PRUSASKI: Instruct him not to
12 answer.
13 (DIRECTION NOT TO ANSWER.)
14 A. Any conversation I made or had
15 with Warner Bros. would be confidential. I am
16 not saying there was or was not such a
17 conversation, it would be privileged.
18 Q. I am not asking you for the
19 contents of the conversation, I want to know
20 if there was one.
21 A. I am not saying -- I don't know if
22 there was one.
23 And if there was, I wouldn't tell
24 you about it, anyway.
25 Q. How about Hollywood.com?

□

26

1 Rubenstein
2 A. Never heard of it.
3 Q. Did you ever have any discussions
4 with anyone at Proskauer Rose concerning the
5 IViewIt Technologies?
6 A. Not that I recall.
7 Q. Did you have any discussions with
8 anyone -- let's say Chris Wheeler,
9 particularly, at Proskauer Rose with regard to
10 anything at IViewIt?
11 A. I might have, but I don't recall

Ken Rubenstein Deposition

12 anything about it at this time, if I did.

13 Q. Did you ever counsel anyone at
14 IViewIt concerning any matters regarding the
15 patent or patent applications?

16 A. Not that I recall.

17 Q. Did you keep any files yourself
18 with regard to IViewIt and any communications
19 with IViewIt?

20 A. I don't think so, no.

21 MR. PRUSASKI: Objection, asked
22 and answered.

23 Q. Did you ever play a role as an
24 advisory board member for IViewIt?

25 A. Not that I know of, no.

□

27

1 Rubenstein

2 Q. Well, sir, I am a little
3 confused. You normally would recall that you
4 would be on a board of directors --

5 A. I don't think I was on any such
6 board.

7 To my knowledge, I was on no such
8 board.

9 Q. And you never had any
10 communications with any board member from
11 IViewIt; is that a correct characterization --

12 A. I had a -- probably a phone call
13 or two with Brian Utley. I am not sure if
14 he's a board member or not.

Ken Rubenstein Deposition

15 Q. And what were the contents of your
16 conversation with Mr. Utley?

17 A. I don't recall.

18 Q. Did you ever talk to anyone at
19 Warner Bros. with regard to IViewIt?

20 A. You are asking for privileged
21 information, sorry.

22 Q. Well, whether or not you had
23 communications --

24 A. No, you are asking for the content
25 of communications.

□

28

1 Rubenstein

2 Q. No, I am not asking for the
3 content.

4 A. Yes, you are.

5 Q. Please listen to my question.

6 MR. PRUSASKI: Mr. --

7 Q. The question was, did you ever
8 discuss any matters concerning IViewIt with
9 anyone from Warner Bros., period. I am not
10 asking you for the content because, clearly,
11 if you want to assert a claim of privilege on
12 that, and Warner Bros. is a client of yours,
13 then you can assert it, but I am asking you
14 whether or not you had any discussions at
15 all. I am not asking you for the contents.

16 A. I am --

17 MR. PRUSASKI: Mr. Selz, I am
Page 25

Ken Rubenstein Deposition

18 going to object. I am instructing
19 Mr. Rubenstein not to answer. It's
20 privileged attorney/client
21 communication.

22 (DIRECTION NOT TO ANSWER.)

23 MR. SELZ: Not the fact of whether
24 or not he had any discussions --

25 MR. PRUSASKI: I am not arguing.

□

29

1 Rubenstein
2 We are not allowed, under the Florida
3 rules, to argue objections. I am
4 instructing him not to answer.

5 MR. SELZ: I understand.

6 MR. PRUSASKI: And I can't argue
7 with you.

8 MR. SELZ: Just so the record is
9 clear, your objection is it's
10 privileged, whether or not he even spoke
11 to Warner Bros.

12 MR. PRUSASKI: Yes, about IViewIt.

13 MR. SELZ: About IViewIt.

14 MR. PRUSASKI: Yes.

15 Q. Do you know who Greg Thagard is?

16 A. Yes, I do.

17 Q. Who is he?

18 A. He used to work at Warner Bros.

19 Q. He doesn't work with Warner Bros.
20 anymore; is that correct?

Ken Rubenstein Deposition

21 A. Correct.
22 Q. When did you represent Warner
23 Bros., sir?
24 A. Oh, that's not -- that's
25 privileged information, sorry.

□

30

1 Rubenstein
2 MR. PRUSASKI: I am going to
3 object for relevancy, and instruct the
4 witness not to answer. It's also
5 privileged.
6 (DIRECTION NOT TO ANSWER.)
7 MR. SELZ: I don't think case law
8 supports the position that when he
9 represented a client --
10 MR. PRUSASKI: Are we going to
11 argue every time there is an objection?
12 MR. SELZ: No, no, no.
13 A. We will litigate out the issue.
14 We will litigate it out. You know, make a
15 motion. We will fight it. We will see who
16 wins.
17 Q. Mr. Rubenstein again, you know,
18 this is your deposition --
19 A. I don't --
20 Q. -- I appreciate the fact that you
21 want to express your opinion. However,
22 Mr. Prusaski can tell you, this is not how
23 depositions are conducted in the state of

Ken Rubenstein Deposition

24 Florida.

25 A. Fine. I am not discussing

□

31

1 Rubenstein
2 anything about Warner Bros. The objection has
3 been put on the record. Let's move on.

4 MR. PRUSASKI: And, Mr. Selz, just
5 to make it clear, I am going to instruct
6 the client not to answer any questions
7 about any Proskauer clients under claim
8 of privilege and under claim of
9 harassment and under claim of the fact
10 that you are not allowed to put any of
11 this on at trial.

12 MR. SELZ: Well --

13 MR. PRUSASKI: And we can litigate
14 that with Judge Labarga.

15 Q. Now, I am asking you specifically,
16 sir, with regard to any specific meetings, how
17 about Real 3 D?

18 A. I never heard of Real 3 D.

19 Q. You never heard of them, okay.
20 That's what I was going to say.

21 Are you aware of any meeting that
22 happened between yourself and any
23 representatives of IViewIt, other than you
24 have already described?

25 A. Not that I recall. I may have

□

1 Rubenstein
2 also had a conversation with Lamont, but I am
3 not sure.
4 Q. Lamont, you spoke to Stephen
5 Lamont?
6 A. Possibly, yes.
7 Q. And that was concerning IViewIt?
8 A. Maybe, yes.
9 Q. Do you recall what the contents of
10 that conversation were?
11 A. No.
12 Q. How about Zackirul Shirajee, do
13 you know who he is?
14 A. No.
15 Q. How about Jude Rosario?
16 A. Don't know who he is.
17 Q. How about any awareness on your
18 part of any IViewIt inventions regarding zoom
19 imaging?
20 A. I have no knowledge at this point
21 in time of IViewIt technology.
22 Q. So you have no knowledge of scaled
23 video?
24 A. I didn't say that. I said I have
25 no knowledge of what IViewIt technology is at

□

Ken Rubenstein Deposition
Rubenstein

1

2 this point in time.

3 Q. Okay, why don't you explain to me
4 "scaled video", to the best of your
5 knowledge.

6 A. I don't know what you mean by
7 "scaled video".

8 why don't you explain to me what
9 you are talking about.

10 Q. well, what does that mean to you?
11 You seemed to indicate earlier in your answer
12 that you had some idea of what I was talking
13 about.

14 A. well, "scaled video" might refer
15 to changing the sizes of video images.

16 Q. And how is that accomplished?

17 A. I don't know. At this point in
18 time, I am sure there is a variety of
19 techniques to do it.

20 Q. Are you aware of any such
21 techniques that IViewIt was using?

22 A. No.

23 Q. Are you aware of any camera zoom
24 applications used in the IViewIt technology?

25 A. No.

□

34

1 Rubenstein

2 Q. How about combined scaled video
3 zooming video applications?

Ken Rubenstein Deposition

4 A. Not that I know of.
5 I am not saying they don't or do
6 exist, I am saying I don't know.
7 Q. Of course, it's to the best of
8 your knowledge, sir, I am not expecting you to
9 be on omniscient.
10 How about game applications?
11 A. I have no knowledge of what
12 IViewIt's doing.
13 Q. How about what they have done in
14 the past?
15 A. I have no knowledge of what they
16 have done in the past at this point in time.
17 Q. Is it that you have no knowledge
18 or you can't recall?
19 A. I don't know if I knew in the past
20 or didn't know in the past, I don't know now.
21 Q. So, in other words, sir, you have
22 no knowledge as to any technology that IViewIt
23 uses; is that correct?
24 A. At this point in time, that is
25 correct.

□

35

1 Rubenstein
2 Q. Did you have such knowledge in the
3 past?
4 A. I don't know whether I did or did
5 not, I don't know now.
6 Q. So, then, sir, you wouldn't have

7 any ability to know whether or not any of your
8 clients are using IViewIt technology; is that
9 correct?

10 A. I would have no idea.

11 Q. So it is possible, then, they
12 might be infringing on IViewIt's technologies?

13 MR. PRUSASKI: Object to the form.

14 A. What do you mean by "infringing"?

15 Q. Well, making use of IViewIt
16 technologies without the benefit of royalties
17 or some other kind of licensing.

18 A. I have no knowledge that IViewIt
19 has any proprietary rights in anything. And I
20 have no knowledge about what IViewIt's
21 technology is. So I have no knowledge about
22 who could be doing what.

23 Q. If IViewIt had technologies
24 concerning scaled video, let's say, and there
25 was some legally-protected interest in that

□

36

1 Rubenstein
2 technology, as a patent lawyer, would you
3 opine that the use of that by any other third
4 party would require either a licensing or
5 payment of a royalty?

6 A. I --

7 MR. PRUSASKI: Object to the form.

8 Q. You may answer the question.

9 A. I will answer the question. I

10 would not have an answer to that question in
11 the abstract, you are asking for complex legal
12 analysis of a situation where you are only
13 giving a vague hypothetical fact pattern, so
14 it's not possible to give an answer to that
15 question.

16 Q. Well, let me restate it, then,
17 maybe I can make it clearer for you, sir.

18 Let's say that IViewIt has
19 technology for camera zoom applications and
20 that technology is patented, and a client of
21 yours is making use of that technology without
22 the benefit of paying either a royalty or a
23 licensing agreement. Would there be legal
24 liability?

25 MR. PRUSASKI: Object to the

□

37

1 Rubenstein

2 form.

3 A. Why don't you explain more clearly
4 what you are trying to say.

5 Q. I thought I was trying to be
6 clear. Okay, let me try again.

7 Let's say specifically, and I
8 don't know if this particular entity is a
9 client of yours or not, but Sony used camera
10 zoom applications which were subject to a
11 patent or a patent pending by IViewIt.com, and
12 Sony made use of these technologies without

13 either a licensing agreement or without paying
14 a royalty. Would Sony be liable for damages
15 for use of this patented technology to
16 IViewIt?

17 A. Well, Sony's a client of the firm,
18 so I am not going to discuss what kind of
19 advice I might or might not give to Sony in
20 particular circumstances, you are asking for
21 privileged information.

22 Q. Okay. Then, instead of Sony we
23 will make it company X.

24 A. Like I say, you are asking for a
25 legal conclusion of mine, how I might advise a

□

38

1 Rubenstein
2 client in a particular fact pattern without
3 knowing the details. In order to answer that
4 question, I would have to study the patent in
5 question, the file history of the patent
6 before The Patent Office, the prior art of
7 record. I might have to look for other prior
8 art. I would also have to study what the
9 particular client is doing. I might have to
10 study what other proprietary rights the
11 company in question who owns those rights
12 might have before I would even conceive and
13 think about answering a question like that.
14 Q. We are doing this -- obviously,
15 you have the right to object if it's Sony.

16 what I am saying assuming, arguendo, this is a
17 valid and binding patent intellectual
18 property, that it is only enforceable under
19 the patent that's in place, and that there is
20 a clear case of infringement.

21 A. I answered the question to the
22 best of my ability already. It's on the
23 record.

24 If you want, we can ask the
25 reporter to read it back.

□

39

1 Rubenstein

2 Q. Your statement to me in response,
3 sir, was that you needed more specifics and
4 that you were unclear, and that you would have
5 to --

6 A. No, I told you that in order for
7 me -- I am going to repeat this once, just so
8 we are understanding it -- I told you in order
9 to advise a client in a particular situation,
10 I would have to study the patents in question,
11 the file histories of the patents before the
12 U.S. Patent Office, I would have to study the
13 prior art of record, I might study other prior
14 art, I would have to study the claims of the
15 patent, I would have to try to understand
16 their scope, I would have to try to understand
17 the technology that someone was trying to
18 apply the patents to, I would try to

19 understand whether there were other
20 proprietary rights besides patents in
21 question, and before I could answer the
22 question. I can't answer your question in the
23 abstract, it doesn't have a simple
24 straightforward "Yes" or "No" answer.

25 Q. well, assuming that all your

□

40

1 Rubenstein
2 review of the prior art and your review of the
3 application of the Patent Office and your
4 review of all those other documents that you
5 just mentioned indicated that it was a valid
6 and duly-enforceable patented right with
7 regard to a technology that was clearly
8 infringing on that patent right, would your
9 answer remain the same?

10 A. I answered the question to the
11 best of my ability.

12 Q. How long have you been a patent
13 lawyer, sir?

14 A. You know how long, at least --

15 Q. Go back --

16 A. -- more than 20 years.

17 Q. And how many patent cases have you
18 litigated?

19 A. I have litigated a number of them.

20 Q. How many is "a number of them"?

21 A. Quite a few.

22 Q. More than 50?
23 A. Probably not.
24 Q. More than 20?
25 A. Maybe.

□

41

1 Rubenstein

2 Q. Have any of those patent cases
3 dealt with an infringement claim?

4 A. They generally deal with
5 infringement claims.

6 Q. Could you tell me about the cases
7 that you have been involved with? Just naming
8 the cases.

9 MR. PRUSASKI: Objection.

10 Don't answer the question, it's
11 privileged.

12 (DIRECTION NOT TO ANSWER.)

13 MR. SELZ: The name of the cases
14 are privileged?

15 MR. PRUSASKI: Yes. And it's
16 harassment. He is a 20-year patent
17 lawyer at one of the largest law firms.
18 Why don't we need to go over this?

19 MR. SELZ: It seems to me he is
20 being very evasive about a lot of these
21 things.

22 MR. PRUSASKI: I don't think so.
23 You are asking a really simple
24 question that doesn't have a simple

25 answer.

□

42

1 Rubenstein

2 A. Yes, you are asking a question
3 that doesn't have a simple "Yes" or "No"
4 answer.

5 MR. PRUSASKI: And it is a
6 hypothetical, and he is not an expert.

7 Q. Have you ever met with Mr. Chris
8 wheeler?

9 A. I don't think I ever met him, no.

10 Q. Did you ever speak with him?

11 A. Possibly, yes.

12 Q. Do you have any specific
13 recollection as to when you spoke with him?

14 A. No.

15 Q. Have you ever billed any services
16 to IViewIt or any of the IViewIt entities?

17 A. As far as I know, I have not.

18 Q. Have you been included on a
19 billing statement for IViewIt --

20 A. As far as --

21 Q. -- on Proskauer Rose.

22 A. As far as I know, I have not.

23 Q. Did Mr. wheeler ever consult with
24 you, to the best of your recollection, with
25 regard to any issues concerning IViewIt?

□

43

Ken Rubenstein Deposition

1 Rubenstein

2 A. He might have, but I would not
3 recall the details at this time.

4 Q. would you have taken any
5 contemporaneous notes of those conversations?

6 A. Probably not.

7 Q. would you keep any other records
8 of those conversations?

9 A. I am not a big note taker of phone
10 conversations, so the answer would be no.

11 Q. would those conversations have
12 been reflected in any billing records that you
13 might keep?

14 A. Like I say, to my knowledge, I
15 never billed any services to IViewIt.

16 Q. well, I don't think that was my
17 question.

18 My question was, sir, if you did
19 have a conversation with Christopher wheeler
20 with regard to IViewIt, would it have been
21 reflected on your billing records?

22 A. Probably not, because it would
23 have been a minor short conversation.

24 Q. Did you ever come down to Florida
25 to meet with anyone from IViewIt?

□

44

1 Rubenstein

2 A. No.

Ken Rubenstein Deposition

3 Q. Did you ever make any
4 representation to any party that you can
5 recall with regard to IViewIt or its
6 technologies?

7 A. Not that I recall.

8 MR. PRUSASKI: Object to the form.

9 Q. Let me rephrase that. Have you
10 ever spoken to any third party with regard to
11 IViewIt's technologies?

12 A. Not that I recall at this time.

13 Q. Did you ever meet with anyone
14 named Stephen Filipek?

15 A. I don't know who he is.

16 Q. Were you ever included in any
17 business plan of IViewIt as a consultant or
18 any other representation as being involved
19 with the company?

20 A. Not that I know of at this time.

21 Q. If you were included on that
22 business plan as a consultant or advisor to
23 IViewIt, would you have consented to that or
24 would you have had to have consented to that?

25 A. I don't know whether I would have

□

45

1 Rubenstein
2 had to consent to it or not, and I don't know
3 if I would have consented or not.

4 Q. Have you ever seen a business plan
5 for IViewIt?

Ken Rubenstein Deposition

6 A. I don't know, I might have. I
7 might not have, I don't know.

8 Q. How about, did you ever speak to
9 anyone at Brian Utley?

10 A. I did have one or two phone
11 conversations with him.

12 Q. With regard to IViewIt?

13 A. Yes.

14 Q. And what were the contents of
15 those conversations?

16 A. I --

17 MR. PRUSASKI: Asked and answered.

18 MR. SELZ: I'm sorry.

19 A. And I will just answer it again,
20 for convenience, I don't know the details at
21 this point in time.

22 Q. How about Gerald Stanley?

23 A. I don't know who he is.

24 Q. Wayne Smith?

25 A. I don't think I ever had a

□

46

1 Rubenstein
2 conversation with Wayne Smith about IViewIt.
3 And Wayne Smith is a Warner Bros. in-house
4 attorney and, therefore, any conversation I
5 did have with him would be privileged.

6 Q. How about David Colter?

7 A. I am not sure who he is. I am
8 just not sure.

Ken Rubenstein Deposition

9 You might refresh my recollection
10 and tell me who he is. I am not sure who he
11 is.

12 Q. If you are not sure who he is, I
13 will not go any further.

14 How about a Hassan Miah?

15 A. I don't know who he is.

16 Q. How about Doug Che, with Sony?

17 A. I don't know who he is.

18 Q. Jerry Pierce, from Paramount
19 Viacom?

20 A. I don't know who he is.

21 Q. How about Aden Foley?

22 A. Don't know who he is.

23 Q. Chris Cook?

24 A. I don't know who Chris Cook is.

25 Q. It's Chris Cookson.

□

47

1 Rubenstein

2 A. Any conversation I have had with
3 Chris Cookson would be privileged.

4 Q. Okay. well, you know who Chris
5 Cookson is?

6 A. Yes, I do.

7 Q. Have you ever discussed IViewIt
8 Technologies with him?

9 MR. PRUSASKI: Don't answer the
10 question.

11 I am instructing him not to
 Page 42

Ken Rubenstein Deposition

12 answer.

13 (DIRECTION NOT TO ANSWER.)

14 Q. Did you ever become aware of any
15 problems with Raymond Joao's work as with
16 regard to patents for IViewIt?

17 A. Not that I recall at this time.

18 Q. Does Proskauer Rose maintain
19 patent counsel, other than yourself?

20 A. There are a number of patent
21 people in the law firm.

22 Q. Was there any particular reason
23 why IViewIt's patent applications were not
24 handled by Proskauer Rose?

25 A. Well, like I said, generally, I

□

48

1 Rubenstein

2 don't do patent prosecution work, as a general
3 matter.

4 Q. Did you see anything wrong or
5 faulty with Mr. Joao's work?

6 A. Like I say, I have no knowledge of
7 his work at this time, and don't recall ever
8 seeing anything faulty with it.

9 Q. Was there ever a time when
10 Mr. Joao was no longer employed by Meltzer
11 Lippe, to the best of your knowledge?

12 A. I think he did leave after a
13 certain period of time.

14 Q. And where did he go to work?

Ken Rubenstein Deposition

15 A. I have no idea.
16 Q. Do you have any knowledge as to
17 why Mr. Joao left or --
18 A. No.
19 Q. If you would just let me finish my
20 question, I would appreciate it.
21 MR. PRUSASKI: What was the
22 question?
23 MR. SELZ: I was going to finish
24 the question.
25 Q. Did you have any knowledge as to

□

49

1 Rubenstein
2 why Mr. Joao left or whether or not he was
3 terminated?
4 A. No.
5 Q. Okay. So you have no knowledge,
6 sir, then, of any of the patent applications
7 for IViewIt.com?
8 A. Not at this time, no.
9 Q. How about with regard to any of
10 the trademark or copyright applications?
11 A. No, none whatsoever.
12 Q. Have you ever heard of a company
13 called Zeosync, Z-E-O-S-Y-N-C?
14 A. I am not sure at this time.
15 Q. You are not sure whether or not
16 you have ever heard of it?
17 A. Yeah. Yeah, I don't think I know

Ken Rubenstein Deposition

18 at this time. I am not sure. What do they
19 do?

20 Q. Well, if you don't know what they
21 do and you don't know who they are, then
22 that's your answer.

23 A. All right, that's fine.

24 Q. Who recommended that IViewIt go to
25 Meltzer Lippe for their patent work?

□

50

1 Rubenstein

2 A. I probably suggested it.

3 Q. And was that suggestion
4 communicated in writing?

5 A. Probably not.

6 Q. And, if you can recall, who did
7 you communicate with at IViewIt concerning
8 your recommendation?

9 A. I don't recall.

10 Q. Did you ever meet with Eliot
11 Bernstein?

12 I think you might have said that
13 you never met with him before.

14 A. I don't think I ever met with him.

15 Q. Okay, and you said you don't know
16 who Jude Rosario is; correct?

17 A. Correct.

18 Q. And you don't know who Zackirul
19 Shirajee is; correct?

20 A. Correct.

Ken Rubenstein Deposition

21 Q. How about Jeffrey Friedstein?
22 A. I don't know who he is.
23 Q. Are you aware of whether or not
24 Proskauer Rose accepted any stock from
25 IViewIt?

□

51

1 Rubenstein
2 A. I would have no knowledge of that.
3 Q. Were you ever asked to evaluate
4 for Proskauer Rose the inventions that IViewIt
5 had?
6 A. Not that I recall, no.
7 Q. Did you ever see a video that led
8 you to believe that a company called Visual
9 Data was infringing upon IViewIt?
10 A. I never heard of Visual Data.
11 Q. Are you aware of any of the
12 billings that Proskauer Rose presented to
13 IViewIt for services?
14 A. To my knowledge, I have never seen
15 any such bill.
16 Q. Did you have any discussions with
17 any other partner or associate at Proskauer
18 Rose concerning the billings to IViewIt?
19 A. Not that I could recall.
20 Q. Okay. When I refer to "IViewIt",
21 I mean --
22 A. You mean all of those entities.
23 Q. Correct.

Ken Rubenstein Deposition

24 A. And the answer is, not that I
25 could recall.

□

52

1 Rubenstein

2 Q. Did Mr. Wheeler talk with you at
3 all about any infringement problems or patent
4 rights at IViewIt?

5 A. Not that I recall.

6 Q. And you earlier testified you have
7 never heard of a company called Visual Data;
8 is that correct?

9 A. Not that I can recall at this
10 time.

11 Q. Do you know an individual named
12 Gerald Lewin?

13 A. Gerald Lewin?

14 Q. Yes.

15 A. You mean the former CEO of Time
16 Warner?

17 Q. Yes.

18 A. Well, I know the name, but I don't
19 know him personally.

20 Q. How about Brian Utley?

21 A. Well, I told you already I had a
22 few telephone conversations with him.

23 Q. Other than those telephone
24 conversations, do you know anything of
25 Mr. Utley?

1 Rubenstein

2 A. No.

3 Q. How about Gerald Stanley, of
4 Real 3 D?

5 A. I never heard of him and never
6 heard of Real 3 D.

7 Q. You said that earlier.

8 How about Boca Research?

9 A. Never heard of Boca Research.

10 Q. How about Wayne Huizenga Jr. or
11 Sr.?

12 A. Well, I know the name, I don't
13 know them personally.

14 Q. How about Chris Brandon?

15 A. Never heard of him.

16 Q. Robert Henniger?

17 A. Never heard of him.

18 Q. Sportsline?

19 A. Sportsline, S-P-O-R-T-L-I-N-E?

20 Q. Correct.

21 A. I never heard of it.

22 Q. Hollywood.com, I think you
23 testified to earlier.

24 A. You asked me about that, and I
25 answered it already.

Ken Rubenstein Deposition
Rubenstein

1

2 Q. Correct.

3 How about Big E?

4 A. I never heard of it.

5 Q. Sensormatic?

6 A. S-E-N-S-O-R-M-A-T-I-C?

7 Q. Right.

8 A. I never heard of it.

9 Q. How about Sensormatics? I'm
10 sorry.

11 A. I don't think I heard of it,
12 either way, to my knowledge right now.

13 Q. How about CrossBow Ventures?

14 A. Well, I only know about it because
15 it was mentioned in some conversation to me
16 prior to this deposition, but I don't have any
17 knowledge of them, never met with them, never
18 had any dealing with them.

19 Q. And what conversation was this,
20 prior --

21 A. In preparation for this
22 deposition.

23 Q. Okay. Do you have any idea who
24 they are?

25 A. I know they are a venture

□

55

1 Rubenstein

2 capitalist, something like that.

3 Q. Are they a client of Proskauer

Ken Rubenstein Deposition

4 Rose?

5 A. I don't know.

6 Q. When Proskauer Rose would
7 represent a new client, would a conflict check
8 be run?

9 A. I think that's the normal
10 procedure of this and most other law firms.

11 Q. When you were contacted or spoke
12 to Mr. Wheeler with regard to IViewIt.com, did
13 you either request that Mr. Wheeler confirm
14 the conflict check had been run or did you
15 conduct one yourself?

16 A. I did not conduct one myself
17 because the client came in through Mr. Wheeler
18 and he -- in the normal procedure, it would be
19 up to him to do the conflict check.

20 Q. Okay, so you relied on the fact
21 that Mr. Wheeler had done one?

22 A. I relied on the fact that it would
23 be the normal procedure in this law firm for
24 him to have done it.

25 Q. But you can't tell me whether or

□

56

1 Rubenstein

2 not today, as you sit here, whether or not one
3 was done.

4 A. I would say it would be the normal
5 procedure in this law firm for it to be done.

6 Q. But do you have any personal

7 knowledge which would indicate to you directly
8 that a conflict check had been run with regard
9 to IViewIt?

10 A. Well, the fact is, in this law
11 firm they would not assign a client billing
12 number to the client without a conflict check
13 being done, and I understand the client
14 billing number was assigned, so that means a
15 conflict check was done --

16 Q. And --

17 A. -- or would normally have been
18 done.

19 Q. Normally, but what I am asking you
20 very specifically is, sir, you do not know for
21 a fact whether or not a conflict check was
22 run?

23 A. Not at this point in time, I do
24 not know.

25 Q. And if there was a conflict found,

□

57

1 Rubenstein
2 what would be the normal procedure?

3 A. It would go to the -- there is a
4 committee that -- in this law firm, that deals
5 with those issues.

6 Q. Does that committees ever obtain
7 waivers of conflicts from clients?

8 A. They might.

9 MR. PRUSASKI: Don't answer the

10 Ken Rubenstein Deposition
question, it's privileged.

11 (DIRECTION NOT TO ANSWER.)

12 Q. Do you maintain any files or any
13 documents concerning IViewIt?

14 MR. PRUSASKI: Him personally?

15 MR. SELZ: In his business records
16 or in his records for Proskauer Rose at
17 the offices in New York.

18 A. Not that I know of, no.

19 Q. Do you know of any patenting of
20 inventions for IViewIt?

21 A. Like I say, I was not involved as
22 their patent counsel, other people served as
23 their patent counsel.

24 Q. Are you aware of any of the
25 particulars of any of those patents?

□

58

1 Rubenstein

2 A. I was not --

3 MR. PRUSASKI: This --

4 A. I will repeat it again, I was not
5 involved as their patent counsel, other people
6 were. And, at this point in time, I have no
7 knowledge of their patent applications.

8 MR. PRUSASKI: Mr. Selz, you are
9 repeating yourself now.

10 MR. SELZ: I'm sorry, Chris.

11 MR. PRUSASKI: Eliot needs to type
12 some new questions.

Ken Rubenstein Deposition
13 A. Maybe he didn't get a good night's
14 sleep.

15 (Pause.)

16 MR. PRUSASKI: Do you have
17 anything else?

18 MR. SELZ: Yes, I do. Just give
19 me a minute. (Pause.)

20 Q. Sir, do you have any knowledge or
21 have you reviewed any of the billing
22 statements that Proskauer Rose provided to
23 IViewIt in this matter?

24 A. No.

25 MR. PRUSASKI: Objection, asked

□

59

1 Rubenstein

2 and answered.

3 Q. Are you aware of any of the
4 services provided by Proskauer Rose to IViewIt
5 in this matter?

6 A. I have no idea.

7 Q. (Pause.)

8 MR. PRUSASKI: Do you have
9 anything else?

10 MR. SELZ: Yes. Just give me a
11 couple of minutes, I am just thinking
12 through this stuff.

13 MR. PRUSASKI: Nothing personal,
14 Mr. Selz, but you are really repeating
15 yourself at this point.

Ken Rubenstein Deposition

16 MR. SELZ: I am trying not to.
17 MR. PRUSASKI: I mean, you asked
18 him twice if he has seen the bills
19 within like three minutes.
20 MR. SELZ: (Pause.)
21 Q. Are you aware of any individuals
22 involved in the MIT Multimedia Lab?
23 A. Personally, no, not at this point.
24 Q. When was the last time you spoke
25 to Brian Utley? You indicated you had a

□

60

1 Rubenstein
2 couple of conversations with him. When was
3 the last discussion held, that you can recall?
4 A. I am not sure.
5 Q. Was it more than a year ago?
6 A. Probably.
7 Q. Do you remember the contents of
8 that conversation at all?
9 A. No. And you asked me that
10 already.
11 Q. I know I did. I am trying to help
12 to refresh your recollection.
13 A. You asked me at least three times
14 that question, so now you are at the point of
15 wasting my time, so I would appreciate it, if
16 you want to ask me some questions, please ask
17 me questions you did not ask me already.
18 Q. Is there anyone else, other than

Ken Rubenstein Deposition

19 Brian Utley at IViewIt, that you ever had any
20 discussions with?

21 MR. PRUSASKI: You have asked
22 that, about five times.

23 A. You asked me that already.

24 MR. PRUSASKI: And he said no.

25 A. And I answered it already. You

□

61

1 Rubenstein
2 will see the transcript, and you will see the
3 answer.

4 Q. Okay, fine.

5 MR. PRUSASKI: Mr. Selz, is your
6 client sending you questions over the
7 computer?

8 MR. SELZ: No, no, I have got my
9 notes that I have made to ask questions,
10 and I am just trying to correspond
11 Mr. Rubenstein's answers with my
12 questions.

13 MR. PRUSASKI: Are you
14 communicating with him electronically?

15 MR. SELZ: No, I am not.

16 MR. PRUSASKI: Has he been on the
17 phone the whole time?

18 MR. SELZ: Yes.

19 MR. PRUSASKI: He is in
20 San Diego?

21 MR. SELZ: Yes.

22 Ken Rubenstein Deposition
MR. PRUSASKI: Let the record
23 reflect he is taking out time --
24 MR. SELZ: He is sitting in the
25 room next to his wife, waiting for his

□

62

1 Rubenstein
2 wife to go into labor and go into the
3 hospital and --
4 MR. PRUSASKI: And he could have
5 sat in the same room a week-and-a-half
6 ago to have his deposition taken. If he
7 is able to appear at depositions on the
8 telephone, he could have had a
9 deposition taken at his house.
10 MR. SELZ: He can cut out any
11 minute he wants with me, but he can't do
12 it with you, if you have a deposition
13 scheduled.
14 MR. PRUSASKI: We could have
15 accommodated him just fine.
16 MR. SELZ: I am going to put you
17 on hold for a minute.
18 (Pause in proceedings.)
19 MR. SELZ: Okay, Chris, I have
20 been talking to Eliot, he is going to
21 check on his wife, who is in the next
22 room. Let's take a ten-minute break and
23 come right back.
24 MR. PRUSASKI: Okay. I expect you

25 Ken Rubenstein Deposition
both to have some new questions or I

□

63

1 Rubenstein
2 need to go, because we are both very
3 busy.

4 MR. SELZ: I understand, so is
5 everyone.

6 MR. PRUSASKI: So, it's 12:02, we
7 will see you promptly at 12:12 with new
8 questions.

9 Do you want to call us back at
10 this number?

11 MR. SELZ: I will call you back at
12 this number.

13 (Recess taken: 12:04 p.m.-
14 12:16 p.m.)

15 Q. Did you ever receive a letter from
16 Stephen Lamont with regard to IViewIt
17 technology?

18 A. A letter from Stephen Lamont?

19 Q. Yes.

20 A. Not that I know of at this time.

21 Q. Okay.

22 MR. SELZ: Chris, can you give me
23 the fax number there? I will fax you a
24 copy of this letter, for the witness --
25 for the deponent to review.

□

64

Ken Rubenstein Deposition

1 Rubenstein

2 A. I don't know how we are going to
3 orchestrate that.

4 Q. You have got a fax up there?

5 A. We do. We've just got to --

6 MR. PRUSASKI: It's not something
7 that can be delivered immediately?

8 THE WITNESS: Right.

9 MR. SELZ: What I will do is, I
10 will continue with other questions until
11 it's delivered.

12 MR. PRUSASKI: The fax number is
13 969-2900. And you will need to have it
14 delivered to Mr. Rubenstein's office
15 immediately.

16 A. It will probably come out in my
17 E-mail, so we will have to have someone print
18 it out.

19 MR. SELZ: Let me just go and take
20 care of that.

21 Hold on for a moment.

22 (Pause in proceedings: 12:17 p.m.-
23 12:25 p.m.)

24 MR. SELZ: Okay, we are back on.

25 A. Okay.

□

65

1 Rubenstein

2 Q. Okay.

Ken Rubenstein Deposition

3 Now, Mr. Rubenstein, have you
4 looked at any of the billing statements that
5 Proskauer Rose produced to IViewIt in this
6 matter at all?

7 A. Okay, so, number one, you asked me
8 that, I answered it already.

9 Number two, I would like to note,
10 for the record, that we took a break at 12:02,
11 you were supposed to come back at 12:12, you
12 were late, and the first thing you did, upon
13 coming back, was take another break of about
14 nine or ten minutes so you could send me a
15 fax, which could have been sent here in
16 advance. And you are wasting my time by
17 asking me questions that I have already
18 answered.

19 Q. what did you do to prepare for
20 this deposition?

21 A. I met with my attorney.

22 Q. Did you review any documents?

23 A. I reviewed answers to
24 interrogatories briefly that were prepared by
25 Mr. Bernstein.

□

66

1 Rubenstein

2 Q. Did you review any other
3 documents?

4 A. I reviewed a brief segment of
5 Mr. Utley's deposition -- actually, I did not

Ken Rubenstein Deposition

6 review anything from Mr. Utley's deposition,
7 that's a mistake. I may have discussed it
8 with my attorney, but you are getting into
9 privileged information, so I cannot answer it
10 any further.

11 Q. So those are the only things that
12 you reviewed?

13 A. The only thing I looked at was
14 Mr. Bernstein's answers to interrogatories,
15 and I did meet with my attorney.

16 Q. Are you aware, sir, that your name
17 is referenced in billing statements from
18 Proskauer Rose to IViewIt more than a dozen
19 times?

20 A. No, I am not.

21 MR. PRUSASKI: Object to the form.

22 Q. Can you think of any reason, sir,
23 why your name would be mentioned more than a
24 dozen times in billing statements from
25 Proskauer Rose to IViewIt?

□

67

1 Rubenstein

2 A. I had a few conversations with
3 different people about the company over time,
4 as I have testified.

5 Q. And you testified that the
6 conversations took place between you and Chris
7 wheeler and you and Brian Utley.

8 A. Right.

Ken Rubenstein Deposition

9 Q. Correct?
10 A. Possibly -- I don't know if there
11 was anyone else.
12 Q. Do you have any recollection now
13 as to any other conversations?
14 A. No.
15 Q. Now, with regard to E-mails, were
16 you aware of any E-mails that you received
17 from anyone concerning IViewIt?
18 A. I don't know at this point in
19 time.
20 Q. Do you have records of E-mails
21 that you received?
22 A. I would not know at this point in
23 time.
24 Q. Are they normally kept as part of
25 your files?

□

68

1 Rubenstein
2 A. I don't know at this point in
3 time.
4 Q. I had asked you previously, sir,
5 whether or not you had any information on
6 Mr. David Colter.
7 Do you recall that?
8 A. Yes, and I said I wasn't sure who
9 he was, and I suggested you might want to
10 refresh my recollection, and you declined to
11 do so.

Ken Rubenstein Deposition

12 Q. Okay. would it refresh your
13 recollection, sir, if I tell you that
14 Mr. Colter was with Warner Bros.?

15 A. You know, I may have heard the
16 name, but I don't think I ever had any
17 dealings with him, although I am not sure.

18 Q. But you do have dealings with
19 Warner Bros.; is that correct?

20 A. Like I said, Warner Bros. is a
21 client.

22 Q. Right. would there be any reason
23 why your name would be mentioned in E-mails,
24 that you can think of, from Warner Bros. to
25 someone at AOL?

□

69

1 Rubenstein

2 A. I don't know.

3 I mean, I do work -- they are part
4 of the same company, they are clients of the
5 firm, and so, I can't really discuss it
6 because of privilege.

7 Q. Sir, you had indicated earlier you
8 had no idea with regard to any of the
9 intellectual properties or patents for
10 IViewIt; is that correct?

11 A. Not at this point in time.

12 Q. Did you ever issue any opinion to
13 anyone as to the validity of those patents?

14 A. Not that I know of.

Ken Rubenstein Deposition

15 Q. Did you ever provide any
16 information at all with regard to the validity
17 of any of these patents?

18 A. Not that I know of.

19 Q. So it's possible that you have in
20 the past but you don't recall?

21 A. I don't recall having involvement
22 with these patents. I was not the patent
23 counsel.

24 Q. Now, sir, we have faxed you a copy
25 of a letter. I don't know if you have

□

70

1 Rubenstein
2 received it.

3 A. We don't have it yet.

4 Q. Okay, could you find out if that's
5 available?

6 A. All right. We will put you on
7 hold.

8 Q. Thank you.

9 (Pause in proceedings.)

10 Q. Okay, are you with me?

11 A. Yes.

12 Q. Do you have the fax?

13 A. No, I do not. Like I say, you
14 should have sent it up here yesterday or in
15 advance.

16 Q. That's fine, that's fine. I was
17 expecting that maybe you would have a better

Ken Rubenstein Deposition

18 recollection of some of these events, and
19 maybe that was my incorrect presumption,
20 considering that I guess the communication
21 from Stephen Lamont occurred relatively
22 recently --

23 A. Well, when did it occur?

24 Q. Well, that's what I was going to
25 ask you, first of all, if you can recall.

□

71

1 Rubenstein

2 A. Well, you asked me about that, and
3 I told you I may have spoken to him once, but
4 I don't recall the details right now.

5 Q. Now, with regard to what we talked
6 about earlier was the conflict of interest and
7 whether or not Proskauer Rose's position in
8 representing IViewIt constituted a conflict
9 with other clients, I think you mentioned that
10 you expected Mr. Wheeler to do the conflict
11 check; is that correct?

12 A. Yes.

13 Q. Are you aware of any conflict of
14 interest between IViewIt and any of your own
15 clients?

16 A. No.

17 MR. PRUSASKI: What's the
18 relevancy of that, Mr. Selz?

19 MR. SELZ: I think it goes to
20 whether or not IViewIt should have been

Ken Rubenstein Deposition

21 represented by Proskauer Rose in the
22 first place.

23 MR. PRUSASKI: Oh, is that a new
24 theory that you haven't pled?

25 MR. SELZ: Is that an objection?

□

72

1 Rubenstein

2 MR. PRUSASKI: Yes, it's objection
3 to relevance.

4 MR. SELZ: Okay, so noted for the
5 record.

6 Q. Mr. Rubenstein, you had indicated
7 that you are not aware of any conflicts
8 between IViewIt and any of your other clients;
9 is that correct?

10 A. Not at this point in time, no.

11 Q. Were you aware of any conflicts in
12 the past?

13 A. Not that I know of.

14 Q. Would there be any records kept of
15 any conflict check that was run by Mr. Wheeler
16 or any other --

17 A. I don't know.

18 Q. Would you let me finish my
19 question, please.

20 -- Mr. Wheeler or any other
21 partner or associate of your firm.

22 A. I don't know what records there
23 might be.

Ken Rubenstein Deposition

24 Q. You indicated there was a conflict
25 committee. Does that conflict committee meet

□

73

1 Rubenstein
2 in New York or do they meet in Florida or is
3 there any particular location for their
4 meetings?

5 MR. PRUSASKI: Objection,
6 relevance.

7 You can answer this question, but
8 it's not going to get much further.

9 A. I assume they meet in New York.

10 Q. Is there any particular reason for
11 that assumption?

12 A. Most of the law firm is in
13 New York.

14 Q. Sir, I am a little confused about
15 some of your earlier testimony. I had asked
16 you whether or not you had spoken with any of
17 your clients concerning IViewIt and its
18 technology, and your response was to claim
19 privilege. Is that still the case, you are
20 claiming privilege with regard to any of those
21 communications?

22 MR. PRUSASKI: Yes.

23 A. Yes.

24 Q. Okay. I am going to just say at
25 this point that you testified that there were

1 Rubenstein
2 only two occasions that you had spoken with
3 third parties Mr. Utley and Mr. Wheeler that
4 you can recall with regard to IViewIt; is that
5 correct?

6 MR. PRUSASKI: I don't recall that
7 being his testimony.

8 A. That's not my testimony.

9 Q. What was your testimony?

10 A. We will have to have it read
11 back. I don't remember exactly what I said --

12 Q. Okay.

13 A. -- in response to which particular
14 question right now.

15 Q. Well, let me pose a new question,
16 sir, and I think I have asked you this before,
17 and I am going to pose it again because I am
18 unclear now.

19 You have communicated with third
20 parties with regard to IViewIt; is that
21 correct?

22 A. Well, what do you mean by "third
23 parties"?

24 Q. People or entities other than
25 IViewIt.

Ken Rubenstein Deposition
Rubenstein

1

2 A. Uh -- I might have, I might not
3 have, I am not sure right now.

4 Q. And those third parties you are
5 saying are clients of yours, is that why you
6 are asserting a privilege?

7 A. Well, it depends who you mean by a
8 "third party". You know, "third party" is a
9 vague term.

10 why don't you name some particular
11 third parties and I will answer the question,
12 if I have haven't answered it already.

13 Q. I think you said that you were
14 asserting a privilege with regard to Warner
15 Bros., I think you said --

16 A. Well, Warner Bros. is a client
17 here.

18 Q. Right. And Sony.

19 A. Sony is a client here.

20 Q. Right. So you refuse to answer
21 whether or not you had communicated to those
22 parties with regard to IViewIt; is that
23 correct?

24 A. Correct, or anything else I might
25 have communicated to them.

□

76

1 Rubenstein

2 Q. Well, I am not asking you about
3 anything else, because, really, frankly, sir,

4 that's not only not relevant but, clearly,
5 that would be privileged, but I am asking you
6 with regard to simply IViewIt --

7 A. Well, you know, that's our
8 position, our position is that any
9 conversation with those entities is
10 privileged.

11 Q. Okay, and if there was a
12 discussion -- are you saying there was no
13 discussion or are you saying there was a
14 discussion that was privileged?

15 A. I am not saying there was a
16 discussion, I am not saying there was not a
17 discussion, I am saying it's privileged.

18 Q. So you can't simply answer no,
19 there was no discussion --

20 A. I am not saying there was, I am
21 not saying there was not, I am saying it's
22 privileged.

23 MR. SELZ: I am going to certify
24 that question, we will take it up with
25 Judge Labarga and see what his

□

77

1 Rubenstein
2 determination is about that.

3 (RULING SOUGHT.)

4 Q. Now, with regard to any other
5 issues concerning IViewIt.com or any IViewIt
6 entities, have you had any communications

7 since the filing of this lawsuit with anyone
8 concerning IViewIt?

9 A. Well, I don't know when the
10 lawsuit was filed.

11 Q. Since 2001, have you had any
12 communications with anyone concerning IViewIt
13 Technologies or any of the IViewIt entities?

14 A. Not that I recall at this time.

15 Q. Have you spoken to Ray Joao with
16 regard to it?

17 MR. PRUSASKI: Asked and
18 answered.

19 A. You asked me about Ray Joao
20 already.

21 Q. Since 2001.

22 A. Not that I know of at this time.

23 Q. Sir, have you ever been involved
24 in setting up corporations for clients?

25 A. No.

□

78

1 Rubenstein

2 Q. Have you ever made any
3 representations to any company or any entity
4 with regard to the advisability of setting up
5 corporations for them?

6 A. Not that I know of.

7 Q. Who would you refer that to at
8 Proskauer Rose if there was --

9 A. I am not sure, it would depend on

10 the particular situation.
11 Q. Do you have any idea what
12 Mr. Wheeler's specialization is?
13 A. No.
14 Q. Have you ever spoken with him with
15 regard to the legal services he was providing
16 to IViewIt?
17 A. You asked me that --
18 MR. PRUSASKI: Asked and
19 answered.
20 A. -- already and I answered it.
21 Q. And what was your answer again,
22 sir, "No"?
23 A. I don't remember the exact
24 question you asked, so I don't remember the
25 exact wording of my answer, what the question

□

79

1 Rubenstein
2 was -- but the question was asked and
3 answered.
4 Q. Do you have that fax yet?
5 A. No. We will call my secretary
6 again.
7 I will put you on hold.
8 Q. Okay.
9 (Pause in proceedings.)
10 A. Okay, the fax is coming, so we are
11 just going to put you on hold for a minute.
12 Q. Thank you?

13 Ken Rubenstein Deposition
(Pause in proceedings: 12:35 p.m.-
14 12:41 p.m.)
15 A. All right. We have your letter.
16 Q. Do you ever recall seeing this
17 letter?
18 MR. SELZ: Let's get it marked,
19 first of all, by the court reporter as
20 Defendants' 1.
21 A. The letter is dated today, and I
22 never saw it before.
23 Q. Have you ever seen the contents of
24 this letter?
25 A. No. I haven't read the letter

□

80

1 Rubenstein
2 yet.
3 Q. Okay.
4 A. I note that the letter is two-plus
5 pages long, I haven't read it. The letter is
6 dated today, November 20, 2002, and it's
7 unsigned, so this is a letter you guys,
8 IViewIt, created today.
9 Q. Well, I think that's a presumption
10 that you are putting into the record, sir.
11 A. Well, the letter I have in front
12 of me is dated today.
13 Q. Let me go ahead.
14 First of all, let's get it marked
15 as Number 1, Defendants' 1.

Ken Rubenstein Deposition

16 MR. PRUSASKI: Objection to the
17 predicate, he has never seen it before.
18 MR. SELZ: Let me ask him a
19 question about it first. I haven't even
20 examined him on it. Let me -- Chris,
21 this is my deposition of him, and I
22 appreciate the fact that he wants to get
23 this over, but that isn't an excuse for
24 him to jump the gun.
25 MR. PRUSASKI: I have a right to

□

81

1 Rubenstein
2 make objections as I see fit, and I am
3 not taking instructions out of practice
4 law from you.
5 MR. SELZ: That's fine. I am just
6 saying, let me get it marked first.
7 (Deposition Exhibit Defendants' 1,
8 letter dated, November 20, 2002, with
9 fax transmittal cover sheet, was marked
10 for identification, as of this date.)
11 Q. Mr. Rubenstein, do you have in
12 front of you what's been marked as Defendants'
13 Number 1? Is that correct?
14 A. Yes.
15 Q. Okay, could you please read it for
16 me?
17 MR. PRUSASKI: Out loud?
18 Q. No, to yourself.

19 A. well, I will scan it, but I want
20 to note it's a two-page letter, I have not had
21 an opportunity to study it. So if you ask me
22 questions about the letter, I am going to tell
23 you I have not had an opportunity to study it.
24 Q. Okay, then I will go through the
25 letter paragraph by paragraph with you to see

□

82

1 Rubenstein
2 if you recall any of it.

3 Do you ever recall receiving a
4 correspondence from Stephen Lamont?

5 A. Like I say, I haven't had a chance
6 to study your letter.

7 Q. I am not talking about this
8 particular --

9 A. I don't recall any correspondence
10 from Stephen Lamont at this point in time.

11 Q. Do you ever recall a request by
12 Wayne Smith of Warner Bros. as to IViewIt's
13 pending patents?

14 A. No. It might be that somebody at
15 IViewIt asked me to talk to Warner Bros. and I
16 declined. That might be the fact.

17 Q. Are you aware of any
18 confidentiality agreement executed by Warner
19 Bros. with regard to IViewIt?

20 A. No.

21 Q. Have you ever seen any such

22 agreement?

23 A. Not that I could recall.

24 Q. Again, sir, this letter refers to
25 you being on the advisory board of IViewIt

□

83

1 Rubenstein

2 between fall of 1999/spring of 2000.

3 A. I was never on any advisory board
4 of IViewIt.

5 Q. Did Stephen Lamont ever meet with
6 you in person?

7 A. I think I -- as I testified, I may
8 have had a conversation with him, I don't know
9 if it was in person or not.

10 Q. You previously testified that you
11 had never reviewed any of IViewIt's
12 technologies; is that correct?

13 A. I never testified to that. What I
14 told you is, I don't have any knowledge of it
15 right now.

16 Q. Okay.

17 A. I don't know whether I reviewed it
18 or not.

19 Q. So it's possible, then, sir, that
20 you did review it.

21 A. Like I said, I answered the
22 question. You asked me, I answered it. I
23 don't know whether I reviewed it or not. I
24 have no knowledge of it right now. I was not

Ken Rubenstein Deposition
25 their patent attorney, I was not involved with

□

84

1 Rubenstein

2 their patents.

3 Q. Okay, if you don't have a
4 recollection of reviewing it, but then it's
5 possible that you had; is that correct?

6 MR. PRUSASKI: Anything's
7 possible. I think we could stipulate to
8 that.

9 A. Right, I don't think it's possible
10 but -- and I don't think it happened.

11 Q. Do you have any clearer
12 recollection of it because of this letter?

13 A. No, I don't have a detailed
14 recollection or any recollection of it at this
15 point in time.

16 Q. And, again, I think you had
17 testified that you don't know anyone -- Greg
18 Thagard, you don't know Greg Thagard?

19 A. I do know Greg Thagard.

20 Q. Who is Greg Thagard?

21 A. He used to work at Warner Bros.

22 Q. Does Mr. Thagard, to the best of
23 your knowledge, have any information
24 concerning IViewIt?

25 A. I don't know at this point in

□

85

Ken Rubenstein Deposition

1 Rubenstein

2 time.

3 Q. What, to the best of your
4 recollection, was Greg Thagard's role with
5 regard to IViewIt?

6 A. I don't know what he might or
7 might not have done with respect to IViewIt.

8 Q. Who is Greg Thagard?

9 A. He is a person who worked at
10 Warner Bros.

11 Q. Well, what was his position --

12 A. He was in technical -- in the
13 technology side of the company.

14 Q. Do you have any idea where
15 Mr. Thagard is currently?

16 A. No. I believe he left the
17 company.

18 Q. How about Chris Cookson, did you
19 ever have any conversations with Chris Cookson
20 concerning IViewIt Technologies?

21 A. Like I say, Chris Cookson works
22 for Warner Bros., and any conversations I had
23 with Warner Bros. are privileged. So, I am
24 not saying I had a conversation, I am not
25 saying I did not have a conversation, I am

□

86

1 Rubenstein

2 saying you are asking for privileged material.

Ken Rubenstein Deposition

3 Q. And David Colter?

4 A. I am not sure I ever had any
5 dealings with him.

6 Q. And who is David Colter?

7 A. You asked and I answered that
8 question already.

9 Q. So you have never seen this
10 correspondence, you don't recall seeing this
11 correspondence from Mr. Lamont; is that
12 correct?

13 MR. PRUSASKI: It's dated today.

14 A. It's dated today.

15 MR. PRUSASKI: It's marked
16 "Draft". It's impossible for us to
17 have seen it before. And the return
18 address is an empty house in Los Angeles
19 County.

20 Q. Have you ever seen the contents of
21 this letter before?

22 A. I have never --

23 MR. PRUSASKI: He answered these
24 questions, no?

25 A. I have never seen the letter

□

87

1 Rubenstein

2 before.

3 Q. How about the E-mails that were
4 faxed over to you, as well? There is an
5 E-mail that's dated August 6, 2001. Have you

Ken Rubenstein Deposition

6 ever seen that E-mail before?

7 A. Is this an E-mail from David
8 Colter to Heidi Krauel?

9 Q. Correct.

10 MR. PRUSASKI: The one dated
11 August 1, 2001?

12 MR. SELZ: Correct.

13 A. Right, I see the E-mail.

14 Q. Okay.

15 MR. SELZ: Let's get it marked as
16 2.

17 (Deposition Exhibit Defendants' 2,
18 fax transmittal cover sheet and E-mails,
19 was marked for identification, as of
20 this date.)

21 Q. Sir, do you have any reason to
22 know why your name is mentioned in that
23 E-mail?

24 A. No, because I don't recall giving
25 any opinions about the patents.

□

88

1 Rubenstein

2 Q. And you never, to the best of your
3 recollection, had any discussions with
4 Mr. Thagard with regard to same, either?

5 A. Like I say, any discussion I might
6 have or might not have had with Mr. Thagard
7 would be privileged.

8 Q. I am going to put you on hold for
Page 79

Ken Rubenstein Deposition

9 just a minute.

10 (Pause.)

11 MR. SELZ: Okay, we are back on.

12 Okay, I have got nothing further
13 at this time. However, we are going to
14 have to go to Judge Labarga with regard
15 to your refusal to answer on some of
16 these issues with your claim of
17 privilege, so we may have to come back
18 and conclude with those questions at a
19 later date.

20 MR. PRUSASKI: Fine.

21 THE WITNESS: We will take it
22 under advisement.

23 We are not committing to come back
24 or not.

25 MR. SELZ: That's fine.

□

89

1

2 (Time noted: 12:48 p.m.)

3

4

5

KENNETH RUBENSTEIN

7

8 Subscribed and affirmed

9 before me this ____ day

10 of _____, 2002.

11 _____

Ken Rubenstein Deposition

12
13
14
15
16
17
18
19
20
21
22
23
24
25

□

90

1
2
3
4
5
6
7
8
9
10
11
12
13
14

C E R T I F I C A T E

STATE OF NEW YORK)
 : ss.
COUNTY OF NEW YORK)

I, WENDY D. BOSKIND, a Registered
Professional Reporter and Notary Public
within and for the State of New York,
do hereby certify:

That KENNETH RUBENSTEIN, the
witness whose deposition is hereinbefore
set forth, affirmed before me, and
that such deposition is a true and
accurate record of the testimony given

Ken Rubenstein Deposition

15 by the witness.

16 I further certify that I am not
17 related to any of the parties to this
18 action by blood or marriage, and that
19 I am in no way interested in the
20 outcome of this matter.

21 IN WITNESS WHEREOF, I have
22 hereunto set my hand this 26th day
23 of November, 2002.

24
25 _____
WENDY D. BOSKIND, RPR

□

1

2 November 20, 2002

3 I N D E X

4 WITNESS	EXAMINATION BY	PAGE
5 Kenneth Rubenstein	Mr. Selz	4

6

7 ----- EXHIBITS-----

8 Defendants' 1, letter dated, November 20,		
9 2002, with fax transmittal cover sheet.....		81
10 Defendants' 2, fax transmittal cover		
11 sheet and E-mails.....		87

12

13

14 (DIRECTION NOT TO ANSWER.).....		25
15 (DIRECTION NOT TO ANSWER.).....		28
16 (DIRECTION NOT TO ANSWER.).....		30
17 (DIRECTION NOT TO ANSWER.).....		41

Ken Rubenstein Deposition

18 (DIRECTION NOT TO ANSWER.)..... 47
19 (DIRECTION NOT TO ANSWER.)..... 57
20
21 (MOTION TO STRIKE.) 10
22
23 (RULING SOUGHT.)..... 77
24
25

□

1
2 STATE OF NEW YORK) Pg__of__Pgs
3 ss:
4 COUNTY OF NEW YORK)
5 I wish to make the following changes,
6 for the following reasons:
7 PAGE LINE
8 ____ ____ CHANGE: _____
9 REASON: _____
10 ____ ____ CHANGE: _____
11 REASON: _____
12 ____ ____ CHANGE: _____
13 REASON: _____
14 ____ ____ CHANGE: _____
15 REASON: _____
16 ____ ____ CHANGE: _____
17 REASON: _____
18 ____ ____ CHANGE: _____
19 REASON: _____
20 ____ ____ CHANGE: _____

Ken Rubenstein Deposition

21 REASON: _____
22 _____ CHANGE: _____
23 REASON: _____
24 _____ CHANGE: _____
25 REASON: _____

□



EXHIBIT B



IVIEWIT HOLDINGS, INC.

By Facsimile

February 26, 2003

Thomas J. Cahill
Chief Counsel
First Judicial Department Departmental Disciplinary Committee
61 Broadway, 2nd Floor
New York, New York 10006

Re: General Complaint against Raymond Anthony Joao on Behalf of Iviewit Holdings, Inc. (a Delaware Corporation) ("Company")

Dear Mr. Cahill:

By way of introduction, I am President (Acting) of the above referenced Company, and write to file a General Complaint against the following member of the New York State Bar Association:

Raymond Joao, Esquire
122 Bellevue Place
Yonkers, NY 10703
914-969-2992

Introduction

Raymond A. Joao, (hereinafter "Joao"), believed to be a resident of the State of New York, and who at various times relevant hereto was initially misrepresented to the Company as a partner of Proskauer Rose LLP (hereinafter "Proskauer") and was factually a partner of Meltzer Lippe Goldstein and Schlissel, and who provided legal services to the Company.

Moreover, beginning on or about September of 1998, the Company, through its agent and principal, Eliot I. Bernstein ("Bernstein"), began negotiations with Proskauer with regard to Proskauer providing legal services to the Company the purpose of which was to develop and market specific technologies developed by Bernstein and two others, which technologies allowed for the scaling, enlargement, panning and zooming of digital images and video without degradation to the quality of the digital image due to what is commonly referred to as "pixelation", the delivery of digital video using proprietary scaling techniques, a combination of the image pan and zoom techniques and video scaling techniques, and the remote control of video and image applications.



Furthermore, Bernstein engaged the services of Proskauer and in turn Joao, among others, through an engagement letter a true copy of which I attach herein as Exhibit "A", to obtain multiple patents and oversee US and foreign filings for such technologies including the provisional filings for the technologies as described above, and such other activities as were necessary to protect the intellectual property.

Additionally, upon information and belief, Joao upon viewing the technologies developed by Bernstein, and held by the Company, realized the significance of the technologies, its various applications to communication networks for distributing video data and images and for existing digital processes, including, but not limited to digital cameras, digital video disks (DVD), digital imaging technologies for medical purposes and digital video, and that Rubenstein designed and executed, sometimes for himself or others similarly situated, deceptions, improprieties, and, even in certain circumstances, outright malfeasances by the disingenuous insertion of his own interests or the interests of third parties, who were other clients of Proskauer and/or Meltzer Lippe Goldstein and Schlissel, between the Company, as his client and together with its disclosed techniques, and the ultimate end users of its future OEM and other licensees, to the detriment and damage of the Company. Many of the malfeasances against the Company have also involved fraud against the US Patent and Trademark Office.

Specifics of General Complaint

Where the Company employed Joao, Proskauer and Meltzer Lippe Goldstein & Schlissel for purposes of representing the Company to obtain multiple patents and oversee foreign filings for such technologies including the provisional filings for the technologies as described above, and that pursuant to such employment, Joao, Proskauer and Meltzer Lippe Goldstein & Schlissel owed a duty to ensure that the rights and interests of the Company were protected, Joao, Proskauer and Meltzer Lippe Goldstein & Schlissel neglected that reasonable duty of care in the performance of legal services in that they:

- a. Failed to take reasonable steps to ensure that the intellectual property of the Company was protected; and,
- b. Failed to and/or inadequately completed work regarding patents, copyrights and trademarks; and,
- c. Failed to list proper inventors of the technologies based on improper legal advice by Proskauer, and in turn Joao in his lead technological role, that foreign inventors could not be listed until their immigration status was adjusted leading to further erroneous billings by Proskauer for frivolous immigration work. This resulted in the failure of the patents to include their rightful and lawful inventors; and,
- d. Failed to ensure that the patent applications for the technologies, contained all necessary and pertinent information relevant to the technologies and as required by law; and,
- e. Falsified billing statements and transmitted documents, and,



f. Falsified patent documents and changed the contents of patents prior to filing so as to make the Company patents weak and inaccurate, so as to file patents in his own name that would succeed upon the Companies patents failing. That Mr. Joao who was contracted to procure patents for the Company has now applied for 70+ patents in his own name, many of which appear to be ideas learned while representing the Company.

g. That due to the discovery of many of the above described events the Company's lead investor Crossbow Ventures (a referral of Proskauer Rose) of West Palm Beach, Fla., pulled funding on the Company.

Lastly, the negligent actions of Joao, MLGS and Proskauer resulted in and were the proximate cause of loss to the Company; today, the Company's processes are believed to be on digital camera's, DVD's and virtually all Internet and Broadcast streams of video; true copies of exhibits and witnesses are available on request and/or I will, on behalf of the Company, present them according to proof at commencement of investigation into this General Complaint.

Due to the highly sensitive nature of the patent and copyright materials, exhibits and witnesses will be provided once formal protections have been established in regard to this complaint.

Very truly yours,

IVIEWIT HOLDINGS, INC.

By: : Electronic Signature

Eliot I Bernstein
561.364.4240
President

Electronic Signature for P. Stephen Lamont by Eliot I. Bernstein his attorney -in-fact

P. Stephen Lamont
Chief Executive Officer

RAYMOND A. JOAO, ESQ.
122 BELLEVUE PLACE
YONKERS, NY 10703
(914) 969-2992

April 8, 2003

BY FEDERAL EXPRESS

Thomas J. Cahill, Esq.
Chief Counsel
Departmental Disciplinary Committee
Supreme Court, Appellate Division
First Judicial Department
61 Broadway
New York, New York 10006
Attention: Mr. Joseph G. Wigley

Re: Complaint of Mr. Eliot I. Bernstein
Docket No. 2003.0532

Dear Mr. Cahill:

This is my response, pursuant to 22 NYCRR § 605.6(d), to the Complaint of Eliot I. Bernstein, president of Iviewit Holdings, Inc. ("Iviewit"), dated February 26, 2003 ("the Complaint").

I hereby deny each and every one of the general and specific allegations in the Complaint. Those allegations are simply untrue.

In addition, the allegations in the Complaint are vague and unsubstantiated and do not allege specific violations of the Disciplinary Rules of the Code of Professional Responsibility.

APR 08 2003
10:21 AM
FEDERAL EXPRESS
10006 NY NY

Finally, I believe that the Complaint was filed in retaliation to an action that Proskauer Rose LLP ("Proskauer") has brought against Iviewit to recover substantial unpaid legal fees.

For the reasons set forth below, I respectfully request that the Office of Chief Counsel recommend to the Committee that the Complaint against me be dismissed without referral.

I. THIS ANSWER IS BEING FILED WITHOUT HAVING ACCESS TO THE PERTINENT IVIEWIT PATENT FILES.

I do not have access to any of the Iviewit files and documents, retainer agreements (where applicable) or client correspondences that Mr. Bernstein apparently relied on in order to file the Complaint.

Upon receiving the Complaint, I contacted Arnold Klein, Esq., a partner of the Mineola, New York law firm of Meltzer, Lippe & Goldstein and requested access to its files for Iviewit, including any retainer agreements. During the time period of the Complaint, I was Of Counsel and Head of the Intellectual Property/Technology Rights Group of Meltzer, Lippe, Goldstein & Schlissel, the predecessor law firm of Meltzer, Lippe & Goldstein (collectively, "MLG"). Mr. Klein informed me, however, that MLG no longer had its Iviewit files because, in or about May of 2000, it sent its original files to the Wisconsin office of the law firm of Foley & Lardner.

I then contacted Foley & Lardner attorney Steven Becker who informed me that its original Iviewit files had been transferred to the Los Angeles Office of Blakely, Sokoloff, Taylor & Zafman.

Upon contacting Blakely, Sokoloff, Taylor & Zafman, I was informed by Farzad Amini that Blakely, Sokoloff, Taylor & Zafman is Iviewit's patent counsel, and he refused to provide me with a copy of any documents in the Iviewit files that are pertinent to the Complaint without Iviewit's approval.

In view of my inability to obtain a copy of any documents in the Iviewit files that are pertinent to the Complaint, I must qualify all of the responses relating thereto as being based on my memory and/or from research I performed on publicly accessible computer databases.

II. MY BACKGROUND AND PERTINENT INFORMATION REGARDING MYSELF.

I have BS and MS degrees (1982 and 1984, respectively) in Electrical Engineering from the Columbia University School of Engineering and Applied Science. I have approximately six years of engineering work experience for defense contracting firms where I worked on various electrical and electronic systems relating to radar, sonar, microprocessor-based digital computers, and electronic warfare threat detection systems.

Thomas J. Cahill, Esq.
April 8, 2003
Page No. 4

I received my JD degree from the St. John's University School of Law in 1990. I was admitted in the Second Department in January 1991. I am admitted to practice before the United States Patent & Trademark Office as a Patent Attorney.

In 1999, I received an MBA in Finance from Baruch College of the City University of New York. I am currently enrolled in an MS Marketing program at Baruch, and I expect to receive that degree in due course.

In 1992, I began filing patent applications for my own inventions. To date, I have been awarded fifteen (15) United States Patents and have numerous other patents pending. I am currently devoting my full-time efforts towards commercializing my various intellectual properties.

On July 18, 1996, I filed a patent application in my name that disclosed a remote-controlled control, monitoring and/or security apparatus and method for vehicles, motor vehicles, marine vessels and vehicles, aircraft, recreational vehicles, residential premises and/or commercial premises. This patent application was allowed and was issued as United States Patent No. 5,917,405 (the "405 Patent") on June 29, 1999. A true copy of the 405 Patent is attached hereto as Exhibit A.

Among the many things disclosed in the 405 Patent is the use of a video recording device or a camera for providing respective video information, a picture, or an image, to a device by transmitting the respective video information, picture, or image, on or over a communication network or system. The communication network or system can be any

Thomas J. Cahill, Esq.
April 8, 2003
Page No. 5

communication network or system. The 405 Patent also discloses transmitting video information, a picture, or an image, on or over the Internet and/or the World Wide Web.

The 405 Patent also discloses the use of an audio recording device for providing audio information to a device by transmitting the audio information on or over a communication network or system. The communication network or system can be any communication network or system. The 405 Patent also discloses transmitting audio information on or over the Internet and/or the World Wide Web.

The 405 Patent also discloses an apparatus and method which can be used to any one or more of control, activate, deactivate, enable, and/or disable, any one or more of the vehicles, premises, systems, equipment systems, subsystems, equipment, devices, components, or appliances, disclosed in the 405 Patent via, on, or over, a communication network or system. The 405 Patent also discloses controlling any one or more of a video recording device, a camera, an audio recording device, a microphone, a tape recorder, etc., via a communication network or system. The 405 Patent also discloses performing any of the control, activation, deactivation, enabling, and/or disabling, operations on or over the Internet and/or the World Wide Web.

In April 2002, I received significant media attention and recognition for the 405 Patent for a use of the technology in controlling and/or monitoring aircraft remotely and for providing the capability of obtaining video information from an aircraft and/or for providing the capability of obtaining audio information from an aircraft. A copy of a

Thomas J. Cahill, Esq.
April 8, 2003
Page No. 6

New York Newsday article, dated April 22, 2002, is representative of the attention that I received for the 405 Patent and is attached hereto as Exhibit B.

III. MY EMPLOYMENT RELATIONSHIP WITH MELTZER, LIPPE, GOLDSTEIN, & SCHLISSEL

In February of 1999, I joined the law firm of Meltzer, Lippe, Goldstein & Schlissel, the predecessor of MLG, in an Of Counsel capacity and as Head of the Intellectual Property/Technology Rights Group. I joined that firm to assist its efforts to restart an Intellectual Property Group after the previous group, which included Kenneth Rubenstein, Esq., had left in 1998 to join the Proskauer firm. I resigned from Meltzer, Lippe, Goldstein & Schlissel on April 19, 2000.

I was never a partner at Meltzer, Lippe, Goldstein & Schlissel or its successor firm, MLG. I have never represented myself as being a partner of Meltzer, Lippe, Goldstein & Schlissel or its successor firm MLG, and I am not aware of any such misrepresentations made to that effect to Iviewit by any third party.

Similarly, at no time was I ever a partner of Proskauer. I have never represented myself as being a partner of Proskauer, and I am not aware of any such misrepresentations made to that effect to Iviewit by any third party.

In or about February or March 1999, Mr. Rubenstein, who at the time was at Proskauer, contacted me to say that he was referring Eliot Bernstein to me because Mr. Bernstein had invented a new process or technique for compressing image and/or video information. Shortly thereafter, I had a conversation with Mr. Bernstein who informed

me that he had invented a new process or technique for performing a compression of an image file, that he was in the process of forming a company, and that he wanted to file a patent application for his invention. Mr. Bernstein asked me various questions concerning my experience and qualifications. Since these were questions which a competent businessman would and should ask in qualifying an attorney and especially a patent attorney, I provided him with information concerning my credentials and experience. I informed Mr. Bernstein that I had substantial experience in drafting and prosecuting high technology inventions and especially those relating to Internet and/or World Wide Web technologies. I also informed Mr. Bernstein that I was an inventor and that I had number of patents and patents pending for numerous inventions of my own. I described to Mr. Bernstein the general subject matter relating to my then soon-to-be issuing 405 Patent and some of its various features regarding transmitting video information *via* the Internet and/or the World Wide Web. I also explained to Mr. Bernstein that I specialized in helping inventors and start-up companies in developing patent portfolios to help them build and sustain a competitive advantage.

Sometime after the issuance of the 405 Patent on June 29, 1999, I informed Mr. Bernstein of the issuance of that patent and its patent number. I had discussed the 405 Patent with Mr. Bernstein from time to time. I would sometimes use my own patents as a teaching tool to show how non-provisional applications can be drafted and how inventive activities should be pursued in order to build upon innovations. Mr. Bernstein told me that he had read the 405 Patent.

With regard to payment for legal services, Mr. Bernstein informed me that, because Iviewit was in the start-up phase, he would only be able to pay, to the best of my recollection, from between \$3,000 and \$3,500 for a patent application. I informed him that this financial limitation would not be acceptable to Meltzer, Lippe, Goldstein & Schlissel in view of the effort and time typically required to prepare such an application.

On account of the inability of Iviewit to pay for a patent application, I informed Mr. Bernstein that I could instead prepare and file a provisional patent application. I explained that, by filing a provisional patent application, he could at least receive a "patent pending" status for his invention. In this regard, I told Mr. Bernstein that a provisional patent application is not a true patent application, but rather a so-called "time stamp". It is not a true patent application because no patent can ever issue from it. Rather, it is a priority document to enable an inventor to obtain "patent pending" status for an invention for a one-year period. In order to obtain a patent, an inventor must file a non-provisional patent application within one year of the provisional patent application filing date and claim the benefit of the priority of the previously filed provisional application. If a non-provisional application is not filed within the required one year time period, the ability to claim the priority to the filing date of the provisional application is forfeited. A priority date is key in determining patentability of an invention, as it is the date upon which the prior art relating to an invention is determined.

Upon Mr. Bernstein's insistence that he needed "patent pending" status to protect his invention, and given his financial constraints, I informed him that I would draft a

provisional patent application that would include only the information that he provided to me. I also informed him that I would prepare the first provisional patent application in the format of a more detailed non-provisional patent application for about \$3,000. I further informed Mr. Bernstein that Meltzer, Lippe, Goldstein & Schlissel and I would only undertake such a task if he signed a Retainer Agreement acknowledging that he understood the nature of a provisional patent application and that he agreed that I would only prepare a provisional application and no more. Mr. Bernstein agreed to these terms by signing a written Retainer Agreement, which MLG no longer has.

In the ensuing months, Mr. Bernstein came up with additional ideas for which he wanted to file patent applications. Provisional patent applications were filed for each of these alleged inventions as well.

In an attempt to ascertain the identity of the applications prepared and/or filed by me, on behalf of Iviewit, I conducted research using publicly accessible information. To the best of my knowledge, I prepared and/or filed the following eight provisional patent applications:

<u>Filing Date</u>	<u>Provisional Application Serial No.</u>
March 24, 1999	60/125,824
June 3, 1999	60/137,297
June 7, 1999	60/137,921
June 29, 1999	60/141,440
August 2, 1999	60/146,726
August 19, 1999	60/149,737
September 22, 1999	60/155,404
December 8, 1999	60/169,559

Thomas J. Cahill, Esq.
April 8, 2003
Page No. 10

Some of the above provisional patent applications were prepared in the more detailed format of a non-provisional patent application, while others were filed in a brief invention disclosure format. Each application was filed with Mr. Bernstein's direction, knowledge, and approval.

On March 10, 2000, pursuant to Mr. Bernstein's directions and within the required one-year time period, I filed a non-provisional patent application claiming priority to the March 24, 1999 provisional patent application. This non-provisional patent application was assigned U.S. Patent application Serial No. 09/522,721.

On or before March 24, 2000, I also recall filing a Patent Cooperation Treaty ("PCT") application with the United States Patent & Trademark Office. I have been unable to locate any information regarding this PCT application.

A PCT application is not a true patent application, *i.e.* it cannot issue as a patent unless an application is made to enter a national or regional stage for a particular country or region, respectively. Instead, a PCT application can be described, in a simple manner, as being a document that can be relied upon for priority in order to file a patent application in any desired number of PCT signatory countries or regions throughout the world. In essence, a PCT is a "time stamp" that can allow an inventor or applicant to file patents in any one or more of the 85 plus national patent offices (countries) or regional patent offices, which are signatories of the PCT Treaty, for up to 30 months from the original patent application filing date (*i.e.* an earliest filed and claimed provisional or non-provisional application). In effect, the PCT application allows an inventor to secure

an option to file patents in the signatory countries or regions for generally up to 30 months from the earliest application priority date. If no national or regional application is filed for a particular country or region within that 30 month time period, the PCT application priority right is forfeited as to those countries or regions for which filings had been foregone.

IV. MY PROCEDURE IN PREPARING AND FILING A PROVISIONAL OR NON-PROVISIONAL PATENT APPLICATION.

I follow a standard procedure in preparing and filing a patent application. Upon receiving an invention disclosure and/or meeting with an inventor, I draft the patent application. Depending upon the format of the application, I prepare a draft document and transmit a copy of it to the inventor and await comments or revisions. I then review those comments or revisions from a technical and legal standpoint. If I make changes to the first draft, I send the revised, second draft to the inventor for his or her approval. This process is repeated as necessary until the inventor approves of the final form of the application and instructs me to file the document. When a provisional patent application was to be filed from an invention disclosure, this procedure may or may not be followed. Only upon receiving the inventor's final approval to file the document, would I then file the approved version of the document as the respective provisional or non-provisional patent application.

I followed this procedure, when applicable, with regard to Mr. Bernstein's and Iviewit's patent applications, whether they were provisional, non-provisional, or PCT, in nature.

V. RESPONSES TO THE ALLEGATIONS OF THE GENERAL COMPLAINT

This section addresses the allegations set forth in the Complaint. All of the allegations accusing me of misconduct or a failure to use reasonable care are denied. Further, these allegations lack a factual basis and are false.

On page 1 of the Complaint, it is alleged that I was initially misrepresented to Iviewit as being a partner of Proskauer and that I was allegedly a partner of Meltzer, Lippe, Goldstein & Schlissel. This allegation is false. Neither I nor anyone else, to my knowledge, represented to either Iviewit or Mr. Bernstein that I was a partner of Proskauer or a partner of Meltzer, Lippe, Goldstein & Schlissel.

On page 2 of the Complaint, Mr. Bernstein alleges that he "engaged the services of Proskauer and in turn Joao, among others, through an engagement letter" attached as Exhibit "A". I did not receive a copy of this alleged engagement letter when the Office of Chief Counsel sent me the Complaint. Further, I am not aware of any arrangement between Proskauer and its clients that would have engaged either Meltzer, Lippe, Goldstein & Schlissel or myself. As I stated earlier, Mr. Bernstein executed a Retainer Agreement with Meltzer, Lippe, Goldstein & Schlissel for the purpose of having me

Thomas J. Cahill, Esq.
April 8, 2003
Page No. 13

prepare his March 1999 provisional patent application. This Retainer Agreement did not include Proskauer.

Mr. Bernstein's allegation that "Joao upon viewing the technologies developed by Bernstein, and held by the Company, realized the significance of the technologies, its various applications to communications networks for distributing video data images and for existing digital processes, including, but not limited to digital cameras, digital video disks (DVD), digital imaging technologies for medical purposes and digital video", to the extent understood, is denied in its entirety. Mr. Bernstein's alleged innovations involved digital image file compression techniques and/or digital video file compression techniques which were directed to what could be described to a lay person as a high tech processing or development of a digital rendition of an image or a video. As described above, various applications of transmitting images or video in a communication network were invented by myself as early as 1996. I have never ventured into the field of video file compression or image file compression. Further, Mr. Bernstein was aware of my 405 Patent as early as the summer of 1999. I deny appropriating any of Iviewit's alleged technologies.

I deny any allegations that malfeasances were perpetrated against Iviewit. I further deny that any fraud was perpetrated by myself against the U.S. Patent and Trademark Office.

VI. RESPONSES TO THE SPECIFIC ALLEGATIONS OF THE GENERAL COMPLAINT

I deny the allegation that I did not use reasonable care in performing legal services for either Iviewit or Mr. Bernstein. At all times, I provided Iviewit and Mr. Bernstein with the highest degree of care and attention.

My responses to each of the specific allegations are provided below.

A. I deny the allegation that I failed to take reasonable care to ensure that the intellectual property of Iviewit was protected. To the contrary, to the best of my recollection and through independent research, without having access to the Iviewit files, during the period from March 1999 through March 2000, I, through Meltzer, Lippe, Goldstein & Schlissel, filed eight provisional patent applications for Iviewit or Mr. Bernstein. These eight provisional patent applications are identified below:

<u>Filing Date</u>	<u>Provisional Application Serial No.</u>
March 24, 1999	60/125,824
June 3, 1999	60/137,297
June 7, 1999	60/137,921
June 29, 1999	60/141,440
August 2, 1999	60/146,726
August 19, 1999	60/149,737
September 22, 1999	60/155,404
December 8, 1999	60/169,559

During the same period, I, though Meltzer, Lippe, Goldstein & Schlissel, and pursuant to Mr. Bernstein's direction, filed a non-provisional patent application corresponding to, and claiming the benefit of the priority of, the March 24, 1999

Thomas J. Cahill, Esq.
April 8, 2003
Page No. 15

provisional patent application. This non-provisional patent application was filed on March 10, 2000 and was assigned U.S. Patent application Serial No. 09/522,721.

Pursuant to Mr. Bernstein's direction, I also filed a PCT application to claim priority to the March 24, 1999 provisional patent application on or before March 24, 2000.

I performed all reasonable steps to ensure that Iviewit's intellectual properties were protected in accordance with Mr. Bernstein's instructions. In any event, the Complaint does not allege what I did or failed to do that has left Iviewit's intellectual properties unprotected or at jeopardy.

B. I deny the allegation that I failed to and/or inadequately completed work regarding patents, copyrights and trademarks. First, Mr. Bernstein or Iviewit never asked me to perform any services with regards to copyrights and/or trademarks. Second, all the work that I performed was provided to Mr. Bernstein and, in certain instances to Mr. Brian Utley, then CEO of Iviewit, in a timely manner for review, for any suggestions, and for edits and/or revisions. I caused no provisional patent application, non-provisional patent application, and/or PCT application, to be filed without their approval. In instances when an invention disclosure was filed as a provisional patent application, in order to obtain the earliest possible filing date for the alleged invention, such filings also were made pursuant to their direction and with their knowledge and approval beforehand. Further, I never received any complaints regarding my work product and/or the patent

filing strategies being utilized. In any event, the Complaint does not allege how I allegedly failed to and/or inadequately completed work.

C. I deny the allegation that I failed to list proper inventors. At no time did Mr. Bernstein or any other person associated with Iviewit mention that others besides Mr. Bernstein were inventors of, or involved in the conception or reduction to practice of, the compression technologies that formed the basis for Iviewit's provisional patent applications, the non-provisional patent application, and the PCT application. To the contrary, Mr. Bernstein claimed sole inventorship for all provisional patent applications filed on Iviewit's behalf with the exception of, to the best of my recollection, one such application that also named Mr. Utley as an inventor. To the best of my recollection, I do recall Mr. Brian Utley being named as an inventor in a provisional patent application that may have been the application filed in December 1999. In this instance, I was specifically told that Mr. Utley was to be a named co-inventor of the technology disclosed in the application. Mr. Bernstein always had indicated and led me to believe that he was the only or sole inventor of the pertinent technology except in the instance when Mr. Utley was a named co-inventor on the pertinent patent application. I do not recall any other inventors being brought to my attention. Contrary to the allegations in the Complaint, Mr. Bernstein appears to continue his assertions to the present time that he is the sole inventor of the Iviewit technology. I attach hereto as Exhibit C a copy of a web page obtained from the Iviewit web site at www.iviewit.com, wherein Mr. Bernstein is described as the "Inventor of the I View It concept".

If, in fact, any foreigners or foreign nationals were co-inventors with Mr. Bernstein during the time when I represented Iviewit, such information was concealed from me. There was simply no good reason for Mr. Bernstein to have withheld this information from me. Furthermore, in filing the non-provisional patent application of March 10, 2000, I believe that such filing would normally include a Declaration by Mr. Bernstein attesting to the fact that he was the only or sole inventor of the invention disclosed therein. At the time of the filing of the March 10, 2000 non-provisional patent application, Mr. Bernstein again failed to mention any other and, in particular, any foreign inventors. This particular allegation is the first notice to me of these alleged two other inventors.

I further was unaware that any advice was allegedly being sought regarding any foreign inventors and the ability to name any such individuals as inventors in any patent application. I was also unaware that any alleged advice was being provided or that any alleged immigration work for any alleged foreign national(s) was being provided by Proskauer. The Complaint is my first knowledge of these allegations.

Mr. Bernstein never told me that Iviewit's technology was invented by any foreign inventors. Further, I was unaware of any legal advice given to Bernstein that the "immigration status" of these "foreign inventors" had to be "adjusted" before they could be listed as inventors in any type of United States Patent application. A foreign inventor can be listed at any time in a United States Patent application regardless of immigration status.

Thomas J. Cahill, Esq.
April 8, 2003
Page No. 18

Each and every provisional patent application that was filed with the United States Patent and Trademark Office was duly filed and received by the Office as evidenced by the assigning of a U.S. Provisional Patent Application Serial Number to each application. Further, the one non-provisional patent application that also was filed with the United States Patent and Trademark Office was duly filed and received by the Office as evidenced by the assigning of a U.S. Patent Application Serial Number to that application. I left Meltzer, Lippe, Goldstein & Schlissel in April 2000 and thereafter no longer represented Iviewit or Mr. Bernstein. After leaving Meltzer, Lippe, Goldstein & Schlissel, I was not asked to file any other or subsequent patent applications on behalf of Iviewit, Mr. Bernstein or any other inventors of any alleged Iviewit inventions. Subsequent to leaving Meltzer, Lippe, Goldstein & Schlissel, I also had no responsibility regarding the PCT patent application.

D. I deny the allegation that I failed to ensure that the relevant patent applications that I was asked to file contained all necessary and pertinent information relevant to the technologies as required by law. Mr. Bernstein had agreed that I would file provisional applications as his development progressed. Those applications were prepared and filed and included all information which was provided by Mr. Bernstein for each respective invention disclosure. Each and every one of the filed applications, provisional and non-provisional, which I was entrusted to file were duly filed and received by the United States Patent and Trademark Office. Each and every patent application accomplished its intended purpose, that is, to establish the respective earliest possible filing dates and/or

priority dates. Further, to the best of my knowledge, the legal sufficiency of these applications were never challenged or objected to by the United States Patent and Trademark Office. Mr. Bernstein fails to state any evidence to the contrary.

A search of public international patent records at <http://guest:guest@ipdl.wipo.int> was performed by myself on March 13, 2003. The search identified five (5) separate PCT applications filed in the name of Iviewit. These Iviewit PCT applications, apparently filed by Foley & Lardner's Office in Wisconsin, are listed below by their PCT application Number and filing date:

<u>PCT APPLICATION NUMBER</u>	<u>FILING DATE</u>
PCT/US00/21211	August 2, 2000
PCT/US00/15602	June 7, 2000
PCT/US00/15408	June 2, 2000
PCT/US00/15406	June 2, 2000
PCT/US00/15405	June 2, 2000

A copy of the search results page is attached hereto as Exhibit D. A text copy of each of the above PCT applications, identified respectively as Exhibits E through I are also attached hereto. The priority claims made in the PCT applications shows that priority was claimed to each of the Iviewit Provisional applications with the exception of the U.S. Provisional Patent Application Serial No. 60/125,824 filed on March 24, 1999. Priority for U.S. Provisional Patent Application Serial No. 60/125,824 was, however, claimed in the PCT application filed on or about March 24, 1999, which application was transferred to Foley & Lardner. In this regard, the provisional application filings served

their intended purposes as priority documents establishing the respective priority dates for the alleged inventions disclosed therein.

E. I deny the allegation that billing statements and transmitted documents were falsified. The Complaint fails to identify what alleged falsifications took place.

F. I deny the allegation that patent documents were falsified or that the contents thereof were changed prior to filing. No information in any of the Bernstein/Iviewit patent applications was ever changed or omitted from any patent application prior to filing after the document had been approved for filing by Bernstein/Iviewit. For each application filed, the same protocol was used, Mr. Bernstein, and/or Mr. Utley when he was a named inventor, provided information to me usually in a very short disclosure document which, if I recall correctly, consisted of a description of the technology and/or the enumerated processing steps. In some instances, additional information may have also been conveyed verbally in conferences or meetings with Mr. Bernstein and/or Mr. Utley. In each instance, I would generate a document to be filed with the U.S. Patent and Trademark Office and would provide same to Iviewit for review. I would await any comments and instructions for revisions. Thereafter, I would receive instructions to file the pertinent document, either as a provisional patent application, a non-provisional patent application, and/or a PCT application. After the pertinent application was filed, Mr. Bernstein was provided with a complete copy of all filed papers. Mr. Bernstein and/or Mr. Utley never informed me of any such alleged omissions or changes to any filed application.

Thomas J. Cahill, Esq.
April 8, 2003
Page No. 21

I also deny the allegation that I filed patents in my own name “that would succeed upon the Company’s patents failing,” and I further deny the allegation that any of my inventions or patent applications would appear to be ideas learned while representing Iviewit.

Iviewit’s technology and its alleged inventions were in the image data file compression and video data file compression technical art areas. I have never claimed to have invented and/or have never filed any patent application in my name for any inventions for or relating to any image data file compression or video data file compression technology or technologies. As I noted above, I have invented and patented inventions involving the transmission of video or images on or over a communication network or on or over the Internet and/or the World Wide Web. My inventions did not address image file compression or video file compression simply because such data file compression was not necessary in my inventions. Mr. Bernstein was made aware of some of my inventions and, in particular my 405 Patent, which he had knowledge of dating back to the summer of 1999. In any event, the Complaint fails to identify which of my patents or pending patent applications appear to be allegedly based on ideas learned while I represented Iviewit. I never appropriated any ideas learned from Iviewit or Mr. Bernstein at any time.

To the contrary, while preparing this letter, I discovered that Mr. Bernstein may have appropriated ideas contained in my 405 Patent as his own after he retained Foley & Lardner as Iviewit’s new patent counsel. For example, compare PCT/US00/15602

Thomas J. Cahill, Esq.
April 8, 2003
Page No. 22

application at page 1, lines 7-8 (Exhibit F), which states "The present invention [ALSO RELATES] to a system and method for controlling a video device over a network" and at Page 2, lines 3-30, with the subject matter of my 405 patent (Exhibit A) at Col. 1, lines 5-16, in Claims 1, 4, 6, 7, 12, 13, 14, 15, 16, 18, 19 and 20, at Cols. 74 thru 78, in Figures 5B and 11B and the descriptions relating thereto at Cols. 28 thru 29 and at Cols. 49 thru 50, respectively, at Cols. 12 thru 13, at Cols. 22 thru 24, at Cols. 52 thru 53, at Cols. 56 thru 57, and at Cols. 69 thru Col. 70.

Please also note the text of PCT/US00/15602 at Page 2, line 40 to Page 3, line 3 wherein the document states in pertinent part:

Compression and other manipulation of the video data is optional, since such manipulation typically results in decreased resolution and definition. Furthermore, saving compressed files of video data is not required to provide enhanced playback of video data to users over the network. [WHILE] the exemplary embodiments are explained with reference to video signals, it is understood that a video signal may include corresponding audio signals therein. Alternatively, the corresponding audio signals may be processed through a different method.

The Chief Counsel is respectfully requested to note the gist of the above statement, that compression is optional, and that audio can be provided along with video. Please refer to the 405 Patent and Figures 5B and 11B and the descriptions relating thereto at Cols. 28 thru 29 and at Cols. 49 thru 50, respectively, at Cols. 12 thru 13, at Cols. 22 thru 24, at Cols. 52 thru 53, at Cols. 56 thru 57, and at Cols. 69 thru 70.

Please also refer to Exhibit F at page 6, lines 32-35 and please compare this passage with the 405 patent (Exhibit A) at Col. 74, lines 33-44.

Thomas J. Cahill, Esq.
April 8, 2003
Page No. 23

For the sake of brevity, I will stop at the above examples, although numerous other examples of my technology and disclosure finding its way into PCT/US00/15602, filed June 7, 2000, can also be identified if necessary.

I respectfully submit that the above instances of the apparent copying of certain aspects of my 405 Patent, an issued United States Patent, and a published document which Mr. Bernstein knew about and told me he had reviewed on at least one occasion, provide unequivocal support for my position that it was not me who obtained ideas from Iviewit, but rather, it was Mr. Bernstein or some other Iviewit individual who obtained ideas from my issued 405 Patent and sought to file a patent for an invention which was disclosed by me in a United States Patent application filed almost four years earlier and patented and issued almost one year prior to the filing date of PCT/US00/15602. Further, Mr. Bernstein would now have the Chief Counsel believe that he or others at Iviewit invented technology which brings video and audio over the Internet or the World Wide Web and that he or others at Iviewit also invented the idea of controlling video cameras remotely via the Internet or the World Wide Web. My 405 Patent speaks for itself. Mr. Bernstein's claim is simply untenable.

G. I have no knowledge regarding Crossbow Ventures or any of its investment decisions with regard to Iviewit.

Lastly, I disagree that any of my actions resulted in a loss to Iviewit. Upon information and belief, Iviewit, according to its web site, has multiple patent applications pending in the United States and abroad. A copy of the pertinent web page is attached as

Thomas J. Cahill, Esq.
April 8, 2003
Page No. 24

Exhibit J. On further information and belief, Iviewit has exercised its rights pursuant to its PCT applications in filing three (3) European patent applications and what is believed to be five (5) Australian patent applications. A copy of a public records search attached as Exhibit K indicates that these applications have been filed. The status of these applications is unknown to me. Clearly, however, Iviewit does have patent counsel who appears to be actively representing Iviewit in various patent matters.

On March 25, 2003, Iviewit was selected as a new company to take part in the Epoch Incubator project sponsored by IBM, O'Melveny & Meyers, Deloitte & Touché, Silicon Valley Bank and Zone Ventures. A copy of this relevant press release is attached hereto as Exhibit L.

In view of the foregoing, I respectfully request that the Chief Counsel recommend that the Complaint be dismissed without referral. In the event that the Chief Counsel needs additional information, I will willingly comply by providing same. In the further event that additional information concerning me is given to the Chief Counsel, I respectfully request an opportunity to respond to that information before the Chief Counsel makes a recommendation in this matter.

Sincerely,

Raymond A. Joao

DEPARTMENTAL DISCIPLINARY COMMITTEE
SUPREME COURT, APPELLATE DIVISION
FIRST JUDICIAL DEPARTMENT
61 BROADWAY
NEW YORK, N.Y. 10006
(212) 401-0800
FAX: (212) 401-0810

PAUL J. CURRAN, Esq.
CHAIRMAN
HALIBURTON FALES, 2D., Esq.
HON. THOMAS B. GALLIGAN
MARTIN R. GOLD, Esq.
DENIS MCINERNEY, Esq.
ROY L. REARDON, Esq.
STEPHEN L. WEINER, Esq.
SPECIAL COUNSEL

LAWRENCE J. BANKS
SALLY W. BERG
DOUGLAS W. BRANDRUP, Esq.
CHRISTOPHER E. CHANG, Esq.
ANN J. CHARTERS
BRIAN M. COGAN, Esq.
DENIS F. CRONIN, Esq.
TELESFORO DEL VALLE JR., Esq.
CHARLES E. DORKEY III, Esq.
PAUL F. DOYLE, Esq.
JUSTIN E. DRISCOLL III, Esq.
PATRICIA FARREN, Esq.
MARION T. ETHEREDGE
STEVEN N. FEINMAN, Esq.
ROSALIND S. FINK, Esq.
CHARLOTTE MOSES FISCHMAN, Esq.
BEATRICE S. FRANK, Esq.
MARANDA E. FRITZ, Esq.
WILLIAM A. GALLINA, Esq.
ROBERT L. HAIG, Esq.
RICHARD J. HOLWELL, Esq.
SUSAN M. KARTEN, Esq.
JOHN J. KENNEY, Esq.
DAVID G. KEYKO, Esq.
MYRON KIRSCHBAUM, Esq.
LENORE KRAMER, Esq.
WILLIAM FRANCIS KUNTZ II, Esq.
MICHAEL A. LACHER, Esq.
DEBORAH E. LANS, Esq.
MARVIN LEFFLER
BURTON N. LIPSHIE, Esq.
HENRIETTA LYLE
MARY B. MAGUIRE
CHARLES C. MARINO
DOUGLASS B. MAYNARD, Esq.
LAWRENCE D. MCGOVERN, Esq.
CHARLES G. MOERDLER, Esq.
MATHIAS E. MONE, Esq.
MERCEDES A. NESFIELD
JANE W. PARVER, Esq.
ANTHONY M. RADICE, Esq.
ANDREW W. REGAN, Esq.
TIMOTHY G. REYNOLDS, Esq.
MICHAEL J. ROSENBERG
REUBEN SAMUEL, Esq.
AUGUSTIN J. SAN FILIPPO, Esq.
SAMUEL W. SEYMOUR, Esq.
DANIEL E. SIFF, Esq.
MARIAN E. SILBER, Esq.
EUGENE P. SOUTHER, Esq.
JOHN L. WARDEN, Esq.
ERIC J. WARNER, Esq.
SUSAN WELSHER
COMMITTEE MEMBERS

THOMAS J. CAHILL
CHIEF COUNSEL
SHERRY K. COHEN
FIRST DEPUTY CHIEF COUNSEL
ANDRAL N. BRATTON
DEPUTY CHIEF COUNSEL
CHRISTINE C. ANDERSON
ROBERTA N. BERKWITS
ANGELA CHRISTMAS
NICOLE CORRADO
JORGE DOPICO
MADY J. EDELSTEIN
JEREMY S. GARBER
NAOMI F. GOLDSTEIN
JOSEPH J. HESTER
JUN HWA LEE
VITALY LIPKANSKY
STEPHEN P. MCGOLDRICK
JAMES T. SHED
EILEEN J. SHIELDS
JUDITH N. STEIN
RAYMOND VALLEJO
LA TRISHA WILSON
STAFF COUNSEL

April 16, 2003

PERSONAL AND CONFIDENTIAL

Mr. Eliot I. Bernstein
IVIEWIT
10158 Stonehenge Circle
Boynton Beach, FL 33437

Re: Matter of Raymond A. Joao, Esq.
Docket No. 2003.0532

Dear Mr. Bernstein:

We are forwarding herewith an answer to your recent complaint against the above-named attorney. If you disagree with the attorney's statement, please write us, telling us specifically how and why; if you have any documents substantiating your points of disagreement, forward them to us. Also, please tell us what has happened in regard to this matter since the time you filed the complaint.

If we do not hear from you within twenty (20) days, we may conclude that you agree with the attorney's statement.

All inquiries concerning this matter should be addressed to Joseph G. Wigley, Legal Assistant.

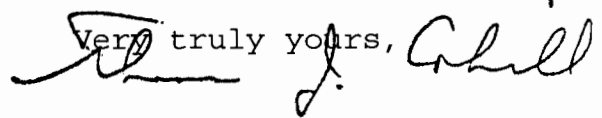
Very truly yours,

Thomas J. Cahill

TJC:adp/P:JGW/A:JNS
DC14 (F424/TB505)



IVIEWIT HOLDINGS, INC.

P. Stephen Lamont
Chief Executive Officer
Direct Dial: 914-217-0038

May 26, 2003

By Overnight Delivery

Thomas J. Cahill, Esq.
Chief Counsel
First Judicial Department Departmental Disciplinary Committee
61 Broadway, 2nd Floor
New York, New York 10006

Re: **Rebuttal of Raymond A. Joao, Esq. Response to Complaint of Iviewit Holdings, Inc., Docket 2003.0532**

Dear Mr. Cahill:

By way of introduction, I am Chief Executive Officer (Acting) of Iviewit Holdings, Inc. and its subsidiaries (collectively, "Company") with a background of which the Company invites you to view at <http://www.iviewit.com/management.htm>, and I write to rebut all those material denials and inconsistencies in the response of Raymond A. Joao, Esq. ("Respondent") to the Company's New York Bar Complaint of February 26 ("Complaint").

Moreover, and as Respondent has chosen to apprise you, the Company and Proskauer Rose LLP ("Proskauer"), are parties to that certain litigation titled Proskauer Rose LLP v. Iviewit.com, Inc. et. al., Case No. CA 01-04671 AB (Circuit Court of the 15th Judicial Circuit in and for Palm Beach County, Florida filed May 2, 2001) ("Litigation") that, as Respondent is aware, yet prefaces and attributes the Complaint to said Litigation, bears not one scintilla of relevance to the specific allegations contained in the Company's Complaint.

Furthermore, one more important inconsistency to correct is that the Company is not now nor has ever been a so called "compression" technology company, but rather is a designer and developer of video frame scaling and imaging technologies that more effectively enables third party compression whereby, in combination and among other things, said technologies have the capability of reducing the input and output requirements over any transmission network in combination with third party digitizing, filtering, encoding, and compression designs.



Thomas J. Cahill, Esq.
5/26/2003
Page 2

Additionally, in the opinion of the Company, the Company's technologies form the backbone of, are essential to, and provide a competitive threat, when combined with third party digitizing, filtering, encoding, and compression designs, to the multimedia patent pools known as MPEG 2 (digital compression according the digital television standard), MPEG 4 (another compression standard at a lower bit rate, and wherein interactive objects may be embedded), and DVD ("digital video disc") player-drive-codec and the discs themselves, where the essentiality of the Company's inventions are depicted herein by [Exhibit A](#); a one Kenneth Rubenstein of Proskauer Rose LLP, admittedly counsel to the organization as licensor of the MPEG pools, was the overseer of Mr. Joao's work at the Company and this will be an important point to recall when we trail the workings of Respondent, under the direction of Mr. Rubenstein.

Still further, from the benefit of the narrative and attached exhibits below, the Company shall prove beyond a reasonable doubt that Respondent: (I) engaged in a series of improprieties and deceptions with a one Christopher C. Wheeler, Esq., a Partner in the Boca Raton office of Proskauer in an attempt to deprive the Company of robust patent filings for the benefit of Respondent, clients of Mr. Wheeler and Proskauer,¹ and a one Kenneth Rubenstein; (II) engaged in a series of dishonesties, appearances of untrustworthiness, conduct involving dishonesty, fraud, deceit, and misrepresentation with, and under the direction of, one Mr. Rubenstein², a Partner in the New York office of Proskauer in an attempt to bury the Company's inventions that are a competitive threat to the above referenced multimedia patent pools of which Mr. Rubenstein holds the position of counsel, by self admission,³ and patent evaluator, and wherein Mr. Rubenstein: (a) personally profits as said patent evaluator by, to the best of the Company's knowledge, receiving a fee of Eight Thousand Five Hundred Dollars (\$8,500) per patent review⁴; (b) wherein Mr. Rubenstein counts as among his clients certain

¹ First Judicial Department Departmental Disciplinary Committee should be apprised of the fact that the Company has similarly filed, as it relates to Mr. Wheeler, a complaint with The Florida Bar Association wherein such complaint, response to said complaint, and the Company's rebuttal to said complaint are attached herein as [Exhibit B](#).

² First Judicial Department Departmental Disciplinary Committee should be apprised of the fact that the Company has similarly filed, as it relates to Mr. Rubenstein, a complaint with the New York State Bar Association wherein such complaint and response to said complaint are attached herein as [Exhibit C](#), as well as Mr. Rubenstein's deposition in the recent Litigation that is wholly irrelevant to this Complaint, but instructive for the various allegations set forth by the Company.

³ Deposition of Kenneth Rubenstein at 23, Proskauer Rose LLP v. Iviewit.com, Inc. et. al. Case No. CA 01-04671 AB (Circuit Court of the 15th Judicial Circuit in and for Palm Beach County, Florida filed May 2, 2001).

⁴ First Judicial Department Departmental Disciplinary Committee should be apprised of the fact that based on the number of patents in the MPEG 2, MPEG 4, and DVD pools when compared to the \$8,500 fee per patent, it is a fair approximation that Mr Rubenstein has at least personally profited, absent any sharing with his former or present employers, in the amount of approximately Five Million Seven Hundred Thousand Dollars (\$5,700,000) and that Mr. Rubenstein stands to at least personally profit in the future,



Thomas J. Cahill, Esq.
5/26/2003
Page 3

licensors and licensees of said patent pools, and receives remuneration as the billing Partner in representation of those clients by Mr. Rubenstein and Proskauer; and (c) wherein it is in the best personal, financial interest of Mr. Rubenstein to direct and engage with Respondent and Mr. Wheeler in said series of dishonesties, appearances of untrustworthiness, conduct involving dishonesty, fraud, deceit, and misrepresentation to remove the competitive threat of the Company's inventions to said multimedia patent pools, thereby securing his own personal gain and, perhaps, that of Proskauer; (III) engaged in a series of dishonesties, appearances of untrustworthiness, conduct involving dishonesty, fraud, deceit, and misrepresentation for his own account by personally filing numerous patent applications naming Respondent as inventor and attorney, many of which lay claim to content ideas stemming from the Company's inventions and included in business plans made available to Respondent⁵; (IV) by virtue of his actions in (III) thereby perpetrating a fraud upon the United States Patent and Trademark Office; and (V) by virtue of (I) through (IV) all to the detriment of the patent filings and fortunes of the Company and its stakeholders alike.

Accordingly, on behalf of the Company, and for ease of reference I insert the major allegations of the Complaint within the framework of The Lawyer's Code of Professional Responsibility of the New York State Bar Association,⁶ cross referencing Title 22 of New York Codes, Rules and Regulations⁷ ("NYCRR"), and shall cite specific documentation in exhibits attached hereto:

I. DR 1-102 [§1200.3] Misconduct.

A. The Company rebuts the denials of Respondent and realleges that Respondent had, during the period of representation of the Company from 1998 to mid 2000, and irrespective of at which date an engagement agreement was executed by and between Respondent and the Company, engaged in illegal conduct that adversely reflected on Respondent's honesty, trustworthiness, and fitness as an attorney.

More specifically, Mr. Wheeler introduced Respondent as a team member of Mr. Rubenstein, who as patent evaluator for multimedia patent pools has personally profited by some Five Million Seven Hundred Thousand Dollars (\$5,700,000) and stands to personally profit in the future by some Two Million Five Hundred Thousand Dollars (\$2,500,000) and has recruited Respondent to assist, the Company alleges, in the burying the Company's inventions, from Proskauer in late 1998. Moreover, Respondent under

absent any sharing with his present employer, of approximately Two Million Five Hundred Thousand Dollars (\$2,500,000) from these pools.

⁵ Royalties of which, if measured along the lines of the MPEG 2 patent pool, can represent upwards of Twelve Million Dollars (\$12,000,000) per annum.

⁶ Lawyer's Code of Professional Responsibility, New York State Bar Association (January 1, 2002)

⁷ 22 New York Code, Rules and Regulations.



Thomas J. Cahill, Esq.
5/26/2003
Page 4

the direction of Mr. Rubenstein: (I) receives, and acknowledges as proprietary and confidential, CD-ROMs, and proprietary and confidential process documents sent by the Company that describe the inventions; (II) logs onto the Company website, similarly acknowledging as proprietary and confidential, along with Mr. Rubenstein to view demonstrations of the Company's inventions; and (III) has discussions with inventors and management regarding the Company's inventions and business plans as attached herein as [Exhibit D](#), the timeline of which the Company does not agree and has reason to believe that most, if not all, the records of Respondent including, but not limited to, all facsimiles, electronic mail, and purported filed documents bear elements of fraud and deceit⁸.

Furthermore, in January 1999 the Company discovers that neither Respondent nor Mr. Rubenstein who, has recruited Respondent to assist, the Company alleges, in the burying the Company's inventions, are actually at Proskauer, by questioning their estate planning contact at Proskauer, and in turn Mr. Wheeler, as to why Mr. Rubenstein was not listed on the Proskauer website nor in the phone directory at Proskauer, that Respondent claimed Mr. Rubenstein and Respondent were in transition from Meltzer, Lippe, Goldstein & Schlissel, LLP ("MLGS") and that we would need to execute a retainer with MLGS and fund their work at MLGS until Mr. Rubenstein and Respondent would officially transfer to Proskauer. Accordingly, the Company was in need of retaining two firms (nearly four months elapsed after Respondent, under the direction of Mr. Rubenstein, was working on the Company's inventions that a retainer agreement is executed with MLGS) to the dismay of the Board of Directors ("Board") and investors, and all occurred after engaging Mr. Wheeler and Proskauer, awarding Proskauer an equity interest in the Company, and agreeing that Proskauer's bills would mainly be paid by future royalties from the patent pools overseen by Mr. Rubenstein and the content and technology clients of Mr. Rubenstein and Mr. Wheeler; thereafter, and almost overnight, the Proskauer directory lists Mr. Rubenstein (apparently, Respondent never transferred to Proskauer as represented by Mr. Wheeler), and shortly thereafter four other intellectual property attorneys from MLGS join Mr. Rubenstein at Proskauer.

Moreover, the Company makes note that from Respondent's response to the Complaint, he admits his start date at MLGS as February 1999⁹, in diametric opposition to what was represented to the Company¹⁰. Furthermore, given this time line of events concerning

⁸ The Company requests First Judicial Department Departmental Disciplinary Committee to direct Respondent and MLGS, and at their expense, deliver evidentiary materials pertaining, but not limited to, the original billing records, original electronic mails messages, and original facsimiles of Respondent during his representation of the Company, and of Mr. Rubenstein during his tenure at MLGS.

⁹ Raymond A. Joao, *Response to Complaint of Iviewit Holdings, Inc. Against Raymond A. Joao*, First Judicial Department Departmental Disciplinary Committee Docket 2003.0532 6 (April 8, 2003).

¹⁰ The Company requests First Judicial Department Departmental Disciplinary Committee to obtain evidentiary materials relating to the whereabouts of Respondent during the period of mid 1998 to February 1999, including but not limited to all files pertaining to the Company, facsimiles, telephone records, and



Thomas J. Cahill, Esq.
5/26/2003
Page 5

Mr. Rubenstein, the other MLGS attorneys transferring, and Respondent joining MLGS, it becomes strikingly unusual that Mr. Rubenstein and the other former MLGS attorneys pass on the patent prosecution work of the Company for their new employer, Proskauer, and pass it back to their former law firm, MLGS, and an attorney, in one Respondent, who seemingly has no connection to the former attorneys, or do Respondent and Mr. Rubenstein have a former connection¹¹?

B. Secondly, the Company realleges that Respondent engaged, with and under the direction of Mr. Rubenstein, in conduct involving dishonesty, fraud, deceit, and misrepresentation, wherein Mr. Rubenstein who has recruited Respondent to assist, the Company alleges, in the burying the Company's inventions.

More particularly, Mr. Joao in meetings, teleconferences, via facsimile, and via electronic mail, receives copies of all software and takes notes on entire processes and hardware components pertaining to the Company's inventions over a significantly, lengthy period of time, dating back to 1998, and stipulates a specific timeline of filing a provisional imaging patent in January 1999, a provisional video in March 1999, and a combined video and imaging provisional patent, shortly thereafter¹².

Later, factually, in face to face meetings, Respondent so thoroughly reviews the inventions that he creates variations on the Company's inventions during personal meetings with the inventors stating that to create said variations personally gave Respondent a complete understanding of the inner workings of the Company's inventions. Moreover, in early 1999, Respondent leaves the Florida home of Mr. Bernstein again stating that he has filed provisional patents on three (3) inventions (video scaling, image zoom, and a combination of the two processes) and will continue to file filings that are more robust as well as other ideas.

Unfortunately, in mid 1999, the inventors receive only one provisional patent application and Respondent states that he has not filed the other patents as he twice advised the Company that he had filed. Moreover, in May 1999, the Company is meeting with the technology department of Real 3D, an imaging, video, and 3D technology company then jointly owned by Intel Corp., Silicon Graphics, and Lockheed Martin, wherein at such

electronic mail messages, as his whereabouts may impact and further add to the Complaint, as well as the complaints against Mr. Rubenstein and Mr. Wheeler.

¹¹ The Company requests First Judicial Department Departmental Disciplinary Committee to require Respondent and Mr. Rubenstein to describe their relationship prior to the time of Respondent's introduction to the Company, said description of which shall include, but not be limited to, first point of contact with respect to the Company, correspondences pertaining to the referral, telephone records, electronic mail messages, and facsimiles.

¹² The Company requests First Judicial Department Departmental Disciplinary Committee to require Respondent to supply all travel records so that the Company may obtain true and correct dates of all his visits to Florida since from mid 1998 to the end of his representation of the Company.



Thomas J. Cahill, Esq.
5/26/2003
Page 6

meeting, the Real 3D technologists claim that when patents issue, each one of the three, may generate billions of dollars in revenues annually. Furthermore, as Respondent, purportedly scheduled to appear and participate telephonically, was found to have only protected one invention that the Company can prove is existent, the Company cannot make full disclosures on the other two inventions where, Mr. Wheeler, after the meeting, calls Mr. Rubenstein who has recruited Respondent to assist, the Company alleges, in the burying the Company's inventions, opines that no damage may result from the late filings as the protections of the invention rest on the invention date and not the filing dates; thereafter, Respondent, Mr. Wheeler, and Mr. Rubenstein schedule an immediate meeting with inventors Mr. Bernstein, Mr. Shirajee, and Mr. Rosario¹³, at the offices of Proskauer to fully re-disclose the missing two inventions. The Company notes at this time that Respondent denies meeting any other inventors, other than Mr. Bernstein in his response¹⁴ to the Company's Complaint.

Lastly, Mr. Wheeler holding such disclosures, as well as the original tape to be transcribed, which he keeps in Proskauer's safe, then sends such disclosures to Mr. Rubenstein for review and transfers copies to Respondent.

C. Third, the Company realleges that Respondent engaged in other conduct that adversely reflects on the Respondent's fitness as an attorney, whereby Mr. Bernstein investigates some of the claims of Respondent and Mr. Rubenstein, who has recruited Respondent to assist, the Company alleges, in the burying the Company's invention, and finds that, contrary to their representations, foreign inventors can be listed on U.S. patent applications and that it is only in the U.S. patent system that inventions are based on the invention date, but the same does not hold true in the international system of patent prosecution.

Moreover, once the re-disclosures are made and Respondent draws the documents, Mr. Shirajee and Mr. Rosario execute the inventions as inventors, but it becomes apparent that Respondent, under the direction of Mr. Rubenstein, never filed what was executed at the time, even failing to file the combined invention provisional filing until much later in 1999. Furthermore, at this time, Respondent begins losing provisional patents, his numbering system becomes bizarre, fails to bill for some fifty facsimiles sent to the Company, generates some fifty electronic mail messages that bear elements of fraud and deceit, submits patent documents with dates of which have been tampered, patent documents of which the dates have been blanked rendering it impossible to track the actual events, no evidence of filing stamps on said patent documents, and, when drafted by Respondent, provisional filings miss critical elements of the inventions, as attached

¹³ The testimony of Mr. Shirajee and other witnesses shall reveal that all inventors met with, signed provisional patent documents, and reviewed same prior to execution with Respondent.

¹⁴ Raymond A. Joao, *Response to Complaint of Iviewit Holdings, Inc. Against Raymond A. Joao*, First Judicial Department Departmental Disciplinary Committee Docket 2003.0532 16 (April 8, 2003).



Thomas J. Cahill, Esq.
5/26/2003
Page 7

herein as [Exhibit E](#).

II. DR 1-103 [§1200.4] Disclosure of Information to Authorities.

A. The Company realleges and incorporates by this reference herein, as though fully set forth, Section I Subsection A-C, inclusive. Moreover, the Company further realleges that Respondent possessed knowledge of a violation of DR 1-102 [§1200.3] that raises a substantial question as to the honesty of Mr. Rubenstein, Mr. Rubenstein's trustworthiness, Mr. Rubenstein's fitness as a lawyer, and who has recruited Respondent to assist, the Company alleges, in the burying the Company's invention, whereby Respondent failed to report such knowledge to a tribunal or other authority empowered to investigate or act upon such violation, as attached herein as [Exhibit F](#).

Still further, and by Exhibit F, the Company alleges Respondent's awareness of violations of Mr. Rubenstein during a meeting at Proskauer's New York office with a Steven Filipeck representing Huizenga Holdings pertaining to the Company's patent filings, and based on Mr. Filipeck's review of Respondent's, under the direction of Mr. Rubenstein, provisional work; Huizenga Holdings, Inc. was the initial investor in the Company and this meeting, wherein Mr. Rubenstein attests to the robustness of the filings but does not convince Mr. Filipeck, materially impacts future Huizenga investments which, as a result of the faulty provisionals, were never forthcoming..

III. DR 1-105 [§1200.5-a] Disciplinary Authority and Choice of Law.

A. The Company realleges and incorporates by this reference herein, as though fully set forth, Section I Subsection A-C, and Section II Subsection A inclusive. Furthermore, the Company further realleges that Respondent admitted to practice in New York State is subject to the disciplinary authority of that state, regardless of where the Respondent's misconduct occurred.

More specifically, Respondent, under the direction of Mr. Rubenstein, who has recruited Respondent to assist, the Company alleges, in the burying of the Company's inventions, traveled to the homes of Mr. Bernstein, the offices of the Company, and offices of Proskauer approximately three (3) times, all in Boca Raton, Fla., to receive technology disclosures, attend meetings, and deal with the day-to-day details of patent prosecutions, under the direction of Mr. Rubenstein.

IV. DR 4-101 [§1200.19] Preservation of Confidences and Secrets of a Client.

A. The Company realleges and incorporates by this reference herein, as though fully set forth, Section I Subsection A-C, Section II Subsection A, and Section III Subsection A inclusive. Wherein, "confidence" refers to information protected by the attorney-client



Thomas J. Cahill, Esq.
5/26/2003
Page 8

privilege under applicable law, and “secret” refers to other information gained in the professional relationship that the Company had requested be held inviolate and the disclosure of which would likely be detrimental to the Company, the Company further realleges that Respondent revealed, by using for Respondent’s own gain, confidences and trade secrets of the Company, to the disadvantage of the Company.

More specifically, Respondent as well as a patent prosecutor, and much to the Company’s surprise, is an inventor in his own right. Moreover, Respondent presently has numerous patents issued and patent applications pending since meeting the inventors, nearly eighty (80)¹⁵ in total, and where these inventions concern those allegedly learned through his engagement with the Company, the royalties, if measured along the lines of the MPEG 2 patent pool, can represent upwards of Twelve Million Dollars (\$12,000,000) per annum. Furthermore, in an in-exhaustive review of Respondent’s patents issued and pending that the Company has seen published on the URL at <http://appft1.uspto.gov/netahtml/PTO/search-bool.html> and under the search term Joao, reveals that Respondent, prior to his engagement with the Company, invents no discoveries containing video concepts, but during and after Respondent’s engagement with the Company, has a multiplicity of inventions containing video concepts, examples of which are attached herein as [Exhibit G](#).

Additionally, the Company alleges that Respondent made use of the Company’s business plan, conversations with the Company, white board notes at meetings, and other idea generating sessions to file a number of what the Company refers to as “content” patents, wherein said patents position Respondent favorably between the Company’s inventions and the end users of the Company’s original equipment manufacturer (“OEM”) potential licensees, as attached herein as [Exhibit H](#).

Furthermore, and by virtue of Respondent as an inventor as well as a patent prosecutor, the Company alleges Respondent has grave conflict of interests, when said conflicts are not disclosed to the Company prior to the commencement of disclosures, dissemination of Company business plan, provisional patent drafting, and the execution of an engagement agreement¹⁶, copies of which is attached herein as [Exhibit I](#) with no mention of Respondent’s invention activities and no disclosures of possible inventions that could be in competition with those of the Company and no conflict of interest checks conducted by MLGS; notably, in the opinion of the Company, given these considerations, Respondent should not have represented the Company’s patent prosecution process in

¹⁵ The Company requests First Judicial Department Departmental Disciplinary Committee to require Respondent to submit for the Company’s review each patent pending on file with the United States Patent and Trademark Office since mid 1998 so that the Company may further investigate the alleged misappropriations of Company trade secrets and patent pending inventions.

¹⁶ Factually, the parties acknowledge the execution of an engagement agreement as early as March 1999, however Respondent and MLGS have no record of that engagement agreement.



Thomas J. Cahill, Esq.
5/26/2003
Page 9

the first place.

Moreover, Respondent refers to his “405” patent, and the Company challenges Respondent to produce just one copy of any disclosure of this patent to the Company, in his response, and still further, the Company alleges that Respondent benefited from the Company’s inventions and business plan when viewing said “405” patent against a similar concept patent issued in 1996, United States Patent 5,513,244, copies of which are attached herein as [Exhibit J](#)¹⁷.

Still further, also attached herein as Exhibit J is a letter from a one Douglas Boehm of Foley & Lardner, Milwaukee, Wis. to Mr. Bernstein, where said letter was sent to the Company’s then President & Chief Operating Officer, a one Brian Utley, two hours earlier, advising the Company as to Respondent’s patent applications that compete and position themselves between the Company and its original equipment manufacturer (“OEM”) potential licensees; Foley & Lardner is the firm that the Company retained after representation by Respondent. At this point in time, Mr. Bernstein is incredulous at the prospect that Respondent is the holder of issued or pending inventions of which he may want to partner with the Company, and where these inventions concern those allegedly learned through his engagement with the Company, the royalties, if measured along the lines of the MPEG 2 patent pool, can represent upwards of Twelve Million Dollars (\$12,000,000) per annum.

Lastly, the Company questions as to why Respondent would file on behalf of the Company, the Company’s remote control application, now abandoned, for inventors Friedstein, Bernstein, Rosario, and Shirajee without disclosure of the prior art of his “405” patent, the Company’s abandoned provisional patent of which is attached herein as [Exhibit K](#), as the U.S. patent system relies to a great extent upon the applicant’s observance of a duty of candor toward the United States Patent and Trademark Office (“USPTO”), of which “[T]he chief requirement of this duty is that the applicant must disclose known prior art references relevant to the pending application.¹⁸”

V. DR 5-101 [§1200.20] Conflicts of Interest - Lawyer’s Own Interests

A. The Company realleges and incorporates by this reference herein, as though fully set forth, Section I Subsection A-C, Section II Subsection A, Section III Subsection A, and Section IV Subsection A inclusive. The Company further realleges that Respondent

¹⁷ For the truest picture of Respondent’s “405” patent, the Company requests that First Judicial Department Departmental Disciplinary Committee to secure the entire file, including but not limited to all amendments and continuations pertaining to the “405” patent to determine what malfeasances may have occurred pertaining to the history of this patent prosecution.

¹⁸ Martin L. Raderman, et.al. *Cases and Materials on Patent Law*, at 735, (West Group, St. Paul, Minn. 1998)



Thomas J. Cahill, Esq.
5/26/2003
Page 10

accepted and continued employment of the commercializations of his inventions when the exercise of professional judgment on behalf of the Company was affected by the Respondent's own financial, business, property, and personal interests, without the Company's consent to Respondent's representation after the non-existence of full disclosure of the implications of Respondent's conflicting interests, and where these inventions concern those allegedly learned through his engagement with the Company, the royalties, if measured along the lines of the MPEG 2 patent pool, can represent upwards of Twelve Million Dollars (\$12,000,000) per annum..

More specifically, the Company references the response¹⁹ of Respondent wherein he states that Respondent now devotes full time effort to the commercialization of his technologies, many of which are learned from the Company, it alleges, a copy of which is attached herein as [Exhibit L](#).

VI. DR 5-105 [§1200.24] Conflict of Interest; Simultaneous Representation.

A. The Company realleges and incorporates by this reference herein, as though fully set forth, Section I Subsection A-C, Section II Subsection A, Section III Subsection A, Section IV Subsection A, and Section V Subsection A inclusive. Moreover, the Company alleges that pursuant to DR 5-105, Respondent should have declined the "proffered" employment of his own intellectual property commercialization interests, and that Respondent's exercise of independent professional judgment in behalf of the Company was adversely affected by Respondent's continuance of said "proffered" employment, and where these inventions concern those allegedly learned through his engagement with the Company, the royalties, if measured along the lines of the MPEG 2 patent pool, can represent upwards of Twelve Million Dollars (\$12,000,000) per annum. (See [Exhibit L](#)).

B. The Company realleges that Respondent's employer at the time, MLGS failed to maintain records of Respondent's own intellectual property interests, and similarly failed to implement a system by which the proposed engagement with the Company was checked against Respondent's own intellectual property interests, and whereby the case of representation of the Company was a substantial factor in causing a violation of DR 5-105 by Respondent, and where these inventions concern those allegedly learned through his engagement with the Company, the royalties, if measured along the lines of the MPEG 2 patent pool, can represent upwards of Twelve Million Dollars (\$12,000,000) per annum..

VII. DR 5-108 [§1200.27] Conflict of Interest - Former Client.

¹⁹ Raymond A. Joao, *Response to Complaint of Iviewit Holdings, Inc. Against Raymond A. Joao*, First Judicial Department Departmental Disciplinary Committee Docket 2003.0532 4 (April 8, 2003).



Thomas J. Cahill, Esq.
5/26/2003
Page 11

A. The Company realleges and incorporates by this reference herein, as though fully set forth, Section I Subsection A-C, Section II Subsection A, Section III Subsection A, Section IV Subsection A, Section V Subsection A, and Section VI Subsection A-B inclusive. Moreover, the Company further realleges that Respondent, after the representation of the Company continued to represent himself in his intellectual property dealings in the same and substantially related matter in which Respondent's interests are materially adverse to the interests of the Company, and where these inventions concern those allegedly learned through his engagement with the Company, the royalties, if measured along the lines of the MPEG 2 patent pool, can represent upwards of Twelve Million Dollars (\$12,000,000) per annum.

B. The Company realleges that Respondent used the confidences and trade secrets of the Company to the detriment of the Company.

C. The Company realleges that without the consent of the Company, Respondent knowingly continued to represent himself in the same and substantially related matters in which Respondent and MLGS had previously represented the Company and: (I) Respondent's interests are materially adverse to the Company; and (II) Respondent had acquired information protected by section DR 4-101 [1200.19](B) that is material to the matter.

VIII. DR 7-101 [§1200.32] Representing a Client Zealously.

A. The Company realleges and incorporates by this reference herein, as though fully set forth, Section I Subsection A-C, Section II Subsection A, Section III Subsection A, Section IV Subsection A, Section V Subsection A, Section VI Subsection A-B, and Section VII subsection A-C inclusive. Furthermore, Company realleges that Respondent intentionally failed to seek the lawful objectives of the Company through reasonably available means permitted by law and the Disciplinary Rules.

More specifically, the work product of Respondent comes under question by the Company's management, its Board, and subsequent patent counsel, Douglas Boehm, Steven Beck, both under the direction of William Dick of Foley & Lardner (see teleconference transcript of [Exhibit E](#)). Moreover, questions concerning Respondent's work product continue to this day under review by Blakely, Sokoloff, Taylor & Zafman LLP, Los Angeles, Cal. (present patent counsel which billed the Company approximately \$50,000 to repair Respondent's irresponsible work) and Greenberg Traurig LLP, West Palm Beach, Fla. (independent patent review counsel which estimates that it will charge the Company \$250,000 to repair Respondent's irresponsible work) as they came under question at Foley & Lardner (who billed the Company approximately \$150,000 to rework and refile Respondent's irresponsible work).

IX. DR 7-102 [§1200.33] Representing a Client Within the Bounds of the Law.



Thomas J. Cahill, Esq.
5/26/2003
Page 12

A. The Company realleges and incorporates by this reference herein, as though fully set forth, Section I Subsection A-C, Section II Subsection A, Section III Subsection A, Section IV Subsection A, Section V Subsection A, Section VI Subsection A-B, Section VII subsection A-C, and Section VIII Subsection A, inclusive. Moreover, the Company further realleges that Respondent concealed and knowingly: (I) failed to disclose that which Respondent was required by law to disclose; (II) spoke falsehoods and presented false documents; (III) made false statement of law and fact; (IV) participated, under the direction of and with Mr. Rubenstein, who has recruited Respondent to assist, the Company alleges, in the burying the Company's invention, in the creation or preservation of documentation when Respondent knew that said documentation is false; (V) under the direction of and with Mr. Rubenstein had perpetrated a fraud upon a tribunal, the USPTO, without revealing the fraud to such tribunal; and (V) engaged in illegal conduct and conduct contrary to Disciplinary Rules.

More specifically, on Respondent's trip to Boca Raton, Fla for disclosure meetings with inventors Mr. Bernstein and Mr. Shirajee, and after several hours of consultations, Respondent, in the presence of Mr. Wheeler and Mr. Utey, informs Mr. Bernstein that foreigners could not be listed as inventors and instructs Mr. Bernstein to the immigration status of Mr. Shirajee and Mr. Rosario expedited in diametric opposition to Section 115 of the Patent Act,²⁰ a copy of which is attached herein as [Exhibit M](#).

B. Moreover, Respondent travels to Florida again to meet with inventors Mr. Bernstein, Mr. Shirajee, and Mr. Rosario to file the non-provisional application for U.S. Patent Application No. 09/522,721. Furthermore, the inventors instruct him on the invention and when complete, Respondent steals into the Company's research and development laboratory, wherein Mr. Shirajee observes him altering the materials for disclosures just made, including but not limited to the 09/522,721 patent, a copy of a taped conversation as transcribed is attached herein as [Exhibit N](#).

Subsequently, inventors Mr. Bernstein and Mr. Shirajee remove copies of Respondent's files left on one of the Company's computers, while Respondent crosses the hall to the offices of Proskauer to meet with Mr. Wheeler and print the patent documents.

Furthermore, upon his return to the Company's offices, Respondent holds a sealed envelope addressed to the USPTO asking Mr. Bernstein and Mr. Shirajee to execute blank pages that Respondent intends to file with the USPTO upon his return to New York.

Still further, inventors Mr. Bernstein and Mr. Shirajee refuse to execute documents without reviewing them, wherein Mr. Bernstein and Mr. Shirajee open Respondent's

²⁰ 35 U.S.C. Sec. 115 (1985).



Thomas J. Cahill, Esq.
5/26/2003
Page 13

sealed envelope, read the filings finding material changes, and again request that Respondent make changes to the documents. Thereafter, and once changed to his satisfaction, Mr. Bernstein, along with Company employees Jennifer Kluge and Erika Lewin, personally deliver the documents to the U.S. Post Office, and where further, the Company alleges, Respondent utilized his Power of Attorney granted by the Company, or some other means, to withdraw or block the mailed documents, and substituting his former erroneous filing²¹.

Lastly, this occurrence baffles the Company, as this application does not reside in any records that Respondent sent to subsequent patent counsel, Foley & Lardner; Foley & Lardner upon request of the files witness Respondent not sending all the filings, not sending matching filings, and sending a suspect Patent Cooperation Treaty filing known as 5865-10 as per the MLGS intellectual property docket attached herein as [Exhibit O](#), that is missing the final changes Respondent was asked to make and omits all the inventors, except Mr. Bernstein; the Company presents part of the disclosure given to Respondent pertaining to U.S. Patent Application No. 09/522,721 compared with Respondent's purported filing.

X. DR 9-102 [§1200.46] Preserving Identity of Funds and Property of Others; Fiduciary Responsibility; Commingling and Misappropriation of Client Funds or Property; Maintenance of Bank Accounts; Record Keeping; Examination of Records.

A. The Company realleges and incorporates by this reference herein, as though fully set forth, Section I Subsection A-C, Section II Subsection A, Section III Subsection A, Section IV Subsection A, Section V Subsection A, Section VI Subsection A-B, Section VII subsection A-C, Section VIII Subsection A, and Section IX Subsection A-B, inclusive. Furthermore, the Company alleges that Respondent failed to maintain required bookkeeping records for the seven (7) year period including, but not limited to copies of all retainer agreements with the Company and copies of all bills rendered to the Company, upon request by subsequent patent counsel, Foley & Lardner, a copy of which is attached herein as [Exhibit P](#).

Moreover, the Company realleges that Respondent through MLGS fails to transfer the original patent documents, leaving subsequent counsel to possess only copies, not originals, of which such copied documentation include: (I) filing stamps with dark spots covering the dates; (II) facsimiles portraying a transmission date of 1900; and (III) and Respondent's admission of his destruction of notes and other patent materials as

²¹ The Company requests First Judicial Department Departmental Disciplinary Committee to require Respondent and MLGS to supply signature pages for these filings.



Thomas J. Cahill, Esq.
5/26/2003
Page 14

evidenced in the July 31, 2000 teleconference transcript²², an example of which is attached herein as [Exhibit P](#),²³ and as to (I) and (II) were presented as [Exhibit E](#).

XI. Lastly, the negligent actions of Respondent resulted in and were the proximate cause of loss to the Company.

The history of the Company, literally back to the first day of discovery of the inventions, sees the allegations described in Defendant's Motion for Leave to Amend to Assert Counterclaim for Damages, Proskauer Rose LLP v. Iviewit.com, Inc. et. al., Case No. CA 01-04671 AB (Circuit Court of the 15th Judicial Circuit in and for Palm Beach County, Florida filed May 2, 2001) attached herein as [Exhibit Q](#), a motion of which stems from that certain Litigation that is wholly irrelevant to this Complaint, but is instructive for the alleged violations I to XI above, wherein after review by the Company's subsequent patents counsels, the work product of Respondent and overseen by Mr. Rubenstein, who as patent evaluator for multimedia patent pools has personally profited by some Five Million Seven Hundred Thousand Dollars (\$5,700,000) and stands to personally profit in the future by some Two Million Five Hundred Thousand Dollars (\$2,500,000), result in the causing of damages to the Company over a twenty year patent life, as described in the Company's projections across all distribution channels as evidenced by [Exhibit R](#) attached herein projected at a present value Ten Billion Dollars (\$10,000,000,000) of potential damages, and much in the way Respondent and Mr. Rubenstein envisioned; letters of Mr. Wheeler outlining to positive opinions of Respondent and Mr. Rubenstein pertaining to the Company's technologies are also attached as Exhibit R.

The Company further alleges that, once Respondent and Mr. Rubenstein saw the Company's inventions, Mr. Rubenstein sees the personal, financial need to bury these inventions, and recruiting Respondent as the executioner of the Company's inventions. Moreover, the Company's inventions, while certainly not end to end solutions are literally the backbone technology of MPEG and DVD, pose formidable competitive threats to those pools, and certainly pose a threat to Mr. Rubenstein's fee of \$8,500 per essential patent; Mr. Rubenstein counts among his clients both licensors (Alcatel) and licensees

²² Iviewit Holdings, Inc., *Transcription of Telephone Conference Conducted July 31, 2000* at 2-4 (unpublished manuscript, on file with the Company).

²³ At this juncture, the Company requests First Judicial Department Departmental Disciplinary Committee to conduct a full audit of Respondent's records at MLGS, as the Company is in receipt of checks personally executed by Respondent with no record of MLGS accounting department's consent, billing records missing material facsimile correspondence among the various parties, facsimile correspondence with missing headers, all documentation of which raises a specter of impropriety when viewing the history of Respondent's representation of the Company. Accordingly, the Company requests First Judicial Department Departmental Disciplinary Committee to secure from MLGS, at their expense, all originals documents, all notes, all checks showing both sides for account, all expense receipts, all facsimile records and phone records, all email logs of Respondent, **copies of all records from USPTO and WIPO filed by Respondent and MLGS**, and particularly, the March 1999 retainer agreement executed by and between Respondent on behalf of MLGS and the Company.



Thomas J. Cahill, Esq.

5/26/2003

Page 15

(Alcatel, C-Cube Microsystems, Divicom a unit of Harmonic) of MPEG evidenced by comparing his biography at http://www.proskauer.com/lawyers_at_proskauer/atty_data/4747 with MPEGLA licensors and licensees at <http://www.mpegla.com/>.

Furthermore, as to Respondent, and where his inventions concern those allegedly learned through his engagement with the Company, the royalties, if measured along the lines of the MPEG 2 patent pool, can represent upwards of Twelve Million Dollars (\$12,000,000) per annum.

To conclude, Mr. Cahill, and as Respondent would have you believe, this is NOT the Complaint of Eliot I. Bernstein, but of Iviewit Holdings, Inc. (a Delaware Corporation) funded in total of approximately Six Million Dollars (\$6,000,000) by prominent investors and entertainment professionals alike, including, but not limited to: Wayne Huizenga, Wayne Huizenga Jr., Alan Epstein, Esq. and Michele Mulrooney, Esq. of Armstrong Hirsch Jackoway Tyerman & Wertheimer of Los Angeles. Cal., Kenneth Anderson, CPA, Donald Kane (formerly Managing Director of Goldman Sachs), James Osterling, James Armstrong, Ellen DeGenres, Alan Young, Allan Shapiro (Atlas Entertainment), Mitchell Welsch (Vice President of UBS Paine Webber), and Jeffrey Friedstein (Vice President of Goldman Sachs), Caroline Prochotska Rogers, Esq. and many others (see Witness List of Exhibit S). Moreover, these allegations stem from legal reviews by Irell and Manella of Beverly Hills, Cal, Blakely Sokoloff Taylor & Zafman LLP of Los Angeles, Cal., Caroline P. Rogers, Esq., Greenberg Traurig LLP, and Steven M. Selz, Esq.

Lastly, Respondent's unfounded accusations of the Company's founder, Mr. Bernstein, weaken what little defense Respondent has against these claims, and by [Exhibit S](#), we present a witness list the individuals of which shall corroborate the Company's rebuttal in its entirety.

Finally, in the near future, the Company intends to: (I) file a claim with the Lawyers' Fund for Client Protection as a result of the alleged dishonest conduct in the taking of the Company's property, to wit, the irresponsible filing of provisional and non-provisional patent applications by Respondent; (II) fulfill its requirement to report the loss of property to an Attorney Disciplinary (Grievance) Committee; and (III) fulfill its requirement to submit a written statement to the District Attorney of New York County.

Sincerely,

IVIEWIT HOLDINGS, INC.

By:

P. Stephen Lamont
Chief Executive Officer (Acting)



EXHIBIT A



ESSENTIAL TECHNOLOGY – VIDEO CHAIN

PATENT POOLS: MPEG 2, MPEG 4, MPEG 7, DVD

Typical Video

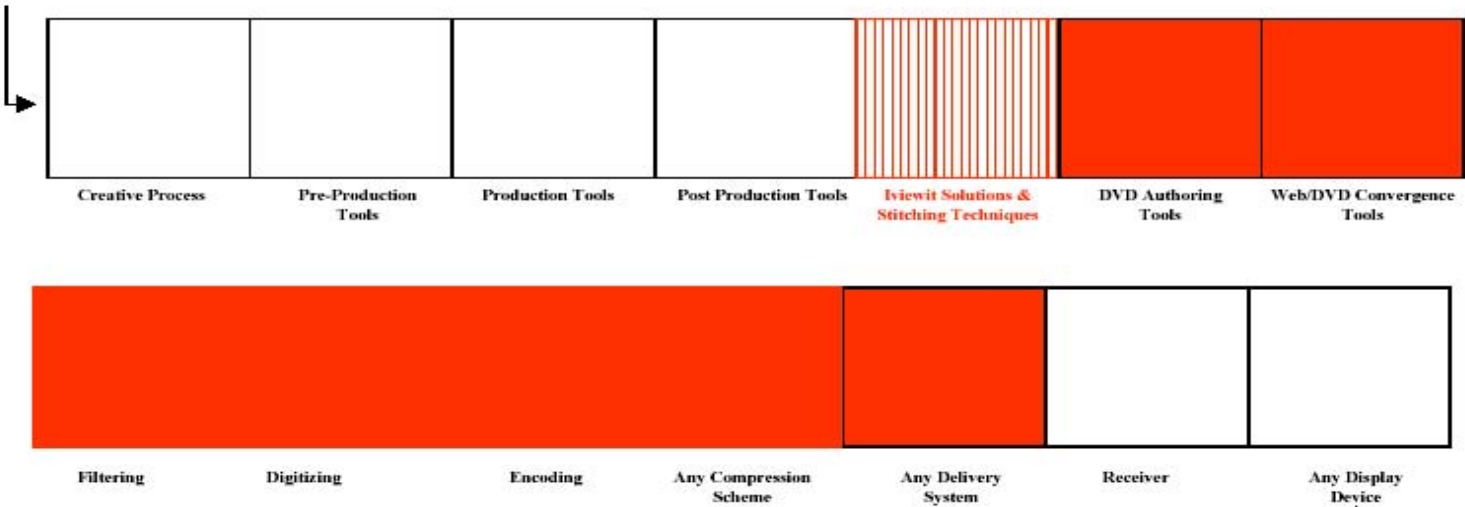

Key:  Better Enabled by Essential Iviewit Technology

- ↓
- HDTV
 - DTV
 - Cable STB
 - Satellite STB
 - ADC STB
 - DVD Players
 - Digital Cameras/Camcorders
 - PC

Proprietary & Confidential



EXHIBIT B



The Florida Bar
 650 Apalachee Parkway
 Tallahassee, Florida 32399-2300
 Toll Free 1-866-352-0707 (ACAP)

The Florida Bar
Internet Inquiry/Complaint Form

PART ONE: (See instructions, part one.)

Your Name: Eliot I Bernstein
 10158 Stonehenge Circle
 Boynton Beach, FL 33437
 561.364.4240

Attorney's Name: Christopher Wheeler
 Proskauer Rose LLP
 One Boca Place
 Suite 340 West
 2255 Glades Road
 Boca Raton, FL 33431-7360

And

P. Stephen Lamont
 4 Ward Street
 Brewster, NY 10509
 (845) 279-7710

ACAP Reference No. 03-13069

PART TWO: (See instructions, part two.) The specific thing or things I am complaining about are:
 See attached complaint sheet

PART THREE: (See instructions, part three.) The witnesses in support of my allegations are: [see attached sheet].

PART FOUR: (See instructions, part four.)

I did attempt to use ACAP to resolve this situation and Ted Littlewood suggested filing the complaint.

To attempt to resolve this matter, I did the following:

I called ACAP

PART FIVE (See reverse, part five.): *Under penalty of perjury, I declare the foregoing facts are true, correct and complete. I have read and understand the information on the reverse of this page and contained in the pamphlet "Complaint Against a Florida Lawyer." I also understand that the filing of a Bar complaint will not toll or suspend any applicable statute of limitations pertaining to my legal matter.*

_____- Eliot I Bernstein
 Signature

02/26/2003
 Date

_____- for P. Stephen Lamont by Eliot I. Bernstein his
 attorney -in-fact
 Signature

02/26/2003
 Date



IVIEWIT HOLDINGS, INC.

Part 2 – Florida Bar Complaint

February 25, 2003

Chief Disciplinary Counsel:

Eric M. Turner
Cypress Financial Center, Suite 835
5900 North Andrews Avenue
Ft. Lauderdale, Florida 33309
(954) 772-2245

Re: General Complaint against Christopher C. Wheeler on Behalf of Iviewit Holdings, Inc. (a Delaware Corporation) (“Company”)

Dear Sir or Madam:

By way of introduction, I am Founder and President (Acting) of the above referenced Company, and write to file a General Complaint against the following member of the Florida State Bar Association:

Christopher C. Wheeler
Proskauer Rose LLP
One Boca Place
Suite 340 West
2255 Glades Road
Boca Raton, FL 33431-7360
(561) 995-4702

Introduction

Christopher Wheeler, (hereinafter "Wheeler"), believed to be a resident of the State of Florida, and who at various times relevant hereto was a partner of Proskauer Rose LLP (hereinafter "Proskauer"), and who provided legal services to the Company.

Moreover, beginning on or about September of 1998, the Company, through its agent and principal, Eliot I. Bernstein ("Bernstein"), began negotiations with Proskauer with regard to Proskauer providing legal services to the Company the purpose of which was to develop and market specific technologies developed by Bernstein and two others, which technologies allowed for the scaling, enlargement, panning and zooming of digital images and video without degradation to the quality of the digital image due to what is commonly referred to as "pixelation", the delivery of digital video using proprietary scaling techniques, a combination of the image pan and zoom techniques and video scaling techniques, and the remote control of video and image applications.



Furthermore, Bernstein engaged the services of Proskauer and in turn Wheeler, among others, through an engagement letter a true copy of which I attach herein as Exhibit "A", to obtain multiple patents and oversee US and foreign filings for such technologies including the provisional filings for the technologies as described above, and such other activities as were necessary to protect the intellectual property.

Additionally, upon information and belief, Wheeler upon viewing the technologies developed by Bernstein, and held by the Company, realized the significance of the technologies, its various applications to communication networks for distributing video data and images and for existing digital processes, including, but not limited to digital cameras, digital video disks (DVD), digital imaging technologies for medical purposes and digital video, and that Wheeler designed and executed, sometimes for himself or others similarly situated, deceptions, improprieties, and, even in certain circumstances, outright malfeasances by the disingenuous insertion of his own interests or the interests of third parties, who were other clients of Proskauer and Wheeler, between the Company, as his client and together with its disclosed techniques, and the ultimate end users of its future OEM and other licensees, to the detriment and damage of the Company. Many of the malfeasances against the Company have also involved fraud against the US Patent and Trademark Office. The technologies were evaluated by a leading imaging company, Real 3D of Orlando FL and were estimated to be worth billions of dollars, due to there application to almost all digital imaging and video applications.

Finally, as a direct and proximate result of the conduct of Wheeler, Warner Bros/AOLTW ceased business relations with the Company to the damage and detriment of the Company; the Company more specifically stipulates Wheeler's actions and inactions directly below:

Specifics of General Complaint

Where the Company employed Wheeler and Proskauer for purposes of representing the Company to obtain multiple patents and oversee foreign filings for such technologies including the provisional filings for the technologies as described above, and that pursuant to such employment, Wheeler and Proskauer owed a duty to ensure that the rights and interests of the Company were protected, Wheeler and Proskauer neglected that reasonable duty of care in the performance of legal services in that they:

1. Misrepresented lawyer Raymond A. Joao by Christopher Wheeler, to the Board of Directors and investors of I View It, Mr. Joao presently of counsel to Dreier & Baritz, New York, N.Y. initially was represented as a Proskauer Rose attorney when he was not a member of such firm, but actually of counsel to one Meltzer Lippe Goldstein and Schlissel, Mineola, N.Y.
2. Misrepresented lawyer Kenneth Rubenstein by Christopher Wheeler as a member of Proskauer Rose, and presently a partner of Proskauer Rose, but at the initiation of contact, a partner of a one Meltzer Lippe Goldstein and Schlissel.
3. Failed to take reasonable steps to ensure that the intellectual property of the Company was protected; and,



4. Allowed the infringement of patent rights of the Company and the intellectual property of the Company by other clients of Proskauer and Rubenstein. Failed to submit to patent pools overseen by Rubenstein Iviewit patents for inclusion to such pools, including but not limited to MPEG 2, MPEG 4, and DVD and;
5. Failed to and/or inadequately completed work regarding patents, copyrights and trademarks; and,
6. Engaged in unnecessary and duplicate corporate and other work; and,
7. By redacting information from the billing statements regarding services provided so to as to give the appearance that the services provided by Proskauer were limited in nature, when in fact they involved various aspects of intellectual property protection; and,
8. By knowingly and willfully representing and agreeing to accept representation of clients in conflict with the interests of the Company, without either consent or waiver by the Company.
9. Submitting false resumes for President candidate Brian Utley. Wheeler who was a close personal friend of Utley, recommended to Bernstein and other members of the board of directors of Iviewit that Iviewit engage the services of Utley to act as President of Iviewit.com LLC based on his knowledge and ability as to technology issues. That at the time that Wheeler made the recommendation of Utley to the board of directors, that Wheeler knew that Utley was in a dispute with his former employer, Diamond Turf Products, as to the fact that Utley had misappropriated certain patents on hydro-mechanical systems, which he claimed for himself to the detriment of his then employer Diamond turf Lawnmower, thereafter Utley was fired from the Company and Diamond Turf Lawnmower was closed down due to Utley's malfeasances, contrary to the resume submitted by Wheeler to the Board on behalf of Utley which claimed that the Company continued as a large success due to Utley and his inventions. Additionally, Wheeler was fully aware of the fact that Utley was not the highly qualified "engineer" that Wheeler represented Utley to be, and that in fact Utley lacked any formal education as an engineer and in fact had no engineering degree, whatsoever. Further, Wheeler and Utley submitted a new and improved biography on Utley to Wachovia Bank for a Private Placement in which Utley is described as having graduated SF College, which is in direct contradiction to his resume submitted to the Company by Mr. Wheeler. That despite such knowledge, Wheeler never mentioned such facts concerning Utley to any representative of Iviewit and in fact undertook to "sell" Utley as a highly qualified candidate who would be the ideal person to undertake day to day operations of Iviewit and work on the patents acting as a qualified engineer. Based on the recommendations of Wheeler, as partner of Proskauer, the Board of Directors agreed to engage the services of Utley as President/COO other qualified candidates were not chosen based on Wheeler's misrepresentations of Brian Utley.
10. Failing to disclose and secure conflict waivers from the Company, that Mr. Wheeler had preformed prior legal work for Mr. Utley for the setting up of Mr. Utley's company, Premiere Consulting.
11. Recommendation by Mr. Wheeler and Mr. Utley of William Dick as patent counsel for I View It without disclosure that Mr. Dick had been involved in patent



- malfeasances with Mr. Utley's former employer Diamond Turf products. Mr. Dick subsequently aided and abetted Mr. Utley in writing patents into his own name of the Company's technologies, without assignment to the Company, sent to his home address and filed fraudulently with the US Patent and Trademark office.
12. Mr. Wheeler transacted stock to Tiedemann/Prolow, another referral friend of Mr. Wheeler, without proper documentation, nor Board approval.
 13. Knowing and willful destruction of Company records
 14. Failure to file Copyrights on behalf of I View It when billed for such
 15. Failing to list proper inventors of the technologies on the patents, and thereby submitting false and fraudulent patents to the US Patent and Trademark office based on improper legal advice by Wheeler that foreign inventors could not be listed until their immigration status was adjusted leading to further erroneous billings by Proskauer Rose for frivolous immigration work. This resulted in the failure of the patents to include their rightful and lawful inventors; and,
 16. Violation 4-1.1 - Lack of competence in all matters pertaining to patent and copyrights, in some instances outright lack of filing documents that were billed for
 17. Violation 4-1.3 - Lack of diligence in representing the Company - Failure to file copyrights and failure to secure protection for patents
 18. Violation 4-1.4 - Failure to communicate with Company to the detriment of the Company, and in certain instances communication of false materials to the Company. Submission of executive resumes with knowingly false information for MR. Brian Utley a close personal friend of Mr. Wheeler. Failure to communicate proper information regarding attorney's handling patents for Company.
 19. Violation 4-1.4 - Withholding of information to the detriment of the Company, examples would be failure to secure Copyright protection and adequate patents based on withholding either partial or entire pertinent information from both client company and the United States Patent and Trademark Offices
 20. Violation 4-1.6 - Violated Company Confidentiality of Information in multiple instances for the benefit of his firm and his firm clients and patent pools overseen by firm.
 21. Violation 4-1.7 - Violated Company in multiple conflicts of Interest between Company and firm clients and firm patent pools overseen by firm
 22. Violations of RULE 4-1.8 - CONFLICT OF INTEREST; PROHIBITED AND OTHER TRANSACTIONS - Accepted Company stock for his firm knowing of potential conflicts that were never revealed to the Company
 23. Violations of RULE 4-1.10 - IMPUTED DISQUALIFICATION - Quit working for Company because he was being investigated by Company in several of the above allegations and then filed frivolous lawsuit against the Company in an attempt to claim a large claim against the Company holding the patents when he has no billing records to pursue such actions against these companies
 24. Lastly, the negligent actions of Wheeler and Proskauer resulted in and were the proximate cause of loss to the Company; true copies of exhibits and witnesses are available on request and/or I will, on behalf of the Company, presented them



according to proof at commencement of investigation into this General Complaint.

It is of special interest to note that Mr. Wheeler is especially culpable in the malfeasances against the Company, in that although other Bar Actions are being filed against individual conspirators, that all malfeasances committed against the Company have stemmed from relationships cultivated by Mr. Wheeler for the Company.

Due to the highly sensitive nature of the patent and copyright materials, exhibits will be provided once formal protections have been established in regard to this complaint.

Very truly yours,

IVIEWIT HOLDINGS, INC.

A handwritten signature in cursive script, appearing to read "E.I. Bernstein".

- Electronic Signature

Eliot I Bernstein
Iviewit Holdings, Inc.
10158 Stonehenge Circle
Boynton Beach, FL 33437
561.364.4240

And

A handwritten signature in cursive script, appearing to read "P. Stephen Lamont".

Electronic Signature for P. Stephen Lamont by Eliot I. Bernstein his attorney -in-fact
P. Stephen Lamont
CEO
Iviewit Holdings, Inc.



Part 3 – Florida Bar Complaint Witness List

**Michele Mulrooney, Esquire
Armstrong Hirsch Jackoway Tyerman & Wertheimer, P.C.
1888 Century Park East
Suite 1888
Los Angeles, California 90067-1702
Business: (310) 553-0305**

Has information pertaining to allegations that Mr. Wheeler; provided false information regarding the background of Mr. Utley to induce company to hire him; disseminated business plans with Kenneth Rubenstein as an advisor to Board, disseminated business plans with false information regarding MR. Utley, information regarding filing of patents without information disclosed by Company, information regarding patents written into Mr. Brian Utley's name as sole inventor and sent to home address without assignment to the Company, information regarding threats on inventor Eliot Bernstein's life leading to his moving family for safety concerns, information regarding interference with Company clients Warner Brothers, information regarding Mr. Utley misrepresentations in potential client Paramount/Viacomm; information regarding interference with Company by Wheeler referral Crossbow Ventures and damages caused by such interference to client Warner Brothers, information regarding Kenneth Rubenstein refusal to talk with client Warner Brothers leading to client refusing to continue business operations, information regarding her firms refusal to continue business with Company based on Mr. Utley's being caught lying to her client introduction Paramount Pictures which led to firms unwillingness to introduce Company to further prospects including but not limited to; FOX, Vivendi, Sony and MGM.

Because of the events that were being uncovered Armstrong Hirsh felt that the Company posed risk to their reputation with clients they were introducing Company to and led to their firm withdrawing as counsel to the Company.

**Alan Epstein, Esquire
Armstrong Hirsch Jackoway Tyerman & Wertheimer, P.C.
1888 Century Park East
Suite 1888
Los Angeles, California 90067-1702
Business: (310) 553-0305**

As an Advisory Board member to the Company has information pertaining to allegations that Mr. Wheeler; provided false information regarding the background of Mr. Utley to induce company to hire him; disseminated business plans with Kenneth Rubenstein as an advisor to Board, disseminated business plans with false information regarding MR. Utley, information regarding filing of patents without information disclosed by Company, information regarding patents written into Mr. Brian Utley's name as sole inventor and sent to home address without assignment to the Company, information regarding threats on inventor Eliot Bernstein's life leading to his moving family for safety concerns, information regarding interference with Company clients Warner Brothers, information regarding Mr. Utley misrepresentations in potential client Paramount/Viacomm; information regarding interference with Company by Wheeler referral Crossbow Ventures and damages caused by such interference to client Warner Brothers, information regarding Kenneth Rubenstein refusal to talk with client Warner Brothers leading to client refusing to continue business operations, information regarding their firms refusal to continue business with Company based on Mr. Utley's being caught lying to client introduction Paramount Pictures which led to firms unwillingness to introduce Company to further prospects including but not limited to; FOX, Vivendi, Sony and MGM.

Because of the events that were being uncovered Armstrong Hirsh felt that the Company posed risk to their reputation with clients they were introducing Company to and led to their firm withdrawing as counsel to the Company.



Mitchell Welsch
UBS/Paine Webber Inc.
5 Radnor Corporate Center
100 Matsonford Road
Suite 444
Radnor, PA 19087
(800) 942-0409 ext7251

Has information pertaining to allegations that Mr. Wheeler; provided false information regarding the background of Mr. Utley to induce company to hire him; disseminated business plans with Kenneth Rubenstein as an advisor to Board, disseminated business plans with false information regarding MR. Utley, information regarding filing of patents without information disclosed by Company, information regarding patents written into Mr. Brian Utley's name as sole inventor and sent to home address without assignment to the Company, information regarding threats on inventor Eliot Bernstein's life leading to his moving family for safety concerns, information regarding interference with Company clients Warner Brothers.

James Armstrong
126 Buttonwood Drive
Fair Haven, NJ. 07704
(732) 747-1448

Has information pertaining to allegations that Mr. Wheeler; provided false information regarding the background of Mr. Utley to induce company to hire him; disseminated business plans with Kenneth Rubenstein as an advisor to Board, disseminated business plans with false information regarding MR. Utley, information regarding filing of patents without information disclosed by Company, information regarding patents written into Mr. Brian Utley's name as sole inventor and sent to home address without assignment to the Company, information regarding threats on inventor Eliot Bernstein's life leading to his moving family for safety concerns. Has information regarding Mr. Wheeler being involved in patent malfeasances regarding missing and wrong information in the patents filed on behalf of the Company. Has information in which Mr. Wheeler attended meetings with representatives of Foley and Lardner regarding false and missing information contained in the patents filed on behalf of the Company.

Tom Coester, Esquire
Blakely, Sokoloff, Taylor & Zafman, LLP
12400 Wilshire Blvd.
Seventh Floor
Los Angeles, CA 90025-1030
(310) 207-3800

Uncovered information that Mr. Utley had patents being written into his own name through attorney referrals by Mr. Wheeler and his executive referral Mr. utley with a one Mr. William Dick of Foley and Lardner. Has knowledge that such fraudulent patents were submitted via US Postal service to US Patent and Trademark Office and his firm had to correct such fraudulent patents

Norman Zafman, Esquire
Blakely, Sokoloff, Taylor & Zafman, LLP
12400 Wilshire Blvd.
Seventh Floor
Los Angeles, CA 90025-1030
(310) 207-3800



Uncovered information that Mr. Utley had patents being written into his own name through attorney referrals by Mr. Wheeler and his executive referral Mr. utley with a one Mr. William Dick of Foley and Lardner. Has knowledge that such fraudulent patents were submitted via US Postal service to US Patent and Trademark Office and his firm had to correct such fraudulent patents

Simon Bernstein
7020 Lions Head Lane
Boca Raton, FL 33496
(561) 988-8984

Information pertaining to all allegations as the ex Chairman of the Board

Guy Iantoni
Strategica Technologies, Inc.
1167 Oxford Court
Highland Park, IL 60035
(847) 432-0873

Information pertaining to all allegations

Jeffrey Friedstein
Goldman Sachs Group, Inc.
4900 Sears Tower
Chicago, IL 60606
2142 Churchill Lane
Highland Park IL 60035
(800) 233-9622

Information pertaining to all allegations

David Colter
Vulcan Ventures
(425) 453-1940
david.colter@attbi.com

Has information regarding the conflict of interest between Proskauer Rose and I View It that led to AOLTW/WB ceasing to do business with Iviewit. Has information regarding threats by MR. utley on Mr. Bernstein. Has knowledge of patent malfeasances resulting from Mr. Wheeler and Mr. Rubenstein's work on behalf of Proskauer Rose. Has knowledge of AOLTW/WB infringement of Iviewit Intellectual properties. Disseminated business plans with Kenneth Rubenstein as an advisor to Board, disseminated business plans with false information regarding MR. Utley, information regarding filing of patents without information disclosed by Company, information regarding patents written into Mr. Brian Utley's name as sole inventor and sent to home address without assignment to the Company, information regarding threats on inventor Eliot Bernstein's life leading to his moving family for safety concerns, information regarding interference with Company clients Warner Brothers, information regarding Mr. Utley misrepresentations in potential client Paramount/Viacomm; information regarding interference with Company by Wheeler referral Crossbow Ventures and damages caused by such interference to client Warner Brothers, information regarding Kenneth Rubenstein refusal to talk with client Warner Brothers leading to client refusing to continue business operations, information regarding her firms refusal to continue business with Company based on Mr. Utley's being caught lying at Paramount Pictures.

P. Stephen Lamont
I View It Technologies, Inc.



4 Ward Street
Brewster, NY 10509
(845) 279-7710

As acting CEO of Iviewit has information pertaining to all allegations in the complaint

Donald G. Kane II
GDI
540 Dalewood Lane
Hinsdale, IL 60521
540 Dalewood Lane
Hinsdale, IL 60521
(630) 325-5622

As a Board member to Iviewit has information pertaining to most allegations contained in the complaint. Has information regarding Iviewit securities being transferred by Mr. Wheeler and Mr. Utley without Board approval and without proper documentation.

Zakirul Shirajee
9485 Boca Cove Circle
Apt. #708
Boca Raton, FL 33428
(561) 488-4351

Has information regarding inventors being left off patents as he is one of the original inventors

Jennifer Kluge
3100 N.E. 49th St.
Apt.#905
Ft. Lauderdale, FL 33308
or
361 North East 43rd Court
Oakland Park, Florida 33334
Home 2: (954) 772-6444

Has information pertaining to threats against Mr. Bernstein which forced him to take his family and leave FL for their safety.

Jude Rosario
5580 NW 61 Street
Apt. 625
Coconut Creek, FL 33073
(561) 451-4900 ext 413
(954) 574-9338

Has information regarding inventors being left off patents as he is one of the original inventors

Jack Scanlan
1560 Yosemite Drive,
Suite 129,
Los Angeles, CA 90041
(323) 258-1742

Has information regarding patent malfeasances that led to AOLTW/WB ceasing business with Iviewit, amongst other clients that were affected including but not limited to Paramount Pictures and Sony Pictures.



Kenneth Anderson
MyCFO.com
2029 Century Park East
Suite 800
Los Angeles, California 90067
(310) 407-1170

As a Board member to Iviewit has information pertaining to most allegations contained in the complaint. Has information regarding Iviewit securities being transferred by Mr. Wheeler and Mr. Utley without Board approval and without proper documentation.

Wayne Smith, Esq
4000 Warner Blvd.
Burbank, CA
United States of America

Has information regarding the conflict of interest between Proskauer Rose and I View It that led to AOLTW/WB ceasing to do business with Iviewit

Steven Selz, Esquire
Selz & Muvdi
(561) 820-9409

Has information pertaining to all allegations alleged. Is currently counsel for I view It in frivolous lawsuit filed by Mr. Wheeler on behalf of Proskauer Rose in Judge Jorge LaBarga's court.

Monte Friedkin
(954) 972-3222 x310
Benada Aluminum of Florida
1911 NW 32nd Street
Pompano Beach, FL 33064

Has information regarding Mr. Utley's false resume submitted by Mr. Wheeler. Has information that Mr. Wheeler had knowledge of both Mr. Utley and Mr. Bill Dick's patent malfeasances against a company, Diamond Turf, that he had to close due to the malfeasances caused by these patent issues.

Candice Bernstein
10158 Stonehenge Circle
Suite 801
Boynton Beach, FL 33437-3546
561.364.4240

Information pertaining to all allegations

Caroline Prochotska Rogers, Esquire
1949 Cornell Avenue
Melrose Park, IL 60160
Business Phone:
(708) 450-9400 ext 19

Hired to investigate claims against Christopher Wheeler in response to all allegations. Has information regarding Mr. Wheeler's; failure to take reasonable steps to ensure that the intellectual property of the Company was protected; and, failure to and/or inadequately completed work regarding patents, copyrights and trademarks; and, engaged in unnecessary and duplicate corporate



and other work; and, by redacting information from the billing statements regarding services provided so to as to give the appearance that the services provided by Proskauer were limited in nature, when in fact they involved various aspects of intellectual property protection; and, by knowingly and willfully representing and agreeing to accept representation of clients in conflict with the interests of the Company, without either consent or waiver by the Company. Has information pertaining to Mr. Utley and the misrepresentation of his character and past employment. Has information regarding Mr. Utley and Mr. Dick being involved in prior patent malfeasances.



Exhibit "A"



PROSKAUER ROSE LLP

2255 Glades Road
Suite 340 West
Boca Raton, FL 33431-7360
Telephone 561.241.7400
Elsewhere in Florida
800.432.7746
Fax 561.241.7145

NEW YORK
LOS ANGELES
WASHINGTON
NEWARK
PARIS

Christopher C. Wheeler
Member of the Firm
Direct Dial 561.995.4702

September 8, 1999

Mr. Brian G. Utley
iviewit LLC
c/o Goldstein Lewin
1900 Corporate Boulevard, Suite 300-E
Boca Raton, FL 33431

Re: Engagement Agreement for iviewit LLC

Dear Brian:

Thank you for the opportunity to represent iviewit LLC in connection with general corporate advice (the "Work") and such other matters as we may undertake on your behalf from time to time. As is our Firm's custom, we are writing to confirm our agreement regarding such representation.

Our fees for services performed will be billed at our regular hourly rates. Currently, these rates range from \$135.00 to \$385.00 per hour for all legal services performed by the Firm's attorneys in our Boca Raton office. The hourly rate charged by any particular attorney within the range mentioned depends on such factors as that lawyer's experience, familiarity with the subject matter being worked upon, and such other factors as have been determined by the Firm in establishing the normal hourly rates for its attorneys. Time spent by any legal assistant is currently charged at \$90.00 per hour.

In addition to the fees described above, you agree to reimburse and pay us for all disbursements made by us, and our customary charges for in-house services in connection with the legal services performed under this agreement, including document reproduction and facsimile charges, computerized legal research, overtime (if required), travel expenses, court filing fees, postage, messenger and overnight courier fees, long-distance telephone charges, document preparation charges, word processing, taxes and miscellaneous expenses.

We anticipate billing you on a monthly basis, with payment of all monies due within 30 days of receipt. We will send you periodic statements setting forth the amount of the fees, disbursements and charges to which we are entitled and the basis for their calculation. Although, as noted above, we will ordinarily bill you monthly for fees, disbursements and charges of the preceding

0894/40017-001 BRLIB1/240799 v1

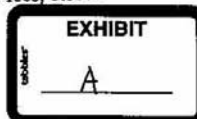

09/08/99 02:56 PM (2743)



PROSKAUER ROSE LLP

Mr. Brian G. Utley
September 8, 1999
Page 2

month, we may occasionally defer billing for a given month (or months) if the accrued fees and costs do not warrant current billing or if other circumstances would make it more convenient to defer billing.

We are waiving a retainer at this time, but we reserve the right to ask for one at any time.

You have the right to discharge us as your counsel in connection with the Work at any time, but such discharge shall not affect our right to be paid all our previously incurred but unpaid fees, and all our previously incurred but unpaid charges and disbursements, in accordance with this letter agreement.

We may from time to time, either at your request or at our own initiative, provide you with an estimate of fees or costs that we reasonably anticipate will be incurred in connection with the Work. It is understood that such estimates, which are predicated on a variety of assumptions, are subject to unforeseen circumstances and are by their nature inexact.

If you agree that the foregoing meets with your approval, please sign and return to me the enclosed copy of this letter as soon as possible.

We very much appreciate the opportunity to represent you in this matter.

Best regards.

Cordially,

Christopher C. Wheeler

0894/40017-001 BRLIB1/240799 v1

09/08/99 02:56 PM (274)

PROSKAUER ROSE LLP

2255 Glades Road
Suite 340 West
Boca Raton, FL 33431-7360
Telephone 561.241.7400
Elsewhere in Florida
800.432.7746
Fax 561.241.7145

NEW YORK
LOS ANGELES
WASHINGTON
NEWARK
PARIS

Matthew Triggs
Member of the Firm

Direct Dial 561.995.4743
mtriggs@proskauer.com

April 7, 2003

Via Hand Delivery

Lorraine Christine Hoffman, Esq.
Assistant Staff Counsel
The Florida Bar
Cypress Financial Center, Suite 835
5900 North Andrews Avenue
Fort Lauderdale, Florida 33309

Re.: Complaint of Eliot Bernstein against Christopher Wheeler, Esq.
The Florida Bar File No. 2003-51, 109 (15C)

Dear Ms. Hoffman:

This letter is in response to your March 7, 2003 letter to Christopher Wheeler and the accompanying bar complaint filed by Eliot Bernstein. As you would expect, Mr. Wheeler and Proskauer take this matter very seriously. Obviously, if you need any further information or documentation, we welcome the opportunity to assist in that regard.

Before addressing the specific allegations contained in the bar complaint, we believe that it is important to provide you with the factual background that gave rise to Mr. Bernstein's allegations. The complaint relates to an attorney-client relationship between Proskauer and several corporations bearing the name "Iviewit," of which Mr. Bernstein was a principal. Mr. Wheeler and numerous other Proskauer attorneys represented Iviewit as general corporate counsel from approximately December 1998 through May 2001, when Proskauer withdrew from its representation due to Iviewit's nonpayment of Proskauer's legal bills. During this two and a half year relationship, approximately twenty Proskauer attorneys in two of its national offices, including Mr. Wheeler, performed a vast array of corporate, securities, restructuring, and refinancing work for the Iviewit entities.

Iviewit fell victim to the same plague that affected many "dot.com" companies during this time period -- a lack of funding. As a result, Iviewit suffered financial problems, and amounts owed to Proskauer continued to grow. Ultimately, Iviewit owed Proskauer a total of almost \$370,000 for legal services by the time Proskauer ceased to represent it. When Iviewit was unable to arrive at a

PROSKAUER ROSE LLP

Lorraine Christine Hoffman, Esq.
Assistant Staff Counsel
April 7, 2003
Page 2

satisfactory payment arrangement, Proskauer filed a lawsuit in May 2001 in Palm Beach County Circuit Court (the "Litigation") seeking to collect its attorneys' fees. The action is entitled *Proskauer Rose LLP v. Iviewit.com, Inc. et al.*, Case No. CA 01-04671 AB (the "Litigation"), and is currently set for trial before the Honorable Jorge Labarga on May 28-29, 2003. A copy of the Amended Complaint filed in the Litigation is attached hereto as **Exhibit 1**.

On January 28, 2003, after the Litigation had been pending for over 21 months, Iviewit sought leave to assert what it contended was a **\$10 billion** counterclaim, raising allegations similar to those contained in Mr. Bernstein's bar complaint. A copy of the proposed counterclaim is attached hereto as **Exhibit 2**. The Court denied Iviewit's motion for leave to amend by order dated February 4, 2003, a copy of which is attached as **Exhibit 3**. Mr. Bernstein's bar complaint followed on the heels of that denial.

Although the bar complaint purports to be sworn to under penalty of perjury by Mr. Bernstein, Mr. Bernstein's deposition was taken recently in the Litigation. At that time, Mr. Bernstein offered sworn testimony of what he described as a conspiracy to steal his technology, which, according to Mr. Bernstein, was set in motion by Mr. Wheeler, along with such alleged co-conspirators as Mr. Rubenstein, Iviewit's former President (Brian Utley), special counsel at the nationally known law firm of Foley & Lardner (William Dick), and another lawyer previously employed by the law firm Meltzer, Lippe, Goldstein & Schlissel, LLP (Raymond Joao).¹ According to Mr. Bernstein's sworn testimony, this plot -- all the members of which Mr. Bernstein was never able to consistently identify -- involves an alleged death threat made by Iviewit's former President and Chief Operating Officer, which, as Mr. Bernstein testified, has caused him to fear for his life and, as we will show below, has caused Mr. Bernstein to believe that Proskauer is "evil."

Obviously, there was no murder plot, no conspiracy, and no attempt on the part of anyone to injure Mr. Bernstein or his business. We point this out only to highlight the rather extreme and unfounded nature of the accusations leveled against a whole host of attorneys, at several law firms throughout the United States. We respectfully suggest that, viewed in context, the bar complaint is simply an ill-advised litigation tactic that is utterly devoid of any factual or legal support.

I. The Issues Raised in the Bar Complaint

As far as we can discern from Mr. Bernstein's bar complaint, he appears to raise four main issues. They are summarized below, and our response is noted.

A. **Patent Work:** Mr. Bernstein alleges that Proskauer mishandled certain patent work. To the contrary, as we show below (see Section III), there is overwhelming testimonial and documentary evidence showing that **Proskauer simply never performed patent work for Iviewit.**

¹ Mr. Bernstein also filed similar complaints with the New York Departmental Disciplinary Committee against Messrs. Joao and Rubenstein. Those complaints are currently pending.

PROSKAUER ROSE LLP

Lorraine Christine Hoffman, Esq.
Assistant Staff Counsel
April 7, 2003
Page 3

Iviewit's patent work was handled entirely by other law firms. Whether there were any errors or omissions with the patent work is immaterial. Proskauer simply did not perform that work.

B. Misrepresentations: Mr. Bernstein alleges that Mr. Wheeler misrepresented: (i) Brian Utley's background while recommending him for a position with Iviewit; (ii) patent attorney William Dick's background; (iii) that Raymond Joao was a Proskauer attorney; and (iii) that Kenneth Rubenstein was a Proskauer partner when he was not. As will be shown below (see Section IV), none of these accusations have any merit.

C. Conflicts of Interest: Mr. Bernstein alleges that Proskauer: (i) represented other clients with a conflict of interest to Iviewit; (ii) failed to disclose the prior representation of Brian Utley; and (iii) somehow improperly accepted Iviewit stock during the course of performing services for it. The reality is there was no conflict in Proskauer's representation of Iviewit, and while the Proskauer firm accepted shares of stock that were offered by Iviewit, we are aware of no ethical prohibition to accepting stock under such circumstances. (see Section V, below).

D. General Work: Mr. Bernstein alleges that Proskauer: (i) engaged in unnecessary and duplicative work; (ii) redacted information from billing statements; and (iii) lacked competence, diligence, and failed to communicate with Iviewit. Quite to the contrary, the deposition testimony and documentary evidence prove that Proskauer's representation of Iviewit was in full compliance with all ethical standards and otherwise of the quality to be expected of a national law firm. (see Section VI, below).

II. Proskauer's Representation of the Iviewit Companies

The work performed by Proskauer for Iviewit for over two and a half years was quite substantial, as it involved over twenty Proskauer lawyers in two of its national offices. Eliot Bernstein and his father, Simon Bernstein, initially approached Mr. Wheeler in late 1998 to secure Proskauer's services in forming corporations to manage, market, and facilitate the sale of a form of computer imaging technology. During the two and a half years when Proskauer represented the Iviewit companies, Proskauer acted as general corporate counsel and was responsible for, among many things, corporate formation, securities work, restructuring, and refinancing. Indeed, Proskauer's files for its representation over two and a half years fill 17 cartons. The work was complex and vast, and Proskauer's statements attached hereto as **Exhibit 4** paint a clear picture of the type of demands made by Iviewit – all of which were carried out to the satisfaction of Iviewit's principals, including Mr. Bernstein.

Not only is there no documentary evidence to support the allegations made by Mr. Bernstein in the bar complaint, Mr. Bernstein's claims are squarely contradicted by the testimony of former principals of Iviewit, several of whom ran the day-to-day operations of the Iviewit entities. Brian Utley, Iviewit's former President and COO, Raymond Hersh, Iviewit's former CFO, and Gerald Lewin, CPA, a former member of the board of directors, have all testified in depositions in the Litigation that

PROSKAUER ROSE LLP

Lorraine Christine Hoffman, Esq.
Assistant Staff Counsel
April 7, 2003
Page 4

they were satisfied with Proskauer's services, and that Iviewit did not pay the bills subject to the pending Litigation because of Iviewit's financial problems.

III. Proskauer Did Not Perform Patent Work For Iviewit

Mr. Bernstein's bar complaint is replete with allegations concerning alleged improper patent work. Both Proskauer attorneys and corporate representatives of Iviewit have confirmed under oath that there is no truth to any of these assertions. Rather, Iviewit's patent work was performed by Raymond Joao, who at the time was employed by Meltzer Lippe, and thereafter by William Dick of Foley & Lardner. This is confirmed by the depositions taken during the course of the Litigation, including that of Iviewit's former President and COO, Brian Utley, who testified that "Rubenstein and Mr. Wheeler, I'll repeat, had nothing to do with the patents. . . ." (Deposition of Brian Utley ("Utley Dep.") at 150-9).

When asked to opine as to the veracity of an interrogatory answer submitted by Mr. Bernstein during the course of the Litigation which suggested that Proskauer played a role with respect to Iviewit's patent work, Mr. Utley was unequivocal in his response:

Q. The answer to [Eliot Bernstein's] Interrogatory 20 in Subparagraph Roman Numeral XI, 11, it says: "Chris Wheeler agreed to investigate charges that Rubenstein and the name J-O-A-O, which I think is Joao. . . . [w]ere forging and changing patent documents and leaving inventors off patents. Wheeler and Utley suggest using their friend William D-I-C-K, and then it looks like it's cut off, Foley & Lardner to correct the gross negligence uncovered in Rubenstein/Joao work."

How do you respond to that statement?

A. Well, Rubenstein was never involved in any of that work.

Q. Is that a misrepresentation?

A. That's a misrepresentation.

Q. Were there any charges by you or anyone at Iviewit that Joao was forging and changing patent documents and leaving inventors off patents?

A. No.

Id. at 83-15.

Gerald Lewin, a certified public accountant and principal of the CPA firm of Goldstein, Lewin & Company in Boca Raton testified similarly. He testified that he was initially approached by Eliot Bernstein's father, Simon Bernstein, who is also Mr. Lewin's neighbor, and asked to be a consultant for the Iviewit entities. (Deposition of Gerald Lewin ("Lewin dep.") at 7-14). Mr. Lewin agreed and ultimately became a member of Iviewit's board of directors. *Id.* at 9-1. Mr. Lewin introduced Eliot

PROSKAUER ROSE LLP

Lorraine Christine Hoffman, Esq.
Assistant Staff Counsel
April 7, 2003
Page 5

and Simon Bernstein to Mr. Wheeler at Proskauer, after the Bernstein's asked Mr. Lewin for a referral to a national law firm to represent the Iviewit entities. *Id.* at 8-3.

Like Mr. Utley, Mr. Lewin testified that Proskauer did not perform patent work for Iviewit and that the patent work was handled by other law firms. *Id.* at 10-25; 17-16; 50-8. Mr. Lewin also testified that, as a member of the board of directors, he never heard anyone complain that Proskauer did work improperly for Iviewit (*Id.* at 15-3), that he was never aware of any problems with Proskauer's bills (*Id.* at 19-19), and that the only reason why Proskauer's bills were not paid was because Iviewit had financial problems. *Id.* at 14-17.

Kenneth Rubenstein, who was also deposed in connection with the Litigation, could not have been clearer as to the scope of Proskauer's representation:

- Q. Did you ever opine with regard to the validity of any patent applied for or received by Iviewit.com?
- A. Like I say, I was not in any way involved with getting patents for Iviewit.
- Q. What were you involved with, if you were, with Iviewit?
- A. The only thing I did for Iviewit is I referred them to another patent lawyer.
- Q. And who is that?
- A. A guy named Ray Joao.
- Q. And where did Mr. Joao work?
- A. I believe he was working at the time at my former law firm, Meltzer Lippe.

(Deposition of Kenneth Rubenstein ("Rubenstein dep.") at 23-4).

Finally, it should be noted that Proskauer's invoices also confirm that Proskauer did not perform patent work. Rather, Proskauer's role was limited to referring the patent work to other law firms. Thus, regardless of whether Mr. Bernstein is pleased or displeased with the patent-related services provided to Iviewit, Proskauer simply did not provide those services. In short, Mr. Bernstein's accusations that Proskauer somehow performed patent work at all, much less performed patent work improperly, is demonstrably false.

IV. No Misrepresentations Were Made To Eliot Bernstein

In his complaint, Mr. Bernstein alleges that Mr. Wheeler somehow misrepresented the credentials of several people to Iviewit, most notably Brian Utley, Iviewit's former President and COO. According to Mr. Bernstein, Mr. Wheeler misrepresented the background of Mr. Utley in order to induce Iviewit to hire him.

PROSKAUER ROSE LLP

Lorraine Christine Hoffman, Esq.
Assistant Staff Counsel
April 7, 2003
Page 6

It is worth noting that, at the time of his hiring as the President of Iviewit, Mr. Utley was retired from a **thirty-seven year career with IBM**, serving as the Vice-President and General Manager in charge of the Boca Raton, Florida operations. Contrary to Mr. Bernstein's allegations, Mr. Wheeler merely introduced Mr. Utley to Simon Bernstein and advised him that he first met Mr. Utley in 1990 on a social level and subsequently served with him on the Florida Philharmonic and Florida Atlantic University Foundation Boards. (Deposition of Christopher Wheeler ("Wheeler dep.") at 113-18, 131-20). The introduction was made because Simon Bernstein was looking for someone to run Iviewit and asked Mr. Wheeler for a recommendation. Mr. Wheeler disclosed his social relationship with Mr. Utley to Simon Bernstein and told him that Mr. Utley was the site manager of IBM's Boca Raton office when they first met in 1990. *Id.* at 115-12, 117-1. Mr. Wheeler advised Mr. Bernstein to explore with Mr. Utley whether he was a good fit for Iviewit. *Id.* at 115-12. At no point did Mr. Wheeler submit any "false resumes" on behalf of Mr. Utley and he is unaware of the existence of any such document.

Mr. Bernstein also alleges that Mr. Wheeler misrepresented to Iviewit that Raymond Joao and Kenneth Rubenstein were associated with Proskauer Rose when, according to Mr. Bernstein, they were not. Yet again, there is no truth to Mr. Bernstein's claim. As for Mr. Joao, Mr. Wheeler never represented Mr. Joao as being a Proskauer attorney at any point. At that time, Mr. Joao was an attorney with Meltzer Lippe, and he was retained by Iviewit to perform patent work.

As for Mr. Rubenstein, he is a partner at Proskauer, resident in the firm's New York office. At no point did Mr. Wheeler misrepresent anything concerning him. To the contrary, Mr. Wheeler simply represented to Iviewit that Mr. Rubenstein was a partner of Proskauer. Mr. Rubenstein joined Proskauer in June 1998 as a partner. Proskauer did not begin to provide legal services to Iviewit until 1999. Thus, Mr. Rubenstein was a Proskauer partner at the time Proskauer first commenced work for Iviewit.

Mr. Bernstein raises similar allegations of misrepresentations concerning William Dick, special counsel to Foley & Lardner in that firm's Milwaukee office. Here again, there is no truth to Mr. Bernstein's claim that Mr. Wheeler misrepresented anything concerning Mr. Dick.

V. No Conflicts Of Interest Existed In Proskauer's Representation Of Iviewit

Mr. Bernstein also alleges the existence of a conflict of interest on the part of Mr. Wheeler based on his prior representation of Mr. Utley in other matters. At the time Mr. Wheeler introduced Mr. Utley to Mr. Bernstein, Mr. Wheeler disclosed that Proskauer had previously formed a corporation for Mr. Utley in approximately 1993. At the time the introduction was made, Mr. Utley was not a current client of the firm. In short, there was no conflict of interest arising out of Mr. Wheeler merely introducing Mr. Utley to Iviewit.

PROSKAUER ROSE LLP

Lorraine Christine Hoffman, Esq.
Assistant Staff Counsel
April 7, 2003
Page 7

Mr. Bernstein's bar complaint also makes vague accusations that Proskauer represented clients in conflict with Iviewit, failed to disclose such representations and/or secure conflict waivers from Iviewit, and improperly accepted company stock from Iviewit. These accusations are baseless.

As far as acceptance of stock is concerned, it was Mr. Bernstein who wanted to grant some shares of Iviewit stock to Proskauer. For Mr. Bernstein to now complain about this tells volumes as to his motivation and as to the credibility of his accusations. Indeed, Mr. Wheeler testified in his deposition in the litigation that Mr. Bernstein wanted to grant shares of Iviewit stock to Proskauer because Mr. Bernstein felt that "all members of his team should be stakeholders in his company." (Wheeler dep. at 62-24). Mr. Utley also testified that it was Mr. Bernstein's "personal decision" (Utley dep. at 241-9) to grant a small interest in Iviewit, LLC (a corporation that is no longer in business) to Proskauer "because of the quality of work that [Proskauer] had performed for the company over the prior six months." *Id.* at 238-19. Mr. Utley also confirmed that this grant of stock to Proskauer "had no bearing on the billings." *Id.* at 240-18. In sum, there is no ethical prohibition to Proskauer accepting this gift of stock from Mr. Bernstein.

The fact that Mr. Bernstein gave a gift to Proskauer of a small percentage of stock in Iviewit, if anything, provides further evidence to refute Mr. Bernstein's conspiracy theory. If Proskauer owned 2.5 percent of Iviewit, LLC, why would, as Mr. Bernstein alleges, Proskauer engage in a conspiracy to cause \$10 billion in damages to Iviewit? Such conduct would be directly adverse to Proskauer's economic interest by causing Proskauer to lose \$250 million. Simply put, Mr. Bernstein's allegations make no sense.

Mr. Wheeler similarly denies Mr. Bernstein's allegation that Proskauer represented clients in conflict with Iviewit without obtaining conflict waivers from Iviewit. It is telling that Mr. Bernstein chose not to identify any of the alleged clients of Proskauer with which a conflict existed, or otherwise identify what the conflict was. Although Mr. Bernstein alludes to some alleged conflict involving Warner Bros., there is no merit to any such claim. While it is true that Proskauer provides legal services to Warner Bros. in various contexts, none of them involve taking a position adverse to Iviewit and, in fact, none of them even related to Iviewit at all.

Aside from a brief review, at the request of Iviewit, of a draft form confidentiality agreement that Iviewit sent to Warner Bros., we performed no work for Iviewit that is in any way related to its dealings with Warner Bros. The confidentiality agreement reviewed by Proskauer was one of more than one hundred sixty such form confidentiality agreements obtained by Iviewit. Indeed, at the time the Warner Bros. confidentiality agreement was reviewed, Mr. Wheeler was unaware that Warner Bros. was a client and, to our knowledge, no lawyer in our Boca Raton office provided any legal services to Warner Bros.

Proskauer's only other involvement with Iviewit concerning Warner Bros. was at the urging of Mr. Utley, who suggested that Mr. Rubenstein call his contact at Warner Bros. to simply suggest that Warner Bros. talk to Iviewit. At a later date, Stephen Lamont, an Iviewit representative, sought to

PROSKAUER ROSE LLP

Lorraine Christine Hoffman, Esq.
Assistant Staff Counsel
April 7, 2003
Page 8

enlist Mr. Rubenstein's assistance by having him essentially vouch for Iviewit's product to Warner Bros. Mr. Rubenstein declined this request, citing Proskauer's existing relationship with Warner Bros.

VI. Proskauer Was Diligent and Competent in its Representation of Iviewit

Although Mr. Bernstein's complaint makes vague references to unsubstantiated allegations of lack of competence and diligence, the deposition testimony of Iviewit's corporate representatives confirms that Proskauer's work was thorough and of high quality.

Mr. Utley was the principal of Iviewit who dealt with Mr. Wheeler and Proskauer attorneys on a day-to-day basis (Utley dep. at 16-2) and who was responsible for directing Proskauer to perform legal work. *Id.* at 23-18. In response to pointed questions, Mr. Utley testified as follows:

Q. Do [you] feel that Proskauer ever committed a malpractice in its representation of Iviewit?

A. No.

Id. at 37-2.

Q. Did anyone ever complain or state at any board meetings of Iviewit that Proskauer performed poorly with respect to legal work?

A. No.

Id. at 66-6.

Mr. Utley was asked whether he was ever dissatisfied with Proskauer's representation of the Iviewit entities. He testified that his only complaints dealt with some "duplicative effort" on Proskauer's bills which were addressed by Mr. Wheeler and handled to Mr. Utley's satisfaction. *Id.* at 26-16. Mr. Utley also testified that he received and reviewed Proskauer's bills on a monthly basis (*Id.* at 31-10), that the bills were "reasonably accurate" (*Id.* at 29-22), that he "didn't find any problems with the bills" (*Id.* at 31-18), and that the bills are currently owed. *Id.* at 35-12. Utley also testified that the quality of Proskauer's work "was never an issue" at any Iviewit board meeting. *Id.* at 74-17.

Raymond T. Hersh was hired by Iviewit as a financial advisor to the Iviewit entities in April 2000 (Hersh dep. at 8-15), then later assumed the position of CFO in July 2000. *Id.* at 9-14. Mr. Hersh confirmed that it was he who "reviewed all bills that came in from all vendors and suppliers of services." *Id.* at 16-13. Mr. Hersh testified that Eliot and Simon Bernstein had made the initial decision to hire Proskauer. *Id.* at 12-14. Further, Mr. Hersh confirmed that the reason why Proskauer's bills were not paid by Iviewit was simply due to lack of funding. *Id.* at 14-15.

PROSKAUER ROSE LLP

Lorraine Christine Hoffman, Esq.
Assistant Staff Counsel
April 7, 2003
Page 9

Mr. Hersh, like Mr. Utley, also confirmed that Iviewit was satisfied with the services provided by Proskauer:

Q. Generally, were you satisfied with the services performed by Proskauer Rose?

A. Yes, I was.

Q. Do you know if Brian Utley was?

A. I know that he was.

Q. What about Ray – I'm sorry. What about [Simon] Bernstein or Eliot Bernstein?

A. I believe they were generally satisfied with the nature and quality of the work.

Q. Do you know if anyone from Iviewit ever complained to Proskauer about the substance of its representation of the Iviewit companies? And let me clarify by saying not – not the bills, but the actual work performed.

A. I understand. That's why I'm hesitating because I want to be able to respond to that distinction. I don't recall any of the principals of the company ever quarreling with the quality of the work.

Id. at 33-22.

Q. And there was never discussions at those board meetings that Proskauer shouldn't be paid or that there was a problem with Proskauer's bills as far as the substance of the work?

A. No, I never heard that.

Id. at 40-4.

Finally, Mr. Hersh, having been shown Iviewit's answer and affirmative defenses in the Litigation, characterized the affirmative defenses as "nonsense," a "[ruse]" (*Id.* at 44-17), and "not a true statement." *Id.* at 46-13.

Similarly, Gerald Lewin testified that he never heard anyone complain that Proskauer did work improperly for Iviewit (Lewin dep. at 15-3), that he was not aware of any problems with Proskauer's bills (*Id.* at 19-19), and that the only reason why Proskauer's bills were not paid was because Iviewit had financial problems. *Id.* at 14-17. Moreover, Mr. Lewin testified that he felt that Proskauer's bills were due and owing (*Id.* at 33-14), and that he was not aware of any objections by Iviewit to any of Proskauer's bills. *Id.* at 33-17.

Proskauer was not alone in being left unpaid by Iviewit. Hersh testified that all of the other law firms used by Iviewit were still owed money when he left the company in April 2001. Hersh depo. at 13-

PROSKAUER ROSE LLP

Lorraine Christine Hoffman, Esq.
Assistant Staff Counsel
April 7, 2003
Page 10

20. Mr. Lewin testified that "probably all the law firms" that did work for Iviewit stopped work due to nonpayment (Lewin dep. at 40-1), and that, as of the time of his deposition in September 2002, Iviewit had owed his accounting firm "[f]ifty some thousand dollars" for "[a]bout three years." *Id.* at 35-15. Finally, Utley testified that Foley & Lardner stopped doing work for Iviewit because of Iviewit's nonpayment of its bills. (Utley dep. at 22-4).

VII. Mr. Bernstein's Accusations Must Be Considered In Light Of His Recent Deposition Testimony

Mr. Bernstein's deposition testimony in the Litigation, taken just over a month ago, provides important context for consideration of his charges. Almost irrespective of the topic of questioning being pursued, Mr. Bernstein's testimony drifted into tales of murder, conspiracy, and theft involving several lawyers of national law firms and well respected businessmen and philanthropists:

* * *

A. . . . Well, my attorney Caroline has been working with people to protect me. Utley came out after being terminated, and they found patents had been written into his own name going to his house without assignment to the company, et cetera.

And [Utley] came out and basically told me that my life was in danger if I continued to pursue to be vocal about the fact that, you know, his background was clouded and that these patents were found -- well, that malfeasances were occurring is how I could basically couch that. And he said that him and Chris [Wheeler] would bring the company down brick by brick.

Q. Utley said this?

A. Yes.

Q. When was this?

A. This was around the end of 2000, in the January period.

Q. So you started learning about a conspiracy around that time?

A. Well, you know, the real -- you know, again, you ask about conspiracies. And you know, with hindsight, I could basically call it a conspiracy. But the real first conspiracies I learned of -- if you're asking for the whole conspiracy, is Ray Joao's work.

(Deposition of Eliot Bernstein ("Bernstein dep.") at 47-11).

As seen below, the alleged conspirators are numerous:

PROSKAUER ROSE LLP

Lorraine Christine Hoffman, Esq.
Assistant Staff Counsel
April 7, 2003
Page 11

- Q. You have no idea why Mr. [Hank] Powell was fired from Crossbow?
A. Perhaps for being involved in this conspiracy to steal my technologies.
Q. Mr. Powell was involved in the conspiracy?
A. I am not sure if Crossbow is involved, although they were referred to us by Chris Wheeler who spearheads the conspiracy. But, you know, you don't find these things out when there's a conspiracy until after the conspiracy is over.

Id. at 59-17.

- Q. -- was [Maurice] Buchsbaum involved in the conspiracy?
A. Buchsbaum is related to Chris Wheeler, so we're not sure yet 100 percent.

Id. at 60-10.

- Q. What did [Utley] tell you when he threatened your life?
A. He said: If you continue to expose these issues and pursue a course against me and Proskauer, we will kill you.
Q. Who is "we"?
A. Mean him, Chris Wheeler and Mike --
Q. Are you paraphrasing or are you quoting him?
A. I'm quoting him. And we will bring you down brick by brick by brick, your companies.
Q. He said: We will kill you --
A. Yes.
Q. -- and we will bring you down brick by brick?
A. Correct. So I called my wife and moved her into a hotel in California. She packed up overnight to move our children into a hotel. And we so lived in a hotel until we could get adequately --
Q. When was this?
A. We told everybody this.
Q. When was this?
A. This is right around January of 2001.

Id. at 93-14.

- Q. Did Mr. Utley threaten you in person or over the phone?
A. In person.
Q. Do you feel that he had the means to kill you?

PROSKAUER ROSE LLP

Lorraine Christine Hoffman, Esq.
Assistant Staff Counsel
April 7, 2003
Page 12

A. Well, he was touting Mr. Wheeler and Proskauer as being uncovered at this point for some of these malfeasances, like his background education.

Yeah.

Q. Do you feel that he had the means to kill you, is the question.

A. Yes. With those he was saying he's conspiring with absolutely.

Q. Who was he conspiring with to kill you?

A. Mr. Wheeler, Mr. Bill Dick of Foley & Lardner. These are some major law firms.

Q. So you felt at the time that if Mr. Utley was going to kill you, he was going to do it in conspiracy with Foley & Lardner and Proskauer Rose?

A. With members of those firms that he's good friends with.

* * *

Q. What other law firms were conspiring with Wheeler, Utley, and Proskauer?

A. Meltzer, Schnitzel & Gold (ph)--

Q. Meltzer Lippe --

A. Meltzer Lippe Schnitzel & -- I think Goldstein or something.

Id. at 98-10.

Q. Have you feared for your life because of this lawsuit?

A. You bet, every single day. I've hidden my children off the streets. I'm scared to death to leave my house. My wife is scared to death to leave the house.

* * *

Q. Do you think Proskauer Rose wants you dead?

A. Yes.

Q. Why?

A. Well, the technologies are valued to be worth billions; that, in itself, is a motive.

* * *

Q. Why did you come here today if you are afraid for your life?

A. I fear no evil.

* * *

PROSKAUER ROSE LLP

Lorraine Christine Hoffman, Esq.
Assistant Staff Counsel
April 7, 2003
Page 13

- Q. --in your mind you agreed to come here for your deposition today if this firm wants you dead.
A. I fear no evil. I fear no evil.
Q. Is Proskauer evil?
A. Yes. Because of these actions, yes.

Id. at 107-24.

- Q. Why do you come [to Proskauer's offices] and -- you have been here about three days now to review the files.
A. Yeah.
Q. Why do you come here and spend the day here when you fear for your life?
Why don't you just have Kinko's come and pick the files up and copy them for you?
A. I fear no evil, A, okay; I expressed that on the record before.

* * *

You know, if I died tomorrow from a hiccup, perhaps, everybody would look back here.

- Q. At Proskauer?
A. Absolutely.
Q. And think that --
A. Chris Wheeler.
Q. -- that they orchestrated an accidental death?
A. Correct. Or something, or purposely done.

Id. at 125-14.

- Q. Do you think your lawyer fears for his life?
A. I asked him that the other day.
Q. What did he say?
A. He said he fears nobody. He doesn't care that you are big. He doesn't care how big you are, he is not afraid of you.
Q. Do you think he is?
A. Yeah.
Q. You think he's in fear for his life because of this lawsuit?
A. Yes. I think it has run across his mind that he is sitting on a can of worms that could lead to the destruction of three large law firms.

PROSKAUER ROSE LLP

Lorraine Christine Hoffman, Esq.
Assistant Staff Counsel
April 7, 2003
Page 14

Id. at 117-1.

Q. Why did you move back to close proximity of Proskauer Rose, if you are in fear for your life of Proskauer?

A. I study the art of war, so deception and distance are often key tactics to warfare.

Somebody made a threat on me in their home ground, so I left their home ground to a ground where I have many legal friends. People to help me protect myself.

Q. Here?

A. No, California. I don't know shit here.

So -- and that's why I'm scared here. And I was scared for collateral damage to people like my parents, and whatnot, so I broke ties with them, hardly talked to them over the last year and a half, didn't let them see their grandchildren, never flew back here, okay.

Now I am prepared to wage war and have my evidence and guns in lie, I have no fear of --

Q. When you say "guns," are you speaking metaphorically?

A. Yes, of course.

Q. Okay.

A. And so, it's best to be here so that I can present my case, and I am not worried about you anymore killing me too much.

Q. Proskauer?

A. Proskauer, because now I think you've realized that there's a lot of people behind it that you didn't see coming, or you weren't paying attention and suddenly you've got a case.

Id. at 118-19.

As can be seen, the "truth" regarding the Litigation and the claims asserted by Mr. Bernstein's bar complaint proved to be a fluid concept in his deposition. As the deposition demonstrates, a person is either supporting Mr. Bernstein fully and unconditionally or is part of a conspiracy to destroy him. Mr. Bernstein's response to questions concerning Mr. Lewin and his possible involvement in a conspiracy is telling in this regard:

Q. Was [Gerald] Lewin part of the conspiracy?

A. Gerri just referred me to Chris [Wheeler].

PROSKAUER ROSE LLP

Lorraine Christine Hoffman, Esq.
Assistant Staff Counsel
April 7, 2003
Page 15

* * *

Q. [w]ere you on the telephone during Gerri Lewin's deposition?

A. No.

Q. He testified in his deposition that the only reason the bills weren't paid was because there wasn't any money?

A. **Well, then, we might have a problem with him being involved in the conspiracy.**

Id. at 186-25.

Mr. Bernstein's deposition testimony concerning his claim of "destruction" of documents is equally telling. Without a shred of evidence, Mr. Bernstein was willing to swear to the "destruction" of documents simply because he had not seen them:

Q. Did you ever see with your eyes anyone at Proskauer destroying any documents pertaining to Iviewit?

A. No.

Q. Did anyone ever tell you that they saw anyone at Proskauer destroying documents relating to Iviewit?

A. No.

Id. at 169-13.

Q. So you are still sticking to your story that Proskauer destroyed documents --

A. In my interpretation --

Q. -- but you have no personal knowledge of whether they did?

A. -- of the word destruction, because they are not present in any records that the company can now get, yes, they have been, since Mr. Wheeler was keeping records of them.

Q. So destroyed means missing to you?

A. Yes.

Id. at 238-6.

VIII. Conclusion

In order to assist you in your review of this matter, we have endeavored to provide you with specific references to deposition testimony and documents which refute Mr. Bernstein's assertions. In the process, we hope we have answered any questions you may have concerning Proskauer's representation of Iviewit. Mr. Bernstein's accusations are simply unfounded and scandalous. As can

PROSKAUER ROSE LLP

Lorraine Christine Hoffman, Esq.
Assistant Staff Counsel
April 7, 2003
Page 16

be seen, Iviviewit's own officers and directors have given sworn testimony refuting each and every assertion made by Mr. Bernstein. Our files are open and available for your review should you have any questions concerning this matter or need any additional information or documentation.

We thank you for giving us the opportunity to be heard.

Very truly yours,

A handwritten signature in black ink that reads "M. Triggs" with a date "4/7/03" written below it.

Matthew Triggs

Encl.

cc: Mr. Eliot I. Bernstein (with enclosures)



IVIEWIT HOLDINGS, INC.

P. Stephen Lamont
Chief Executive Officer
Direct Dial: 914-217-0038

April 30, 2003

By Hand Delivery

Lorraine Christine Hoffman, Esq.
Assistant Staff Counsel
The Florida Bar
Cypress Financial Center, Suite 835
5900 North Andrews Avenue
Fort Lauderdale, Fla. 33309

Re: **Rebuttal of Christopher C. Wheeler, Esq. Response to Complaint of Iviewit Holdings, Inc., The Florida Bar File No. 2003-51,109 (15C)**

Dear Ms. Hoffman:

By way of introduction, I am Chief Executive Officer (Acting) of Iviewit Holdings, Inc. and its subsidiaries (collectively, "Company") with a background of which the Company invites you to view at <http://www.iviewit.com/management.htm>, and I write to rebut all those material contradictions and feints in the response of Christopher C. Wheeler, Esq. ("Respondent") to the Company's Florida Bar Complaint of February 25 ("Complaint").

Moreover, and as Respondent has chosen to apprise you, the Company and Respondent's employer, Proskauer Rose LLP ("Proskauer"), are parties to that certain litigation titled Proskauer Rose LLP v. Iviewit.com, Inc. et. al., Case No. CA 01-04671 AB (Circuit Court of the 15th Judicial Circuit in and for Palm Beach County, Florida filed May 2, 2001) ("Litigation"), that, as Respondent is aware, yet prefaces and feints in more than a seven hundred word introduction, bears not one scintilla of relevance to the specific allegations contained in the Company's Complaint.

Furthermore, one more important feint to correct, wherein Respondent rolls to the right yet hopes that your Office looks to the left, is that the Company is not now nor has ever been a so called "dotcom" company, but rather is a designer and developer of video scaling and imaging technologies where, in combination and among other things, said technologies have the capability of "panning and zooming" on any image or any image



Lorraine Christine Hoffman, Esq.
4/30/2003
Page 2

within a video without degradation to the quality of that image (where degradation is termed “pixelation” to those skilled in the art).

Additionally, the Company technologies are targeted to device original equipment manufacturers (“OEMs”) who, when individually, or in combination with other third party hardware, firmware, and/or software, shall include them in OEM products such as, but not limited to, cable set top boxes, satellite set top boxes, analog-to-digital converter boxes, next generation DVD players, digital cameras, personal video recorders, and personal computers; alternatively the Company has the option of exclusively contributing said essential technologies to the multimedia patent pools known as MPEG 2 (digital compression according the digital television standard), MPEG 4 (another compression standard at a lower bit rate, and wherein interactive objects may be embedded), and DVD (“digital video disc”) player-drive-codec and the discs themselves. Quite all encompassing, one might say, and this is the important point to realize when viewing the material below.

Still further, from the benefit of the narrative and attached exhibits below, the Company shall prove beyond a reasonable doubt that Respondent, though not directly possessing of any patent experience and certainly not prosecuting patents himself, otherwise oversaw, directed, controlled, feloniously opined, sometimes impeded, altogether unfavorably aided and abetted, and otherwise positioned himself between said patent prosecutions, his other clients, many of which utilize the Company’s inventions in material breach of the Confidentiality Agreements fashioned by Respondent, and the inventors all to the detriment of the patent filings and fortunes of the Company, a graphical portrayal of which we attach as [Exhibit A](#).

Accordingly, on behalf of the Company, I recite the major allegations, specifics of which Respondent attempts to sidestep in the four broad categories enumerated in his letter of April 7 (“Response”), contained in the Complaint and shall cite specific documentation in exhibits attached hereto:

1. Misrepresented lawyer Raymond A. Joao by Christopher Wheeler, to the Board of Directors and investors of I View It, Mr. Joao presently of counsel to Dreier & Baritz¹, New York, N.Y. initially was represented as a Proskauer Rose attorney when he was not a member of such firm, but actually of counsel to one Meltzer Lippe Goldstein and Schlissel, Mineola, N.Y.

By Respondent’s admission in his Response to the Company’s Complaint, Mr. Joao is not now or was ever an employee of Proskauer, and I direct your attention to [Exhibit B](#),

¹ The Company, presently, has knowledge that Mr. Joao is no longer at Dreier & Baritz.



Lorraine Christine Hoffman, Esq.
4/30/2003
Page 3

wherein an email sent to Respondent and thereafter Respondent forwarded to Joao refutes this fact.

2. Misrepresented lawyer Kenneth Rubenstein by Christopher Wheeler as a member of Proskauer Rose, and presently a partner of Proskauer Rose, but at the initiation of contact, a partner of a one Meltzer Lippe Goldstein and Schlissel.

Respondent has represented that Mr. Rubenstein was a member of Proskauer since 1998, but Rubenstein himself as sworn in his November 20, 2002 deposition as part of the Litigation, where such Litigation is still wholly irrelevant to the Complaint, but is instructive for this allegation attached herein as [Exhibit C](#), does not recall the exact period of his joining Proskauer needing to be coached by Defendant's counsel²; the Company's contention is that Respondent, Proskauer, and Mr. Rubenstein while at the Meltzer firm began representing the Company in 1998, but Mr. Rubenstein was represented as a member of Proskauer.

Moreover, it was not until the Company questioned their estate planning contact at Proskauer (as further described by Exhibit C), and in turn Respondent, as to why Mr. Rubenstein was not listed on the Proskauer website nor in the phone directory at Proskauer, that Respondent claimed Mr. Rubenstein was in transition from the Meltzer firm and that we would need to execute a retainer with Meltzer and fund their work at Meltzer until Mr. Rubenstein and Mr. Joao would officially transfer to Proskauer. Accordingly, the Company was in need of retaining two firms (nearly four months elapsed after Mr. Rubenstein and Mr. Joao were working on the Company's inventions that a retainer agreement is executed with Meltzer) to the dismay of the Board of Directors ("Board") and investors, and all occurred after engaging Respondent and Proskauer, awarding them an equity interest in the Company, and agreeing that their bills would mainly be paid by future royalties from the patent pools overseen by Mr. Rubenstein and Respondent's content and technology clients; stemming from the Company's investigation and the Litigation, there is no evidence of Respondent conducting conflict of interest checks in regard to Respondent's and Proskauer's representation of the Company.

3. Failed to take reasonable steps to ensure that the intellectual property of the Company was protected.

² Deposition of Kenneth Rubenstein at 6, Proskauer Rose LLP v. Iviewit.com, Inc. et. al. Case No. CA 01-04671 AB (Circuit Court of the 15th Judicial Circuit in and for Palm Beach County, Florida filed May 2, 2001).



Lorraine Christine Hoffman, Esq.
4/30/2003
Page 4

The specifics of this allegation relate to the 2002 intellectual property review undertaken by the Company's patent review counsel, Greenberg Traurig LLP, the results of which we attach herein as [Exhibit D](#). Moreover, after the expenditure of some hundreds of thousands of dollars in patent prosecution work by three firms, Respondent and Proskauer as protagonist and overseer of Meltzer and Foley and Lardner, in the estimation of Greenberg Traurig and Blakely, Sokoloff, Taylor & Zafman LLP (Company's present patent prosecution counsel), the Company's patent applications are missing critical elements and are in need of further amendment, while they have already been previously amended, to cover the embodiment and/or scope of the original inventions.

Moreover, in rebutting Respondent's response to this specific allegation, the Company shall: (a) establish that Respondent was indeed involved with patent prosecution; (b) establish that the recruitment of his personal friend and business associate, Brian G. Utley, was to further his despicable malfeasances and misfeasances in his representation of the Company; and (c) point to the specific malfeasances and misfeasances in the preparation of Company patents by Respondent as self-appointed overseer of the Company's patent portfolio.

a. Pre-Appointment of Brian Utley as President & Chief Operating Officer

This subsection a. provides a convenient reference to the point in time and unequivocally points to Respondent's involvement in the patent prosecution process. Moreover, Respondent's claim to not be involved with the patent prosecution is fraught with error, and in diametric opposition to the following documentation attached herein as [Exhibit E](#):

- Letter from Respondent in January 1999 stating Proskauer was going to obtain patents for the Company and had already begun talking with Proskauer's patent attorneys in New York;
- Letter from Respondent to a one Richard Rossman stating that Proskauer patent counsel had reviewed the patentable inventions and secured a patent, allegedly Mr. Rubenstein and his underling, Mr. Joao were counsel;
- Letter from one Hassan Miah asking Respondent to contact Rubenstein as patent counsel for the Company;
- Rubenstein letter to the Company sending information on how to formulate initial patents;
- Company letter to Rubenstein regarding the invention processes; and
- Billings of Proskauer.



Lorraine Christine Hoffman, Esq.
4/30/2003
Page 5

Furthermore, Respondent asserted to the Company's stakeholders and included in all business plans that Proskauer had jointly authored patent filings and that Mr. Rubenstein was overseeing the work of the other attorney, Mr. Joao, referred by both Mr. Rubenstein and Respondent. Additionally, this is not a small item as many investors relied on the statements of Respondent and Rubenstein's involvement with the Company to invest some Five Million Five Hundred Thousand Dollars (\$5,500,000) in the Company, and were attracted by the statements of Respondent after he told them that Mr. Rubenstein had opined that the Company's technologies were "novel."

Additionally, Respondent participated in a eleven hour trip (of which the Company was billed and paid for) to Orlando, Fla. where he attended a highly technical meeting with Real 3D (then an Intel, SGI and Lockheed Martin consortium) where Respondent stated that Rubenstein had opined on the strength of the technologies and that the Company had completed provisional filings; when evaluated by the technical staff of Real 3D, a referral of Respondent's, they estimated the Company's inventions as capable of generating revenues in the billions of dollars annually as said inventions applied to all forms of video and imaging systems. Still further, Respondent stated that, with respect to Proskauer's patent work, the provisional³ applications were completed and filed, thus protection of the Company's inventions were in place (unfortunately, Respondent's claims were in error as the video inventions covered at meeting were not as of yet completed). It is interesting to note in Respondent's deposition in the Litigation attached as [Exhibit F](#), where such Litigation is still wholly irrelevant to the Complaint, but instructive for this allegation, he claims that he was unaware of video inventions until the meeting with Real 3D⁴ and this is contrary to much evidence that the invention was created far before the meeting and Respondent had full knowledge of such inventions with Mr. Rubenstein and Mr. Joao (as further described by Exhibit F); this results in the Company's video inventions provisionally filed six months later than disclosure to Respondent and Mr. Joao, and whereas the imaging invention as well was filed three months later than originally envisioned by the Company .

Additionally, Respondent held copies of all patents in his office, and, factually, had been the intermediary of patent draft delivery between Mr. Joao and Mr. Bernstein since on or about April 1, 1999; presently, as a result of a granted Motion in the Litigation, where

³ For information purposes, provisional filings can be as short as a one page disclosure, and that a non-provisional filing (what industry participants commonly refer to as a patent application) must be made within one year of the provisional filings and must include claims to what the descriptive invention protects. It is the claims of the patent, when pointing to the descriptive body, that issued patent holders litigate in any patent infringement suit.

⁴ Deposition of Christopher C. Wheeler at 168, Proskauer Rose LLP v. Iviewit.com, Inc. et. al. Case No. CA 01-04671 AB (Circuit Court of the 15th Judicial Circuit in and for Palm Beach County, Florida filed May 2, 2001).



Lorraine Christine Hoffman, Esq.
4/30/2003
Page 6

such Litigation is still wholly irrelevant to the Complaint, but is instructive for this allegation, the Company fails to find many relevant documents in their records.

Finally, Respondent passes information from Mr. Rubenstein that everything was “OK” on several key issues regarding the patents, making those representations to the Company’s Board and the investors; Foley and Lardner, a subsequent patent counsel, taped conversations wherein Respondent opined on Joao errors and, acting as counsel, represented why the errors are “OK” in Joao’s work.

b. Post-Appointment of Brian Utley as President & Chief Operating Officer.

This subsection provides a convenient reference to the point in time and unequivocally points to Respondent’s involvement in the patent prosecution process, only this time with the recruitment of one Brian G. Utley who, from this point forward, aids and abets Respondent’s malfeasances and misfeasances in representation of the Company.

Moreover, upon referral by Respondent, the Company appoints Mr. Utley as President & Chief Operating Officer of the Company on or about September 1999; Mr. Utley began working for the Company and reviewing the provisional patent filings on or about June 1999. Furthermore, in Respondent’s self appointed role as overseer of the Company’s patent portfolio, the evidence of which is attested to by 3.a. above and Exhibit E in collusion with Mr. Utley, the Company finds Mr. Utley, after his termination by the Company, and through the investigative work of Blakely Sokoloff Zafman & Taylor LLP, writing Company inventions into his own name without assignment to the Company, and sent to his home address, using patent attorney William J. Dick of Foley and Lardner, Milwaukee, Wis.; Respondent played a big role in recommending Mr. Dick as the Company’s new patent counsel. Moreover, Mr. Dick was the patent attorney for Mr. Utley in his alleged misappropriations of intellectual property for his past employer, Diamond Turf Lawnmower (see section 9 below).

More specifically, Respondent, in collusion with Mr. Utley when concerning the patent application referenced directly above that was malfeasantly written into Mr. Utley as inventor and malfeasantly not assigned to the Company, further aids and abets a one Ryjo, Inc. and its founder, Ryan Huisman, in Ryjo’s attempt, with the aid of Respondent and Mr. Utley, to claim ownership of one of the Company’s inventions, an imaging applet (a.k.a. Zoom and Pan Imaging Design Tool as in U.S. Provisional Patent Application No. 60/233,341 and a.k.a. the Ryjo Phokus Zoom and Pan Applet⁵,

⁵ As background for this example in this allegation, Mr. Huisman was a former employee of Real 3D, wherein he had the benefit of the Company’s teachings, and is yet another example of Respondent’s failing to enforce Confidentiality Agreements on behalf of the Company (see Section 4) though such was



Lorraine Christine Hoffman, Esq.

4/30/2003

Page 7

collectively “Applet⁶”). Moreover, once Ryjo is proficient in this Applet, Respondent and his charge at Proskauer, a one Donald E. “Rocky” Thompson who also is an attorney not normally assigned the task of drafting a technology licensing agreement which is a complex, technical document normally assigned to a member of the U.S. Patent Bar, draft an agreement whereby the Company will enter into a transaction to own a fifty percent interest in the Ryjo Phokus Zoom and Pan Applet, one of the Company’s inventions that Ryjo is using in direct violation of the Real 3D Confidentiality Agreement, of which Respondent and Utley have full knowledge.

Moreover, had Respondent been diligent in his role as overseer of the Company’s patent portfolio, the evidence of which is attested to by 3.a. above and Exhibit E in collusion with Mr. Utley, Mr. Utley and Ryjo, Inc. would not have been able to attempt to abscond with the Company’s inventions, a true copy attributable to the Mr. Utley reference of which is attached as [Exhibit G](#). Fortunately for the Company, Mr. Utley had a provision in his Employment Agreement that gave the Company limited power of attorney to assign any inventions made by Mr. Utley to the Company (the Company incurred additional expense as a result of Respondent’s negligence, such assignment of which a true copy is attached herein as [Exhibit H](#).) Furthermore, although subsequently abandoned, Respondent’s negligence in this matter in his self appointed role as overseer of the Company’s patent portfolio, the evidence of which is attested to by 3.a. above and Exhibit E in collusion with Mr. Utley, these abandoned patent applications may provide exposure to the Company’s pending patent applications per present patent counsel Blakely Sokoloff Taylor & Zafman LLP.

Lastly, during Mr. Utley’s tenure, and attached as [Exhibit I](#), the Company presents the following documentation:

- Letter from one David Colter, former Vice President of Advanced Technology for Warner Bros., stating that he and other representatives of Warner Bros. have knowledge of favorable opinions by Rubenstein regarding the Iviewit patents to AOL Time Warner and Warner Bros representatives;
- Utley statement that he was counseled by Rubenstein as a Company advisor;

agreement executed with Real 3D, and also said agreement appears nowhere in Respondent’s files under a Court order to produce ALL files.

⁶ An applet is a program written in the Java™ programming language that can be included in a web page, much in the same way an image is included. Moreover, when using a Java technology-enabled browser to view a page that contains an applet, the applet’s code is transferred to your system and executed by the browser’s Java Virtual Machine (JVM). In the Company’s case, said Applet contains proprietary algorithms that allow for the varied zooming magnifications and other proprietary functionalities.

10158 Stonehenge Circle, Boynton Beach, Fla. 33437 • T (561) 364-4240 • www.iviewit.com

Proprietary & Confidential



Lorraine Christine Hoffman, Esq.

4/30/2003

Page 8

- Company Private Placement Memorandum (“PPM”) approved, authored, disseminated, and billed for by Respondent stating Rubenstein as Advisory Board member, and delivered to, among various others, Wachovia Securities, Inc⁷, and wherein the language refers to Mr. Rubenstein as a retained attorney of the Company⁸, and where said PPM erroneously claims Utley as a graduate of San Francisco City College^{9 10};
- Oppositely, the deposition of Mr. Rubenstein¹¹ (it is interesting to note that Proskauer alleged that Mr. Rubenstein did not know the Company and thus did not need to be deposed; needless to say, as the Litigation has proceeded, Judge Labarga has ordered Mr. Rubenstein to testify and then later after he claims privilege for questions refuses to answer other questions, Judge Labarga has again summoned him to yet another deposition to answer the questions he refused to answer at his first deposition);
- Proposed Ryjo, Inc. Agreement; and
- Comments on proposed Ryjo, Inc. Agreement¹² by Douglas Boehm of Foley and Lardner.

c. Specific malfeasances in the preparation of Company patents by Respondent as self-appointed overseer of the Company’s patent pool, the evidence of which is attested to by 3.a. above and Exhibit E in collusion with Mr. Utley.

Following directly upon establishing Respondent’s role as self-appointed overseer of the Company’s patent pool, the evidence of which is attested to by 3.a. above and Exhibit E in collusion with Mr. Utley as evidenced by 3.b. above, what follows is the result of Respondent’s malfeasances in collusion with Utley presented in terms of the video inventions¹³ attached herein as [Exhibit J](#):

- The Company’s technology specification for the video invention;
- Respondent’s, in his role as self-appointed overseer of the Company’s patent pool, as evidenced by 3.a. above and Exhibit E in collusion with Mr. Utley,

⁷ Iviewit Holdings, Inc., Confidential Private Placement Memorandum at 30 (unpublished manuscript, on file with the Company).

⁸ *Supra* note 7, at 4.

⁹ *Supra* note 7, at 27.

¹⁰ Deposition of Brian G. Utley at 94-95, Proskauer Rose LLP v. Iviewit.com, Inc. et. al. Case No. CA 01-04671 AB (Circuit Court of the 15th Judicial Circuit in and for Palm Beach County, Florida filed May 2, 2001)..

¹¹ *Supra* note 2, at 11-12.

¹² Iviewit Holdings, Inc., Website Development Agreement at 4 (unpublished manuscript, on file with the Company).

¹³ A similar analysis for the imaging invention is available upon request.



Lorraine Christine Hoffman, Esq.
4/30/2003
Page 9

- submission of the video disclosure;
- The provisional patent filing; and
- The non-provisional patent filing.

Clearly, by this Exhibit J, Respondent clearly fell outside the norms of reasonability as Company counsel, in protecting the lifeblood assets of his client.

4. Allowed the infringement of patent rights of the Company and the intellectual property of the Company by other clients of Proskauer and Rubenstein. Failed to submit to patent pools overseen by Rubenstein Iviewit patents for inclusion to such pools, including but not limited to MPEG 2, MPEG 4, and DVD.

More specifically, since Company patents have not been issued, Respondent upon introduction of potential licensees to the Company (many meetings of which he personally attended, billed, and was paid for said introductions), fails to enforce the Confidentiality Agreements he personally drafted or oversaw against companies attached herein as [Exhibit K](#), a list of which is not exhaustive, and corroborated by a letter of Mr. Colter, wherein he additionally states that Warner Bros had spoken with Mr. Rubenstein who provided solid support for the Company's patents. Similarly, among one of the most grievous alleged misfeasances, Respondent as self-appointed overseer of the Company's patent pool, the evidence of which is attested to by 3.a. above and Exhibit E in collusion with Mr. Utley, fails to take even one step towards introducing the Company's inventions to the multimedia patent pools aforementioned (MPEG 2, MPEG 4, DVD). From the URL at http://www.mpegla.com/news/n_02-09-11_jvt.html, the application process is merely submitting a patent, together with a fee of Eight Thousand Five Hundred Dollars (\$8,500) per patent to cover the costs of the aforementioned Mr. Rubenstein in his role as the patent evaluator.

Still further, the Company has reason to believe that said multimedia patent pools presently use the Company's inventions without compensation to the Company¹⁴.

5. Failed to and/or inadequately completed work regarding patents, copyrights and Trademarks.

With respect to patents, we reference Respondent's role as self-appointed overseer of the Company's patent portfolio, the evidence of which is attested to by 3.a. above and Exhibit E in collusion with Mr. Utley. Moreover, when the Company finally received the provisional filings of Mr. Joao, there were multiple instances of documents that appear as

¹⁴ Especially the storage requirements inherent in DVD encoding and replication and the Video on Demand initiatives of cable operators utilizing MPEG 2 compression via digital cable.



Lorraine Christine Hoffman, Esq.

4/30/2003

Page 10

fraudulent submitted to Respondent, the U.S. Patent and Trademark Office, and the Company; inventors were missing from the filings, switched content in the filed patents vis a vis what the Company had instructed Mr. Joao through Respondent to file, and in some instances faxes that are transmitted in the year 1900; in all Respondent did not exercise the degree of care necessary in his role as self-appointed overseer of the Company's patent portfolio, the evidence of which is attested to by 3.a. above and Exhibit E in collusion with Mr. Utley. Subsequently, Respondent advised the Board that after Mr. Rubenstein's review of the patents there might have been some errors but that everything was "OK." Lastly, the Company references teleconference transcripts attached herein as [Exhibit L](#), wherein Respondent opines on the adequacy of the patent work performed by Mr. Joao (compare this to Respondent's deposition in the Litigation of Exhibit F) and further supporting the contention that problems existed in the filings by Mr. Joao and overseen by Respondent and Rubenstein, that would eventually expose the Company to massive shortfalls in projected revenues, cash flow, and net income.

As for copyrights, essentially, the Company's technologies are an intricate series of steps to manipulate video and image frames, and to seamlessly work together, said steps are best served by the writing of a basic source code to complete such steps over the many frames and images in any given video. Moreover, while the steps of the invention are patentable, the basic code connecting the steps is not, but is eligible for copyright protection. Respondent never obtained the copyright for the basic source code, yet billed the Company for it, absent the common law, unenforceable, copyright entitled to any author upon completion of his writing.

6. Engaged in unnecessary and duplicate corporate and other work.

The Company's references the sworn testimony of Brian G. Utley in the Litigation, where such Litigation is still wholly irrelevant to the Complaint, but instructive for this allegation attached herein as [Exhibit M](#)¹⁵.

7. Submitting false resumes for President candidate Brian Utley.

The Company attaches the submitted resume of Mr. Utley by Respondent and the footnoted excerpts from depositions in the Litigation cited below as 16 and 17, where such Litigation is still wholly irrelevant to the Complaint, but instructive for this allegation herein as [Exhibit N](#), which misrepresents Mr. Utley's, tenure and termination at Diamond Turf Lawnmower, and the involvement of, recommended by Respondent and Mr. Utley, Company patent counsel Mr. Dick in said Diamond Turf Lawnmower circumstances. Moreover, from the first of Respondent's introduction of Mr. Utley to the Company, and although Respondent is continually copied on Mr. Utley's biography in

¹⁵ Supra note 10 at 26.



Lorraine Christine Hoffman, Esq.
4/30/2003
Page 11

various drafts of Company business plans authored by Respondent, and Respondent's representations of Mr. Utley to various Board members, Respondent claiming he was unaware of Utley misrepresentations¹⁶, was negligent in recommending and forcing the appointment of Mr. Utley as the only means for the Company to secure the seed investment of Huizenga Holdings, one of Respondent's referrals, without Respondent's own prior independent background checks of Mr. Utley, though by Respondent's testimony therein, states he had known Mr. Utley in social surroundings since 1990, had formed a corporation with him on or about 1994, continues to know Mr. Utley in social surroundings until introduction to the Company in 1999, and thereafter serves as his chief outside counsel and self-appointed overseer of the Company's patent portfolio, the evidence of which is attested to by 3.a. above and Exhibit E in collusion with Mr. Utley; Mr. Utley, for his part, claims Respondent was aware the circumstances¹⁷.

Additionally, the Company's references the sworn testimony of Brian G. Utley in the Litigation, where such Litigation is still wholly irrelevant to the Complaint, but instructive for this allegation wherein Mr. Utley directly refutes parole evidence collected by the Company from Monte Friedkin¹⁸ of Diamond Turf Lawnmower who relates to the Company that Mr. Utley's tenure was marred by misappropriations of intellectual property naming Mr. Utley as an inventor written with the assistance of William Dick of Foley and Lardner, Milwaukee, Wis. Mr. Friedkin shall testify that these malfeasances led to the closure of his business in diametric opposition to the aforementioned resume of Mr. Utley, a biography that Respondent authored, reviewed, and approved for the Wachovia Securities, Inc. Private Placement Memorandum, among others.

8. Recommendation by Mr. Wheeler and Mr. Utley of William Dick as patent counsel for I View It without disclosure that Mr. Dick had been involved in patent malfeasances with Mr. Utley's former employer Diamond Turf products.

Upon the conclusion that the provisional patent filer for the Company, Mr. Joao, under the oversight of Respondent, the evidence of which is attested to by 3.a. above and Exhibit E in collusion with Mr. Utley, had done a poor job of capturing the inventions, Respondent and Mr. Utley suggest, as Mr. Joao's replacement, a one William Dick of Foley and Lardner, Milwaukee, Wis. Unbeknownst to the Company, it was Mr. Dick who had been involved with Mr. Utley regarding intellectual property disputes at the Diamond Turf Lawnmower company; Respondent, owing a duty of diligence and care in

¹⁶ *Supra* note 4 at 117-120.

¹⁷ *Supra* note 10 at 244.

¹⁸ Mr. Friedkin is available for questions as indicated in his inclusion on the Witness list as part of the Complaint.



Lorraine Christine Hoffman, Esq.
4/30/2003
Page 12

referring the Company to other legal professionals, did not disclose such happenings by and between Mr. Dick, Mr. Utley, and Diamond Turf Lawnmower¹⁹.

Moreover, equally devastating to the Company's prospects, under the oversight of Respondent as the self-appointed overseer of the Company's patent portfolio, the evidence of which is attested to by 3.a. above and Exhibit E in collusion with Mr. Utley, Respondent's referral of Mr. Dick results in the filing of patents with: (i) incorrect math; (ii) further filing patents with missing inventors with full knowledge of the rightful inventors; (iii) changing patent titles and content to harm the Company's prospects; (iv) without any knowledge of the Company, filing of patents into Mr. Utley's own name, with no assignment to the Company for Company inventions in an attempt to enrich Mr. Utley similar to the contentions of Mr. Utley's past employer, Diamond Turf Lawnmower; and (v) the incorrect conclusion that certain patent bodies could not be rewritten as they contain new subject matter, in contradiction to the views of the Company's current patent review counsel.

9. Mr. Wheeler transacted stock/securities to Tiedemann/Prolow, another referral friend of Mr. Wheeler, without proper documentation, nor Board approval.

More specifically, Respondent represented the Company in the issuance of corporate securities, without Board approval or executed documents. Moreover, once revealed to the Board, the members showed a grave concern for this matter when the Tiedemann/Prolow group was introduced by Respondent; Respondent drafted the transaction and negotiated the transaction on behalf of the Company, yet leaving no executed documents in the Board's possession from which to measure the terms and conditions of said transaction wherein the Company references the letter of Board member, Donald Kane an ex-managing partner of Goldman Sachs regarding Company concerns attached herein as [Exhibit O](#).

Furthermore, and even more negligent, Respondent drafted, negotiated, and approved for execution a Warrant grant to Tiedemann/Prolow at an exercise price so low (approximately \$155.00 per share) in comparison to the Company's valuation (approximately \$387.59 per share) that, upon execution by Mr. Raymond Hersch as Chief Financial Officer, said exercise price immediately triggered the antidilution clauses of the Company's lead investor, Crossbow Ventures and another of Respondent's referrals, to the detriment of other Company shareholders as a whole (as further evidenced by Exhibit O).

¹⁹ The Company invites The Florida Bar to further inquire of Monte Freidkin of Diamond Turf Lawnmower the circumstances surrounding these issues (Address and phone number are part of the witness list).



Lorraine Christine Hoffman, Esq.
4/30/2003
Page 13

Still further, the Company alleges the conversion and misappropriation by Respondent, with the assistance of Mr. Utley and Bruce Prolow, a principal of the Tiedemann/Prolow investor in question, of some Six Hundred and Fifty Five Thousand Dollars (\$655,000) in Company funds. During the discussions surrounding the Tiedemann/Prolow investment, the target investment was One Million Dollars (\$1,000,000). Moreover, at the time of the wire transfer of Tiedemann/Prolow funds, which turned out to be Three Hundred and Forty Five Thousand Dollars (\$345,000), and allegedly February 23, 2001, employees witnessed a large, steel suitcase full of cash, evidenced by [Exhibit P](#), in the Company's research and development laboratory, wherein Michael Reale, Mr. Utley's Vice President of Operations, stated that it was from a Company investor.

Lastly, Respondent was requested by several Board members to attend a series of follow-up Board meetings to explain his actions, Board meetings at which he failed to appear; thereafter, as stated above, Mr. Utley was terminated and Mr. Wheeler terminated legal services immediately, Mr. Utley filed a breach of contract complaint and, subsequently, an involuntary bankruptcy petition, and Respondent filed the Litigation, all a series of coordinated actions by Mr. Utley and Respondent against the Company to burden the Company in an attempt to cover up these and other malfeasances and misfeasances; shortly thereafter, Mr. Utley allegedly surfaced at Mr. Prolow's distance learning company, InternetTrain.com, allegedly together with stolen proprietary Company equipment, and perhaps the diverted \$655,000 of Company funds.

10. Knowing and willful destruction of Company records.

The Company references the deposition of Eliot I. Bernstein attached herein as [Exhibit Q](#) with respect to the alleged destruction of documents wherein it is equally telling that Respondent's counsel was misleading the Court in the meaning of destruction of documents²⁰. Moreover, in his deposition, where Mr. Bernstein states that documents that were not put forth under the Honorable Jorge Labarga's order to have ALL documents, but noticeable by Mr. Bernstein and Steven M. Selz, Esq., attorney for the Defendant, ALL documents were not included in the set of documents put forth by Respondent, and thus were missing and, therefore in the Company's and Mr. Bernstein's opinion, destroyed, Respondent is in direct violation of the Court order to present ALL documents.

Furthermore, of the many folders, of which the Company can submit taped review and pictures to illustrate, Mr. Bernstein and Mr. Selz noticed a mass of folders missing all

²⁰ Deposition of Eliot I. Bernstein at 235-239, Proskauer Rose LLP v. Iviewit.com, Inc. et. al. Case No. CA 01-04671 AB (Circuit Court of the 15th Judicial Circuit in and for Palm Beach County, Florida filed May 2, 2001).



Lorraine Christine Hoffman, Esq.
4/30/2003
Page 14

documents, allegedly pointed to the destruction of the documents supposed to be in those folders, and wherein Respondent would be in violation of the Court's order to present ALL documents for review. Additionally in said deposition, it is clear that Respondent's counsel claims that, paraphrasing, "they may be on shelves and not procured for review," wherein Mr. Bernstein states that ALL the documents were under a Court order for review, Respondent's counsel retracts his statement that there is anything on the shelves and thus Mr. Bernstein claims that the documents were therefore destroyed. Finally, in further questioning of Mr. Bernstein, Respondent's counsel thereafter states, "So destroyed means missing to you...Right. Why don't you go buy a dictionary? There's a Barnes & Noble's down the street...", as Respondent's counsel believes "destroy" does not include, refer, or infer the term "missing," and quickly closes his questioning and the deposition.

Lastly, as Barnes & Noble's is a convenient venue for information, the Company opts for a more cost effective form of information gathering and references the URL at <http://www.onelook.com> and selects the Webster's 1828 dictionary's definition of "destroy" finding:

DESTROY, v.t. [L. To pile, to build.]

1. To demolish; to pull down; to separate the parts of an edifice, the union of which is necessary to constitute the thing; as, to destroy a house or temple; to destroy a fortification.
2. To ruin; to annihilate a thing by demolishing or by burning; as, to destroy a city.
3. To ruin; to bring to naught; to annihilate; as, to destroy a theory or scheme; to destroy a government; to destroy influence.
4. To lay waste; to make desolate.
5. Go up against this land, and destroy it. Is. 36
6. To kill; to slay; to extirpate; applied to men or other animals.
7. Ye shall destroy all this people. Num. 32.
8. All the wicked will he destroy. Ps. 145.
9. *To take away*²¹; to cause to cease; to put an end to; as, pain destroys happiness.
10. That the body of sin might be destroyed. Rom 6.
11. To kill; to eat; to devour; to consume. Birds destroy insects. Hawks destroy chickens.
12. In general, to put an end to; to annihilate a thing or the form in which it exists. An army is destroyed by slaughter, capture or dispersion; a forest, by the ax, or by fire; towns, by fire or inundation, &c.

²¹ Emphasis supplied.



Lorraine Christine Hoffman, Esq.
4/30/2003
Page 15

13. In chemistry, to resolve a body into its parts or elements.

And its synonym, “suppress” finding:

SUPPRESS', v.t. [L. suppressus, supprimo; sub and premo, to press.]

1. To overpower and crush; to subdue; to destroy; as, to suppress a rebellion; to suppress a mutiny or riot; to suppress opposition.
2. Every rebellion when it is suppressed, makes the subject weaker, and the government stronger.
3. To keep in; to restrain from utterance or vent; as, to suppress the voice; to suppress sighs.
4. *To retain without disclosure; to conceal; not to tell or reveal; as, to suppress evidence.*²²
5. She suppresses the name, and this keeps him in a pleasing suspense.
6. To retain without communication or making public; as, to suppress a letter; to suppress a manuscript.
7. To stifle; to stop; to hinder from circulation; as, to suppress a report.
8. To stop; to restrain; to obstruct from discharges; as, to suppress a diarrhea, a hemorrhage and the like.

Consequently, the Company maintains that if the Court ordered Respondent to present ALL records for viewing and copying, and should it be apparent to Mr. Selz and Mr. Bernstein that known records are not included, then it would follow that said records are “missing”, and if such “missing” records are not shelved as Respondent’s counsel maintains, then such “missing records” have been “taken away or destroyed” and still further if “taken away or destroyed” then said records were “retained without disclosure; to conceal; not tell or reveal; as, to suppress evidence,” all in violation of the Court order to present ALL records, and in support of the Company’s Complaint.

Secondly, the Company references the general ledger of Company bills with Respondent and Proskauer attached herein as [Exhibit R](#). Moreover, as evidenced by Exhibit R, the first invoice of June 18, 1999 and the second invoice of August 24, 1999 total One Hundred and Sixty Five Thousand Five Hundred and Thirty Dollars and Fifty Five Cents (\$165,530.55) in billings for a developmental stage company, a development stage company with no employees lest the inventors, a developmental stage company with no employees and no office space, a developmental stage company with no employees and no office space and no executed business development agreements.

Furthermore, at this volume of billings and assuming Respondent was the sole billing attorney at this juncture, this volume of work represents approximately four hundred and thirty (430) billing hours for a developmental stage company with no employees and no

²² Emphasis supplied.



Lorraine Christine Hoffman, Esq.
4/30/2003
Page 16

office space and no executed business development agreements. Despite many requests for the itemized bills, and despite a court order in place to present ALL records, the Company still finds disclosure, not even lacking, but non-existent, and leaves the fact of just what Respondent was doing in these 430 hours as the “Eighth Great Wonder of the World,” unless he was, as the Company alleges, overseeing, directing, controlling, feloniously opining, sometimes impeding, altogether unfavorably aiding and abetting, and otherwise positioning himself between said patent prosecutions, his other clients, and the inventors.

11. Failing to list proper inventors of the technologies on the patents, and thereby submitting false and fraudulent patents to the US Patent and Trademark office based on improper legal advise by Wheeler that foreign inventors could not be listed until their immigration status was adjusted leading to further erroneous billings by Proskauer Rose for frivolous immigration work.

Respondent as the self-appointed overseer of the Company’s patent portfolio, the evidence of which is attested to by 3.a. above and Exhibit E in collusion with Mr. Utley, fails to supervise the insertion of the proper inventors, so that wherever all of, and only, Eliot I. Bernstein, Jude Rosario, and Zakirul Shirajee²³ (and in one case, Jeffrey Friedstein) do not appear as in the Company’s marked up draft in [Exhibit S](#) versus the similarly attached intellectual property docket of Blakely, Sokoloff, Taylor & Zafman LLP attached herein, the resulting patent application are subject to invalidation at issuance; this is also an instance of Respondent’s negligence in his role as the self-appointed overseer of the Company’s patent portfolio, the evidence of which is attested to by 3.a. above and Exhibit E in collusion with Mr. Utley, when viewing the Blakely docket and witnessing how many other patent applications name Mr. Utley as an inventor.

12. Failure to communicate with Company to the detriment of the Company, and in certain instances communication of false materials to the Company.

Former Board director Mr. Kane and other members of the Board were concerned over a proposed transaction by Respondent and Mr. Utley whereby the Company would undertake a merger with a distance learning company; the legal bills incurred for this unauthorized proposed transactions were horrific. Moreover, Mr. Utley arranged transportation for representatives of said distance learning company; Board members

²³ Mr. Shirajee has submitted taped conversations whereby he states that he met Respondent and Mr. Joao, reviewed patents, attended meetings with Respondent and Mr. Utley at Real 3D, and executed invention papers.



Lorraine Christine Hoffman, Esq.
4/30/2003
Page 17

were so disturbed they asked the distance learning representatives to leave, and notified Mr. Utley that they were all equally concerned with his new investor, Tiedemann/Prolow, the fact that no documents were circulated or in place for the investment. Mr. Prolow, a principal of the investor who received such securities in the Company and a Company director at that time, was also the owner, whether directly or in his capacity of a principal of a Tiedemann/Prolow, of a minority interest of the distance learning company.

Moreover, as a result of Respondent unauthorized structuring of this aborted merger transaction as well as the Tiedemann/Prolow investment, the Company suffered to temporary loss of computers that were stolen, and that contained both highly confidential proprietary processes and corporate records; the Company has reason to believe that said stolen property was taken to Mr. Prolow's distance learning company in New Jersey.

13. Lastly, the negligent actions of Wheeler and Proskauer resulted in and were the proximate cause of loss to the Company.

The history of the Company, literally back to the first day of discovery of the inventions, sees the allegations described in Defendant's Motion for Leave to Amend to Assert Counterclaim for Damages, Proskauer Rose LLP v. Iviewit.com, Inc. et. al., Case No. CA 01-04671 AB (Circuit Court of the 15th Judicial Circuit in and for Palm Beach County, Florida filed May 2, 2001) attached herein as [Exhibit T](#), a motion of which stems from that certain Litigation that is still wholly irrelevant to the Complaint, but is instructive for this allegation, as all relating back to a very small group of attorneys overseen by Respondent as graphically described by Exhibit A, and after review by the Company's present patent review counsel, the work product overseen by Respondent result in the causing of damages to the Company over a twenty year patent life, as described in the Company's projections across all distribution channels as evidenced by [Exhibit U](#) attached herein.

Moreover, that upon the discovery of the above referenced events, the Company's lead investor, Crossbow Ventures, ceased funding of the Company. Furthermore, Crossbow Ventures, a referral of Respondent, obtained a security interest in the Company's inventions, under the guise of protecting the Company against the actions of Respondent and Mr. Utley, when factually, such conduct was motivated by Crossbow's attempts to wrongfully interfere with the interests of the Company in its inventions; such conduct, upon information in possession of the Company, was undertaken with the assistance of Respondent and Mr. Utley as described and attached herein as [Exhibit V](#).

Presently, as a result of Respondent's malfeasances and misfeasances, the Company may have suffered proximate damages to its entire international patent portfolio as Office



Lorraine Christine Hoffman, Esq.
4/30/2003
Page 18

Actions, perhaps indefensible by the Company, have issued that relate to a critical part of the Company's technology seen as its largest revenue driver.

Additionally, Ms. Hoffman, the Complaint, contrary to the contradictions and feints ascribed to by Respondent, was borne from almost two year's investigative work by Company management, Caroline P. Rogers, Esq., and, under her direction, Mr. Selz, when viewed in light of our fiduciary responsibilities as officers and directors to the Company's shareholders rather than some "Hail Mary" vendetta theory as a result of a denied motion in the Litigation, fiduciary responsibilities of which we take very seriously in light of the large amount of capital invested by prominent business and entertainment people to date.

Moreover, in assembling all of these issues into a coherent picture of what transpired, the Company has found corporate records and attorney files missing or destroyed, computer files mysteriously formatted and reformatted, stolen equipment, the locking of the Company's domain, the "hackings" of the Company email server, web server, and other electronic equipment and computer virus infections of same, and, last but not least, the breaking and entering on many occasions to the private homes of the Company's founder, Eliot I. Bernstein. Accordingly, it has been a monumental task to piece the series of events together from former members of the Board, investors, past employees not involved in the conspiracy, the relevant facts and documents to support these allegations.

Lastly, the Company urges The Florida Bar to question each and every individual referred by Respondent to the extent of their involvement in any wrongdoings, as it is clear by Respondent's response to the Complaint that, to this very day, and wherein he acknowledges the seriousness of the matters surrounding the Complaint, he continues his habitual, megalomaniacal, in collusion with Mr. Utley, compulsive speaking of falsehoods wherein, yet again, contradictions exist in Respondent's response vis-à-vis his testimony in the deposition with respect to the Litigation, wherein that certain Litigation while still wholly irrelevant to the Complaint is instructive for this, and yet another, example of the compulsive falsehoods spoken by Respondent when it concerns, in this among many cases, the issues surrounding the formation of the consulting company of Mr. Utley, and attached herein as [Exhibit W](#)^{24 25 26}.

Moreover, in the Company's view, it is of interest to note that although what Mr. Selz, Ms. Rogers, and the Company have termed a "conspiracy" while it involves many people, all those roads in said "conspiracy" lead to Respondent and his referrals.

²⁴ Supra note 4 at 119.

²⁵ Supra note 10 at 109.

²⁶ Christopher C. Wheeler, *Response to Complaint of Eliot Bernstein Against Christopher Wheeler*, *The Florida Bar File No. 2003-51,109 (15C)* 6 (April 7, 2003).



Lorraine Christine Hoffman, Esq.
4/30/2003
Page 19

Alternatively, of the countless other investors, employees, and professionals involved with the Company not a single instance of malfeasance or misfeasance has been leveled against any other individuals other than Respondent and his referrals, whether they be the following well respected businessmen, lawyers, law firms, and philanthropists not introduced by Respondent, including but not limited to: Wayne Huizenga, Wayne Huizenga Jr. (seed investors), Alan Epstein, Esq., Michele Mulrooney, Esq., Kenneth Anderson, CPA, Donald Kane (ex-managing partner of Goldman Sachs), James Osterling, James Armstrong, Blakely Sokoloff Taylor & Zafman LLP (present patent counsel), Irell and Manella (law firm), Armstrong Hirsch Jackoway Tyerman & Wertheimer (law firm), Ellen DeGenres (shareholder), Alan Young (shareholder), Allan Shapiro (Atlas Entertainment – shareholder), Mitchell Welsch (UBS Paine Webber), Jeffrey Friedstein (Goldman Sachs, shareholder) and many more esteemed individuals represented on the witness list sent to The Florida Bar as part of the Complaint.

In closing, Ms. Hoffman, and contrary to the contradictions and feints of Respondent, it should be apparent that by filing this Complaint and the Motion of Exhibit T, a motion of which stems from that certain Litigation that is still wholly irrelevant to the Complaint, but is instructive for purposes of the Company's Complaint, the Company, nor Mr. Bernstein, nor myself were acting unilaterally, but on the advice of competent counsel in the State of Florida and his associate Ms. Rogers who have levied these charges against Respondent, the ferocious attack on Mr. Bernstein is a not so well concealed attempt to ignore and deny some very damning facts, facts of which competent and licensed attorneys, who have reviewed the case and the evidence, have urged the filing of this Complaint. Moreover, it is the fiduciary responsibility of the Company and its officers and directors to call upon additional investigatory bodies to protect the Company and its stakeholders.

Finally, after the expenditure of nearly Five Million Seven Hundred and Fifty Thousand One Hundred and Forty Six Dollars (\$5,752,146) of total invested capital that includes, but is not limited to, approximately \$400,000 in payments of Respondent's past invoices, approximately \$50,000 of past legal billings by Meltzer Lippe Goldstein & Schlissel, approximately \$200,000 of past legal billings by Foley & Lardner, approximately \$145,000 of past legal fees in reviewing, repairing in part, and reassigning the Company's patent applications by Blakely, Sokoloff Taylor and Zaffman LLP, and approximately \$250,000 in future legal bills of Greenberg Traurig LLP, when viewing the malfeasances and misfeasances as detailed in this rebuttal, the facts of which, in the opinion of the Company, are clearly beyond dispute, we request you to force refund of those monies and are aware that such refunds sometimes occur. Additionally, with respect to the alleged conversion and misappropriation of Company funds enumerated in section 9 above, and if Respondent ultimately receives discipline, whether by admonishment, reprimand, suspension, resignation, or disbarment, the Company shall



Lorraine Christine Hoffman, Esq.
4/30/2003
Page 20

seek redress from the Clients Security Fund of The Florida Bar, wherein we shall file a claim in the fulfillment of our fiduciary responsibilities to the Company's shareholders.

Thank you for your diligent attention to this matter, Ms. Hoffman, and time is of the essence as international Office Actions have issued, the Company's patents are in need of repair, and the investments of the Company's stakeholders are in jeopardy.

Sincerely,

IVIEWIT HOLDINGS, INC.

By: _____
P. Stephen Lamont
Chief Executive Officer (Acting)



EXHIBIT A

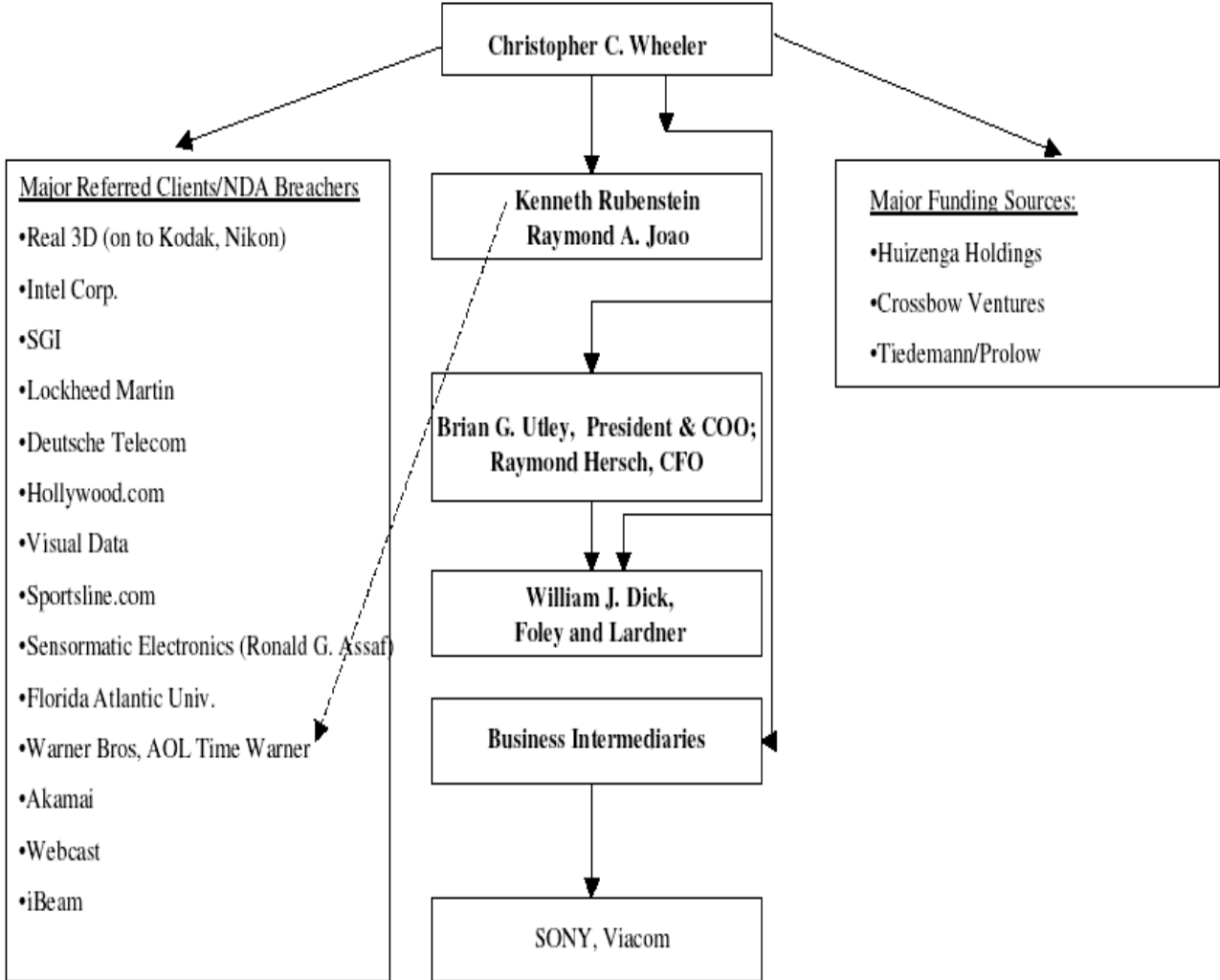



EXHIBIT B



-----Original Message-----

From: Eliot Bernstein [mailto:alps@netline.net]
Sent: Tuesday, February 23, 1999 7:53 AM
To: Kenneth Rubenstein (E-mail); Christopher C. Wheeler (E-mail)
Subject: Please call when you receive this message. 800.519.0234 or
561.417.8980

Ken,

Per our discussion, I have attached the following file = process.doc.

Eliot

<< File: ATT00027.html >> << File: PROCESS.doc >>

-----Original Message-----

From: Eliot Bernstein [mailto:alps@netline.net]
Sent: Friday, March 05, 1999 6:42 AM
To: Simon L. Bernstein (E-mail)

Subject: FW: Please call when you receive this message. 800.519.0234 or
561.417.8980

from the patent attorney at Proskauer

Eliot:

I got the e-mail. I looked over the materials. You have invented a process which appears to be a processing and/or manufacturing process for providing enhanced video images for use on the World Wide Web.

There appears to be no reason why we could not get an application out in a rather short time period to establish patent pending. I'll be out of the office until about 3:00 pm today, but I will call you when I get back.

Ray Joao 516-747-0300 x240

-----Original Message-----

From: Eliot Bernstein [SMTP:alps@netline.net]
Sent: Thursday, March 04, 1999 6:18 PM
To: Raymond A. Joao

Subject: FW: Please call when you receive this message. 800.519.0234 or
561.417.8980

10158 Stonehenge Circle, Boynton Beach, Fla. 33437 • T (561) 364-4240 • www.iviewit.com

Proprietary & Confidential



EXHIBIT C



DEPOSITION OF MR. RUBENSTEIN

1 Rubenstein

2 me, but I am going to put objections on the
3 record, if I want to.

4 Q. That's fine.

5 Now, starting off with, sir, could
6 you please state your full name?

7 A. Kenneth Rubenstein.

8 Q. "Kenneth Rubenstein." And where
9 is your place of employment currently,
10 Mr. Rubenstein?

11 A. Proskauer Rose.

12 Q. Where is that located?

13 A. 1585 Broadway, New York.

14 Q. And how long have you been
15 employed with Proskauer Rose?

16 A. About four, four-and-a-half years.

17 Q. Somewhere between 1997 and 1998
18 was your first date of employment?

19 A. I think it was in 1998.

20 Q. Do you remember a month?

21 A. Possibly June.

22 Q. June. Where were you employed



23 prior to your employment with Proskauer Rose?

24 A. I was with a law firm, Meltzer,

25 M-E-L-T-Z-E-R, Lippe, L-I-P-P-E.

-----Original Message-----

From: Eliot Bernstein [mailto:alps@netline.net]

Sent: Thursday, January 28, 1999 8:42 PM

To: 'agortz@proskauer.com'

Subject: Ken Rubenstein

Al,

I was unable to locate a contact at your firms website for Ken. I did find the following contacts, is he either one or both listed.

KENNETH RUBENSTEIN

[MELTZER LIPPE GOLDSTEIN WOLF & SCHLISSEL PC](#)

190 Willis Ave

Mineola, New York 11501-2639

Phone: (516) 747-0300

Fax: (516) 747-0653

krubenstein@mlg.com

Position: Member

New York Law School, New York, NY

Patent, Trademark & Copyright Law

or

KENNETH A. RUBENSTEIN

[BAER MARKS & UPHAM LLP](#)

805 Third Ave

New York, New York 10022-7513

Phone: (516) 741-5553

Fax: (212) 702-5941

Admitted: New York, 1983 New Jersey, 1983

Education: New York Law School, New York, NY

Areas Of Practice: Patent, Copyright and Trademark Law Trade Secret

Born: 1954



EXHIBIT D



<u>Provisional Application No.</u>	<u>Non- Provisional Application No.</u>	<u>Last Application Title</u>	<u>Greenberg Traurig Evaluation</u>
60,125,824	09,522,721	Apparatus and Method For Producing Enhanced Digital Video Images	Abandoned ²⁷
60,137,297; 60,155,404; 60, 169,559	09,587,734	System and Method For Providing an Enhanced Digital Video File	Description of the invention does not match claims
60,137,297; 60,155,404; 60, 169,559	09,587,026	System and Method For Playing Video	Description of the invention does not match claims
60,137,297; 60,155,404; 60, 169,559	09,587,730	System an Method For Streaming Video	Description of the invention does not match claims
60,125,824; 60, 146,726; 60, 149, 737; 60,155,404; 60, 169,559	09,630,939 continued from 09, 522, 721	System and Method For Producing an Enhanced Digital Image File	Need to revise claims across all communications networks ²⁸
N/A	Combined technologies		Never filed.

²⁷ Abandoned, as a result of the more robust filing of 09,630,939.

²⁸ From the original provisional filing of Mr. Joao, the environments claimed by this application are severely narrower than in the original disclosure of the Company.



EXHIBIT E



JANUARY 1999 LETTER OR RESPONDENT

Christopher C. Wheeler
Member of the Firm

Direct Dial 561.995.4702
cwheeler@proskauer.com

January 8, 1999

Eliot I. Bernstein
500 SE Mizner Boulevard
Suite 102
Boca Raton, FL 33432-6080

Re: Iviewit Legal Work

Dear Elliott:

I apologize for the delay in getting back to you. Our year end was quite hectic, but we are now focusing on your project and we are prepared to devote our full resources to it. We have reviewed your proposed business plan and offering with great interest. In helping you move this matter ahead, we would propose the following:

1. Formation of Corporation

We recommend that we immediately form a Florida corporation on your behalf. We would propose that the corporation be named Iviewit Corp. or Iviewit Corporation. We would also propose that the Florida corporation have 5 million authorized shares of common stock and one class of preferred stock. The common stock would be a 1¢ par value. The corporation would be formed immediately (we anticipate this could be completed within one or two days) and would be a C Corporation. The fees and costs associated with the formation would approximate between \$1,000 and \$1,500;

2. Additional Corporate Documentation

We would recommend that shareholders' agreements and perhaps employment contracts be prepared at this time. The shareholders' agreement is necessary because individuals other than yourselves will be involved as shareholders. The employment agreements, while not absolutely necessary, would help conceptualize your present relationship with the firm and would allow you to define your benefits now prior to the involvement of



Eliot I. Robinson
January 8, 1999
Page 2

investors. We anticipate that the preparation of these shareholders' and
agreements would cost approximately \$2,000 to \$3,000 depending upon
their complexity. We would recommend commencing this work immediately and would
anticipate that it could be completed within the next three weeks;

3. Protection of Intellectual Property Rights

We strongly recommend trademark and copyright protection of the Iviewit name under Federal law. This protection should be commenced immediately. In addition, if possible, strong consideration should be given to some patent or proprietary protection of the assemblage of software and the methodology used in connection with the production of Iviewit's services. We are presently discussing this protection with our New York intellectual property attorneys and verifying the appropriate fees and costs of each. We would propose to commence the trademark and copyright work immediately, and we would anticipate that the trademark/copyright matter would take approximately a month. The patent work should also be commenced now and may take considerably longer;

4. Offering Circular

In connection with your fund-raising efforts, we would propose to use your present business plan and offering as a base and revise it to provide the appropriate disclaimers and disclosures. In the event you raise capital from a limited number of accredited investors, we would anticipate that the cost of the revision of the offering memorandum would approximate \$5,000 - \$10,000. In the event that you begin to sell to non-accredited investors, we would need to expand the documents significantly. The cost could approximate \$15,000 to \$25,000. We are prepared to commence this work immediately and anticipate that it could be completed within the next few weeks;

5. Additional Corporate Work

From time to time, there will be additional corporate work most probably involving investment banks, underwriters, contracts, general corporate matters and securities matters. We will be available to handle this work on a daily basis. It is difficult to estimate what this would approximate dollar-wise since it will depend on what matters arise.

6. Staffing

We are prepared to dedicate whatever portion of our professionals' time is necessary to handle your matters successfully. We are prepared to offer you continuing corporate, intellectual property and other support as you may require in the years ahead. Your business is important to us and we will fully commit whatever resources are necessary to do the work quickly and to build what we hope will be a long-term relationship.

7. Fees

Generally, we will bill you monthly based on our hourly billing rates plus out-of-pocket expenses. All tactical and strategic decisions would be discussed with you and other members of your management team as appropriate.



Eliot I. Bernstein

January 19, 2009
Page 3
The lawyers who would be assigned to your matter have various billing rates. We would anticipate that most of your work be done by me, Rocky Thompson, Gayle Coleman and Mara Lerner Robbins. Our billing rates are \$385, \$275, \$220, and \$165 respectively.

Please note that in addition to attorneys' fees, you would also be responsible for out-of-pocket expenses for the cost of mailing, telephone, photocopying, faxes, hand deliveries and the like.

We are in a service business and that is the primary orientation of our Firm; we believe in a thoughtful but rapid response to our clients needs in delivering value for our client's money. We believe we have a non-nonsense approach in providing the best in legal services. We welcome the opportunity to handle Iviewit's initial legal work and look forward to continuing to service your future legal needs.

Please call me at your earliest convenience. We are prepared to form the corporation and commence trademark and copyright protection upon your authorization.

Sincerely,

Christopher C. Wheeler

CCW/gb



LETTER OF RESPONDENT TO ROSSMAN

Christopher C. Wheeler
Member of the Firm

Direct Dial 561.995.4702
cwheeler@proskauer.com

April 26, 1999

Mr. Richard Rossman
Lewinter and Rossman
16255 Ventura Blvd., Suite 600
Encino, CA 91436

Re: iviewit, Inc.

Dear Richard:

Under separate cover I have forwarded you a revised Confidentiality Agreement.

As you know we have undertaken representation of iviewit, Inc. ("iviewit") and are helping them coordinate their corporate and intellectual property matters. In that regard, we have reviewed their technology and procured patent counsel for them. We believe the iviewit technology is far superior to anything presently available with which we are familiar. Iviewit has filed a provisional patent application on a method for providing enhanced digital images on telecommunications networks. We are advised by patent counsel that the process appears novel and may be protected by the patent laws. While in all matters of this sort, it is far to early to make any final pronouncements, we do believe that there is an extremely good prospect that iviewit will protect their process which is novel and superior to any other format which we have seen.

Very truly yours,

Christopher C. Wheeler

CCW/gb



LETTER FROM HASSAN MIAH

> -----Original Message-----

> From: eib [SMTP:alps@netline.net]

> Sent: Saturday, May 29, 1999 8:24 PM

> To: hmiah@xingtech.com

> Subject: iviewit, inc.

>

> <?XML:NAMESPACE PREFIX = O />

>

> Hassan,

>

> Have you heard any news from Kevin? Hope all is going well.

>

> Eliot

-----Original Message-----

From: Hassan Miah [mailto:hmiah@xingtech.com]

Sent: Sunday, May 30, 1999 1:19 PM

To: 'eib'

Subject: RE: iviewit, inc.

Not yet. I will work out a meeting time over the next couple of days. I was looking at the profile of Ken Rubinstein at Proskauer, very impressive! Is he the person that reviewed your patent application? Ken appears to be the person behind setting up the MPEG patent pool. Xing is a licensee under this. Do you mind if I e-mail Ken questions about the nature of the patent? Also, I have not heard from Goldman.

This project is very exciting to me. I keep thinking about the possibilities. Hopefully you, Kevin and I can meet over the next couple of weeks so we can accelerate our activities. How are you doing setting up the demo to view over the Internet? My home number is 805-594-0292 if you want to talk.

Hassan



LETTER FROM MR. RUBENSTEIN



PROSKAUER ROSE LLP

1185 Broadway
New York, NY 10036-8299
Telephone 212 969 3000
Fax 212 969 2900

1201 ANSELMI
WASHINGTON DC
BOCA RATON
CLAYTON NJ
PARIS

Kenneth Rubenstein
Member of the Firm
Direct Dial 212 969 3185
krubenstein@proskauer.com

40017.001
Ivickit
GKKKPAK
Call

March 2, 1999

VIA NEXT DAY AIR

Mr. Eliot I. Bernstein
500 S.E. Mizner Blvd.
Suite 102
Boca Raton, Florida 33432-6080

Re: *Ivickit*

Dear Eliot:

I just thought I would send you a few sample patents so you
required by the patent office.

Please contact me if you would like to discuss

Very truly yours,

Kenneth Rubenstein

KR/jw
Enclosures

cc: Christopher C. Wheeler, Esq.
Albert W. Gortz, Esq.

*Patent
file?
Correspondence*

enclosure is

23 2:42 PM



LETTER FROM COMPANY TO MR. RUBENSTEIN

-----Original Message-----

From: Eliot Bernstein [mailto:alps@netline.net]
Sent: Tuesday, [February 23, 1999 7:53 AM](#)
To: Kenneth Rubenstein (E-mail); Christopher C. Wheeler (E-mail)
Subject: Please call when you receive this message. 800.519.0234 or
561.417.8980

[Ken,](#)

[Per our discussion, I have attached the following file = process.doc.](#)

Eliot

<< File: ATT00027.html >> << File: PROCESS.doc >>



PROSKAUER BILLINGS

02/18/99 C WHEELER	.25 Conf with Mr. Rubenstein
01/14/99 C WHEELER	.50 Follow up on status on intellectual property review and new incorporation
01/28/99 A GORTZ	.75 Ken Rubenstein call, cf call Eliot Bernstein & Ken Rubenstein, cf Mara Robbins re confidentiality agreement
02/01/99 C WHEELER	.25 Conf as to status of intellectual property work
02/16/99 C WHEELER	.25 Conf with Mr. Bernstein; call to Mr. Rubenstein
02/17/99 C WHEELER	.25 Call to Mr. Rubenstein re patent advice; call with Ms. Coleman re financial advisor
02/18/99 C WHEELER	.25 Conf with Mr. Rubenstein
03/16/99 M ROBBINS	.50 Inter-office conference with Wheeler re: intellectual property matters.
03/29/99 K HEALY	1.25 Tc w/C. Wheeler; tcs w/Eliot Bernstein re intellectual property protections; tc w/Raymond Joao re patent pending; tcs w/E. Bernstein and Jerry Levin re license business models; review protectability of web-sites
03/31/99 K HEALY	.25 Tc w/K. Rubenstein re Patent advice
04/22/99 K HEALY	.25 Tc w/R. Joao; e-mail to E. Bernstein
05/12/99 C WHEELER	1.00 Conf with Messrs Bernstein and Lewin; call to R. Joao; transmittal of agreement
05/12/99 C WHEELER	.50 Conf with Mr. Joao re stock ownership, subsidiary and patent protection
05/12/99 C WHEELER	2.00 Conf with Joao; meeting with Thompson to arrange for confid. agreements and generic agreements



05/20/99 C WHEELER	.75 Conf with Mr. Joao
05/20/99 C WHEELER	2.00 Call to Mr. Lewin; conf with Ken Rubenstein; conf with Mara Lerner; numerous conf with Elliot Bernstein
05/20/99 C WHEELER	1.00 Conf with Mr. Joao
05/25/99 C WHEELER	11.00 Trip to Orlando for meeting with Real 3D technology staff
05/26/99 C WHEELER	1.00 Review of patent; set up patent conference; arrange follow up on shares;
05/27/99 C WHEELER	.50 Conf with Mr. Rubenstein
05/27/99 C WHEELER	1.50 Overview of Iviewit patent matters and corporate matters
05/28/99 C WHEELER	.50 Confirmation on Joao meeting
05/28/99 C WHEELER	2.00 Meeting as to patent issues and management matters
05/28/99 C WHEELER	.50 Conf. w/K.Rubenstein
05/28/99 K HEALY	.50 Tcs w/C. Wheeler re IP Issues; review web-site
05/31/99 C WHEELER	1.00 Review of patent and other materials
06/01/99 C WHEELER	4.00 Conf with Mr. Rubenstein; conf with Mr. Lewin; conf with Mr. Healy; conf with Mr. Joao; conf with Mr. Akselrod re patents, tax ramifications, copyright work;
06/01/99 K HEALY	1.50 Conference call w/E. Bernstein, R. Joao, K. Rubenstein, C. Wheeler, and others re iviewit I.P. issues; review cd.rom
06/03/99 C WHEELER	2.00 Call to Mr. Joao; call to Mr. Healy; conf with Mr. Bernstein; review of numerous correspondence; conf with Mr. Lewin
06/04/99 C WHEELER	2.00 Prep of revised confidentiality agreement; call to Ms. Bibona; conf with Mr. Joao;
06/11/99 C WHEELER	.25 Call to R.Joao



06/16/99 C WHEELER 4.00 Meeting with Mr. Joao and Messrs. Bernstein re patent and other matters

06/23/99 S KAPP .50 Conf. with CCW regarding various matters pertaining to structure, patents, confidentiality agreements

06/18/99 C WHEELER 3.50 Review of patents with Mr. Joao; conf with Mr. Lewin re status; conf with Mr. Bernstein; Check of status of new corporate documents

06/23/99 S KAPP .50 Conf. with CCW regarding various matters pertaining to structure, patents, confidentiality agreements

07/28/99 C WHEELER 3.50 Conf with Mr. Lewin; conf with Mr. Buchsbaum; review of corporate status; conf with Mr. Thompson; review of corres. from Mr. Epstein; call to Mr. Joao; conf with Mr. Wilson; conf with Mr. Joao; call to Mr. Lewin

07/31/99 C WHEELER 1.50 Review and organization of various matters involving meetings, venture capital, patents and prospects

08/04/99 S KAPP .25 T/c with Ray Joao

09/09/99 K HEALY .50 Review files to prepare IP Materials for E. Bernstein and B. Utley

09/10/99 C WHEELER .25 Arrange for patents

09/10/99 C WHEELER 2.00 Conf with Mr. Brandon; conf with Mr. Brandon; conf with Mr. Rubenstein; transmittal of materials to Mr. Rubenstein; Call to Mr. Joao

09/13/99 C WHEELER 1.00 Conf with Mr. Brandon; conf with Mr. Joao;

09/13/99 J ZAMMAS 1.25 Discuss patents with C. Wheeler's secretary;

09/21/99 C WHEELER .25 Call to Mr. Utley re patent meeting

09/21/99 C WHEELER 1.00 Conf with Mr. Utley re patent meeting and status of negotiations; call to Mr. Brandon



09/22/99 J ZAMMAS 3.00 Work on patent binders and trademark binders for C. Wheeler; telephone Raymond Joao regarding all patents; compile all documents by shareholder/noteholder

09/23/99 J ZAMMAS .25 Telephone Raymond Joao regarding patents.

09/24/99 C WHEELER 1.00 Call on utilities; follow up on space requirements; conf on patent questions

09/24/99 J ZAMMAS .50 Update shareholder list; telephone Raymond Joao's secretary regarding patents; advise C. Wheeler.

09/27/99 J ZAMMAS 2.50 Revise consents to indicate that Brian Utley is elected as Chief Operating Officer of the three entities; telephone calls from Mr. Joao's office regarding patents; complete work on patent binders for C. Wheeler; send stock certificate of uview.com, Inc. to Patricia Daniels; send iviewit.com LLC subscription letters to James Armstrong, Andrew Dietz, Lisa Friedstein and James Osterling.

11/29/99 J ZAMMAS .25 Copy official filing receipts for two patents, insert in patent binders and give two copies to Brian Utley to insert in his binders.

01/11/00 C WHEELER 1.00 Conf with Mr. Bernstein re patents and infringement

01/11/00 C WHEELER 1.00 Conf with Mr. Joao re patents

01/11/00 C WHEELER .50 Conf with Mr. Lewin re patents

10/11/00 C WHEELER 1.50 Conf with Mr. Utley re Ken Rubenstein and Time Warner; conf with Mr. Rubenstein



EXHIBIT F



DEPOSITION OF RESPONDENT

1 A. Well, I reviewed what I had. We came
2 back -- If you noticed, we went on the trip on 5/25.
3 At that meeting, for the first time, Eliot displayed
4 to all of us a new product. A video product. And I
5 was driving with his - with his father and with Jerry
6 Lewin in one car and Eliot was in another car, and as
7 we were driving back I said - I asked the question, I
8 said, this new product, is this - what have you done
9 on the patent on this? And Eliot told us all - he was
10 on the phone, he was in another car - he told us all
11 that they hadn't done any work on that yet.

12 So what I did was, I - Eliot had - as he
13 had the patents, he wanted us to lock them up, so I
14 had them locked up. So I pulled - when we returned, I
15 pulled up the locked up patents out to make sure I had
16 them. So I was reviewing them, and we determined we
17 were going to have to set up a conference to make sure
18 he was covered with Joao and everybody to see what to
19 do in view of this new development.



Eliot I. Bernstein

Subject: FW:
Importance: High
Sensitivity: Confidential

-----Original Message-----

From: EIB [mailto:alps1@bellsouth.net] **On Behalf Of** iviewit, inc. (E-mail)

Sent: Tuesday, May 04, 1999 7:29 AM

To: James F. Armstrong (E-mail); Simon L. Bernstein (E-mail); Andrew R. Dietz (E-mail); Donna Dietz (E-mail); Theodore D. Lanzaro (E-mail); Guy Iantoni (E-mail); James A. Osterling (E-mail); Kevin J. Healy (E-mail); Christopher C. Wheeler (E-mail); Jude Rosario (E-mail)

Subject: Business plan revisions

 **iviewit** intends to establish itself as a global leader in virtual multimedia display by licensing its patented virtual imaging and streaming video technologies as well as utilizing these proprietary technologies to build an e-commerce portal with production values exceeding those of any existing portals. **iviewit** will generate revenues from the licensing of proprietary technologies, strategic e-commerce revenue sharing agreements, strategic advertising agreements, and by establishing an image and video production capability. In the **iviewit** web site, products are represented in a high definition virtual reality environment where the end user can control and manipulate the product environment to view multifaceted dimensions with high-

 powered magnification. **iviewit** video technology enables the user to see TV quality full motion and full screen Internet video without the standard grainy picture and lengthy download times. Simply put, **iviewit** technology redefines the quality of the virtual viewing experience.



EXHIBIT G



Atty. Dkt. No. 57103/123

U.S. PROVISIONAL PATENT APPLICATION

for

**ZOOM AND PAN IMAGING
DESIGN TOOL**

Inventors:

Brian G. Utley
1930 SW 8th Street
Boca Raton, FLORIDA 33486
Citizenship: U.S.

FOLEY & LARDNER
Attorneys at Law
777 E. Wisconsin Avenue
Milwaukee, Wisconsin 53202
(414) 271-2400



EXHIBIT H



BLAKELY SOKOLOFF TAYLOR & ZAFMAN LLP

A LIMITED LIABILITY PARTNERSHIP
INCLUDING LAW CORPORATIONS

TELEPHONE (310) 207-3800

FACSIMILE (310) 820-5988
(310) 820-5270

BSTZ_MAIL@BSTZ.COM
WWW.BSTZ.COM

INTELLECTUAL PROPERTY LAW

12400 WILSHIRE BOULEVARD
SEVENTH FLOOR
LOS ANGELES, CA 90025-1026

OTHER OFFICES

AUSTIN, TX
SUNNYVALE, CA
COSTA MESA, CA
SAN DIEGO / LA JOLLA, CA
PORTLAND / LAKE OSWEGO, OR
SEATTLE / KIRKLAND, WA
DENVER / ENGLEWOOD, CO

August 4, 2001

**Confirmation
Copy**

**CONFIDENTIAL COMMUNICATION
ATTORNEY-CLIENT PRIVILEGED**

VIA E-MAIL
(And Confirmation By Mail)

Eliot Bernstein
IVIEWIT.COM, INC.
505 North Brand Boulevard, Suite 1420
Glendale, California 91203

Re: Powers of Attorney for Six PCT Applications:

Apparatus and Method for Producing Enhanced Digital Images Serial No. PCT/US00/07772 Our File No. 005707.P009PCT Foley's Reference No. 110	System and Method for Playing a Digital Video File Serial No. PCT/US00/15406 Our File No. 005707.P012PCT Foley's Reference No. 113
System and Method for Streaming an Enhanced Digital Video File Serial No. PCT/US00/15408 Our File No. 005707.P010PCT Foley's Reference No. 111	System and Method for Video Playback Over a Network Serial No. PCT/US00/15602 Our File No. 005707.P016PCT Foley's Reference No. 118
System and Method for Providing an Enhanced Digital Video File Serial No. PCT/US00/15405 Our File No. 005707.P011PCT Foley's Reference No. 112	System and Method for Providing an Enhanced Digital Image File Serial No. PCT/US00/21211 Our File No. 005707.P018PCT Foley's Reference No. 120

Dear Eliot:

Being e-mailed (and enclosed herewith) are six (6) Powers of Attorney for the subject PCT Patent Applications, one Power for each inventor named in any one or more of the PCT patent applications, and one Power for the corporation, Iviewit Holdings, Inc. Three of the Powers require your signature, as follows: (i) one by you in your individual capacity; (ii) a second by you in your capacity as designee of the corporation to sign on behalf of Brian Utley (we hope the PCT Office will recognize Utley's having granted a Power of Attorney to his corporate employer); and (iii) a third by you for the corporation in your capacity as its Secretary. Kindly sign where your



BLAKELY SOKOLOFF TAYLOR & ZAFMAN LLP

A LIMITED LIABILITY PARTNERSHIP
INCLUDING LAW CORPORATIONS

Eliot Bernstein
IVIEWIT.COM, INC.
August 4, 2001
Page 2 of 2

signature is indicated on the three Powers of Attorney and return the original executed Powers to our office via mail (we need to have each Power with an original signature). Also fax each Power to us at (310) 820-5988, to expedite the process.

As we discussed, we request that you also forward each of the three remaining Powers to Jude R. Rosario, Jeffrey S. Friedstein and Zakirul A. Shirajee, respectively, for their signatures. Kindly instruct each of them to execute the Powers and to return the originals to our office by mail. In order to expedite the matter, request each of them to fax a copy to us, if possible.

If you have any questions, please feel free to contact my Assistant, Jan Gass. We appreciate your attention to getting the subject Powers executed and returned to us. We will then attend to their filing with the PCT Office.

Best personal regards,

BLAKELY, SOKOLOFF, TAYLOR & ZAFMAN, LLP

Digitized Signature

Norman Zafman

NZ/jg
Enclosures

cc: Ross Miller (w/Enclosures via E-Mail) ✓

P.S. to Ross Miller:

Ross, please attend to getting a Board Resolution appointing Eliot as the corporation's designee for signing the subject Power on behalf of Brian Utley. We talked about this in the context of giving Eliot comfort; however, the PCT Office may well request such a Resolution (in addition to a copy of Utley's Employment Agreement, which we already have).



EXHIBIT I



LETTER FROM MR. COLTER

-----Original Message-----

From: David.Colter@warnerbros.com [mailto:David.Colter@warnerbros.com]
Sent: Wednesday, August 01, 2001 10:28 PM
To: HeidiKrauel@aol.com
Cc: HPowell@cb-ventures.com; Eliot@iviewit.com
Subject: Re: Today -- iviewit

Heidi,

Here is the info for Hank Powell from Crossbow Ventures. I have copied him above to make the introduction.

iviewit has undergone a restructuring of their business from an encoding focused business to a technology licensing business focus over the past 4-5 months. They are in the process of establishing a new executive team to handle this 'new' direction and have been working on the new business plan. They have indicated that we should have the revised plan next week.

They currently are finalizing a contract with WB Online to provide encoding services as a hold over from our original collaboration, and as a showcase for the technologies and patents.

Their site www.iviewit.com contains good demonstrations of the zooming and video encoding technologies. I have also copied the inventor/founder Eliot Bernstein, who I will ask to provide some specific links on the site to see the best representation of their work and technical capabilities.

Their patents are pending, but have received favorable opinions from people such as Ken Rubenstein on the merit of the patents, as well as thorough review by Greg Thagard and myself.

Let's talk further after you see the business plan and connect with Hank.

Thanx,
David



**LETTER OF MR. UTLEY LETTER ADVISING OF RUBENSTEIN'S ACTIVITY
AS ADVISORY BOARD MEMBER**

From: Brian G. Utley [brian@iviewit.com]
Sent: Wednesday, April 18, 2001 8:17 AM
To: Eliot I. Bernstein; 'simon@adelphia.net'; 'kanderson@myCFO.com'; 'dg_kane@msn.com'; 'glewin@goldsteinlewin.com'; 'hankpow@gate.net'; 'bprolow@tiedemannfunds.com'; Maurice Buchsbaum
Cc: 'Christopher C. Wheeler (E-mail)'
Subject: RE: Minutes of the Board Meeting of April 14, 2001

I was advised by Proskauer Rose that anyone who was in an active due diligence stage and who was reviewing our intellectual property as part of that due diligence should receive a copy of the examiners opinion. Therefore the opinion was forwarded to the same people who have received copies of the patent filings namely, Warner Brothers and Irell & Manella. Ken Rubenstein, as our advisor, was also copied. Your father suggested that, because of the importance of our intellectual property, our own Board of Directors should be aware of the current status of our applications. With respect to Irell & Manella, it is quite likely that we will need to engage them or some other alternative counsel in order to respond to the opinion. I have a copy of Alvear's book if you need it.

With respect to processing the requested demo tape, you may recall that you actually set the standard by processing similar demo material for igallery some time ago. This job was handled discreetly and the 18 year old employee referred to had already been released from the business. We are not in the business of processing adult entertainment material and have consistently represented this position. I trust this clarifies both matters.
Brian



DECEMBER 2000 PRIVATE PLACEMENT MEMORANDUM FOR WACHOVIA SECURITIES

Advisors

Alan J. Epstein

Partner, Armstrong Hirsch Jackoway Tyerman & Wertheimer, P.C.

Mr. Epstein's law practice consists of advising Internet companies on various issues pertaining to the entertainment and sports industries, including the creation, licensing and acquisition of content, the introduction and negotiation of strategic partner relationships, and various other matters relating to the convergence of technology and content. Mr. Epstein also advises his firm's numerous celebrity clients on the exploitation and protection of their name and likeness rights and content on the Internet, as well as merchandising, endorsement and sponsorship deals. Prior to entering the UCLA School of Law, Mr. Epstein was a certified public accountant at Deloitte Haskins & Sells in Dallas, Texas.

Kenneth Rubenstein

Partner, Proskauer Rose LLP

Mr. Rubenstein is a partner at Proskauer Rose LLP law firm and is the patent attorney for iviewit. He is a registered patent attorney before the U.S. Patent & Trademark Office. Mr. Rubenstein counsels his clients with respect to the validity and infringement of competitors' patents, as well as prosecutes patent applications. For the past several years he has worked on the formation of a patent pool, for MPEG-2 technology, involving large consumer electronics and entertainment companies. He is also a former member of the legal staff at Bell Laboratories. Mr. Rubenstein received his law degree, cum laude, from New York Law School, and his Ph.D. in physics from the Massachusetts Institute of Technology where he also graduated with a B.S. Degree.

Christopher C. Wheeler

Partner, Proskauer Rose LLP

Mr. Wheeler is a member of Proskauer Rose LLP's Corporate Department and as a partner in the Florida office has a versatile transactional practice. He has had extensive experience in real estate and corporate law, institutional lending and workouts, administrative law and industrial revenue bond financing. Moreover, he serves as a strategist and counselor to many clients in handling their other legal and business matters. Mr. Wheeler is well-versed in general corporate law as well as mergers and acquisitions and securities matters. He has guided companies from startup through initial private placements to public offerings. A graduate of Hamilton College and Cornell Law School, Mr. Wheeler was a member of the managing Board of Editor of the Cornell Law Review.



Company has retained Foley & Lardner to shepherd its patent development and procurement. In addition, the Company has retained Kenneth Rubenstein of Proskauer Rose, LLP to oversee its entire patent portfolio – Mr. Rubenstein is the head of the MPEG-2 patent pool.

iviewit has assembled a complementary and seasoned, management team with executive rank, Fortune 100 and early-stage, entrepreneurial experience. The Company has retained Korn / Ferry to assist in the identification and recruitment of a high impact Chief Executive Officer (preferably from the media or entertainment industry) and an experienced Chief Technical Officer.

Since its June 1999 inception, the Company has raised over \$4.3 million of venture capital from Crossbow Ventures, Huizenga Holdings, and individual investors.

Management

Whereas the Company has retained Korn / Ferry to assist in the identification and recruitment of a high impact Chief Executive Officer (preferably from the media or entertainment industry) and Chief Technical Officer, iviewit has assembled a complementary and seasoned, management team with Fortune 100 and early-stage, entrepreneurial experience. This team consists of the following personnel:

Brian G. Utley, President (67) — For over 30 years, Mr. Utley was responsible for the development and world-wide management of many of IBM's most successful products such as the AS400 and the PC. His career with IBM culminated with his responsibility as Vice President and General Manager of IBM Boca Raton with a work force of over 6,000 professionals. He is a graduate of San Francisco City College.



DEPOSITION OF MR. UTLEY

(11) Q. In New York. Okay. Now, going back
(12) to something that Mr. Prusaski started but I
(13) don't think he completed with was some of your
(14) background information about your education. If
(15) you can just tell me from undergraduate onward
(16) what your educational background is, Sir, schools
(17) you attended, years of attendance and degree.

(18) A. I don't have a degree.

(19) Q. Okay.

(20) A. I attended Weaver State University,
(21) which was then Weaver College, 1950.

(22) Q. Okay.

(23) A. San Francisco City College, 1957,
(24) 1958.

(25) Q. Okay. And you graduated from San

(1) Francisco College or did not?

(2) A. I don't have a degree.

(3) Q. Okay. So you never completed your
(4) course at San Francisco then?

(5) A. Right.



DEPOSITION OF MR. RUBENSTEIN

2 Q. Do you have any information at all
3 with regard to any of the IViewIt entities?

4 A. Not at this time, no.

5 Q. "Not at this time." Did you have
6 any information at any time in the past, sir?

7 A. Not that I know of right now.

8 Q. Do you have any files or records
9 indicating that you had any dealings with --
10 and I will go through a list here --

11 IViewIt.com, Inc.?

12 A. Not that I know of.

13 Q. IViewIt, LLC?

14 A. Not that I know of.

15 Q. UViewIt?

16 A. Not that I know of.

17 Q. IViewIt, Inc.?

18 A. Not that I know of.

19 Q. Have you ever heard of an
20 individual named Eliot Bernstein?

21 A. I might have.

22 Q. Well, sir, that's either a "Yes"
23 or "No" question.

24 A. Like I said, I think he works for
25 IViewIt, and I may have heard his name.



2 Q. How about what is called the MPEG
3 Patent Pool, have you heard of that?

4 A. Yes, I have.

5 Q. why don't you tell me what that
6 is.

7 A. Decline to answer at this time.

8 Q. why do you decline to answer?

9 A. Irrelevant to this deposition.

10 Q. I'm sorry, irrelevancy is not an
11 objection that would allow you not to answer,
12 sir.

13 A. Make a motion to the judge. If he
14 orders me to tell you about it, I will tell
15 you.

1

2

3 IN THE CIRCUIT COURT OF THE
4 15th JUDICIAL CIRCUIT IN AND
5 FOR PALM BEACH COUNTY, FLORIDA

6 -----X

7 PROSKAUER ROSE L.L.P.,

8 Plaintiff,

9 vs. CA 01-04671 AB

10 IVIEWIT.COM, INC., a Delaware
11 corporation, IVIEWIT HOLDINGS,
12 INC., a Delaware corporation,
13 and IVIEWIT TECHNOLOGIES,
14 INC., a Delaware corporation,

15 Defendants.

16 -----X

17

18

19

20 DEPOSITION OF KENNETH RUBENSTEIN

21 New York, New York

22 Wednesday, November 20, 2002

23

24

25

26 Reported by:
27 WENDY D. BOSKIND, RPR
28 Job No. 142586

29

□

Ken Rubenstein Deposition

2
3
4
5
6
7
8
9
10
11
12
13
14
15
16
17
18
19
20
21
22
23
24
25

November 20, 2002
11:06 a.m.

Deposition of KENNETH RUBENSTEIN,
held at the offices of Proskauer Rose
LLP, 1585 Broadway, New York, New York,
pursuant to Notice and Agreement,
telephonically pursuant to a Court
Order, before Wendy D. Boskind, a
Registered Professional Reporter and
Notary Public of the State of New York.

□

3

1
2
3
4

A P P E A R A N C E S :

PROSKAUER ROSE LLP

5 Ken Rubenstein Deposition
Attorneys for Plaintiff
6 2255 Glades Road
7 Suite 340 West
8 Boca Raton, Florida 33431-7360
9 BY: CHRISTOPHER W. PRUSASKI, ESQ.

10
11
12 SELZ & MUVDI SELZ, P.A.
13 Attorneys for Defendants
14 214 Brazilian Avenue
15 Suite 220
16 Palm Beach, Florida 33480
17 BY: STEVEN M. SELZ, ESQ.
18 (telephonically)

19
20
21 ALSO PRESENT:
22 ELIOT BERNSTEIN, ESQ.
23 (telephonically)

24
25
1
2 K E N N E T H R U B E N S T E I N ,
3 business address at Proskauer Rose
4 LLP, 1585 Broadway, New York, New York,
5 having first affirmed before the Notary
6 Public, (Wendy D. Boskind), was examined
7 and testified as follows:

□

Ken Rubenstein Deposition

8

9 EXAMINATION BY

10 MR. SELZ:

11 Q. Mr. Rubenstein, my name is
12 Attorney Steve Selz, I represent the
13 Defendants in the case of Proskauer Rose
14 versus IViewIt.com.

15 I am going to ask you a series of
16 questions in this deposition, and the first
17 thing I need to know is whether or not you
18 have had your deposition taken previously.

19 A. I have had my deposition taken
20 previously.

21 Q. On how many occasions has that
22 taken place, sir?

23 A. Several.

24 Q. "Several", more than a dozen?

25 A. No.

□

5

1 Rubenstein

2 Q. More than five?

3 A. No.

4 Q. Can you give me an approximate
5 number? Two or three?

6 A. I would say three or four.

7 Q. Okay, three or four. So you are
8 familiar with the way a deposition works; is
9 that correct, sir?

10 A. Yes.

11 Q. So if I ask you a question, unless
12 you ask me to rephrase it or somehow revise
13 the structure of the question, I will presume
14 then that you have understood what I have
15 asked you as it is posed.

16 A. If I think your question is of
17 improper form, unclear, or harassment, I am
18 going to object.

19 Q. Okay, I believe that would be not
20 for you to do but Mr. Prusaski, as your
21 counsel.

22 A. I will put any objection I want on
23 the record, in addition to Mr. Prusaski.

24 Q. So, you are representing yourself?

25 A. No, I am not, he is representing

□

6

1 Rubenstein
2 me, but I am going to put objections on the
3 record, if I want to.

4 Q. That's fine.

5 Now, starting off with, sir, could
6 you please state your full name?

7 A. Kenneth Rubenstein.

8 Q. "Kenneth Rubenstein." And where
9 is your place of employment currently,
10 Mr. Rubenstein?

11 A. Proskauer Rose.

12 Q. Where is that located?

13 A. 1585 Broadway, New York.

14 Q. And how long have you been
15 employed with Proskauer Rose?
16 A. About four, four-and-a-half years.
17 Q. Somewhere between 1997 and 1998
18 was your first date of employment?
19 A. I think it was in 1998.
20 Q. Do you remember a month?
21 A. Possibly June.
22 Q. June. Where were you employed
23 prior to your employment with Proskauer Rose?
24 A. I was with a law firm, Meltzer,
25 M-E-L-T-Z-E-R, Lippe, L-I-P-P-E.

□

7

1 Rubenstein
2 Q. Meltzer Lippe is located where?
3 A. Mineola, New York.
4 Q. Do you have an address that you
5 can recall?
6 A. On Willis Avenue, but I don't have
7 the address right now.
8 Q. Prior to Meltzer Lippe -- and
9 approximately what were the dates of your
10 employment at Meltzer Lippe?
11 A. About 1993 to 1998.
12 Q. And what did you do at Meltzer
13 Lippe?
14 A. I was an attorney.
15 Q. Did you have any specialization?
16 A. I was a patent attorney.

- 17 Q. Are you still a patent attorney?
18 A. Yes.
19 Q. Is that your role at Proskauer
20 Rose currently, is a patent attorney?
21 A. Yes.
22 Q. Are you a partner of Proskauer
23 Rose?
24 A. Yes.
25 Q. Are you a shareholder of Proskauer

□

8

- 1 Rubenstein
2 Rose?
3 A. One or the other, either partner
4 or shareholder.
5 I think it's a partnership.
6 Q. It's a partnership. Do you have
7 any ownership interest in the partnership in
8 the sense of obligations that go beyond what
9 some of the other partners have? In other
10 words, do you have an equity share? Do you
11 have any other claims with regard to an
12 interest in Proskauer Rose?
13 A. I have no idea.
14 Q. Prior to Meltzer Lippe, where were
15 you employed, sir?
16 A. Another law firm.
17 Q. Do you remember the name of that
18 law firm?
19 A. Marmorek, M-A-R-M-O-R-E-K,

Ken Rubenstein Deposition
20 Guttman, G-U-T-T-M-A-N, & Rubenstein.

21 Q. Were you the "Rubenstein" in the
22 name of the firm?

23 A. Yes.

24 Q. And you were a partner in that
25 firm?

9

1 Rubenstein

2 A. Yes.

3 Q. What were the dates of your
4 employment in that firm --

5 A. Oh --

6 Q. -- Marmorek Guttman & Rubenstein.

7 A. -- probably starting in the
8 Eighties, mid-Eighties, until 1993.

9 Q. And what was the area of your
10 practice, when you were with Marmorek --

11 A. M-A-R-M-O-R-E-K.

12 Patent law.

13 Q. Patent law. And your dates -- you
14 say you left Marmorek Guttman & Rubenstein and
15 went to Meltzer Lippe and then to Proskauer
16 Rose, but at all times you were a patent
17 lawyer --

18 A. Yes.

19 Q. -- is that a correct statement?

20 A. Yes.

21 Q. Is that a correct statement, sir?

22 A. Yes.

23 Q. You have to wait until I finish
Page 8

Ken Rubenstein Deposition

24 the question.

25 A. No, you are not getting the

□

10

1 Rubenstein

2 answers clearly in your head. You should take
3 better notes.

4 MR. SELZ: Move to strike as
5 non-responsive.

6 (MOTION TO STRIKE.)

7 A. That's fine, move to strike it.

8 Q. Sir, during that entire period of
9 time, then, you were a patent lawyer; is that
10 a correct statement of fact?

11 A. Yes.

12 Q. Are you familiar with something
13 that's called "pan and zoom technology"?

14 A. I am not sure what you mean by
15 that.

16 Q. Well, let me start very simply,
17 and say this. Are you familiar with a concept
18 that an image can be enlarged while being
19 transmitted on a narrow bandwidth?

20 A. I don't know what you are talking
21 about.

22 Q. Okay. Well, let me go back to
23 this, then, sir. Are you familiar at all with
24 the technology involved with IViewIt.com?

25 A. No.

1 Rubenstein

2 Q. Do you have any information at all
3 with regard to any of the IViewIt entities?

4 A. Not at this time, no.

5 Q. "Not at this time." Did you have
6 any information at any time in the past, sir?

7 A. Not that I know of right now.

8 Q. Do you have any files or records
9 indicating that you had any dealings with --
10 and I will go through a list here --
11 IViewIt.com, Inc.?

12 A. Not that I know of.

13 Q. IViewIt, LLC?

14 A. Not that I know of.

15 Q. UViewIt?

16 A. Not that I know of.

17 Q. IViewIt, Inc.?

18 A. Not that I know of.

19 Q. Have you ever heard of an
20 individual named Eliot Bernstein?

21 A. I might have.

22 Q. Well, sir, that's either a "Yes"
23 or "No" question.

24 A. Like I said, I think he works for
25 IViewIt, and I may have heard his name.

Ken Rubenstein Deposition
Rubenstein

1

2 Q. How about what is called the MPEG
3 Patent Pool, have you heard of that?

4 A. Yes, I have.

5 Q. Why don't you tell me what that
6 is.

7 A. Decline to answer at this time.

8 Q. Why do you decline to answer?

9 A. Irrelevant to this deposition.

10 Q. I'm sorry, irrelevancy is not an
11 objection that would allow you not to answer,
12 sir.

13 A. Make a motion to the judge. If he
14 orders me to tell you about it, I will tell
15 you.

16 MR. SELZ: Chris, are you
17 instructing your client not to answer?

18 MR. PRUSASKI: I am going to put
19 an question for relevancy based on the
20 court's granting of the motion and
21 limiting on the record, and if
22 Mr. Rubenstein declines to answer then
23 he is declining to answer.

24 And, just so I don't have to keep
25 objecting, Mr. Selz, to make this

□

13

1

Rubenstein

2 easier, my objection is continuing in
3 nature as to any questions regarding any

4 Ken Rubenstein Deposition
5 transactions for IViewIt that you are
6 going to ask Mr. Rubenstein if he was
7 involved in based on the court's
8 granting of the motion and limiting.

8 MR. SELZ: Let me go on the record
9 and say the discovery documents that
10 have been produced by the Defendants --
11 Plaintiff in this matter indicate
12 various dealings in which Proskauer Rose
13 was affiliated including dealings with
14 H. Wayne Huizenga, CrossBow Ventures,
15 Wachovia, a number of other entities
16 which are part of the discovery and have
17 been produced by the Plaintiffs pursuant
18 to a valid request for production, so to
19 the extent you are claiming it's subject
20 to any motion and limited, that's fine
21 with regard to the trial, and the
22 discovery you produced on your own
23 pursuant to a request for production
24 which has not been held invalid includes
25 these very matters.

□

14

1 Rubenstein
2 A. So why don't you tell me more
3 particularly what you want to know.

4 MR. PRUSASKI: Mr. Selz, let me
5 just respond to that.

6 There were never any affirmative

7 Ken Rubenstein Deposition
8 defenses asserted by the Defendants in
9 this matter that have anything to do
10 with particular transactions, the
11 defenses involved whether the bills
12 were --

13 MR. SELZ: Let's go --

14 MR. PRUSASKI: I get to finish
15 because --

16 MR. SELZ: Go ahead and finish.

17 MR. PRUSASKI: Thank you.

18 There were never any affirmative
19 defenses asserted by the Defendants in
20 this matter relating to anything other
21 than the amount of the bills. And, so,
22 to the extent that the court granted our
23 motion limiting it, the Defendants can't
24 put any evidence of any particular
25 transactions or alleged wrongdoing by
Proskauer on at trial, but to that

□

15

1 Rubenstein
2 extent I am going to ask Mr. Rubenstein
3 to answer your questions. If I feel
4 that they are becoming overreaching, I
5 will make -- or if you are extending too
6 far into what I think is a violation of
7 the court's granting of the motion of
8 limiting, I will make another objection.

9 MR. SELZ: And let me go on the

10 Ken Rubenstein Deposition
11 record, the motion of limiting is fine
12 with regard to anything presented at
13 trial. It certainly does not preclude
14 the scope of discovery from including,
15 in a deposition, questions which may
16 lead to discoverable evidence concerning
17 the bills and the services that were
18 provided, which is the basis for the
19 affirmative defenses.

19 MR. PRUSASKI: And I am aware that
20 you have some latitude with respect to
21 discovery under the rules.

22 MR. SELZ: And I think we have
23 pretty significant latitude under the
24 rules.

25 And with regard to your client,

□

16

1 Rubenstein
2 Mr. Rubenstein, indicating he is
3 refusing to answer, I believe you should
4 instruct him right now, under Florida
5 law, he doesn't have the right to refuse
6 to answer.

7 A. All right, I will answer the
8 question.

9 MR. PRUSASKI: I just said a
10 minute ago we will go ahead.

11 A. Anything you want to know about
12 the MPEGLA patent pool, that's public

13 information, it's is on a web site,
14 MPEGLA.com. You should go look at that
15 web site. Any public information that I am
16 entitled to tell you is on that web site.

17 Q. Well, I am going to ask you, sir,
18 in this deposition to give me that
19 information.

20 A. And I am just telling you to go
21 look at the web site.

22 MR. SELZ: Let the record show the
23 witness is refusing to respond to a
24 direct question.

25 A. That is an incorrect

□

17

1 Rubenstein
2 characterization of the record.

3 The record shows that I told you a
4 place where you can get the answer very
5 easily. There is no reason for you to make me
6 sit here and waste my time repeating to you
7 things you can easily read about.

8 Q. Well, sir, this is your testimony
9 at your deposition.

10 A. That's right, which you are making
11 me do. I consider the deposition nothing but
12 harassment, considering that I had nothing to
13 do with the company. It's just a form of
14 harassment.

15 You go read the web site, if you

16 want to know about it.

17 Q. Okay, so you are refusing to
18 answer?

19 A. I am not refusing.

20 Q. Other than advising me to go to a
21 web site --

22 A. I am not refusing to answer. I
23 did answer. Please stop characterizing my
24 testimony. I told you the answer. I told you
25 all publicly-available information about the

□

18

1 Rubenstein

2 MPEG patent pool can be found at
3 www.MPEGLA.com. You are free to go read it.
4 Please go read it and you will learn all you
5 need to know about it.

6 Q. So you are not going to tell me
7 what the "MPEG patent pool" is?

8 A. I told you you could go read it.

9 Q. Okay.

10 MR. SELZ: Chris, do you want to
11 instruct your witness, or deponent, or
12 client, at all in that matter?

13 MR. PRUSASKI: Do you have any
14 specific questions with respect to
15 IViewIt in the MPEG patent pool?

16 MR. SELZ: Yes.

17 A. All right, so why don't you ask me
18 those questions.

19 MR. SELZ: I want Mr. Rubenstein
20 to first explain to me what the "MPEG
21 patent pool" is, and then I will ask him
22 questions concerning exactly how it
23 relates to IViewIt.
24 In other words --
25 A. Okay, I will answer both your

□

19

1 Rubenstein
2 questions.
3 Q. Go ahead.
4 A. The "MPEG patent pool" is a
5 collection of patents owned by a group of
6 companies related to the MPEG 2 video
7 compression standard and, as far as I know, it
8 has nothing whatsoever to do with IViewIt.
9 Q. So it has no technology -- the
10 MPEG patent pool uses no technology in any way
11 related to any of the IViewIt entities or
12 their intellectual properties; is that your
13 testimony?
14 A. No, it's not my testimony.
15 Q. Okay.
16 A. My testimony is, it's a group of
17 patents chosen according to very specific
18 criteria related to the MPEG 2 standard and,
19 to my knowledge, has nothing to do with
20 IViewIt.
21 And please do not characterize my

22 words. Please do not rephrase them. If you
23 don't know what I said, you can ask the
24 reporter to read it back. But do not
25 characterize my testimony.

□

20

1 Rubenstein

2 MR. SELZ: Again, let the record
3 reflect the deponent is not being
4 responsive.

5 A. I am being very responsive.
6 Please stop characterizing my testimony. And
7 please stop putting things on the record that
8 are incorrect.

9 Q. Mr. Rubenstein, I am asking you
10 questions, and I am asking --

11 A. And you are not listening to the
12 answers very carefully, so -- I don't know how
13 much experience you have taking depositions --

14 MR. SELZ: Again, let the record
15 reflect that --

16 A. Stop interrupting my answers. Do
17 not interrupt me.

18 Q. Mr. --

19 A. Do not interrupt me.

20 Q. Mr. Rubenstein --

21 A. Let me finish.

22 Are you going to proceed to
23 continue to interrupt me or not?

24 Q. If you want to answer the

Ken Rubenstein Deposition
25 questions, I have no problem.

□

21

1 Rubenstein

2 A. Look, I answered your questions.

3 You are unable to keep track of what I am

4 saying.

5 So, please, if you don't know what

6 I said, ask the reporter to read it back, but

7 please do not characterize my testimony in

8 your own words.

9 Q. Okay --

10 A. Just don't do it.

11 Q. What I am asking you is this. Do
12 any of the members of the MPEG patent pool use
13 any of the technologies of IViewIt?

14 A. I would have no idea.

15 Q. Who is the person in charge of the
16 MPEG patent pool, sir?

17 A. Like I say, I advise you to check
18 their web site if you want to know information
19 about that patent pool.

20 Q. Well, again --

21 A. It's not me.

22 Q. Are you involved with the MPEG
23 patent pool, sir?

24 A. Yes.

25 Q. What is your position --

□

22

Ken Rubenstein Deposition

1 Rubenstein

2 A. I am counsel to MPEG, LLC.

3 Q. Do you advise the MPEG patent pool
4 with regard to legal issues?

5 A. That's privileged information.

6 Q. Not whether or not you advised
7 them on legal issues.

8 A. You are asking me -- I am not
9 going to discuss with you anything about
10 anything I do with any other client in this
11 law firm.

12 Q. Well, sir, I am not asking you the
13 substance of what you have advised them, I am
14 simply asking you whether or not you advised
15 them.

16 A. I told you, I am their counsel.

17 Q. Okay. Have you ever seen any of
18 the intellectual properties or technologies
19 that IViewIt has developed for scaled video?

20 A. Not that I recall at this time.

21 Q. Were you ever involved in any
22 patent applications for scaled video
23 technologies for IViewIt.com?

24 A. No.

25 Q. Did you ever review any patent

□

23

1 Rubenstein

2 application at all for IViewIt --
Page 20

Ken Rubenstein Deposition

3 A. Not that I recall.

4 Q. Did you ever opine with regard to
5 the validity of any patent applied for or
6 received by IViewIt.com?

7 A. Like I say, I was not in any way
8 involved with getting patents for IViewIt.

9 Q. What were you involved with, if
10 you were, with IViewIt?

11 A. The only thing I did for IViewIt
12 is I referred them to another patent lawyer.

13 Q. And who is that?

14 A. A guy named Ray Joao.

15 Q. And where did Mr. Joao work?

16 A. I believe he was working at the
17 time at my former law firm, Meltzer Lippe.

18 Q. And what date was this?

19 A. I don't recall.

20 Q. So, you were employed by Proskauer
21 Rose at this time?

22 A. Yes.

23 Q. And you referred IViewIt to
24 Meltzer Lippe?

25 A. I referred IViewIt to Ray Joao,

□

24

1 Rubenstein
2 who I believe was working at Meltzer Lippe at
3 that time.

4 Q. Who did you speak to at IViewIt,
5 sir?

Ken Rubenstein Deposition

6 A. I don't recall.

7 Q. Did you keep any notes of your
8 conversation with regard to this referral?

9 A. No.

10 Q. Did you speak to Mr. Joao with
11 regard to this referral?

12 A. I don't recall.

13 Q. Why did you refer this matter to
14 Meltzer Lippe?

15 A. Because it wasn't work I wanted to
16 undertake myself.

17 Q. And why was that?

18 A. Because I am not generally in the
19 patent prosecution business, in most cases.

20 Q. Did you ever meet with any members
21 of the board of directors of IViewIt.com?

22 A. Not that I know of.

23 Q. Were you ever involved in any
24 meetings with anyone concerning IViewIt.com?

25 A. No, not that I know of.

□

25

1 Rubenstein

2 Q. How about any representative from
3 Real 3 D?

4 A. Never heard of it.

5 Q. How about Warner Bros.?

6 A. Warner Bros. is a client here.

7 Q. Okay. Did you have any
8 discussions with Warner Bros. about IViewIt?

Ken Rubenstein Deposition

9 MR. PRUSASKI: Objection.
10 A. Any --
11 MR. PRUSASKI: Instruct him not to
12 answer.
13 (DIRECTION NOT TO ANSWER.)
14 A. Any conversation I made or had
15 with Warner Bros. would be confidential. I am
16 not saying there was or was not such a
17 conversation, it would be privileged.
18 Q. I am not asking you for the
19 contents of the conversation, I want to know
20 if there was one.
21 A. I am not saying -- I don't know if
22 there was one.
23 And if there was, I wouldn't tell
24 you about it, anyway.
25 Q. How about Hollywood.com?

□

26

1 Rubenstein
2 A. Never heard of it.
3 Q. Did you ever have any discussions
4 with anyone at Proskauer Rose concerning the
5 IViewIt Technologies?
6 A. Not that I recall.
7 Q. Did you have any discussions with
8 anyone -- let's say Chris Wheeler,
9 particularly, at Proskauer Rose with regard to
10 anything at IViewIt?
11 A. I might have, but I don't recall

Ken Rubenstein Deposition

12 anything about it at this time, if I did.

13 Q. Did you ever counsel anyone at
14 IViewIt concerning any matters regarding the
15 patent or patent applications?

16 A. Not that I recall.

17 Q. Did you keep any files yourself
18 with regard to IViewIt and any communications
19 with IViewIt?

20 A. I don't think so, no.

21 MR. PRUSASKI: Objection, asked
22 and answered.

23 Q. Did you ever play a role as an
24 advisory board member for IViewIt?

25 A. Not that I know of, no.

□

27

1 Rubenstein

2 Q. Well, sir, I am a little
3 confused. You normally would recall that you
4 would be on a board of directors --

5 A. I don't think I was on any such
6 board.

7 To my knowledge, I was on no such
8 board.

9 Q. And you never had any
10 communications with any board member from
11 IViewIt; is that a correct characterization --

12 A. I had a -- probably a phone call
13 or two with Brian Utley. I am not sure if
14 he's a board member or not.

Ken Rubenstein Deposition

15 Q. And what were the contents of your
16 conversation with Mr. Utley?

17 A. I don't recall.

18 Q. Did you ever talk to anyone at
19 Warner Bros. with regard to IViewIt?

20 A. You are asking for privileged
21 information, sorry.

22 Q. Well, whether or not you had
23 communications --

24 A. No, you are asking for the content
25 of communications.

□

28

1 Rubenstein

2 Q. No, I am not asking for the
3 content.

4 A. Yes, you are.

5 Q. Please listen to my question.

6 MR. PRUSASKI: Mr. --

7 Q. The question was, did you ever
8 discuss any matters concerning IViewIt with
9 anyone from Warner Bros., period. I am not
10 asking you for the content because, clearly,
11 if you want to assert a claim of privilege on
12 that, and Warner Bros. is a client of yours,
13 then you can assert it, but I am asking you
14 whether or not you had any discussions at
15 all. I am not asking you for the contents.

16 A. I am --

17 MR. PRUSASKI: Mr. Selz, I am
Page 25

Ken Rubenstein Deposition

18 going to object. I am instructing
19 Mr. Rubenstein not to answer. It's
20 privileged attorney/client
21 communication.

22 (DIRECTION NOT TO ANSWER.)

23 MR. SELZ: Not the fact of whether
24 or not he had any discussions --

25 MR. PRUSASKI: I am not arguing.

□

29

1 Rubenstein
2 We are not allowed, under the Florida
3 rules, to argue objections. I am
4 instructing him not to answer.

5 MR. SELZ: I understand.

6 MR. PRUSASKI: And I can't argue
7 with you.

8 MR. SELZ: Just so the record is
9 clear, your objection is it's
10 privileged, whether or not he even spoke
11 to Warner Bros.

12 MR. PRUSASKI: Yes, about IViewIt.

13 MR. SELZ: About IViewIt.

14 MR. PRUSASKI: Yes.

15 Q. Do you know who Greg Thagard is?

16 A. Yes, I do.

17 Q. Who is he?

18 A. He used to work at Warner Bros.

19 Q. He doesn't work with Warner Bros.
20 anymore; is that correct?

Ken Rubenstein Deposition

21 A. Correct.
22 Q. When did you represent Warner
23 Bros., sir?
24 A. Oh, that's not -- that's
25 privileged information, sorry.

□

30

1 Rubenstein
2 MR. PRUSASKI: I am going to
3 object for relevancy, and instruct the
4 witness not to answer. It's also
5 privileged.
6 (DIRECTION NOT TO ANSWER.)
7 MR. SELZ: I don't think case law
8 supports the position that when he
9 represented a client --
10 MR. PRUSASKI: Are we going to
11 argue every time there is an objection?
12 MR. SELZ: No, no, no.
13 A. We will litigate out the issue.
14 We will litigate it out. You know, make a
15 motion. We will fight it. We will see who
16 wins.
17 Q. Mr. Rubenstein again, you know,
18 this is your deposition --
19 A. I don't --
20 Q. -- I appreciate the fact that you
21 want to express your opinion. However,
22 Mr. Prusaski can tell you, this is not how
23 depositions are conducted in the state of

Ken Rubenstein Deposition

24 Florida.

25 A. Fine. I am not discussing

□

31

1 Rubenstein
2 anything about Warner Bros. The objection has
3 been put on the record. Let's move on.

4 MR. PRUSASKI: And, Mr. Selz, just
5 to make it clear, I am going to instruct
6 the client not to answer any questions
7 about any Proskauer clients under claim
8 of privilege and under claim of
9 harassment and under claim of the fact
10 that you are not allowed to put any of
11 this on at trial.

12 MR. SELZ: Well --

13 MR. PRUSASKI: And we can litigate
14 that with Judge Labarga.

15 Q. Now, I am asking you specifically,
16 sir, with regard to any specific meetings, how
17 about Real 3 D?

18 A. I never heard of Real 3 D.

19 Q. You never heard of them, okay.
20 That's what I was going to say.

21 Are you aware of any meeting that
22 happened between yourself and any
23 representatives of IViewIt, other than you
24 have already described?

25 A. Not that I recall. I may have

□

1 Rubenstein
2 also had a conversation with Lamont, but I am
3 not sure.
4 Q. Lamont, you spoke to Stephen
5 Lamont?
6 A. Possibly, yes.
7 Q. And that was concerning IViewIt?
8 A. Maybe, yes.
9 Q. Do you recall what the contents of
10 that conversation were?
11 A. No.
12 Q. How about Zackirul Shirajee, do
13 you know who he is?
14 A. No.
15 Q. How about Jude Rosario?
16 A. Don't know who he is.
17 Q. How about any awareness on your
18 part of any IViewIt inventions regarding zoom
19 imaging?
20 A. I have no knowledge at this point
21 in time of IViewIt technology.
22 Q. So you have no knowledge of scaled
23 video?
24 A. I didn't say that. I said I have
25 no knowledge of what IViewIt technology is at

□

Ken Rubenstein Deposition
Rubenstein

1

2 this point in time.

3 Q. Okay, why don't you explain to me
4 "scaled video", to the best of your
5 knowledge.

6 A. I don't know what you mean by
7 "scaled video".

8 why don't you explain to me what
9 you are talking about.

10 Q. well, what does that mean to you?
11 You seemed to indicate earlier in your answer
12 that you had some idea of what I was talking
13 about.

14 A. well, "scaled video" might refer
15 to changing the sizes of video images.

16 Q. And how is that accomplished?

17 A. I don't know. At this point in
18 time, I am sure there is a variety of
19 techniques to do it.

20 Q. Are you aware of any such
21 techniques that IViewIt was using?

22 A. No.

23 Q. Are you aware of any camera zoom
24 applications used in the IViewIt technology?

25 A. No.

□

34

1 Rubenstein

2 Q. How about combined scaled video
3 zooming video applications?

4 A. Not that I know of.
5 I am not saying they don't or do
6 exist, I am saying I don't know.
7 Q. Of course, it's to the best of
8 your knowledge, sir, I am not expecting you to
9 be on omniscient.
10 How about game applications?
11 A. I have no knowledge of what
12 IViewIt's doing.
13 Q. How about what they have done in
14 the past?
15 A. I have no knowledge of what they
16 have done in the past at this point in time.
17 Q. Is it that you have no knowledge
18 or you can't recall?
19 A. I don't know if I knew in the past
20 or didn't know in the past, I don't know now.
21 Q. So, in other words, sir, you have
22 no knowledge as to any technology that IViewIt
23 uses; is that correct?
24 A. At this point in time, that is
25 correct.

□

35

1 Rubenstein
2 Q. Did you have such knowledge in the
3 past?
4 A. I don't know whether I did or did
5 not, I don't know now.
6 Q. So, then, sir, you wouldn't have

7 any ability to know whether or not any of your
8 clients are using IViewIt technology; is that
9 correct?

10 A. I would have no idea.

11 Q. So it is possible, then, they
12 might be infringing on IViewIt's technologies?

13 MR. PRUSASKI: Object to the form.

14 A. What do you mean by "infringing"?

15 Q. Well, making use of IViewIt
16 technologies without the benefit of royalties
17 or some other kind of licensing.

18 A. I have no knowledge that IViewIt
19 has any proprietary rights in anything. And I
20 have no knowledge about what IViewIt's
21 technology is. So I have no knowledge about
22 who could be doing what.

23 Q. If IViewIt had technologies
24 concerning scaled video, let's say, and there
25 was some legally-protected interest in that

□

36

1 Rubenstein
2 technology, as a patent lawyer, would you
3 opine that the use of that by any other third
4 party would require either a licensing or
5 payment of a royalty?

6 A. I --

7 MR. PRUSASKI: Object to the form.

8 Q. You may answer the question.

9 A. I will answer the question. I

10 would not have an answer to that question in
11 the abstract, you are asking for complex legal
12 analysis of a situation where you are only
13 giving a vague hypothetical fact pattern, so
14 it's not possible to give an answer to that
15 question.

16 Q. well, let me restate it, then,
17 maybe I can make it clearer for you, sir.

18 Let's say that IViewIt has
19 technology for camera zoom applications and
20 that technology is patented, and a client of
21 yours is making use of that technology without
22 the benefit of paying either a royalty or a
23 licensing agreement. would there be legal
24 liability?

25 MR. PRUSASKI: Object to the

□

37

1 Rubenstein

2 form.

3 A. why don't you explain more clearly
4 what you are trying to say.

5 Q. I thought I was trying to be
6 clear. Okay, let me try again.

7 Let's say specifically, and I
8 don't know if this particular entity is a
9 client of yours or not, but Sony used camera
10 zoom applications which were subject to a
11 patent or a patent pending by IViewIt.com, and
12 Sony made use of these technologies without

13 either a licensing agreement or without paying
14 a royalty. Would Sony be liable for damages
15 for use of this patented technology to
16 IViewIt?

17 A. Well, Sony's a client of the firm,
18 so I am not going to discuss what kind of
19 advice I might or might not give to Sony in
20 particular circumstances, you are asking for
21 privileged information.

22 Q. Okay. Then, instead of Sony we
23 will make it company X.

24 A. Like I say, you are asking for a
25 legal conclusion of mine, how I might advise a

□

38

1 Rubenstein
2 client in a particular fact pattern without
3 knowing the details. In order to answer that
4 question, I would have to study the patent in
5 question, the file history of the patent
6 before The Patent Office, the prior art of
7 record. I might have to look for other prior
8 art. I would also have to study what the
9 particular client is doing. I might have to
10 study what other proprietary rights the
11 company in question who owns those rights
12 might have before I would even conceive and
13 think about answering a question like that.
14 Q. We are doing this -- obviously,
15 you have the right to object if it's Sony.

16 what I am saying assuming, arguendo, this is a
17 valid and binding patent intellectual
18 property, that it is only enforceable under
19 the patent that's in place, and that there is
20 a clear case of infringement.

21 A. I answered the question to the
22 best of my ability already. It's on the
23 record.

24 If you want, we can ask the
25 reporter to read it back.

□

39

1 Rubenstein

2 Q. Your statement to me in response,
3 sir, was that you needed more specifics and
4 that you were unclear, and that you would have
5 to --

6 A. No, I told you that in order for
7 me -- I am going to repeat this once, just so
8 we are understanding it -- I told you in order
9 to advise a client in a particular situation,
10 I would have to study the patents in question,
11 the file histories of the patents before the
12 U.S. Patent Office, I would have to study the
13 prior art of record, I might study other prior
14 art, I would have to study the claims of the
15 patent, I would have to try to understand
16 their scope, I would have to try to understand
17 the technology that someone was trying to
18 apply the patents to, I would try to

19 understand whether there were other
20 proprietary rights besides patents in
21 question, and before I could answer the
22 question. I can't answer your question in the
23 abstract, it doesn't have a simple
24 straightforward "Yes" or "No" answer.

25 Q. well, assuming that all your

□

40

1 Rubenstein
2 review of the prior art and your review of the
3 application of the Patent Office and your
4 review of all those other documents that you
5 just mentioned indicated that it was a valid
6 and duly-enforceable patented right with
7 regard to a technology that was clearly
8 infringing on that patent right, would your
9 answer remain the same?

10 A. I answered the question to the
11 best of my ability.

12 Q. How long have you been a patent
13 lawyer, sir?

14 A. You know how long, at least --

15 Q. Go back --

16 A. -- more than 20 years.

17 Q. And how many patent cases have you
18 litigated?

19 A. I have litigated a number of them.

20 Q. How many is "a number of them"?

21 A. Quite a few.

22 Q. More than 50?
23 A. Probably not.
24 Q. More than 20?
25 A. Maybe.

□

41

1 Rubenstein

2 Q. Have any of those patent cases
3 dealt with an infringement claim?

4 A. They generally deal with
5 infringement claims.

6 Q. Could you tell me about the cases
7 that you have been involved with? Just naming
8 the cases.

9 MR. PRUSASKI: Objection.

10 Don't answer the question, it's
11 privileged.

12 (DIRECTION NOT TO ANSWER.)

13 MR. SELZ: The name of the cases
14 are privileged?

15 MR. PRUSASKI: Yes. And it's
16 harassment. He is a 20-year patent
17 lawyer at one of the largest law firms.
18 Why don't we need to go over this?

19 MR. SELZ: It seems to me he is
20 being very evasive about a lot of these
21 things.

22 MR. PRUSASKI: I don't think so.
23 You are asking a really simple
24 question that doesn't have a simple

25 answer.

□

42

1 Rubenstein

2 A. Yes, you are asking a question
3 that doesn't have a simple "Yes" or "No"
4 answer.

5 MR. PRUSASKI: And it is a
6 hypothetical, and he is not an expert.

7 Q. Have you ever met with Mr. Chris
8 wheeler?

9 A. I don't think I ever met him, no.

10 Q. Did you ever speak with him?

11 A. Possibly, yes.

12 Q. Do you have any specific
13 recollection as to when you spoke with him?

14 A. No.

15 Q. Have you ever billed any services
16 to IViewIt or any of the IViewIt entities?

17 A. As far as I know, I have not.

18 Q. Have you been included on a
19 billing statement for IViewIt --

20 A. As far as --

21 Q. -- on Proskauer Rose.

22 A. As far as I know, I have not.

23 Q. Did Mr. wheeler ever consult with
24 you, to the best of your recollection, with
25 regard to any issues concerning IViewIt?

□

43

Ken Rubenstein Deposition

1 Rubenstein

2 A. He might have, but I would not
3 recall the details at this time.

4 Q. would you have taken any
5 contemporaneous notes of those conversations?

6 A. Probably not.

7 Q. would you keep any other records
8 of those conversations?

9 A. I am not a big note taker of phone
10 conversations, so the answer would be no.

11 Q. would those conversations have
12 been reflected in any billing records that you
13 might keep?

14 A. Like I say, to my knowledge, I
15 never billed any services to IViewIt.

16 Q. well, I don't think that was my
17 question.

18 My question was, sir, if you did
19 have a conversation with Christopher wheeler
20 with regard to IViewIt, would it have been
21 reflected on your billing records?

22 A. Probably not, because it would
23 have been a minor short conversation.

24 Q. Did you ever come down to Florida
25 to meet with anyone from IViewIt?

□

44

1 Rubenstein

2 A. No.

Ken Rubenstein Deposition

3 Q. Did you ever make any
4 representation to any party that you can
5 recall with regard to IViewIt or its
6 technologies?

7 A. Not that I recall.

8 MR. PRUSASKI: Object to the form.

9 Q. Let me rephrase that. Have you
10 ever spoken to any third party with regard to
11 IViewIt's technologies?

12 A. Not that I recall at this time.

13 Q. Did you ever meet with anyone
14 named Stephen Filipek?

15 A. I don't know who he is.

16 Q. Were you ever included in any
17 business plan of IViewIt as a consultant or
18 any other representation as being involved
19 with the company?

20 A. Not that I know of at this time.

21 Q. If you were included on that
22 business plan as a consultant or advisor to
23 IViewIt, would you have consented to that or
24 would you have had to have consented to that?

25 A. I don't know whether I would have

□

45

1 Rubenstein
2 had to consent to it or not, and I don't know
3 if I would have consented or not.

4 Q. Have you ever seen a business plan
5 for IViewIt?

Ken Rubenstein Deposition

6 A. I don't know, I might have. I
7 might not have, I don't know.

8 Q. How about, did you ever speak to
9 anyone at Brian Utley?

10 A. I did have one or two phone
11 conversations with him.

12 Q. With regard to IViewIt?

13 A. Yes.

14 Q. And what were the contents of
15 those conversations?

16 A. I --

17 MR. PRUSASKI: Asked and answered.

18 MR. SELZ: I'm sorry.

19 A. And I will just answer it again,
20 for convenience, I don't know the details at
21 this point in time.

22 Q. How about Gerald Stanley?

23 A. I don't know who he is.

24 Q. Wayne Smith?

25 A. I don't think I ever had a

□

46

1 Rubenstein
2 conversation with Wayne Smith about IViewIt.
3 And Wayne Smith is a Warner Bros. in-house
4 attorney and, therefore, any conversation I
5 did have with him would be privileged.

6 Q. How about David Colter?

7 A. I am not sure who he is. I am
8 just not sure.

Ken Rubenstein Deposition

9 You might refresh my recollection
10 and tell me who he is. I am not sure who he
11 is.

12 Q. If you are not sure who he is, I
13 will not go any further.

14 How about a Hassan Miah?

15 A. I don't know who he is.

16 Q. How about Doug Che, with Sony?

17 A. I don't know who he is.

18 Q. Jerry Pierce, from Paramount
19 Viacom?

20 A. I don't know who he is.

21 Q. How about Aden Foley?

22 A. Don't know who he is.

23 Q. Chris Cook?

24 A. I don't know who Chris Cook is.

25 Q. It's Chris Cookson.

□

47

1 Rubenstein

2 A. Any conversation I have had with
3 Chris Cookson would be privileged.

4 Q. Okay. well, you know who Chris
5 Cookson is?

6 A. Yes, I do.

7 Q. Have you ever discussed IViewIt
8 Technologies with him?

9 MR. PRUSASKI: Don't answer the
10 question.

11 I am instructing him not to
 Page 42

Ken Rubenstein Deposition

12 answer.

13 (DIRECTION NOT TO ANSWER.)

14 Q. Did you ever become aware of any
15 problems with Raymond Joao's work as with
16 regard to patents for IViewIt?

17 A. Not that I recall at this time.

18 Q. Does Proskauer Rose maintain
19 patent counsel, other than yourself?

20 A. There are a number of patent
21 people in the law firm.

22 Q. Was there any particular reason
23 why IViewIt's patent applications were not
24 handled by Proskauer Rose?

25 A. Well, like I said, generally, I

□

48

1 Rubenstein

2 don't do patent prosecution work, as a general
3 matter.

4 Q. Did you see anything wrong or
5 faulty with Mr. Joao's work?

6 A. Like I say, I have no knowledge of
7 his work at this time, and don't recall ever
8 seeing anything faulty with it.

9 Q. Was there ever a time when
10 Mr. Joao was no longer employed by Meltzer
11 Lippe, to the best of your knowledge?

12 A. I think he did leave after a
13 certain period of time.

14 Q. And where did he go to work?

Ken Rubenstein Deposition

15 A. I have no idea.
16 Q. Do you have any knowledge as to
17 why Mr. Joao left or --
18 A. No.
19 Q. If you would just let me finish my
20 question, I would appreciate it.
21 MR. PRUSASKI: What was the
22 question?
23 MR. SELZ: I was going to finish
24 the question.
25 Q. Did you have any knowledge as to

□

49

1 Rubenstein
2 why Mr. Joao left or whether or not he was
3 terminated?
4 A. No.
5 Q. Okay. So you have no knowledge,
6 sir, then, of any of the patent applications
7 for IViewIt.com?
8 A. Not at this time, no.
9 Q. How about with regard to any of
10 the trademark or copyright applications?
11 A. No, none whatsoever.
12 Q. Have you ever heard of a company
13 called Zeosync, Z-E-O-S-Y-N-C?
14 A. I am not sure at this time.
15 Q. You are not sure whether or not
16 you have ever heard of it?
17 A. Yeah. Yeah, I don't think I know

Ken Rubenstein Deposition

18 at this time. I am not sure. What do they
19 do?

20 Q. Well, if you don't know what they
21 do and you don't know who they are, then
22 that's your answer.

23 A. All right, that's fine.

24 Q. Who recommended that IViewIt go to
25 Meltzer Lippe for their patent work?

□

50

1 Rubenstein

2 A. I probably suggested it.

3 Q. And was that suggestion
4 communicated in writing?

5 A. Probably not.

6 Q. And, if you can recall, who did
7 you communicate with at IViewIt concerning
8 your recommendation?

9 A. I don't recall.

10 Q. Did you ever meet with Eliot
11 Bernstein?

12 I think you might have said that
13 you never met with him before.

14 A. I don't think I ever met with him.

15 Q. Okay, and you said you don't know
16 who Jude Rosario is; correct?

17 A. Correct.

18 Q. And you don't know who Zackirul
19 Shirajee is; correct?

20 A. Correct.

Ken Rubenstein Deposition

21 Q. How about Jeffrey Friedstein?
22 A. I don't know who he is.
23 Q. Are you aware of whether or not
24 Proskauer Rose accepted any stock from
25 IViewIt?

□

51

1 Rubenstein
2 A. I would have no knowledge of that.
3 Q. Were you ever asked to evaluate
4 for Proskauer Rose the inventions that IViewIt
5 had?
6 A. Not that I recall, no.
7 Q. Did you ever see a video that led
8 you to believe that a company called Visual
9 Data was infringing upon IViewIt?
10 A. I never heard of Visual Data.
11 Q. Are you aware of any of the
12 billings that Proskauer Rose presented to
13 IViewIt for services?
14 A. To my knowledge, I have never seen
15 any such bill.
16 Q. Did you have any discussions with
17 any other partner or associate at Proskauer
18 Rose concerning the billings to IViewIt?
19 A. Not that I could recall.
20 Q. Okay. When I refer to "IViewIt",
21 I mean --
22 A. You mean all of those entities.
23 Q. Correct.

Ken Rubenstein Deposition

24 A. And the answer is, not that I
25 could recall.

□

52

1 Rubenstein

2 Q. Did Mr. Wheeler talk with you at
3 all about any infringement problems or patent
4 rights at IViewIt?

5 A. Not that I recall.

6 Q. And you earlier testified you have
7 never heard of a company called Visual Data;
8 is that correct?

9 A. Not that I can recall at this
10 time.

11 Q. Do you know an individual named
12 Gerald Lewin?

13 A. Gerald Lewin?

14 Q. Yes.

15 A. You mean the former CEO of Time
16 Warner?

17 Q. Yes.

18 A. Well, I know the name, but I don't
19 know him personally.

20 Q. How about Brian Utley?

21 A. Well, I told you already I had a
22 few telephone conversations with him.

23 Q. Other than those telephone
24 conversations, do you know anything of
25 Mr. Utley?

□

1 Rubenstein

2 A. No.

3 Q. How about Gerald Stanley, of
4 Real 3 D?

5 A. I never heard of him and never
6 heard of Real 3 D.

7 Q. You said that earlier.

8 How about Boca Research?

9 A. Never heard of Boca Research.

10 Q. How about Wayne Huizenga Jr. or
11 Sr.?

12 A. Well, I know the name, I don't
13 know them personally.

14 Q. How about Chris Brandon?

15 A. Never heard of him.

16 Q. Robert Henniger?

17 A. Never heard of him.

18 Q. Sportsline?

19 A. Sportsline, S-P-O-R-T-L-I-N-E?

20 Q. Correct.

21 A. I never heard of it.

22 Q. Hollywood.com, I think you
23 testified to earlier.

24 A. You asked me about that, and I
25 answered it already.

□

Ken Rubenstein Deposition
Rubenstein

1

2 Q. Correct.

3 How about Big E?

4 A. I never heard of it.

5 Q. Sensormatic?

6 A. S-E-N-S-O-R-M-A-T-I-C?

7 Q. Right.

8 A. I never heard of it.

9 Q. How about Sensormatics? I'm
10 sorry.

11 A. I don't think I heard of it,
12 either way, to my knowledge right now.

13 Q. How about CrossBow Ventures?

14 A. Well, I only know about it because
15 it was mentioned in some conversation to me
16 prior to this deposition, but I don't have any
17 knowledge of them, never met with them, never
18 had any dealing with them.

19 Q. And what conversation was this,
20 prior --

21 A. In preparation for this
22 deposition.

23 Q. Okay. Do you have any idea who
24 they are?

25 A. I know they are a venture

□

55

1 Rubenstein

2 capitalist, something like that.

3 Q. Are they a client of Proskauer

Ken Rubenstein Deposition

4 Rose?

5 A. I don't know.

6 Q. When Proskauer Rose would
7 represent a new client, would a conflict check
8 be run?

9 A. I think that's the normal
10 procedure of this and most other law firms.

11 Q. When you were contacted or spoke
12 to Mr. Wheeler with regard to IViewIt.com, did
13 you either request that Mr. Wheeler confirm
14 the conflict check had been run or did you
15 conduct one yourself?

16 A. I did not conduct one myself
17 because the client came in through Mr. Wheeler
18 and he -- in the normal procedure, it would be
19 up to him to do the conflict check.

20 Q. Okay, so you relied on the fact
21 that Mr. Wheeler had done one?

22 A. I relied on the fact that it would
23 be the normal procedure in this law firm for
24 him to have done it.

25 Q. But you can't tell me whether or

□

56

1 Rubenstein

2 not today, as you sit here, whether or not one
3 was done.

4 A. I would say it would be the normal
5 procedure in this law firm for it to be done.

6 Q. But do you have any personal

7 knowledge which would indicate to you directly
8 that a conflict check had been run with regard
9 to IViewIt?

10 A. Well, the fact is, in this law
11 firm they would not assign a client billing
12 number to the client without a conflict check
13 being done, and I understand the client
14 billing number was assigned, so that means a
15 conflict check was done --

16 Q. And --

17 A. -- or would normally have been
18 done.

19 Q. Normally, but what I am asking you
20 very specifically is, sir, you do not know for
21 a fact whether or not a conflict check was
22 run?

23 A. Not at this point in time, I do
24 not know.

25 Q. And if there was a conflict found,

□

57

1 Rubenstein
2 what would be the normal procedure?

3 A. It would go to the -- there is a
4 committee that -- in this law firm, that deals
5 with those issues.

6 Q. Does that committees ever obtain
7 waivers of conflicts from clients?

8 A. They might.

9 MR. PRUSASKI: Don't answer the

10 Ken Rubenstein Deposition
question, it's privileged.

11 (DIRECTION NOT TO ANSWER.)

12 Q. Do you maintain any files or any
13 documents concerning IViewIt?

14 MR. PRUSASKI: Him personally?

15 MR. SELZ: In his business records
16 or in his records for Proskauer Rose at
17 the offices in New York.

18 A. Not that I know of, no.

19 Q. Do you know of any patenting of
20 inventions for IViewIt?

21 A. Like I say, I was not involved as
22 their patent counsel, other people served as
23 their patent counsel.

24 Q. Are you aware of any of the
25 particulars of any of those patents?

□

58

1 Rubenstein

2 A. I was not --

3 MR. PRUSASKI: This --

4 A. I will repeat it again, I was not
5 involved as their patent counsel, other people
6 were. And, at this point in time, I have no
7 knowledge of their patent applications.

8 MR. PRUSASKI: Mr. Selz, you are
9 repeating yourself now.

10 MR. SELZ: I'm sorry, Chris.

11 MR. PRUSASKI: Eliot needs to type
12 some new questions.

Ken Rubenstein Deposition
13 A. Maybe he didn't get a good night's
14 sleep.

15 (Pause.)

16 MR. PRUSASKI: Do you have
17 anything else?

18 MR. SELZ: Yes, I do. Just give
19 me a minute. (Pause.)

20 Q. Sir, do you have any knowledge or
21 have you reviewed any of the billing
22 statements that Proskauer Rose provided to
23 IViewIt in this matter?

24 A. No.

25 MR. PRUSASKI: Objection, asked

□

59

1 Rubenstein

2 and answered.

3 Q. Are you aware of any of the
4 services provided by Proskauer Rose to IViewIt
5 in this matter?

6 A. I have no idea.

7 Q. (Pause.)

8 MR. PRUSASKI: Do you have
9 anything else?

10 MR. SELZ: Yes. Just give me a
11 couple of minutes, I am just thinking
12 through this stuff.

13 MR. PRUSASKI: Nothing personal,
14 Mr. Selz, but you are really repeating
15 yourself at this point.

Ken Rubenstein Deposition

16 MR. SELZ: I am trying not to.
17 MR. PRUSASKI: I mean, you asked
18 him twice if he has seen the bills
19 within like three minutes.
20 MR. SELZ: (Pause.)
21 Q. Are you aware of any individuals
22 involved in the MIT Multimedia Lab?
23 A. Personally, no, not at this point.
24 Q. When was the last time you spoke
25 to Brian Utley? You indicated you had a

□

60

1 Rubenstein
2 couple of conversations with him. When was
3 the last discussion held, that you can recall?
4 A. I am not sure.
5 Q. Was it more than a year ago?
6 A. Probably.
7 Q. Do you remember the contents of
8 that conversation at all?
9 A. No. And you asked me that
10 already.
11 Q. I know I did. I am trying to help
12 to refresh your recollection.
13 A. You asked me at least three times
14 that question, so now you are at the point of
15 wasting my time, so I would appreciate it, if
16 you want to ask me some questions, please ask
17 me questions you did not ask me already.
18 Q. Is there anyone else, other than

19 Brian Utley at IViewIt, that you ever had any
20 discussions with?

21 MR. PRUSASKI: You have asked
22 that, about five times.

23 A. You asked me that already.

24 MR. PRUSASKI: And he said no.

25 A. And I answered it already. You

□

61

1 Rubenstein
2 will see the transcript, and you will see the
3 answer.

4 Q. Okay, fine.

5 MR. PRUSASKI: Mr. Selz, is your
6 client sending you questions over the
7 computer?

8 MR. SELZ: No, no, I have got my
9 notes that I have made to ask questions,
10 and I am just trying to correspond
11 Mr. Rubenstein's answers with my
12 questions.

13 MR. PRUSASKI: Are you
14 communicating with him electronically?

15 MR. SELZ: No, I am not.

16 MR. PRUSASKI: Has he been on the
17 phone the whole time?

18 MR. SELZ: Yes.

19 MR. PRUSASKI: He is in
20 San Diego?

21 MR. SELZ: Yes.

22 Ken Rubenstein Deposition
MR. PRUSASKI: Let the record
23 reflect he is taking out time --
24 MR. SELZ: He is sitting in the
25 room next to his wife, waiting for his

□

62

1 Rubenstein
2 wife to go into labor and go into the
3 hospital and --
4 MR. PRUSASKI: And he could have
5 sat in the same room a week-and-a-half
6 ago to have his deposition taken. If he
7 is able to appear at depositions on the
8 telephone, he could have had a
9 deposition taken at his house.
10 MR. SELZ: He can cut out any
11 minute he wants with me, but he can't do
12 it with you, if you have a deposition
13 scheduled.
14 MR. PRUSASKI: We could have
15 accommodated him just fine.
16 MR. SELZ: I am going to put you
17 on hold for a minute.
18 (Pause in proceedings.)
19 MR. SELZ: Okay, Chris, I have
20 been talking to Eliot, he is going to
21 check on his wife, who is in the next
22 room. Let's take a ten-minute break and
23 come right back.
24 MR. PRUSASKI: Okay. I expect you

25 Ken Rubenstein Deposition
both to have some new questions or I

□

63

1 Rubenstein
2 need to go, because we are both very
3 busy.

4 MR. SELZ: I understand, so is
5 everyone.

6 MR. PRUSASKI: So, it's 12:02, we
7 will see you promptly at 12:12 with new
8 questions.

9 Do you want to call us back at
10 this number?

11 MR. SELZ: I will call you back at
12 this number.

13 (Recess taken: 12:04 p.m.-
14 12:16 p.m.)

15 Q. Did you ever receive a letter from
16 Stephen Lamont with regard to IViewIt
17 technology?

18 A. A letter from Stephen Lamont?

19 Q. Yes.

20 A. Not that I know of at this time.

21 Q. Okay.

22 MR. SELZ: Chris, can you give me
23 the fax number there? I will fax you a
24 copy of this letter, for the witness --
25 for the deponent to review.

□

64

Ken Rubenstein Deposition

1 Rubenstein

2 A. I don't know how we are going to
3 orchestrate that.

4 Q. You have got a fax up there?

5 A. We do. We've just got to --

6 MR. PRUSASKI: It's not something
7 that can be delivered immediately?

8 THE WITNESS: Right.

9 MR. SELZ: What I will do is, I
10 will continue with other questions until
11 it's delivered.

12 MR. PRUSASKI: The fax number is
13 969-2900. And you will need to have it
14 delivered to Mr. Rubenstein's office
15 immediately.

16 A. It will probably come out in my
17 E-mail, so we will have to have someone print
18 it out.

19 MR. SELZ: Let me just go and take
20 care of that.

21 Hold on for a moment.

22 (Pause in proceedings: 12:17 p.m.-
23 12:25 p.m.)

24 MR. SELZ: Okay, we are back on.

25 A. Okay.

□

65

1 Rubenstein

2 Q. Okay.

Ken Rubenstein Deposition

3 Now, Mr. Rubenstein, have you
4 looked at any of the billing statements that
5 Proskauer Rose produced to IViewIt in this
6 matter at all?

7 A. Okay, so, number one, you asked me
8 that, I answered it already.

9 Number two, I would like to note,
10 for the record, that we took a break at 12:02,
11 you were supposed to come back at 12:12, you
12 were late, and the first thing you did, upon
13 coming back, was take another break of about
14 nine or ten minutes so you could send me a
15 fax, which could have been sent here in
16 advance. And you are wasting my time by
17 asking me questions that I have already
18 answered.

19 Q. what did you do to prepare for
20 this deposition?

21 A. I met with my attorney.

22 Q. Did you review any documents?

23 A. I reviewed answers to
24 interrogatories briefly that were prepared by
25 Mr. Bernstein.

□

66

1 Rubenstein

2 Q. Did you review any other
3 documents?

4 A. I reviewed a brief segment of
5 Mr. Utley's deposition -- actually, I did not

Ken Rubenstein Deposition

6 review anything from Mr. Utley's deposition,
7 that's a mistake. I may have discussed it
8 with my attorney, but you are getting into
9 privileged information, so I cannot answer it
10 any further.

11 Q. So those are the only things that
12 you reviewed?

13 A. The only thing I looked at was
14 Mr. Bernstein's answers to interrogatories,
15 and I did meet with my attorney.

16 Q. Are you aware, sir, that your name
17 is referenced in billing statements from
18 Proskauer Rose to IViewIt more than a dozen
19 times?

20 A. No, I am not.

21 MR. PRUSASKI: Object to the form.

22 Q. Can you think of any reason, sir,
23 why your name would be mentioned more than a
24 dozen times in billing statements from
25 Proskauer Rose to IViewIt?

□

67

1 Rubenstein

2 A. I had a few conversations with
3 different people about the company over time,
4 as I have testified.

5 Q. And you testified that the
6 conversations took place between you and Chris
7 wheeler and you and Brian Utley.

8 A. Right.

Ken Rubenstein Deposition

9 Q. Correct?
10 A. Possibly -- I don't know if there
11 was anyone else.
12 Q. Do you have any recollection now
13 as to any other conversations?
14 A. No.
15 Q. Now, with regard to E-mails, were
16 you aware of any E-mails that you received
17 from anyone concerning IViewIt?
18 A. I don't know at this point in
19 time.
20 Q. Do you have records of E-mails
21 that you received?
22 A. I would not know at this point in
23 time.
24 Q. Are they normally kept as part of
25 your files?

□

68

1 Rubenstein
2 A. I don't know at this point in
3 time.
4 Q. I had asked you previously, sir,
5 whether or not you had any information on
6 Mr. David Colter.
7 Do you recall that?
8 A. Yes, and I said I wasn't sure who
9 he was, and I suggested you might want to
10 refresh my recollection, and you declined to
11 do so.

Ken Rubenstein Deposition

12 Q. Okay. would it refresh your
13 recollection, sir, if I tell you that
14 Mr. Colter was with Warner Bros.?

15 A. You know, I may have heard the
16 name, but I don't think I ever had any
17 dealings with him, although I am not sure.

18 Q. But you do have dealings with
19 Warner Bros.; is that correct?

20 A. Like I said, Warner Bros. is a
21 client.

22 Q. Right. would there be any reason
23 why your name would be mentioned in E-mails,
24 that you can think of, from Warner Bros. to
25 someone at AOL?

□

69

1 Rubenstein

2 A. I don't know.

3 I mean, I do work -- they are part
4 of the same company, they are clients of the
5 firm, and so, I can't really discuss it
6 because of privilege.

7 Q. Sir, you had indicated earlier you
8 had no idea with regard to any of the
9 intellectual properties or patents for
10 IViewIt; is that correct?

11 A. Not at this point in time.

12 Q. Did you ever issue any opinion to
13 anyone as to the validity of those patents?

14 A. Not that I know of.

Ken Rubenstein Deposition

15 Q. Did you ever provide any
16 information at all with regard to the validity
17 of any of these patents?

18 A. Not that I know of.

19 Q. So it's possible that you have in
20 the past but you don't recall?

21 A. I don't recall having involvement
22 with these patents. I was not the patent
23 counsel.

24 Q. Now, sir, we have faxed you a copy
25 of a letter. I don't know if you have

□

70

1 Rubenstein
2 received it.

3 A. We don't have it yet.

4 Q. Okay, could you find out if that's
5 available?

6 A. All right. We will put you on
7 hold.

8 Q. Thank you.

9 (Pause in proceedings.)

10 Q. Okay, are you with me?

11 A. Yes.

12 Q. Do you have the fax?

13 A. No, I do not. Like I say, you
14 should have sent it up here yesterday or in
15 advance.

16 Q. That's fine, that's fine. I was
17 expecting that maybe you would have a better

Ken Rubenstein Deposition

18 recollection of some of these events, and
19 maybe that was my incorrect presumption,
20 considering that I guess the communication
21 from Stephen Lamont occurred relatively
22 recently --

23 A. Well, when did it occur?

24 Q. Well, that's what I was going to
25 ask you, first of all, if you can recall.

□

71

1 Rubenstein

2 A. Well, you asked me about that, and
3 I told you I may have spoken to him once, but
4 I don't recall the details right now.

5 Q. Now, with regard to what we talked
6 about earlier was the conflict of interest and
7 whether or not Proskauer Rose's position in
8 representing IViewIt constituted a conflict
9 with other clients, I think you mentioned that
10 you expected Mr. Wheeler to do the conflict
11 check; is that correct?

12 A. Yes.

13 Q. Are you aware of any conflict of
14 interest between IViewIt and any of your own
15 clients?

16 A. No.

17 MR. PRUSASKI: What's the
18 relevancy of that, Mr. Selz?

19 MR. SELZ: I think it goes to
20 whether or not IViewIt should have been

Ken Rubenstein Deposition

21 represented by Proskauer Rose in the
22 first place.

23 MR. PRUSASKI: Oh, is that a new
24 theory that you haven't pled?

25 MR. SELZ: Is that an objection?

□

72

1 Rubenstein

2 MR. PRUSASKI: Yes, it's objection
3 to relevance.

4 MR. SELZ: Okay, so noted for the
5 record.

6 Q. Mr. Rubenstein, you had indicated
7 that you are not aware of any conflicts
8 between IViewIt and any of your other clients;
9 is that correct?

10 A. Not at this point in time, no.

11 Q. Were you aware of any conflicts in
12 the past?

13 A. Not that I know of.

14 Q. Would there be any records kept of
15 any conflict check that was run by Mr. Wheeler
16 or any other --

17 A. I don't know.

18 Q. Would you let me finish my
19 question, please.

20 -- Mr. Wheeler or any other
21 partner or associate of your firm.

22 A. I don't know what records there
23 might be.

Ken Rubenstein Deposition

24 Q. You indicated there was a conflict
25 committee. Does that conflict committee meet

□

73

1 Rubenstein
2 in New York or do they meet in Florida or is
3 there any particular location for their
4 meetings?

5 MR. PRUSASKI: Objection,
6 relevance.

7 You can answer this question, but
8 it's not going to get much further.

9 A. I assume they meet in New York.

10 Q. Is there any particular reason for
11 that assumption?

12 A. Most of the law firm is in
13 New York.

14 Q. Sir, I am a little confused about
15 some of your earlier testimony. I had asked
16 you whether or not you had spoken with any of
17 your clients concerning IViewIt and its
18 technology, and your response was to claim
19 privilege. Is that still the case, you are
20 claiming privilege with regard to any of those
21 communications?

22 MR. PRUSASKI: Yes.

23 A. Yes.

24 Q. Okay. I am going to just say at
25 this point that you testified that there were

1 Rubenstein
2 only two occasions that you had spoken with
3 third parties Mr. Utley and Mr. Wheeler that
4 you can recall with regard to IViewIt; is that
5 correct?

6 MR. PRUSASKI: I don't recall that
7 being his testimony.

8 A. That's not my testimony.

9 Q. What was your testimony?

10 A. We will have to have it read
11 back. I don't remember exactly what I said --

12 Q. Okay.

13 A. -- in response to which particular
14 question right now.

15 Q. Well, let me pose a new question,
16 sir, and I think I have asked you this before,
17 and I am going to pose it again because I am
18 unclear now.

19 You have communicated with third
20 parties with regard to IViewIt; is that
21 correct?

22 A. Well, what do you mean by "third
23 parties"?

24 Q. People or entities other than
25 IViewIt.

Ken Rubenstein Deposition
Rubenstein

1

2 A. Uh -- I might have, I might not
3 have, I am not sure right now.

4 Q. And those third parties you are
5 saying are clients of yours, is that why you
6 are asserting a privilege?

7 A. Well, it depends who you mean by a
8 "third party". You know, "third party" is a
9 vague term.

10 why don't you name some particular
11 third parties and I will answer the question,
12 if I have haven't answered it already.

13 Q. I think you said that you were
14 asserting a privilege with regard to Warner
15 Bros., I think you said --

16 A. Well, Warner Bros. is a client
17 here.

18 Q. Right. And Sony.

19 A. Sony is a client here.

20 Q. Right. So you refuse to answer
21 whether or not you had communicated to those
22 parties with regard to IViewIt; is that
23 correct?

24 A. Correct, or anything else I might
25 have communicated to them.

□

76

1 Rubenstein

2 Q. Well, I am not asking you about
3 anything else, because, really, frankly, sir,

4 that's not only not relevant but, clearly,
5 that would be privileged, but I am asking you
6 with regard to simply IViewIt --

7 A. Well, you know, that's our
8 position, our position is that any
9 conversation with those entities is
10 privileged.

11 Q. Okay, and if there was a
12 discussion -- are you saying there was no
13 discussion or are you saying there was a
14 discussion that was privileged?

15 A. I am not saying there was a
16 discussion, I am not saying there was not a
17 discussion, I am saying it's privileged.

18 Q. So you can't simply answer no,
19 there was no discussion --

20 A. I am not saying there was, I am
21 not saying there was not, I am saying it's
22 privileged.

23 MR. SELZ: I am going to certify
24 that question, we will take it up with
25 Judge Labarga and see what his

□

77

1 Rubenstein
2 determination is about that.

3 (RULING SOUGHT.)

4 Q. Now, with regard to any other
5 issues concerning IViewIt.com or any IViewIt
6 entities, have you had any communications

7 since the filing of this lawsuit with anyone
8 concerning IViewIt?

9 A. Well, I don't know when the
10 lawsuit was filed.

11 Q. Since 2001, have you had any
12 communications with anyone concerning IViewIt
13 Technologies or any of the IViewIt entities?

14 A. Not that I recall at this time.

15 Q. Have you spoken to Ray Joao with
16 regard to it?

17 MR. PRUSASKI: Asked and
18 answered.

19 A. You asked me about Ray Joao
20 already.

21 Q. Since 2001.

22 A. Not that I know of at this time.

23 Q. Sir, have you ever been involved
24 in setting up corporations for clients?

25 A. No.

□

78

1 Rubenstein

2 Q. Have you ever made any
3 representations to any company or any entity
4 with regard to the advisability of setting up
5 corporations for them?

6 A. Not that I know of.

7 Q. Who would you refer that to at
8 Proskauer Rose if there was --

9 A. I am not sure, it would depend on

10 the particular situation.
11 Q. Do you have any idea what
12 Mr. Wheeler's specialization is?
13 A. No.
14 Q. Have you ever spoken with him with
15 regard to the legal services he was providing
16 to IViewIt?
17 A. You asked me that --
18 MR. PRUSASKI: Asked and
19 answered.
20 A. -- already and I answered it.
21 Q. And what was your answer again,
22 sir, "No"?
23 A. I don't remember the exact
24 question you asked, so I don't remember the
25 exact wording of my answer, what the question

□

79

1 Rubenstein
2 was -- but the question was asked and
3 answered.
4 Q. Do you have that fax yet?
5 A. No. We will call my secretary
6 again.
7 I will put you on hold.
8 Q. Okay.
9 (Pause in proceedings.)
10 A. Okay, the fax is coming, so we are
11 just going to put you on hold for a minute.
12 Q. Thank you?

13 Ken Rubenstein Deposition
(Pause in proceedings: 12:35 p.m.-
14 12:41 p.m.)
15 A. All right. We have your letter.
16 Q. Do you ever recall seeing this
17 letter?
18 MR. SELZ: Let's get it marked,
19 first of all, by the court reporter as
20 Defendants' 1.
21 A. The letter is dated today, and I
22 never saw it before.
23 Q. Have you ever seen the contents of
24 this letter?
25 A. No. I haven't read the letter

□

80

1 Rubenstein
2 yet.
3 Q. Okay.
4 A. I note that the letter is two-plus
5 pages long, I haven't read it. The letter is
6 dated today, November 20, 2002, and it's
7 unsigned, so this is a letter you guys,
8 IViewIt, created today.
9 Q. Well, I think that's a presumption
10 that you are putting into the record, sir.
11 A. Well, the letter I have in front
12 of me is dated today.
13 Q. Let me go ahead.
14 First of all, let's get it marked
15 as Number 1, Defendants' 1.

Ken Rubenstein Deposition

16 MR. PRUSASKI: Objection to the
17 predicate, he has never seen it before.
18 MR. SELZ: Let me ask him a
19 question about it first. I haven't even
20 examined him on it. Let me -- Chris,
21 this is my deposition of him, and I
22 appreciate the fact that he wants to get
23 this over, but that isn't an excuse for
24 him to jump the gun.
25 MR. PRUSASKI: I have a right to

□

81

1 Rubenstein
2 make objections as I see fit, and I am
3 not taking instructions out of practice
4 law from you.
5 MR. SELZ: That's fine. I am just
6 saying, let me get it marked first.
7 (Deposition Exhibit Defendants' 1,
8 letter dated, November 20, 2002, with
9 fax transmittal cover sheet, was marked
10 for identification, as of this date.)
11 Q. Mr. Rubenstein, do you have in
12 front of you what's been marked as Defendants'
13 Number 1? Is that correct?
14 A. Yes.
15 Q. Okay, could you please read it for
16 me?
17 MR. PRUSASKI: Out loud?
18 Q. No, to yourself.

19 A. well, I will scan it, but I want
20 to note it's a two-page letter, I have not had
21 an opportunity to study it. So if you ask me
22 questions about the letter, I am going to tell
23 you I have not had an opportunity to study it.
24 Q. Okay, then I will go through the
25 letter paragraph by paragraph with you to see

□

82

1 Rubenstein
2 if you recall any of it.
3 Do you ever recall receiving a
4 correspondence from Stephen Lamont?
5 A. Like I say, I haven't had a chance
6 to study your letter.
7 Q. I am not talking about this
8 particular --
9 A. I don't recall any correspondence
10 from Stephen Lamont at this point in time.
11 Q. Do you ever recall a request by
12 Wayne Smith of Warner Bros. as to IViewIt's
13 pending patents?
14 A. No. It might be that somebody at
15 IViewIt asked me to talk to Warner Bros. and I
16 declined. That might be the fact.
17 Q. Are you aware of any
18 confidentiality agreement executed by Warner
19 Bros. with regard to IViewIt?
20 A. No.
21 Q. Have you ever seen any such

22 agreement?

23 A. Not that I could recall.

24 Q. Again, sir, this letter refers to
25 you being on the advisory board of IViewIt

□

83

1 Rubenstein

2 between fall of 1999/spring of 2000.

3 A. I was never on any advisory board
4 of IViewIt.

5 Q. Did Stephen Lamont ever meet with
6 you in person?

7 A. I think I -- as I testified, I may
8 have had a conversation with him, I don't know
9 if it was in person or not.

10 Q. You previously testified that you
11 had never reviewed any of IViewIt's
12 technologies; is that correct?

13 A. I never testified to that. What I
14 told you is, I don't have any knowledge of it
15 right now.

16 Q. Okay.

17 A. I don't know whether I reviewed it
18 or not.

19 Q. So it's possible, then, sir, that
20 you did review it.

21 A. Like I said, I answered the
22 question. You asked me, I answered it. I
23 don't know whether I reviewed it or not. I
24 have no knowledge of it right now. I was not

Ken Rubenstein Deposition
25 their patent attorney, I was not involved with

□

84

1 Rubenstein

2 their patents.

3 Q. Okay, if you don't have a
4 recollection of reviewing it, but then it's
5 possible that you had; is that correct?

6 MR. PRUSASKI: Anything's
7 possible. I think we could stipulate to
8 that.

9 A. Right, I don't think it's possible
10 but -- and I don't think it happened.

11 Q. Do you have any clearer
12 recollection of it because of this letter?

13 A. No, I don't have a detailed
14 recollection or any recollection of it at this
15 point in time.

16 Q. And, again, I think you had
17 testified that you don't know anyone -- Greg
18 Thagard, you don't know Greg Thagard?

19 A. I do know Greg Thagard.

20 Q. Who is Greg Thagard?

21 A. He used to work at Warner Bros.

22 Q. Does Mr. Thagard, to the best of
23 your knowledge, have any information
24 concerning IViewIt?

25 A. I don't know at this point in

□

85

Ken Rubenstein Deposition

1 Rubenstein

2 time.

3 Q. What, to the best of your
4 recollection, was Greg Thagard's role with
5 regard to IViewIt?

6 A. I don't know what he might or
7 might not have done with respect to IViewIt.

8 Q. Who is Greg Thagard?

9 A. He is a person who worked at
10 Warner Bros.

11 Q. Well, what was his position --

12 A. He was in technical -- in the
13 technology side of the company.

14 Q. Do you have any idea where
15 Mr. Thagard is currently?

16 A. No. I believe he left the
17 company.

18 Q. How about Chris Cookson, did you
19 ever have any conversations with Chris Cookson
20 concerning IViewIt Technologies?

21 A. Like I say, Chris Cookson works
22 for Warner Bros., and any conversations I had
23 with Warner Bros. are privileged. So, I am
24 not saying I had a conversation, I am not
25 saying I did not have a conversation, I am

□

86

1 Rubenstein

2 saying you are asking for privileged material.

Ken Rubenstein Deposition

3 Q. And David Colter?

4 A. I am not sure I ever had any
5 dealings with him.

6 Q. And who is David Colter?

7 A. You asked and I answered that
8 question already.

9 Q. So you have never seen this
10 correspondence, you don't recall seeing this
11 correspondence from Mr. Lamont; is that
12 correct?

13 MR. PRUSASKI: It's dated today.

14 A. It's dated today.

15 MR. PRUSASKI: It's marked
16 "Draft". It's impossible for us to
17 have seen it before. And the return
18 address is an empty house in Los Angeles
19 County.

20 Q. Have you ever seen the contents of
21 this letter before?

22 A. I have never --

23 MR. PRUSASKI: He answered these
24 questions, no?

25 A. I have never seen the letter

□

87

1 Rubenstein

2 before.

3 Q. How about the E-mails that were
4 faxed over to you, as well? There is an
5 E-mail that's dated August 6, 2001. Have you

Ken Rubenstein Deposition

6 ever seen that E-mail before?

7 A. Is this an E-mail from David
8 Colter to Heidi Krauel?

9 Q. Correct.

10 MR. PRUSASKI: The one dated
11 August 1, 2001?

12 MR. SELZ: Correct.

13 A. Right, I see the E-mail.

14 Q. Okay.

15 MR. SELZ: Let's get it marked as
16 2.

17 (Deposition Exhibit Defendants' 2,
18 fax transmittal cover sheet and E-mails,
19 was marked for identification, as of
20 this date.)

21 Q. Sir, do you have any reason to
22 know why your name is mentioned in that
23 E-mail?

24 A. No, because I don't recall giving
25 any opinions about the patents.

□

88

1 Rubenstein

2 Q. And you never, to the best of your
3 recollection, had any discussions with
4 Mr. Thagard with regard to same, either?

5 A. Like I say, any discussion I might
6 have or might not have had with Mr. Thagard
7 would be privileged.

8 Q. I am going to put you on hold for
Page 79

Ken Rubenstein Deposition

9 just a minute.

10 (Pause.)

11 MR. SELZ: Okay, we are back on.

12 Okay, I have got nothing further
13 at this time. However, we are going to
14 have to go to Judge Labarga with regard
15 to your refusal to answer on some of
16 these issues with your claim of
17 privilege, so we may have to come back
18 and conclude with those questions at a
19 later date.

20 MR. PRUSASKI: Fine.

21 THE WITNESS: We will take it
22 under advisement.

23 We are not committing to come back
24 or not.

25 MR. SELZ: That's fine.

□

89

1

2 (Time noted: 12:48 p.m.)

3

4

5

KENNETH RUBENSTEIN

7

8 Subscribed and affirmed

9 before me this ____ day

10 of _____, 2002.

11 _____

Ken Rubenstein Deposition

12
13
14
15
16
17
18
19
20
21
22
23
24
25

□

90

1
2
3
4
5
6
7
8
9
10
11
12
13
14

C E R T I F I C A T E

STATE OF NEW YORK)
 : ss.
COUNTY OF NEW YORK)

I, WENDY D. BOSKIND, a Registered
Professional Reporter and Notary Public
within and for the State of New York,
do hereby certify:

That KENNETH RUBENSTEIN, the
witness whose deposition is hereinbefore
set forth, affirmed before me, and
that such deposition is a true and
accurate record of the testimony given

Ken Rubenstein Deposition

15 by the witness.

16 I further certify that I am not
17 related to any of the parties to this
18 action by blood or marriage, and that
19 I am in no way interested in the
20 outcome of this matter.

21 IN WITNESS WHEREOF, I have
22 hereunto set my hand this 26th day
23 of November, 2002.

24
25 _____
WENDY D. BOSKIND, RPR

□

1

2 November 20, 2002

3 I N D E X

4 WITNESS	EXAMINATION BY	PAGE
5 Kenneth Rubenstein	Mr. Selz	4

6

7 ----- EXHIBITS-----

8 Defendants' 1, letter dated, November 20,		
9 2002, with fax transmittal cover sheet.....		81
10 Defendants' 2, fax transmittal cover		
11 sheet and E-mails.....		87

12

13

14 (DIRECTION NOT TO ANSWER.).....	25
15 (DIRECTION NOT TO ANSWER.).....	28
16 (DIRECTION NOT TO ANSWER.).....	30
17 (DIRECTION NOT TO ANSWER.).....	41

Ken Rubenstein Deposition

18 (DIRECTION NOT TO ANSWER.)..... 47
19 (DIRECTION NOT TO ANSWER.)..... 57
20
21 (MOTION TO STRIKE.) 10
22
23 (RULING SOUGHT.)..... 77
24
25

□

1
2 STATE OF NEW YORK) Pg__of__Pgs
3) ss:
4 COUNTY OF NEW YORK)
5 I wish to make the following changes,
6 for the following reasons:
7 PAGE LINE
8 ____ ____ CHANGE: _____
9 REASON: _____
10 ____ ____ CHANGE: _____
11 REASON: _____
12 ____ ____ CHANGE: _____
13 REASON: _____
14 ____ ____ CHANGE: _____
15 REASON: _____
16 ____ ____ CHANGE: _____
17 REASON: _____
18 ____ ____ CHANGE: _____
19 REASON: _____
20 ____ ____ CHANGE: _____

Ken Rubenstein Deposition

21 REASON: _____
22 _____ CHANGE: _____
23 REASON: _____
24 _____ CHANGE: _____
25 REASON: _____

□



PROPOSED RYJO, INC. AGREEMENT

4.3 Ownership of Java Applet.

(a) The Parties acknowledge that Developer has developed, on behalf of Customer, the Java computer program task specific application “applet” that facilitates zooming and panning of JPEG images (the “Java Applet”). The Parties further acknowledge that the Java Applet is part of the Deliverables hereunder and does not include Developer Software. Customer shall pay Developer for the cost of developing the Java Applet in the amount set forth in Exhibit D attached hereto. The Java Applet is the exclusive property of the Customer, as it is part of the Customer Materials set forth in Section 4.1 above. Subject to the license granted under Subsection (b) below, Customer retains all right, title, interest in and to the Java Applet.

(b) Customer hereby grants to Developer a royalty free, worldwide, perpetual, irrevocable, non-exclusive right and license, with full rights to sublicense, to make, have made, use, offer for sale, sell, import, reproduce, distribute, modify, publicly perform, and publicly display the Java Applet.



COMMENTS ON PROPOSED RYJO AGREEMENT BY DOUGLAS BOEHM OF FOLEY AND LARDNER.

-----Original Message-----

From: Boehm, Douglas A. [mailto:daboehm@foleylaw.com]

Sent: Friday, June 09, 2000 1:31 AM

To: 'Brian Utley (Iviewit)'

Subject: Ryjo Agreement

Brian--

Here's a Word version (.doc) and an Acrobat version (.pdf) of the Ryjo agreement. Please don't send them any electronic version -- only paper copies. Otherwise they may take liberties with the language and it will take a lot longer to review. If you don't meet with them in person, you can send them only the Acrobat version (its not as easy to modify).

I didn't write alternative language for the Java Applet ownership Section 4.3 yet, because if you can negotiate this language, you will save the cost of my time in doing so (which could be put toward the payment for the Java Applet per Exhibit D). Besides, it would be more efficient to make this change with any other changes that may be required.

It is important that this agreement cover all the PAST development work done by Ryjo for Iviewit, so you'll have to BACK-DATE the agreement in the preamble to a date BEFORE ANY WORK WAS DONE. If you are not sure of the date, I see no reason why you can't back-date it to January 1st of the appropriate year. I also assume that you paid them for the past work, otherwise you may be in breach of the agreement as soon as you sign it. Note that the specifications are a very important part of any development agreement, particularly since they are the basis for determining whether or not a breach of the agreement has occurred. Please be sure that the specifications are accurate and complete. I'd be concerned about signing anything without the Specifications.

If Developer had anything to do with the preparation of the Specification (which is the basis of the performance warranty) such that Customer is relying on Developer's skill or judgment in selecting, defining, or designing the Deliverables or the hosting equipment or personnel, then we should re-think whether we should let the Developer disclaim the implied warranties of merchantability and fitness of a particular purpose in Section 6.6.

If the value of the development Services is sufficient, I recommend that staggered payments be made in accordance with the Developer meeting particular development milestones. Such development milestones should be set forth in detail on Exhibit B and probably take the place of the Delivery Schedule set forth on Exhibit A. If the delivery dates have past, just put down the past dates or today's date or something. I wouldn't suggest that you write "completed" or something equivalent because that may be interpreted as an acceptance under Section 3.2 (which only gives you ten days to reject it anyway).

This version assumes that the Developer will NOT be providing Hosting



Services. If this is not correct, changes need to be made to this agreement.

The issue of confidentiality of the Java Applet may still cause some problems. Since Section 4.3(a) states that the Java Applet was created by Developer specifically for use in connection with its services provided under this Agreement, it qualifies as Confidential Information under the definition of Section 5.1 of the Agreement. However, Section 5.2 prevents the Developer from using the Java Applet elsewhere and from disclosing it to any third party. Nevertheless, the exclusions under Section 5.3 may apply if the Developer developed the Java Applet before the Effective Date. If you think the Java Applet does contain any Confidential Information, we should address this issue. If not, which is what I presume is the case, I suggest that we ignore it.

Please be sure to re-read it before you sign it. I'd be happy to make any changes for you.

Let me know how it goes tomorrow.

--Doug

Douglas A. Boehm

Foley & Lardner

777 East Wisconsin Avenue

Milwaukee, Wisconsin 53202

Tel: (414)297-5718

Fax:(414)297-4900

Email: daboehm@foleylaw.com



EXHIBIT J

COMPANY'S TECHNOLOGY SPECIFICATION FOR VIDEO SCALING

VIDEO WORK FLOW

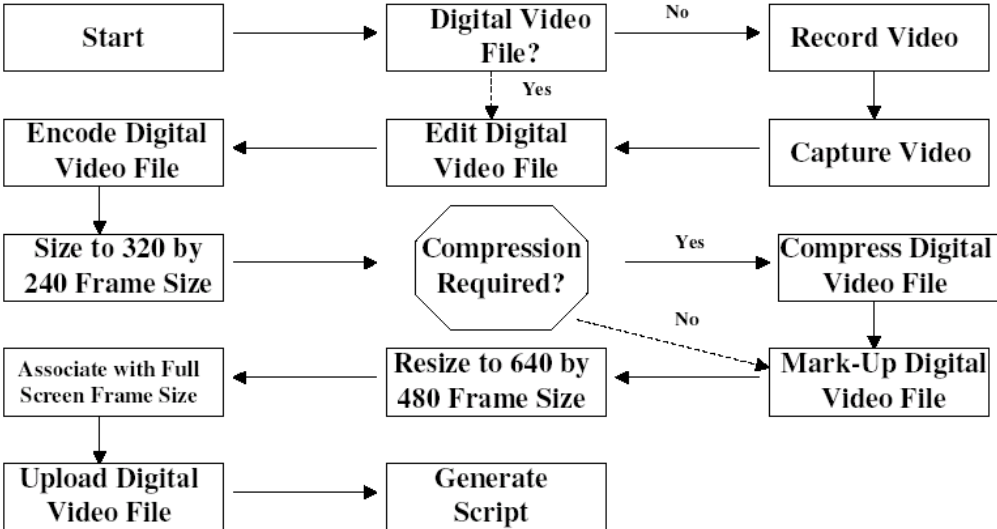

RESPONDENT'S SUBMISSION OF VIDEO DISCLOSURE TO MR. JOAO

PROSKAUER ROSE LLP

2295 Greco Road
Suite 340 West
Socastone, FL 33431-1360
Telephone 561.241.7400
Nowhere in Florida
432.7745
Fax 561.241.7145

NEW YORK
LOS ANGELES
WASHINGTON DC
CHICAGO IL
PARIS

PERSONAL AND CONFIDENTIAL

Fax Transmittal

Date June 1, 1999	Client-Matter 0894/40017/001	Sender's Room Number
Total Pages (including Cover) 2		Main Fax Operator 561.241.7400
From Christopher C. Wheeler		Fax No. 516.747.9363
Sender's Voice Number 561.995.4702		Voice No. 516.747.0300.x240
To Ray Joao		
Company Meltzer, Lippe		

Message

The attached is from Eliot Bernstein.

*EB
561-417-4470*

*6/25
B.W.I
35.0*

Confidentiality Note: This message is confidential and intended only for the use of the addressee(s) named above. It may contain legally privileged material. Dissemination, distribution or copying of this message, other than by such addressee(s), is strictly prohibited. If you have received this message in error, please immediately notify us by telephone and return the original to us at the address above. We will reimburse you for the cost of the telephone call and postage. Thank you.
0894/40017-001 BRLB/231297 v1

06/01/99 01:07 PM (27/3)



PATENT FOR VIDEO TECHNOLOGY

- > Step 1. Is to record the video under any format, beta, VHS, digital, any of the standard file formats. *VHS, digital, beta, VHS, digital, any of the standard file formats.*
- > Step 2. After the video is shot, the second step is to capture the video using any capture device and capture software. *Adobe Premier ~~5.1~~ VERSION 5.1 or Real Producer 5.2*
- > Step 3. Is to edit the video, if necessary, using any standard video editing tools. *Final Cut Pro*
- > Step 4. Is to convert to real video format. *Real Producer 5.2*
- > Step 5. Then we manually set the size of the video within the HTML code to 640 by 480. *Frame Resolution or size can be 600x400, 1024x768, 1280x1024, 1600x1200*
- > Step 6. We then post to the Web using any Web FTP software. *WS FTP 4.00*
- > Step 7. We then write an Ascii file that calls the real video to stream. This makes it a streaming real at full screen with very good clarity and quality. Under Step 7 we write a separate script saved as our *.rm (star.rm) file that will call the original real video file. This script is included in the HTML codes. For MPEG videos, we follow Steps 1 through 3 the same, then we, in Step 4, convert, if not already, to the MPEG format. 5, insert the video in the HTML codes and expand to 640 by 480. Then we upload the video file to the Web in Step 6. Step 7, this MPEG file is played from the Web by first downloading a small portion of the file and played through the necessary player or any player, actually, that supports AVI, MPEG-type video formats.

This tape was recorded on 6/1/99 at the law firm of Proskauer Rose LLP.



PROVISIONAL PATENT FILING 60/137,297 BY MR. JOAO UNDER SUPERVISION OF RESPONDENT THE EVIDENCE OF WHICH IS ATTESTED TO BY SECTION 3.A. ABOVE

PFO-105P (Rev. 8-88)

PROVISIONAL APPLICATION FILING RECEIPT



UNITED STATES DEPARTMENT OF COMMERCE Patent and Trademark Office ASSISTANT SECRETARY AND COMMISSIONER OF PATENTS AND TRADEMARKS Washington, D.C. 20231

Table with columns: APPLICATION NUMBER, FILING DATE, FEE REC'D, ATTORNEY DOCKET NO., DRWGS. Row 1: 60/137,297, 06/03/99, \$75.00, 5865-3, 0

RAYMOND A JOAO MELTZER LIPPE GOLDSTEIN & SCHLISSEL PC 190 WILLIS AVENUE MINEOLA NY 11501

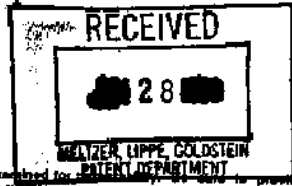

Receipt is acknowledged of this Provisional Application. This Provisional Application will not be searched for... the PROVISIONAL APPLICATION NUMBER, FILING DATE, NAME OF APPLICANT, and TITLE OF INVENTION when inquiring about this application. Fees transmitted by check or draft are subject to collection. Please verify the accuracy of the data presented on this receipt. If an error is noted on this Filing Receipt, please write to the Provisional Application within 10 days of receipt. Please provide a copy of the Provisional Application Filing Receipt with the changes noted therein. This Provisional Application will automatically be abandoned twelve (12) months after its filing date and will not be subject to revival to restore it to pending status beyond a date which is after twelve (12) months from its filing date.

Applicant(s) ELIOT BERNSTEIN, BOCA RATON, FL.

IF REQUIRED, FOREIGN FILING LICENSE GRANTED 06/22/99 ** SMALL ENTITY ** TITLE APPARATUS AND METHOD FOR PRODUCING ENHANCED VIDEO IMAGES



Attorney Docket No. 5865-3

**APPARATUS AND METHOD FOR PRODUCING
ENHANCED VIDEO IMAGES**

The present invention is directed to an apparatus and a method for producing enhanced video images. A preferred embodiment of the invention is described in the following manner.

- Step 1. Record the video under any format, i.e., beta, VHS, digital, and/or any of the standard file formats, including, but not limited to, *.AVI, *.MOV, *.MPEG, etc., by utilizing an appropriate recording device such as a video camera, a film camera, a reel-to-reel recording device, and/or a live video recording device.
- Step 2. After the video is shot, the second step is to capture the video using any capture device such as a capture card or capture hardware, such as provided by Dazzle, and also by using capture software such as Adobe Premier version 5.1 or Real Producer G2.
- Step 3. Edit the video, if necessary, by using any standard video editing tools, such as, for example, Adobe Premier 5.1.
- Step 4. Convert the data and/or information obtained to a real video format such as, but not limited to, a *.RM format.
- Step 5. Manually set the size of the video within the HTML code to a 640 x 480 frame resolution, or any other suitable resolution, such as, but not limited to, 800 x 600, 1024 x 768, 1280 x 1024, 1600 x 1200.
- Step 6. Post the obtained file to a Web page, Web site and/or to the Web, by using any Web FTP software, such as, but not limited to, WS FTP PRO.
- Step 7. Generate or write an ASCII file that calls the real video to stream. This results in streaming real video at full screen with very good clarity and quality. Under Step 7 a separate ASCII file is written and saved as an *.RPM file, or other suitable format, that will call the original real video file. This script is included in the HTML codes. For MPEG videos, Steps 1 through 3 are followed as described above. In Step 4, the file is converted, if not previously converted, to an MPEG format. Next, the video is inserted into the HTML codes and expanded to a 640 by 480 resolution, or higher resolution. Then the video file is uploaded to the Web page Web site, and/or the Web in Step 6. Thereafter, at Step 7, the MPEG file is played from the Web page, Web site and/or from the Web, by first downloading a small portion of the file and playing the file through a suitable player which supports AVI, MPEG-type, etc., video formats and/or other suitable formats.

P:\PUBLIC\PATENT\BIERNSTER\5865-3.APP



**NON-PROVISIONAL PATENT FILING U.S. 09,587,734 BY FOLEY AND
LARDNER UNDER SUPERVISION OF RESPONDENT THE EVIDENCE OF
WHICH IS ATTESTED TO BY SECTION 3.A. ABOVE AND EXHIBIT E IN
COLLUSION WITH MR. UTLEY**

57103/116

UNITED STATES PATENT APPLICATION

for

SYSTEM AND METHOD FOR PROVIDING

AN ENHANCED DIGITAL VIDEO FILE

Inventors: Eliot I. Bernstein
500 S.E. Mizner Boulevard
Boca Raton, FL 33432-6080
Citizenship: U.S.

Brian G. Utley
1930 SW 8th Street
Boca Raton, FL 33486
Citizenship: U.S.

Jude R. Rosario
5580 NW 61 Street
Apt #625
Coconut Creek, FL 33073
Citizenship: Bangladesh

FOLEY & LARDNER
Attorneys at Law
777 E. Wisconsin Avenue
Milwaukee, Wisconsin 53202
(414) 271-2400

TITLE OF THE INVENTION

SYSTEM AND METHOD FOR PROVIDING AN
ENHANCED DIGITAL VIDEO FILE

CROSS-REFERENCE TO RELATED APPLICATIONS

This application claims the benefit of U.S. Provisional
Application No. 60/137,297, filed June 3, 1999, U.S. Provisional
Application No. 60/155,404, filed September 22, 1999, U.S.
5 Provisional Application No. 60/169,559, filed December 8, 1999,
and PCT International Application No. _____, filed June 2,
2000.

FIELD OF THE INVENTION

The present invention relates generally to video
10 imaging. More specifically, the present invention relates to a system
and method for providing high quality digital video files for streaming
across a network.

BACKGROUND OF THE INVENTION

Streaming video is a technique by which video is played
15 in real time as it is downloaded over the Internet, as opposed to
storing it in a local file first. A video player decompresses and plays
the data as it is transferred to a user computer over the World-Wide
Web. Streaming video avoids the delay entailed in downloading an
entire file and then playing it with a plug-in application. Streaming
20 video requires a communications connection (e.g., a network,
Internet, etc.) and a computer powerful enough to execute the
decompression algorithm in real time.

In the field of streaming video, the primary design challenge is that the viewer desires perfect video quality over a limited-bandwidth network. Perfect video quality requires an enormous amount of digital data. Today's networks are not capable
5 of providing life-like, full motion, full screen streaming video.

It is known to capture video using a capture device, compress the resulting captured video, store the compressed video, and send the compressed video across the Internet. However, prior attempts have failed to produce high quality streaming video that
10 can be transmitted over the Internet. For example, prior attempts at streaming video have been unable to produce full-screen, real video frame rate video at any acceptable quality.

Several teachings have emerged that attempt to improve the quality and decrease the file size of streaming video.
15 One teaching in the art is to reduce the number of frames per second that are being encoded, from the 25 to 30 fps of standard television to 6 or 7 fps or less for streaming video. While this reduces the amount of data that is being sent, the video appears jittery and corresponding voice appears asynchronous with the jittery video.
20 Another teaching in the art is to capture the video at a small frame size of 160 x 120 or less. The small frame size of 160 x 120 is the widely used standard in Internet streaming video. Further teachings are directed to reducing the amount of data that is provided prior to compressing to reduce the file size resulting from compression.
25 Other teachings in the art have pointed toward compressing a digital video file as much as possible prior to transmission. Full-screen, full-motion video has historically been viewed as requiring far too much data for transmission over a limited-bandwidth network.

Accordingly, there is a need for an improved system and method for providing an enhanced digital video file for streaming across a network. Further, there is a need for a digital video file having high quality at various screen sizes with minimal quality loss when the video is expanded to full screen size. Further still, there is a need for a digital video file having a real video frame rate that can be streamed across a limited bandwidth network, such as the Internet. Further yet, there is a need for a video transmission which, once commenced, need not be stopped.

10 BRIEF SUMMARY OF THE INVENTION

According to an exemplary embodiment, a method of providing a streaming video file includes providing digital video data having a capture frame size of at least 69,300 pixels per frame and converting the digital video data to a streaming video file having a converted frame size of at least 69,300 pixels per frame.

According to another exemplary embodiment, a method of providing a streaming video file includes providing digital video data having a capture frame rate of at least 24 frames per second and converting the digital video data to a streaming video file having a converted frame rate of at least 24 frames per second.

According to yet another exemplary embodiment, a method of providing a streaming video file includes obtaining a source video signal having a predetermined source video parameter; capturing the source video signal while maintaining substantially the same source video parameter to provide a captured digital video file; and encoding the captured digital video file while maintaining substantially the same source video parameter to provide a streaming video file.

According to still another exemplary embodiment, a method of generating a streaming video file for streaming over the Internet includes providing digital video data having a capture frame size of at least 320 x 240 pixels; compressing the digital video; data; encoding the digital video data into a streaming video file, wherein the streaming video file has a frame size of at least 320 x 240 pixels; uploading the streaming video file to an Internet server.

According to still another exemplary embodiment, a system for providing a streaming video file includes means for providing digital video data having a capture frame size of at least 320 x 240 pixels and means for converting the digital video data to a streaming video file having a converted frame size of at least 320 x 240 pixels.

According to still another exemplary embodiment, a system for providing a streaming video file includes means for providing digital video data having a capture frame rate of at least 24 frames per second and means for converting the digital video data to a streaming video file having a converted frame rate of at least 24 frames per second.

BRIEF DESCRIPTION OF THE DRAWINGS

The invention will become more fully understood from the following detailed description, taken in conjunction with the accompanying drawings, wherein like reference numerals refer to like parts, in which:

FIG. 1 is a block diagram of a system for generating an enhanced digital video file according to an exemplary embodiment;

FIG. 2 is a flowchart of a method for generating an enhanced digital video file according to the exemplary embodiment of FIG. 1; and

FIG. 3 is a block diagram of a system for playing a digital video file across a network.

DETAILED DESCRIPTION OF THE INVENTION

Referring to FIG. 1, a system 10 for generating an enhanced digital video file is shown. System 10 may be used as shown, or portions of system 10 may be integrated with other video processing systems, such as medical imaging equipment, motion picture production equipment, etc. System 10 generates a digital video file expandable to a full screen size and having a real video frame rate (i.e., life-like, smooth, not jerky, comparable with recorded video formats, such as, NTSC (National Television Standards Committee) at 29.97 frames per second (fps), PAL (Phase Alternative Line) at 25 fps, and SECAM (Séquentiel Couleur Avec Mémoire) at 25 fps)) with a file size that is suitable for streaming over the Internet, for such uses as high definition television, Web television, computers and servers utilized in wireless environments, etc.

As known in the art, video is recorded having certain standard recorded video parameters, such as, frame rate, and number of lines scanned. For example, it is will known that a source conforming to the NTSC (National Television Standards Committee) standard operates at 29.97 frames per second (fps), a source conforming to the PAL (Phase Alternative Line) standard operates at 25 fps, and a source conforming to the SECAM (Séquentiel Couleur Avec Mémoire) standard operates at 25 fps. It is will known in the

art that the NTSC standard includes two interleaved frames at 240 lines scanned, while the PAL standard is 270 lines scanned. Note that the number of lines scanned corresponds to the number of vertical pixels in a standard 320 x 240 frame size compatible with standard capture cards, such as, a Dazzle LAV-1000S capture device manufactured by Dazzle, Inc. of Fremont, California.

System 10 includes one or more sources, including recording devices 12 or playback device 25, a capture device 14, a computer 16, and a network server 18. Recording devices 12 include a camcorder 20, a digital video camera 22, and a reel-to-reel camera 24, each of which may be hand-held or mounted on a tripod or stand. System 10 may include a playback device 25 (e.g., tape player, VHS (Vertical Helix Scan) player, Beta player, DVD (Digital Versatile Disk) player, etc.). Camcorder 20 may be a VHS recorder, Beta recorder, or other camcorder, and is configured to store video on magnetic tape. Digital video camera 22 may be any type of digital video camera configured to generate video in a digital format. In this exemplary embodiment, digital video camera 22 stores the digital video data to a tape. Digital video camera 22 is configured to provide digital video data in real time or via the tape in a digital format, such as, Beta digital, AVI, MOV, MPEG (Motion Picture Experts Group), or other format compatible with the IEEE 1394 standard, etc., to capture device 14. AVI is an audio/video standard designed by Microsoft Corp., Redmond, Washington. According to one exemplary embodiment, a digital video camera including 3CCD technology is used to record the video. The 3CCD technology (3-chip charge-coupled device) includes a dichroic prism and three CCDs, each CCD being aligned to detect only the red, green, or blue color. A 3CCD camera will provide enhanced color resolution. Reel-

to-reel camera 24 includes recording equipment that uses magnetic tape which must be threaded through the equipment and onto an empty reel. According to one alternative embodiment, a separate audio recording device, such as a microphone, may be utilized in
5 conjunction with recording devices 12, in which embodiment recording devices 12 are used to record only video. Other recording devices may be used, such as, devices optimized for live video-conferencing.

Computer 16 includes a processor, memory, magnetic
10 storage device, input/output devices and circuitry, etc. Computer 16 may include multiple computer at multiple sites, with different portions of the process described hereinafter operating on different computers.

Capture device 14 is coupled to one or more of sources
15 11. Capture device 14 is shown external to computer 16, but may alternatively be an internal capture device coupled within the housing of computer 16 or an internal capture device within the housing of one of recording devices 12 or playback device 25. In this exemplary embodiment, a Dazzle LAV-1000S capture device is
20 utilized, though other capture devices may be used, such as a Pinnacle DC10PLUS or Pinnacle DC30PRO device, both manufactured by Pinnacle Systems, Inc., Mountain View, California, or a MotoDV Mobile capture device, manufactured by Digital Origin, Inc., Mountain View, California. Capture software 26, such as
25 Amigo 2.11, manufactured by Dazzle, Inc. or Adobe Premier 5.1, manufactured by Adobe Systems Inc., San Jose, California, is operable on computer 16 to interface capture device 14 with computer 16. Other capture software may be utilized, such as,

RealProducer G2, manufactured by RealNetworks, Inc., Seattle, Washington.

In conjunction with capture software 26, capture device 14 is configured to receive a video signal from one of recording devices 12 or playback device 25, to digitize the video signal, and to store the video signal as a digital video file. The parameters of the video capture will be discussed below with reference to FIG. 2. The digital video file is an MPEG-1 file in this exemplary embodiment, but may alternatively be generated in other digital video formats, such as, MPEG-2, AVI, etc. Capture device 14 is a combined audio/video capture device, but may alternatively include discrete audio and video capture devices, the audio capture device configured to digitize any audio which corresponds to the video being captured by the video capture device. As a further alternative, audio captured device may be utilized alone without a video capture device. The audio capture device may be, for example, a Montego II device, manufactured by Voyetra Turtle Beach, Inc., Yonkers, New York, and configured to generate a digital audio file in a digital audio format, such as, PCM (Pulse Code Modulation).

Editing software 28 is operable on computer 16. In this exemplary embodiment, Adobe Premier 5.1 is utilized, though other video editing software may be used. Editing software 28 receives the captured digital video file and enables an operator to edit the digital video file by adding or deleting frames, adjusting the color, contrast, and brightness of the frames, etc. The edits are then saved to the digital video file or can be exported to AVI or MOV file types.

Encoding software 30 is operable on computer 16. In this exemplary embodiment, RealProducer G2 is utilized, though

other encoding software may be used. Encoding software 30 receives the edited digital video file and encodes the digital video file into an encoded format, such as, an RM format. Encoding software 30 may also compress the digital video file, if needed, to reduce the size of the digital video file, using a video compression algorithm, such as MPEG-1, MPEG-4, etc.

Markup software 32 is operable on computer 16. In this exemplary embodiment, a hypertext markup language (e.g., HTML, Dynamic HTML, Cold Fusion) is utilized. An operator marks up the encoded digital video file in HTML to prepare the digital video file for uploading to the network server 18. In this exemplary embodiment, a code segment representing a full screen frame size, such as 640 x 480 pixels, is associated with the digital video file in the HTML code. The full screen frame size code segment may alternatively include other screen sizes, such as 800 x 600 pixels, 1024 x 768 pixels, 1280 x 1024 pixels, and 1600 x 1200 pixels. During a subsequent video streaming step, the full screen frame size code segment causes or enables a video player program, such as RealPlayer, manufactured by RealNetworks, Inc., to enlarge the streaming video to a full screen frame size, such as 640 x 480 pixels.

References herein to frame sizes in pixels, such as, 320 x 240 pixels, 640 x 480 pixels, are intended to include equivalent frames sizes thereto. For example, it is known that a frame size of 320 x 240 pixels may include an additional number of unneeded pixels (e.g., which can be as much as 10% of the total pixels) attributed to overscan. Thus, one equivalent to a 320 x 240 pixel frame size is 304 x 228 pixels. As a second example, when rectangular pixels are used, the exact pixel count differs from the

stated frame size. Thus, one equivalent to a 320 x 240 pixel frame size is 352 x 240. Accordingly, references to frame sizes in pixels are intended to include these and other equivalent frame sizes, and the teachings herein include any and all such insubstantial variations.

5 The uploading process utilizes uploading software 33, such as, a Web FTP (file transfer protocol) software (e.g., WS FTP PRO, manufactured by Ipswitch, Inc., Lexington, Massachusetts.) The digital video file is uploaded to network server 18, which includes a computer configured to generate a web page on an
10 internet-protocol network, such as the Internet or a company-wide intranet. A web page is a block of data written in a markup language, such as HTML, and any related files for scripts and graphics. Network server 18 may alternatively be coupled to a non-internet-protocol network, such as, an ethernet, a local area
15 network, a wide area network, a wireless network, etc.

 A user computer 34 may access the web page provided by network server 18 via a network, such as, the Internet. Upon actuating a user input device (e.g., a web page button, hypertext link, etc.) associated with the uploaded digital video file, the HTML
20 code launches a suitable video player program (e.g., RealPlayer) at user computer 34, activates the full screen frame size at user computer 34, and streams the video from the digital video file to user computer 34. Alternatively, the video player program may initially play the streaming video at a smaller frame size (e.g., 320 x
25 240), and the user may actuate a user input device on the video player to enlarge the streaming video to a full-screen size, such as 640 x 480. Notably, capture software 26, editing software 28, encoding software 30, markup software 32, and uploading software

33 may be operable on one computer or on different computers during different steps in the process.

According to one alternative embodiment, the encoded digital video file is stored directly to a storage device, such as, a compact disk, a digital video disk, a magnetic storage device, etc., for subsequent viewing on another computer, on a personal digital assistant (e.g., a Palm Pilot manufactured by Palm, Inc., Santa Clara, California), etc. According to another alternative embodiment, digital video data is provided on a storage device (e.g., a floppy disk, a hard disk storage, etc.) which has been pre-captured. The pre-captured digital video data is provided in a compressed or uncompressed digital video format to encoding software 30 for subsequent processing.

Referring now to FIG. 2, a method 50 for generating an enhanced digital video file according to the exemplary embodiment of FIG. 1 is shown. Method 50 is operable using one or more of the elements of system 10, as needed. While the steps of method 50 are explained with reference to captured video, it is understood that captured audio may be processed along with the captured video, or perhaps processed independently in a similar manner. As will be seen, the recorded video will be captured and encoded at near-optimal levels, as determined by the selected parameters in these processes, thereby preserving the highest quality video content. While exemplary values are presented herein for such parameters, it is understood that one of ordinary skill in the art will recognize other combinations of parameters based on these teachings.

According to one exemplary embodiment, a customer provides pre-recorded video saved to a disk or other storage device. At step 52, if the video has been pre-recorded by the customer, the

method proceeds to step 58. If the video has not yet been recorded, at step 54, video is recorded using one or more of recording devices 12 or playback device 25. The video is recorded into any suitable format, such as, VHS or Beta, and is played back using a television standard, such as, NTSC (National Television Standards Committee), PAL (Phase Alternative Line), SECAM (Séquentiel Couleur Avec Mémoire), a digital format, such as, AVI, MOV, MPEG, a digital format compatible with the IEEE 1394 standard, or another format, etc. At step 56, the video is captured by coupling one of recording devices 12 or playback device 25 to capture device 14, which is an external Dazzle LAV-1000 capture device in this exemplary embodiment, but may alternatively be an internal card or other capture devices, such as a Pinnacle DC10 device.

Capture software is also utilized, such as, Amigo 2.11, Adobe Premier 5.1 or Real Producer G2. Capture device 14 and capture software 26 generate a digital video file based on the recorded video. If the recorded video is in an analog format, capture device 14 digitizes the analog video to create digital video data. If the recorded video is in a digital format, capture device 14 merely receives the digital video data and formats a file in the appropriate standard (e.g., AVI, MOV, MPEG1, etc.). According to one exemplary embodiment, capture software 26 is set for real video capture, i.e., having a frame rate of a television or movie standard, such as, 29.97 frames per second. Real video capture may further have a frame rate of between 24 and 30 frames per second, or at least substantially more than the 6 to 9 frames per second conventionally used in streaming video applications. Further, the video is captured with at least approximately 76,800 pixels per frame (at least approximately 69,000 pixels taking into consideration

overscan). For a 4:3 aspect ratio, the frame size of the video capture is at least 320 x 240 in this exemplary embodiment (at least 304 x 228 taking into consideration overscan), or at least more than the 160 x 120 used in conventional streaming video applications.

5 Frame sizes of 480 x 320 and 640 x 480 may also be utilized in the video capture. However, particularly advantageous results are associated with the 320 x 240 capture frame size.

In an alternative embodiment, a separate audio capture device is utilized in parallel with the video capture device. In the
10 alternative embodiment, corresponding audio capture software is operable on computer 16 to digitize the audio into a digital audio format, such as PCM. The sampling rate is between 44 and 48 kiloHertz (kHz); the bus size is 16-bit, allowing an audio resolution of 16-bits; and the audio is sampled in stereo. These parameters may
15 also be set using the video capture software in an embodiment wherein video and audio are captured using one capture device.

The captured video data may be stored as a data file in a storage device (e.g., a hard drive) or may be stored in memory and fed directly to an encoder. The captured video data may further be
20 compressed, for example, to an MPEG-1 file before being saved to the storage device.

At step 58, the digital video file is edited using a video editing software, such as, Adobe Premier 5.1. Adobe Premier 5.1 generates an output file in a MOV or AVI format, but may
25 alternatively generate an output file in any digital video format. The edited digital video file may be stored in the storage device. Step 58 is optional but, if included, preferably Adobe Premier 5.1 maintains a frame size of at least 320 x 240 pixels and a real video frame rate.

At step 60, the edited digital video file is converted or encoded using a video encoding algorithm to create a streaming video file. The edited digital video file is first retrieved from the storage device (unless the digital video data is provided directly from capture device 14). In this exemplary embodiment, the digital video file is encoded to a RealMedia format (i.e., RM) using a RealNetworks encoding algorithm. RM is an audiovisual file format proprietary to RealNetworks, Inc. As a further alternative, Windows Media Encoder, manufactured by Microsoft Corp., may be utilized to encode the captured digital video file, for example, to an ASF format (Advanced Streaming Format) or ASX format. Further still, QuickTime, manufactured by Apple Computer, Inc., Cupertino, California, may be utilized to encode the captured digital video file, for example, to an MOV format.

Encoding may additionally include compression, if a smaller file size is desirable, as indicated by steps 62 and 64. The amount of compression may be selected by the operator using encoding software 30 or alternative compression software. During the encoding process, the digital video file is encoded to have a data rate of between approximately 35 kbps (kilobits per second) to 750 kbps, and a frame rate of between approximately 24 fps (frames per second) and 30 fps (e.g. 29.97 fps.). The number of pixels per frame is set to at least approximately 76,800 (again, at least approximately 69,000 pixels taking into consideration overscan) which, for a 4:3 aspect ratio, is 320 x 240 pixels (again, at least 304 x 228 pixels taking into consideration overscan), or at least more than the 160 x 120 pixels of conventional usage. However, editing, encoding, and compression are optional steps.

At step 66, the digital video file is marked up with a markup language, such as, HTML. At step 68, a full screen frame size is associated with the digital video file. A full screen frame size is at least 640 x 480 pixels, and may also be 800 x 600 pixels, 5 1024 x 768 pixels, 1280 x 1024 pixels, 1600 x 1200 pixels, etc. In this exemplary embodiment, the markup language associated with the digital video file includes a code segment that causes the digital video file to stream at the desired full screen frame size. While the markup language is used to associate the full screen frame size code segment with the digital video file in this exemplary embodiment, the 10 full screen frame size code segment may be associated with the digital video file in another step of the method, such as the encode step 60, compression step 62, or another step.

At step 70, the digital video file is uploaded to an 15 Internet web page using uploading software, such as, WS FTP PRO. At step 72, a script (e.g., an ASCII file (American Standard Code for Information Interchange)) is associated with the marked-up digital video file. The script calls the video to stream in response to a user actuation from user computer 34. The script is written in a RAM 20 format, such as from a Microsoft Notepad software program. The script is included in the markup language associated with the digital video file. In this exemplary embodiment, an actuatable user input device (e.g., a hypertext link) is associated with the HTML code.

Thus, a user from anywhere in the world may access 25 network server 18 via the Internet, actuate the user input device, and call the video to stream. Upon actuation, the HTML codes launch video playing software (e.g., RealPlayer) at the user computer, enlarge the viewing window of the software to full screen mode (i.e., at least 640 x 480), and begin streaming the video to the

user computer. Alternatively, the user may expand the viewing screen to full screen mode by actuating an input device on the video player software. Other methods of expanding the viewing screen to a full screen are contemplated. The transmission speed of the digital video file is dependent upon the bandwidth of the user's network connection, but may range from approximately 35 kbps to 750 kbps, or as low as 28.8 kbps, with a frame rate of between approximately 24 fps to 29.97 or 30 fps.

According to one alternative embodiment, network server 18 is configured to query user computer 34 to ascertain the network connection used by computer 34 (e.g., 28.8 kbps modem, T1 line, ISDN, etc.). Thereafter, network server 18 determines the appropriate transmission rate based on the ascertained network connection.

15

EXAMPLE A

A Sony DCR VX-1000 digital video camera, having 3CCD technology, manufactured by Sony Electronics, Inc., Park Ridge, N.J., was utilized to record a video signal. The video camera generated an output signal of 6MHz in NTSC format.

A Dazzle LAV-1000S external capture device was coupled to the video camera. Amigo 2.11, Dazzle's capture software was used. The Dazzle capture device and capture software were programmed with several parameters. The frame size was left at the default setting of 320 x 240 pixels. The frame speed was set to 29.97 frames per second. The bit rate was set to 3.0 Megabits (Mb) per second. The audio capture was set to 44 kHz, 16 bit sampling rate. An MPEG-1 file was generated based on the video

signal using the capture device and software programmed with these parameters.

When the captured MPEG-1 file was provided to RealEncoder G2, the resulting encoded file failed to retain the real video frame rate. Therefore, Adobe Premier 5.1 was utilized to receive the MPEG-1 file and export it to a MOV or AVI or MPEG file., based on several parameters. The frame rate in Adobe Premier 5.1 was set to 29.97 fps. The frame size was set to 320 x 240. The "Quality" setting, representing the number of colors to appear in the edited file, was set to a high setting (e.g., 100%). Adobe Premier 5.1 generated an AVI file or an MOV file or a MPEG file, depending upon the operator selection.

RealEncoder G2 software was used to encode the AVI or MOV file into a streaming video file in RM format. The RealEncoder G2 software was programmed with several parameters. The bitrate was set to 220 kbps. The frame rate was set to 30 fps. The "Surestream" option was selected. "Surestream" technology adjusts the playing speed of the encoded digital video file to accommodate the network connection speed of the user. For sound quality, "stereo/music", the highest quality, was selected. For image quality, "sharpest image", the highest quality, was selected. Regarding frame size, this version of RealEncoder generated an output signal having a frame size equal to that of the frame size of the MOV or AVI input file. RealEncoder compressed the MOV or AVI input file using the RealNetworks compression algorithm. An RM file was generated based on the these parameters.

The RM file was uploaded to an Internet server. Using Microsoft Notepad, a script was written in RAM format to 1) identify the location of the RM file, 2) launch RealPlayer on the user

computer, 3) resize the viewing screen on the user computer to 640 x 480, and 4) begin the video stream. The result was unexpectedly high-quality, full-screen, real video frame rate, streaming video. The RM file was subsequently streamed to a client computer via a
5 telephone modem and via other broadband connections. The same unexpectedly high-quality, full-screen, real video frame rate, streaming video was experienced. The streaming playback was intermittent due to the need to buffer to accommodate the lower bit-rate of transmission.

10

EXAMPLE B

According to another example, an NTSC analog signal is provided to a Pinnacle DC-10PLUS capture device. The Pinnacle
15 capture device and associated software generate a digital video file in AVI format based on several parameters. The capture type is set to NTSC. The frame size is set to 320 x 240 pixels, or "1/4 full frame size". Brightness, sharpness, and color are adjusted, as desired. The compression rate is set to 2.5:1. The frame rate is set
20 to 29.97. Square pixel ratio is selected. Audio is set to stereo format, 44 kHz, 16 bit sampling. The data rate is set to 1739 kbps. The capture device utilizes a Miro codec to create a digital video file in AVI format.

Optionally, a header and footer is provided to the
25 beginning and end of the digital video file. The header and footer include a trademark for the assignee of the present application. Adobe Premier is used to render the header, footer, and watermark to the digital video file. A parameter within Adobe Premier is set to

a frame size of 320 x 240. Adobe Premier further utilizes a Miro codec to create a digital video file in AVI format.

The edited AVI file is encoded by RealProducer software. The following parameters are programmed in the RealProducer software. One set of parameters was used for a low-speed network connection at the user computer (hereinafter designated "LO"), and another set of parameters was used for a high-speed network connection at the user computer (hereinafter designated "HI"). RealNetworks "Surestream" technology is selected. Alternatively, "single-stream" can be selected, and an RAM file can be generated to query the connection speed of the user computer and stream the video at the proper connection speed. The encoding speed is set to, for LO, 28 kbps or 56 kbps, and for HI, LAN, DSL, Cable Modem, or T1. Sound quality is set to "voice only" or "stereo music" or "CD quality". Video quality is set to "sharper image". Frame rate is set to 29.97 fps. Target bit rate is set to 350 kbps. The target player is specified as RealPlayer G2. Frame size is set to 320 x 240. Based on these parameters, the RealEncoder software generates an RM file or other streaming video data file, which is subsequently uploaded to RealServer.

The exemplary embodiments disclosed herein provide greatly enhanced streaming video suitable for streaming over a limited-bandwidth network, such as the Internet. Several discoveries have enabled various aspects of this technology. The first discovery was that the efficiency of encoding from a captured digital video file to a streaming video file is increased with an increase in the frame size of the captured digital video file. Thus, while conventional teachings pointed toward minimizing the capturing and encoding

frame sizes (typically to 160 x 120 pixels, which has widely become an Internet standard for streaming video) to reduce the size of the resulting file, the present inventors turned away from these teachings and increased the capturing and encoding frame sizes to 320 x 240 pixels. Second, one goal of the present inventors was to achieve full-screen, real video frame rate, streaming video. Conventional teachings would point toward encoding at a frame size of 640 x 480 pixels to achieve full-screen streaming video. However, with today's technology, enlarging the frame size of a captured digital video file during encoding to 640 x 480 (for example, from 160 x 120 pixels) pixels causes an enormous increase in the amount of data in the resulting encoded digital video file and requires enormous bandwidth to stream. Therefore, the present inventors discovered that encoding at 320 x 240 pixels (or its equivalent) provided greatly improved results when doubled to full-screen for viewing.

These conventional teachings were evidenced in the capabilities of the encoder used at the time of invention, namely, RealProducer G2. RealProducer G2 taught away from real video streaming since digital video files that were captured at a real video frame rate (e.g., 30 fps) would be automatically reduced to a lower, non-real video frame rate (e.g., 15 fps) to reduce the size of the streaming video file. Furthermore, digital video files which were captured directly from a capture device using RealProducer G2 were encoded at a frame rate of only 6-7 fps and had no option to adjust frame size. Therefore, to obtain a real video frame rate, the inventors followed the steps in EXAMPLE A above to achieve the first high quality, full-screen, real frame rate streaming video file.

Referring now to FIG. 3, a system 80 for playing a digital video file across a network is shown, and a corresponding method is described. System 80 includes a network server 82 having a processor 84, a storage device 86, and a network interface 88. A capture device 90 is coupled to network server 82 and is configured to capture a video signal, as described hereinabove. Processor 84 controls capture device 90 and provides various parameters to capture device 90 regarding frame size, bit rate, etc. For example, one or more of the methods for capturing video and generating a digital video file described hereinabove may be implemented by processor 84, storage device 86, and capture device 90. Processor 84 and capture device 90 generate a digital video file in a digital video format (e.g., MPEG, AVI, etc.) and store it to storage device 86. As used in this description of FIG. 3, the term "storage device" includes such devices as magnetic tape, a hard drive, a floppy disk, magnetic disk, or other similar non-volatile storage media, but not including random access memory or other temporary memory. The capture process may alternatively be carried out on another computer, after which the resulting digital video file is stored in (e.g., uploaded to) storage device 86.

Network server 82 is coupled through network interface 88 to a network 92, such as the Internet, a LAN, etc. Processor 84 is configured to generate a web page having a hypertext link to the digital video file stored in storage device 86. A network client 94 includes a processor 96, a storage device 98, an input device 100, a display 102, and a network interface 104. Network client 94 is operable via a user to access the web page generated by network server 82 and to actuate the hypertext link to begin downloading the digital video file from storage device 86.

One drawback of downloading video files is that, for very large files, the delay before any portion of the digital video file can be viewed can be on the order of minutes, hours, or longer. Thus, according to one advantageous aspect of system 80, while
5 the digital video file is being downloaded to network client 94 and stored in storage device 98, some of the digital video file which has already been downloaded and stored is being simultaneously played on display 102. A suitable player which supports AVI, MPEG, and other digital video formats is utilized for the video play. This
10 procedure may be referred to as viewing/downloading. Stated another way, a first portion of the digital video file is played from storage device 98 while later portions of the digital video file are still downloading from storage device 86 via network 92 to storage device 98.

15 One method of launching the player and beginning the play of the first portion is for a user to simply select these steps via input device 100 (e.g., a mouse, a keyboard, etc.) a certain time after the downloading has begun. Alternatively, an algorithm may be provided, either attached to the digital video file (e.g., HTML, Java, a
20 macro, etc.) or as part of the player (e.g., QuickTime, RealPlayer, etc.) which begins playing the digital video file at a predetermined time after the download to storage device 98 has begun. This predetermined time may be pre-programmed or adjusted in real-time based on inputs from client server 94 or network server 82.
25 According to one example, the algorithm calculates the predetermined time based on the download speed (e.g., including network connection speed of network interface 104, etc.), the viewing speed (e.g., frames per second, etc.), and the size of the digital video file. For example, if the viewing speed is four times the

download speed, the algorithm monitors the amount of the file (e.g., in bytes) which is downloaded until 75% of the file is downloaded. When 75% of the file is downloaded, the algorithm begins playing the digital video file from storage device 98. By playing the file at this predetermined time, the digital video file will play substantially without delays for buffering. Of course, other predetermined times are contemplated, including those earlier and later than that set forth in this exemplary embodiment.

Thus, one can view a digital video file shortly after clicking on the hypertext link and before the entire digital video file has downloaded to storage device 98. Once the entire digital video file is finished playing, network client 94 retains a copy of the digital video file in storage device 98 for later playing.

According to one alternative, the digital video data is captured in real-time and streamed in real-time across network 92 (i.e., without first storing to storage device 86) to storage device 98.

While the embodiments and applications of the invention illustrated in the FIGS. and described above are presently preferred, it should be understood that these embodiments are offered by way of example only. For example, while the steps of the exemplary embodiments contemplate recording audio and video at one time and streaming the audio and video at another time, the audio and video may alternatively be fed through system 10 in real-time, thereby facilitating real-time audio/video transmissions. Furthermore, the exemplary software programs mentioned may be replaced by newly developed versions and/or programs in the future. Accordingly, the present invention is not limited to a particular embodiment, but extends to various modifications that nevertheless fall within the scope of the appended claims.

WHAT IS CLAIMED IS:

- 1 1. A method of providing a streaming video file,
2 comprising:
3 providing digital video data having a capture frame size
4 of at least 69,300 pixels per frame; and
5 converting the digital video data to a streaming video
6 file having a converted frame size of at least 69,300 pixels per
7 frame.

- 1 2. The method of claim 1, wherein the capture frame size
2 has an aspect ratio of 4:3 and the converted frame size of has an
3 aspect ratio of 4:3.

- 1 3. The method of claim 2, wherein the capture frame size
2 is at least 304 x 228 pixels and the converted frame size is at least
3 304 x 228 pixels.

- 1 4. The method of claim 3, wherein the capture frame size
2 is approximately 320 x 240 pixels and the converted frame size is
3 approximately 320 x 240 pixels.

- 1 5. The method of claim 1, wherein the step of providing
2 includes capturing a video signal.

- 1 6. The method of claim 5, wherein the step of providing
2 includes digitizing the video signal to generate the digital video data.

1 7. The method of claim 6, wherein the step of providing
2 includes storing the captured video data as a data file in a storage
3 device, and wherein the step of converting includes retrieving the
4 stored data file from the storage device.

1 8. The method of claim 1, wherein the step of providing
2 includes retrieving the digital video data from a storage device.

1 9. The method of claim 1, further comprising compressing
2 the digital video data.

1 10. The method of claim 9, wherein the digital video data is
2 compressed to an MPEG file format.

1 11. The method of claim 1, wherein the streaming video file
2 is converted to an RM format or an ASF format.

1 12. The method of claim 1, wherein the converted frame
2 size is approximately 320 x 240 pixels.

1 13. The method of claim 1, wherein the digital video data
2 has a capture frame rate of at least 24 frames per second and the
3 streaming video file has a converted frame rate of at least 24 frames
4 per second.

1 14. The method of claim 1, further comprising streaming
2 the streaming video file across a network.

1 15. The method of claim 14, wherein the network is the
2 Internet.

1 16. A method of providing a streaming video file,
2 comprising:
3 providing digital video data having a capture frame rate
4 of at least 24 frames per second; and
5 converting the digital video data to a streaming video
6 file having a converted frame rate of at least 24 frames per second.

1 17. The method of claim 16, wherein the capture frame rate
2 is between 29 and 30 frames per second and the converted frame
3 rate is between 29 and 30 frames per second.

1 18. The method of claim 16, wherein the step of providing
2 includes capturing a video signal.

1 19. The method of claim 17, wherein the step of providing
2 includes digitizing the video signal to generate the digital video data.

1 20. The method of claim 18, wherein the step of providing
2 includes storing the captured video data as a data file in a storage
3 device, and wherein the step of converting includes retrieving the
4 stored data file from the storage device.

1 21. The method of claim 16, wherein the step of providing
2 includes retrieving the digital video data from a storage device.

1 22. The method of claim 16, further comprising
2 compressing the digital video data.

1 23. The method of claim 21, wherein the digital video data
2 is compressed to an MPEG file format.

1 24. The method of claim 16, wherein the streaming video
2 file is converted to an RM format or an ASF format.

1 25. The method of claim 16, wherein the digital video data
2 has a capture frame size of at least 69,300 pixels per frame and the
3 streaming video file has a converted frame size of at least 69,300
4 pixels per frame.

1 26. The method of claim 25, wherein the capture frame size
2 has an aspect ratio of 4:3 and the converted frame size has an
3 aspect ratio of 4:3.

1 27. The method of claim 26, wherein the capture frame size
2 is at least 302 x 228 pixels and the converted frame size is at least
3 302 x 228 pixels.

1 28. The method of claim 27, wherein the capture frame size
2 is approximately 320 x 240 and the converted frame size is
3 approximately 320 x 240 pixels.

1 29. The method of claim 16, further comprising streaming
2 the streaming video file across a network.

1 30. The method of claim 29, wherein the network is the
2 Internet.

1 31. A method of providing a streaming video file,
2 comprising:
3 obtaining a source video signal having a predetermined
4 source video parameter;
5 capturing the source video signal while maintaining
6 substantially the same source video parameter to provide a captured
7 digital video file; and
8 encoding the captured digital video file while
9 maintaining substantially the same source video parameter to provide
10 a streaming video file.

1 32. The method of claim 31, wherein the source video
2 parameter includes the frame rate.

3 33. The method of claim 32, wherein the source video
4 frame rate is at least 24 frames per second.

5 34. The method of claim 32, wherein the source video
6 frame rate is a real video frame rate.

7 35. The method of claim 31, wherein the source video
8 parameter includes the number of scanned lines of video per frame.

9 36. The method of claim 35, wherein the number of
10 scanned lines of video per frame is at least 240.

11 37. The method of claim 31, wherein the streaming video
12 file has a capture frame size of at least 304 x 228 pixels.

1 38. The method of claim 37, wherein the streaming video
2 file has a capture frame size is approximately 320 x 240 pixels.

1 39. The method of claim 31, further comprising editing the
2 captured digital video file using video editing software.

1 40. The method of claim 31, wherein the step of encoding
2 includes compressing the captured digital video file.

1 41. The method of claim 31, wherein the captured digital
2 video file is in an MPEG file format.

1 42. The method of claim 31, wherein the source video
2 signal is provided from a video playback device.

1 43. A method of generating a streaming video file for
2 streaming over the Internet, comprising:
3 providing digital video data having a capture frame size
4 of at least 320 x 240 pixels;
5 compressing the digital video data;
6 encoding the digital video data into a streaming video
7 file, wherein the streaming video file has a frame size of at least 320
8 x 240 pixels; and
9 uploading the streaming video file to an Internet server.

1 44. The method of claim 43, wherein the streaming video
2 file has a real video frame rate.

1 45. The method of claim 44, further comprising associating
2 a hypertext link with the streaming video file.

1 46. The method of claim 45, further comprising running a
2 video player program on an Internet client computer.

1 47. The method of claim 46, further comprising configuring
2 the video player program for full-screen streaming video.

1 48. A system for providing a streaming video file,
2 comprising:
3 means for providing digital video data having a capture
4 frame size of at least 320 x 240 pixels; and
5 means for converting the digital video data to a
6 streaming video file having a converted frame size of at least 320 x
7 240 pixels.

1 49. The system of claim 48, wherein the digital video data
2 has a capture frame rate of at least 24 frames per second and the
3 streaming video file has a converted frame rate of at least 24 frames
4 per second.

1 50. The system of claim 48, further comprising means for
2 capturing a video signal.

1 51. The system of claim 48, wherein the means for
2 converting includes means for encoding the digital video file into an
3 RM file format.

1 52. A system for providing a streaming video file,
2 comprising:
3 means for providing digital video data having a capture
4 frame rate of at least 24 frames per second; and
5 means for converting the digital video data to a
6 streaming video file having a converted frame rate of at least 24
7 frames per second.

1 53. The system of claim 52, wherein the capture frame size
2 is at least 302 x 228 pixels and the converted frame size is at least
3 302 x 228 pixels.

1 54. The system of claim 52, further comprising means for
2 capturing a video signal.

1 55. The system of claim 52, wherein the means for
2 converting includes means for encoding the digital video data into an
3 RM file format.

ABSTRACT OF THE DISCLOSURE

A system and method of providing a streaming video file includes providing digital video data having a capture frame size of at least 69,300 pixels per frame and converting the digital video data to a streaming video file having a converted frame size of at least 69,300 pixels per frame. According to another exemplary embodiment, a method of providing a streaming video file includes providing digital video data having a capture frame rate of at least 24 frames per second and converting the digital video data to a streaming video file having a converted frame rate of at least 24 frames per second.

001.793764.1

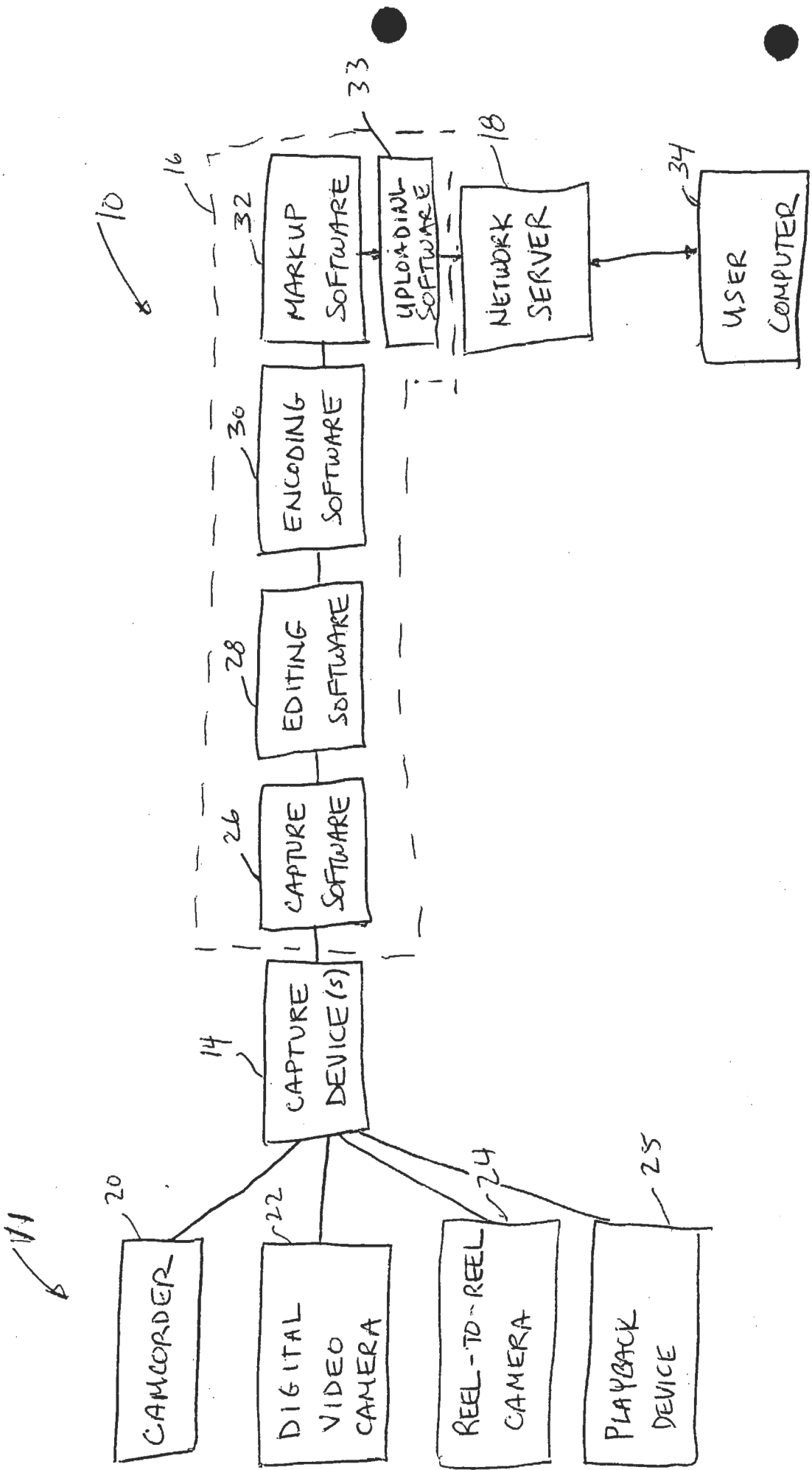
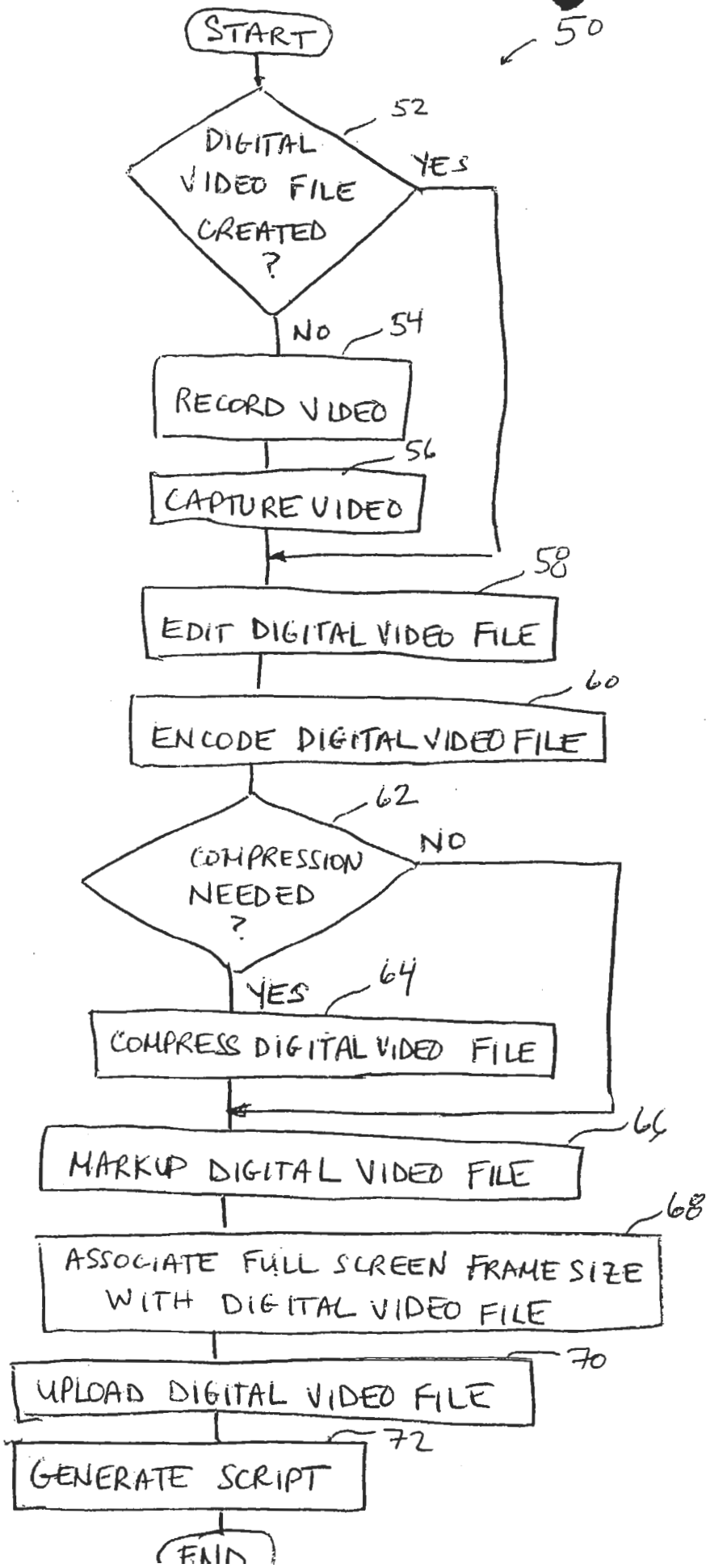

FIG. 1



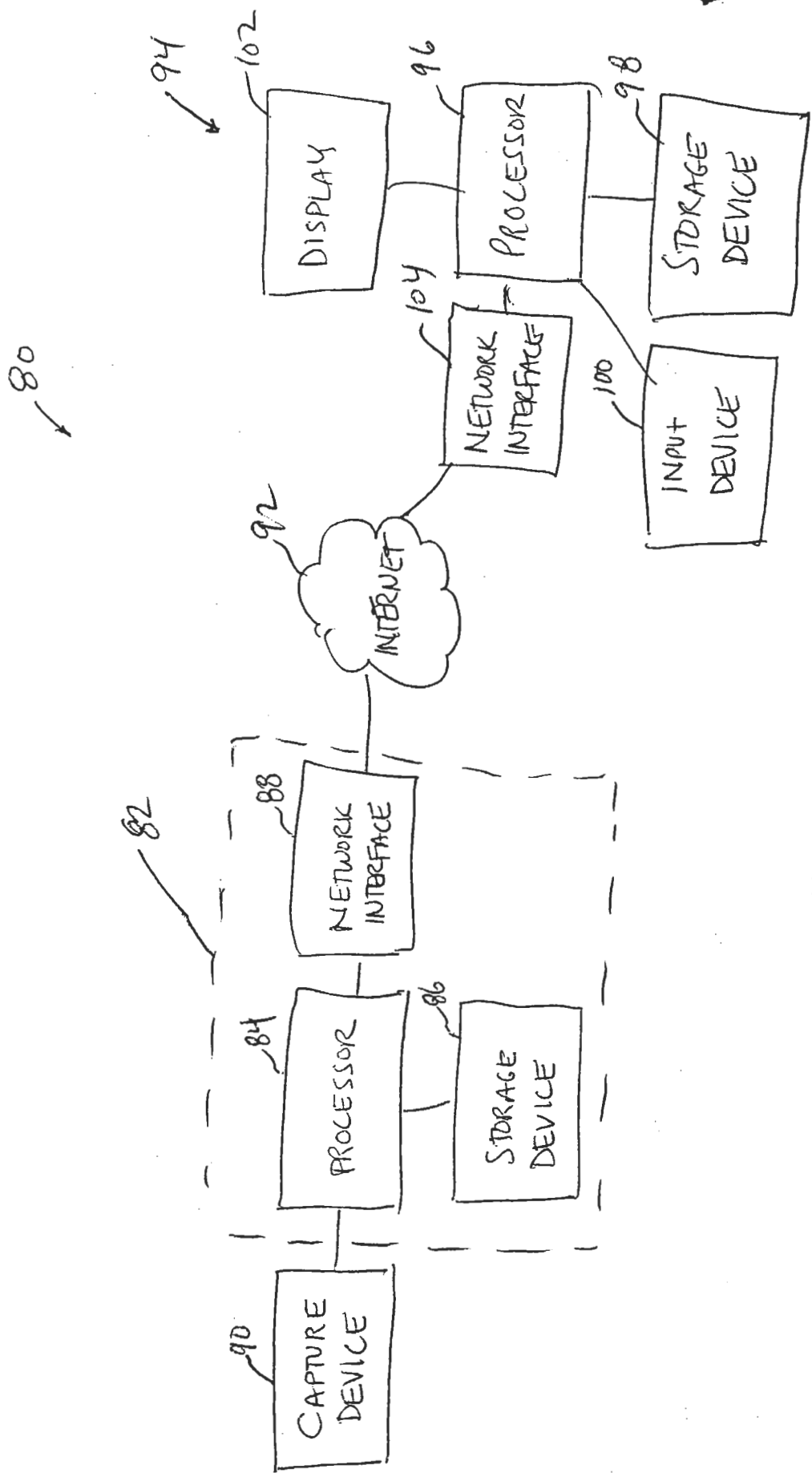

FIG. 3



EXHIBIT K



<u>PARTIAL LIST OF INTRODUCED CLIENTS OF RESPONDENT BREACHING CONFIDENTIALITY AGREEMENTS</u>
Visual Data Corp.
Warner Bros.
AOL Time Warner
Deutsche Telekom
Boca Research
Intel Corp. (acquired Real 3D)
SGI, Inc. (prior to Intel's acquisition of Real 3D)
Lockheed Martin Corp (prior to Intel's acquisition of Real 3D)
Eclipsys Corp.
SONY
Viacom
Blockbuster
Citrix Systems
Columbia/Tri-Star
Disney
Ronald G. Assaf and Sensormatic Electronics Corp.
Teranex



LETTER OF MR. COLTER

Subj:iviewit
Date:1/14/2002 9:51:08 PM Pacific Standard Time
From:David.Colter@warnerbros.com (DColter0264)
To:John.calkins@warnerbros.com
CC:CHuck.dages@warnerbros.com, Alan.Bell@warnerbros.com (ABell0648)
Sent on: AOL 6.0 for Windows US sub 10551

John,

In all the review we have done with iviewit it seems to boil down to the status of the patents and their inherent value. At that point it is a risk-reward evaluation -- without awarded patents it is difficult to completely assess the value. I would suggest that we consider one other perspective...

Prior to iviewit (approx Feb 2000) the video we (WB Online) delivered on the web was QCIF (160x120) or smaller and was below full frame rate. At the time of our first meeting we also identified On2 along with iviewit as two solid players who could deliver full screen full frame rate web video. All who saw it were impressed. Greg and I visited iviewit in August and reported back that they had filed patents on scaling techniques that hinged upon a visual 'trick' which allowed the human eye to accept 320x240 video scaled to 640x480 at 30 fps as close to VHS quality. We checked with Ken Rubenstein and others who provided some solid support for iviewit, and Chris Cookson asked Greg and I to continue to work with iviewit in an R&D capacity.

In the fall of 2000 iviewit also met with a number of folks at WB Online (in September and October) and demonstrated their process and techniques to Sam Smith, Houston, Joe Annino and others. Sam contacted iviewit a number of times and requested the patents, along with specifics of the iviewit process to evaluate what they were doing. I was not part of these meetings, but was aware they had occurred, as Jack Scanlon kept me up to date.

When I sat down with Morgan and Houston in March 2001 to see what technology they were using to encode video, it was clear that they were using some of the techniques that would overlap with iviewit's filed process patents (still pending), but it is not clear that these were all learned from iviewit -- we may wish to explore this a little. This meeting was to determine what equipment we would get for our lab at 611 Brand. This same information was also provided to iviewit by Morgan as they were establishing the company as an outsourcing facility for encoding our content.

I am aware of several meetings held between iviewit and WB Online to share information of techniques and process, and was invited to a few of them.

We all signed iviewit's confidentiality agreement. So to the other perspective....

We have an opportunity to establish a license with iviewit for a modest fee at this time, and establish a MFN. In good faith we signed the confidentiality agreement, iviewit revealed their processes and techniques, and we now use those techniques in encoding. As we have discussed on a few occasions, these techniques now appear in the public domain to some extent in documentation for Real Producer, WMP Developer Guides, Media Cleaner Pro, etc, but they were not available in 2000. I would not suggest we learned the techniques completely from iviewit (I actually do not know the answer), but a modest licensing fee may be appropriate and honorable considering our good faith relationship in signing the confidentiality doc.

If we choose to pass at this time the risk is primarily from iviewit's main investor, Crossbow Ventures, gaining control of the IP and approaching WB later for a license -- I do not believe they will be as friendly considering their dealings with iviewit and its employees since Feb of 2001. It is estimated that the patents will be completed in 8-12 months.



As you are all aware I have a personal relationship with Eliot Bernstein, the founder of iviewit, and as a result, I left the evaluations and decisions to Greg, and others, and only assisted iviewit to get to the correct people in WB and AOLTW. I wanted to add this perspective as we consider if there is an option to pursue with iviewit -- they are facing continued financial pressure right now. There are many other threads to our interaction with iviewit and I would be happy to discuss.

Thanx,
David



EXHIBIT L



**TELECONFERENCE TRANSCRIPT OF
JULY 31, 2000
PARTICIPANTS:**

- **DOUGLAS BOEHM OF FOLEY AND LARDNER;**
- **MR. BERNSTEIN, MR. UTLEY, AND MAURICE BUCHSBAUM OF THE COMPANY;**
- **RESPONDENT OF PROSKAUER**

CORRECTED VERSION - CORRECTED ON 5/14/2003
Transcription of Telephone Conference
Conducted July 31, 2000

Participants:

Simon Bernstein, Eliot Bernstein, Maurice Buchsbaum,
Brian Utley, Doug Boehm, Chris Wheeler

Note: Square brackets [] are used to indicate inaudible or indecipherable text. Text found inside brackets indicates transcriptionist's best guess. Since speaker names are not specifically identified, transcriptionist has made an attempt to identify based upon comments made in conversation but cannot guarantee that each speaker has been accurately identified. Note also that this recording has numerous instances of participants speaking at once or carrying on simultaneous side conversations that make it difficult to follow and transcribe the entire line of discussion.

Utley: <begins midstream>...status of the original digital image filings, and basically the fact that the original filings do not cover the full subject matter of the imaging technology; and to wit, one of the omissions, in particular in reading the claims section of the provisional and the formal filing, relates to the zooming and panning capability that is inherent in the technology. This has become a topic due to the fact that we are currently in the second phase of filing imaging patent protection which is driven by the provisionals that were filed later last year, between August and December of last year. So the concern that were expressed by Eliot in reviewing this is that this omission of the zooming and panning capability was attributable to a failure, for whatever reason, on the part of Ray Joao, the patent attorney of record, in constructing and putting together the provisional and formal filing<tape cuts out here> did I say it is that right Eliot

E Bernstein I believe so

Utley Is that your understanding

E Bernstein Correct

Utley The purpose of this meeting is to review the facts and I think there are two particular points that are ...that are important to moving ahead. The first is: "Given that the filings are what they are, and given what we know about the filing which is scheduled to take place this week on Wednesday, what means do we have to correct the situation; and given whatever corrections we find, what then is the impact or exposure to iviewit based upon what actions we can take. Then, lastly, what, if any, recourse might iviewit have vi sa vi the omissions in the original filings Are there any other issues, Doug?

Bernstein: Yeah, just correcting back to Ray Joao's work of the formal filing that he filed. Do we have a copy of that?

Utley: I do have that.

Bernstein: I don't. I've got the provisional and I've got...

Boehm: Everything is on the table

Utley: you should have...the formal.

Bernstein: This one?

Utley: Yes, that's the formal.

Bernstein: Okay.

Simon Bernstein: I just have one question. Does anybody have, or are we allowed to get, the files of Ray Joao?

Boehm: I have them.

Wheeler: Do you have all of the work that he had?

Bernstein: No, not all of it.

Utley: What was purported to be in the files?

Bernstein: And he also claimed to us that he destroyed part of his files.

Boehm: And I have some of his files. I have what was purported to be all of the firms' files.

<Inaudible comment.>

Utley: Well, there's a whole history, then, because I tried to get complete copies of the files originally, and found out later that not only did he not send us all the files, he didn't even mention that there was an extra filing out there that we didn't even know about.

Bernstein: This one that's in question.

Boehm: Yep

Simon Bernstein: You have no notes, no data on...?

Boehm: No, I have the application. I have things that you could get from the US patent office—that I could get from the US patent office. I have very few notes. I do have some scribbled Ray Joao's notes, but I think you gave me those notes.

Utley: I did. I gave you Bill Dick after Bill yourself[] the notes that I had.

Bernstein: And Ray's made disclosures to us that he destroyed the documents to protect us, which I don't know what he was thinking.

Simon Bernstein: Destroyed what documents?

Bernstein: Whatever he had in his files. Other patent copies, copies of the drafts as they proceeded...all that he destroyed to protect us from something I asked him to explain, and his reasoning...because I said to him, you know, usually you destroy documents when you are protecting somebody from something illegal or something. Have I done something that would force you to hurt me possibly? He said it was typical, normal, that all lawyers destroy their records.

Simon Bernstein: If that, in fact, is the case—I've never heard of a lawyer you know other than Nixon destroying anything the work is ours. Am I right Chris when we pay for a lawyer and we pay for the work, the work is ours.

Wheeler: The work product is yours. He may maintain copies of his files and everything; or his confidential notes to himself are not necessarily yours. But the work "product" is...

Simon Bernstein: Would you say that anything germane to the issue belongs to him?

Wheeler: Well, I mean if he wrote notes...in sidebars...yeah.

Bernstein: How about revised patents[]. How about copies? Works in progress

Wheeler: But things which would reinforce your patent, obviously, that is germane to the strength of your patent yes, you would be entitled to copies I don't think we disagree.

Bernstein: He's claiming He destroyed all faxes.

Wheeler: Can I ask you a question?

Bernstein: Yes.

Wheeler: Just so both of us understand...was this patent done prior to his flying down here, or was this patent done as a result of his flying down here and having discussions with you? I was under the impression that when he flew down here—this was before Brian came—I was under the impression that followed our meeting with Reel 3-D. I was under the impression that he was coming down to discuss, at the very least, the video aspect so that you could complete that; but were you also completing the imaging patent?

Bernstein: Correct.

Wheeler: So he went to your [kitchen]?

Bernstein: Right. And we spent days there

Wheeler: And the two of you spent all the days...

Bernstein: Correct.

Wheeler: And did he, in front of you, write notes?

Bernstein: Tons. Hundreds

Wheeler: And did he then produce them on his computer and type out certain things?

Bernstein: Yes.

Wheeler: I was under the impression he was doing that with you.

Bernstein: He did.

Wheeler: And did you read those?

Bernstein: I did. I did - now going to that same nature, that's the provisional I think we're talking about...

Wheeler: Right.

Bernstein: But he flew out here again with me and Brian and went through this as he went to file this--this is a 3/23/2000 file--that also fails to make mention of.

Wheeler: So that's the formal file...the formal one?

Bernstein: The formal file. So both also missed the point.

Wheeler: I just wanted to know and to put things in proportion, when you read the provisionals, because Brian wasn't with the company right now and then, and when there were all those drafts, because obviously we didn't see them...

Bernstein: Well, you saw because we gave you all the documents. I'd get a document from Ray and bring it to you so you would have records of everything up to that point because I didn't want to keep them at my house.

Wheeler: The final...the final...but I'm not reviewing the patent. I was keep maintaining it as...

Bernstein: Okay, but you have every record...

Wheeler: Everything you gave me we maintain. We don't...

Simon Bernstein: Any notes should be produced...

Wheeler: We don't throw away anything.

Bernstein: Yeah, I know.

Simon Bernstein: I know you don't you're very thorough.

Wheeler: So, I'd file it away; so if you gave it to me, it's in our archives.

Bernstein: Right.

Wheeler: I wanted to know, when you read those drafts...

Bernstein: Oh, it was...it was clear

Wheeler: Answer my question...when you read the drafts, did you see the panning and scanning elements?

Bernstein: Yeah, and zooming, up to 1,000 times we thought it was. That was the big...you know, we had it in there...as a matter of fact, he just said it...somewhere it's in there up to 1,000 times, isn't it?

Utley: 1,700.

Bernstein: Right. That was our old mistaken a number of times. So, yeah, for him to miss that, Chris, would be the essence of stupidity.

Wheeler: So it was in there?

Bernstein: Absolutely.

Utley: The zooming, it was in the body, but not in the claim.

Boehm: But a provisional doesn't really...doesn't have to have claims.

Utley: It doesn't have claims.

Bernstein: But then in our claims of our patent, it's not there. This is what you're representing, correct?

Wheeler: So you're saying that it wasn't put in the file, but it was put in the provisional.

Boehm: No, I could see where he's going to argue that it's there.

Bernstein: Let's see. Let's take a look.

Wheeler: ...what the language of the patent claims are that he filed.

Bernstein: Okay, let's see what he...

Wheeler: And this isn't the final decision because I can go back right now and amend those claims.

Bernstein: Wow, yes, but we have elements of exposure that creep in correct?

Wheeler: I'm just telling you the whole thing, then we'll go back. So you did look it over, and there are no claims in the provisional?

Boehm: There are no claims in a provisional. You can file them, but they are never examined.

Wheeler: But the zooming and the panning and the scanning element was incorporated in that?

Boehm: Go ahead, Brian.

Utley: Let me make sure that we say that properly. The provisional filing had a claims section which migrated into the final filing, but Eliot is correct in saying that the provisional does not need a claims section.

Boehm: The provisional never gets examined, so it doesn't need the claims. It just holds your place in line for one year.

Bernstein: But then when I look through this...

Simon Bernstein: Hold on, Eliot, I need to understand this. What you're saying, then, is assuming any negligence on his part, to that point the negligence doesn't become realistically damaging to the company until since he actually made a claim...since he actually made a provisional filing. Which took our place in line.

Boehm: If the provisional filing covered the invention, your place in line is only as good as the subject matter described in accordance with the law.

Simon: Obviously, it should have had the panning and zooming in there.

Boehm: Well, the word "zoom" is in there.

Bernstein: But not really to describe what we're doing.

Boehm: But do you see what I'm saying? It's only to the amount of subject matter that and attested where the average person skilled in the art could make and use an invention as it's described in this document, and without "undue" experimentation, without inventing it himself.

Simon Bernstein: Right.

Boehm: Now, this provisional application, you throw it...different patent attorneys do different things with it. On one end of the spectrum, you do an invention disclosure. Most big corporations have invention disclosure forms which leads the inventor to write out good disclosures and figures and things, and I've seen people actually file that invention disclosure because if you're coming up on a bar date, you don't have time to write an application or think about what your invention is. All you've got to do is get something on file, and then hope that it will protect...that whatever you had on file covered your invention.

Simon Bernstein: Is that what we've done so far?

Bernstein: No.

Boehm: I don't want to answer that, but that's the line.

Boehm: It's a grey question, it's a grey area, I think.

Wheeler: That's what we're aiming to do, that's what we're hoping to do.

Boehm: But on one end of the spectrum, you file very minimal work, and that's what Ray did on some of the applications, like on the one...

Wheeler: He was trying to do it in a broad...

Wheeler: He did say conceptually that his method was to do a broad stroke of it.

Boehm: Right. Well, a broad stroke on drafting the claims.

Wheeler: Okay. Right.

Eliot Bernstein: He's got to put the invention in!

Boehm: That doesn't happen in a provisional at all, generally. If you want to, you can write the provisional claims just so you know what you're doing, and it's actually used as subject matter; but the claims are never examined. It doesn't matter if it's in proper format or anything, it just sits there. Now, if you pick up the provisional a year later—it has to be within that year—if it's a real well done application, you just file it. There's no money involved in turning the provisional into a regular filing. Oftentimes, with these one-page disclosures, there's a substantial amount of money involved in taking that from there to there. The problem is you cannot add subject matter to the patent application later on once it's filed.

Bernstein: Unless it's really the patent application, correct?

Boehm: No, the subject matter has to be supported—has to be described—

Simon Bernstein: In the provisional.

Boehm: Uhhuh To that text, or you lose your filing date.

Wheeler: But the zooming element, then, is not in addition.

Boehm: Is not in addition? You mean...

E. Bernstein: It's not even in there.

Wheeler: You can't add subject matter. So if he did describe zooming, then it's not in addition.

Bernstein: Did he, ?

Wheeler: I am asking you whether he did or not?

Boehm: I'm not clear on what you mean. You can't add additional subject matter after the filing date of an application or you'll lose the right to that filing date.

Wheeler: The provisional? You can't add subject matter to the provisional?

Boehm: To any application...any patent.

Wheeler: But if he did describe the zooming, then the zooming element is not an addition in the formal.

Boehm: Right. It's supported. If he described it in the original, you can base claims on it later.

Wheeler: And have we said that the zooming is in the provisional?

Bernstein: Nowhere that I can see.

Simon Bernstein: Wait. You're the lawyer reading another lawyer's work. Is it in there?

Boehm: Do you have a copy of it?

Bernstein: Yeah, right here. It isn't in there if it bites you.

E. Bernstein: It's not in the filing either.

Simon Bernstein: It's obviously not in the filing if it's not in the provisional.

Bernstein: No.

Simon Bernstein: Can you make reference to something...let's say he uses the word "zoom".

Boehm: Exactly. I'm pretty sure the word "zoom" is in there, isn't it Eliot?

Bernstein: But what Doug's saying is that had you written the patent, you would have described the invention as the ability to do this cool zoom that we all...and just said this is the cool part of what we're doing. What Ray's missing in the outline is the ability for you to put a picture on a Web page.

Wheeler: He did know that an important element was the fact that when we went in and made it bigger, we didn't pixelate.

Bernstein: It didn't pixelate. Not in here at all.

E. Bernstein: Not even mention to that concept.

Bernstein: Complete failure. It's not.

Wheeler: But if said it doesn't distort when we zoom...

Bernstein: Nope. Nothing like that.

Wheeler: That's the same thing, isn't it?

Bernstein: Yeah, but he hasn't said anything...he doesn't even tell you ...

Wheeler: What about the panning element, or is that element not patentable?

Bernstein: No, that's part of the whole process is to be able to zoom while panning.

Wheeler: Here it is. "The above process can be utilized in order to create higher zoom capabilities with each new depth layer of an image..."

Bernstein: No, but that's a new depth layer which is bringing in another hotspot image, so it's really a completely different subject.

Boehm: Oh. Okay.

Boehm: Okay. Where is that?

E. Bernstein: I read it to, he's very crafty you know.

Boehm: "Where the zoom capacity of up to 1700 times or greater may be easily obtained with the [present conventions.]" Are they talking about the hotspot now?

Bernstein: No.

Boehm: No, it's the general zooming capability.

Wheeler: So it's not in addition.

Bernstein: Well, explain to him where it's missing.

Wheeler: You guys didn't put it in the formal...I don't mean you...he didn't put it in the formal one in the depth in that what we want to do it but he could have without it being construed as an addition.

Boehm: Yes.

Boehm: Well play lawyer on you now<Laughs; cannot understand his comment.>

Wheeler: Right - sorry

Boehm: Whether or not it's supported is a question that's going to be determined either between you and the examiner...probably not, it's between you and another

lawyer someday when the case is litigated. The question is And again, the test is: Can the average person skilled in the art—the average designer of this type of software—can he read this document and make and use of your invention without inventing it? That's the test. Now, whether he uses the word "zoom" in here and "magnification" later, that doesn't mater as long as he would have gotten it. If it is so simple to build by reading this, you don't need any subject matter. If you're combining three elements A, B, and C, and A, B, and C are standard in the art, and you tell them these are standard in the art, go combine A, B, and C, that could be a one-page application. The average person will pick it up and he could. It's a patent test. Are you with me? The more complex it is, the more you want it supported in this text.

Simon Bernstein: What if it is basically simple, and he just wrote it as basically simple, does that support our position anyway though?

Boehm: Does that support our...Sure...

Simon Bernstein: I mean, if we were to litigate against another person that infringes on our...

Boehm: An infringer.

Simon Bernstein: Supportable for the sake of argument?

Boehm: Right. Yes. That is a fair argument

Simon Bernstein: OK so then I don't know that, at least from first blush

Bernstein: That's the provisional you're reading though, right?

Boehm: Aren't they the same? I think they're identical, aren't they?

Boehm: You can check in his notebook.

Boehm: Are there differences?

Bernstein: Where did you find that piece that you just read?

Wheeler: Is the reason...now continue answering my question...is the reason we came to the formal in March of this year, which I didn't realize that Joao. I thought that we had agreements for doing everything, but apparently Joao filed...

Boehm: For that one, yes.

Wheeler: But he didn't bother telling anybody.

Boehm: That's the one that we didn't find out until way late.

Wheeler: Okay, perhaps the reason that he did that was that was the easiest way to do it and the course of least resistance, and he thought he could go back...is there an amendment procedure?

Boehm: Yeah, there's an amendment procedure.

Wheeler: That he could do it a few months later or something like that?

Utley: We had a conversation before the formal filing, and, in fact, I have my notes here from that conversation.

Wheeler: Okay.

Bernstein: And you mentioned that there was no zoom.

Utley: Yeah, I said...

Bernstein: Claim one.

Utley: Yeah, Here are my notes. This is my original copy. Claims do not reference stitching. The patent app does not cover providing enhanced digital image with zoom and pan controls. It covers for creating enhanced images to show zoom and pan functionality without distortion." Those are my notes.

Bernstein: And you told him that.

Simon Bernstein: Here's a man that was cognizant of what was necessary to be in there. How did a guy to file a patent without any of us—obviously, not me, but Eliot, Brian.?

Boehm: Jim wasn't around yet.

Simon Bernstein: Okay, but Chris was and so on and so forth—how did they get through the crack that he did this?

Wheeler: It didn't get through the crack. Brian addressed it with him.

Bernstein: And everything is shredded now, too. Everything else is shredded.

Utley: Kind of what he was going to do—his time factor—he was going to...he didn't think he would get this in. He would submit it and then would turn right around and amend it.

Boehm: Did he really say that?

Bernstein: Yeah.

Utley: I wouldn't say amended, it was because of the stuff that was coming...

Bernstein: It was supposed to be in there.

Utley: ...he was going to smash that all together and file it.

Simon Bernstein: Was that the same time, Brian, that he was leaving the firm?

Bernstein: Yeah.

Simon Bernstein: So would you say that probably...

Utley: he knew at the time that he probably would be leaving?

Utley: Right.

Simon: But he wanted to get all of this in place so he could do the billing and get that part of it in...

Utley: I don't know that.

Boehm: Just speculating.

Eliot Bernstein: What day did you give him those notes?

Simon Bernstein: I don't ever have to speculate on billing

Utley: I don't have my address book with me...I didn't write the date down, but it was the date that he was here. He came.

Wheeler: He wanted to get it done to take care of you, make sure it was filed for you.

Simon Bernstein: That could be too. One other reason is...

Wheeler: We're just speculating.

Wheeler: And I'm not trying to... <Everyone talking at once.> I thought he was trying to work on our best behalf, but one time or two times that I met him, it seems like he was earnestly trying to help. Who knows? Maybe he was incompetent. I mean we're only suggesting that it would have been incompetence

Bernstein: Well, the fact that it's not in your patents, right up front, this is the invention, is a gross neglect. And the fact that it doesn't say, "this is what the invention is trying to do. This is the feature..."

Simon Bernstein: The point is not whether it's gross neglect or not, it's what the damage is if there is...if, one, gross neglect is of any import; and two, what is the damage? it has caused iviewit. That's what I think we need to ascertain here, and if we can ascertain it.

Utley: How do we fix it?

Simon Bernstein: Of course lets try to fix it, if we can't fix it then we'll worry about...

Eliot Bernstein: Well 1st lets fix it

<Everyone talking at once.>

Boehm: Let me go over the procedures so everybody's clear. Again, on one end of the spectrum you file a very sparse, like a one-page provisional application, and it's cheap, and the purpose of the provisional is to get you in line...it is to protect your date. What you're trying to do is get the benefit of your priority date. When you invented it. When you're in line in terms of whose the next guy that invented it. Whose the first inventor?

Simon Bernstein: Someone comes after you the second day after...

Boehm: Who's the first inventor, that's what you're after.

Simon: I understand. I really understand...you don't physically stand...

Boehm: Not physically in line in the patent office is right, not or even in physically in line in order as well. Okay. One-year letter, the provisional expires and you have to file a non-provisional patent application, okay? Many times it's identical. If you do a good job up front, you just file that, but you need to put claims on at this time. When I do a provisional, I try, if there is money and time up front, to do it once up front. I even write the claims. As a matter of fact, I don't even like to file provisionals because there's not much of an advantage. If you've got the time and the money up front to do a good job, well then, just file it as a regular application.

Simon: Understand that at the beginning, the time and the money...I mean, the time was certainly available, but the money was a short substance. So it was obvious that Ray would be working in a most expeditious way.

Boehm: Well, that's why the..

Simon: Which might have short-circuited us because of all of the lack of funds.

Wheeler: Well, that's true because the filing date is 3/24/99 to endorse that...that was very early in the game.

Simon: We did it in your office Chris in your library...in your conference room. The only meeting I had with him was while we were going to file the patent and that was in your office.

Boehm: Okay, 3/24/99 is the provisional application.

Bernstein: That's what I'm saying. Well, Chris,

Boehm: So even at a year, he filed the second one with claims.

Buchsbaum: Yeah two things happened during the year. One, the Company was doing other things, even though they knew that was coming up, and two, I guess there wasn't a whole lot of money to allocate towards doing that much.

Simon: Here's what we did. We hired Ray Joao on the monies that were raised by the investors; and then when Huizenga was coming in with their money, and when that money came in, we made a company decision that the first and foremost thing was to get the patent filed properly. So the fact that we were going to spend more money and get them completed at that point had already been made.

Simon: Okay, but prior to that, we were working on short forms. Then after that, we started to raise capital, and we always knew that the priority was intellectual property, so were going to make sure that those got done right. Brian's been working on it ever since, and I felt comfortable...I never did feel comfortable with Ray Joao...just an observation.

Boehm: Hmmm...is it all patent attorneys? <Laughter>

Simon: No, no, there's nothing wrong. He came in, he's a nice guy, he tried hard, you know, all the nice things, but his work always appeared sloppy, okay? And that's the only thing I can say. You're a patent attorney, you see what he did. If I'm wrong, then let me know; but to me, it looked like it was a little slipshod. And then he made some statements that really bothered me, too, that I don't think he should have made to a client, and that is that he was filing his own patent. <Chuckling.> I mean, horseshit personally, I haven't heard of a patent attorney in my life telling me that he's an inventor filing his own patent. It really did bother me.

<Everyone talking at once.>

Bernstein: Transmitting video files on a communication network for airlines and...

Simon: It probably meant nothing because I don't think the guy was of the nature to be stealing from us, but I don't know! But I'll tell you this, it did ring a bell. From a pure novice, it made me a little nervous. I asked Eliot why he was dealing with somebody, but we were assured that this was a good firm...

Boehm: Let me look back in my own spiel...here with the provisional. You file a provisional, then within one year, you file a regular application with the claims. You can add claims to it; but if you add subject matter to it—in other words, if the zoom and pan concept wasn't well described, you have lost the benefit of that first phase. Right. Now

why is that going to hurt you? Two main reasons. One is if you put it on sale—offered it for sale— or you publicly disclosed it, there are certain regulations that say you've got to get something on file, so if you had publicly disclosed it, that would protect...getting the application on file will protect you from losing your date because of public disclosure and offer for sale. I think that's what he was trying to get the earlier dates for.

Simon: Sure.

Boehm: I spoke with Ray when I was trying to get all of these files, and his comments to me were...when we were on the phone—you remember, we were asking him where was this stuff, and he said, well, he kept building on and he learned more it got in there. After I reviewed these applications, I agree that you're learning more as you go along. I'm doing the same thing. So it's kind of a learning curve.

Bernstein: If they ever find a zoom description that adequately makes...especially in the claims...I mean, if you're reading the claims...

Boehm: But Eliot, he's going to say that the claims are of no import right now. All you have to do...

Bernstein: In the filings?

Boehm: In the filings. I can go amend those right now. We can sit down today and re-write them.

Simon: If it can be amended amend it. There's no problems.

Boehm: There's no problems.

Simon Bernstein: There's always maybe a little money that's been duplicated and that's it.

Boehm: Here's the problem, and that's what I want to get across about that. If he's trying to claim zoom and pan and I rewrite the claims to claim zoom and pan, and the examiner says, that's great, but it's new matter

Bernstein: But it's in the provisional that you can zoom up to 1700 times.

Boehm: If my claim is supported by the spec on that date, then you're fine.

Bernstein: Isn't it?

Boehm: I can't answer that without going into the...

Bernstein: But when we read the provisional and we see that, it says...

Simon Bernstein: Before this meeting took place, before we called this meeting, aren't you privy to everything that's been done?

Boehm: Oh, sure. I have everything.

Simon Bernstein: So when Eliot asked you that question, why can't you answer it?

Boehm: Because there's no...in my opinion, there's no clear-cut answer, yes or no, on the quality of the work product. It's a judgment call.

Bernstein: So that's an exposure, and what if the judgment is against us?

Wheeler: It's [an examiner] judgment call is what we're saying.

Boehm: The damage?

Wheeler: No, the examiner. <Everyone talking at once.>

Wheeler: Whether the subject matter is new or not.

Boehm: The examiner would...hold on...it's...

Wheeler: whose judgment call is it?

Boehm: It could be the examiner's, if he catches it. If it's not caught, and you get it to patent and you litigate the patent, ... at court. Or if the examiner catches it and I want to appeal it to the board of appeals in the patent office, it's their judgment call

Wheeler: Okay, so we go to court and we're fighting over the patent, we would argue that it's supported by the zoom 1700 in our language, and the other side would, say that's baloney that's too broad you didn't describe it enough

Boehm: You didn't have your invention...

Bernstein: Then you lose.

Boehm: We would lose only if you had a bar date come in there if somebody else invented before you, or if you put something on sale...or if we offered something up for sale.

Bernstein: Which we did.

Boehm: But the offer-for-sale date from our first meeting is not until September.

Bernstein: Right.

Boehm: So the offers for sale won't normally kick off a foreign...

Simon Bernstein: Could you explain to me what offer for sale means?

Boehm: Sure. As soon as you...you can't get a patent on a product after you've been using it for more than a year. As soon as you publicly disclose your invention, you've got one year in the United States to get a patent on file, okay? Even if you don't publicly disclose it...let's say I've got a method of making [] in my factory, but it never gets outside. I'm starting to commercialize it, I'm making money off my invention...the commercialization date a year later is you can't patent it in the U.S. So that's that one-year grace period.

Simon Bernstein: Aren't we within that period?

Boehm: Yes. As far as we know, yeah. As far as we know.

Utley: Yes-yes we are within that grace period

Simon: Okay, somebody explain to me, what am I doing here? Why am I sitting here? Are we saying that Ray Joao, other than being sloppy, but there's not much damage that could have been done or can be done because we can fix it, which really would make me the happiest to hear that.

[not in transcript: PSL look at change above although minor it indicates perhaps the change in text to match new text]

Utley: Can I jump in? Let's just say there are two steps. We're going to make a filing this week; and to the best of our knowledge, we have swept up all this in this filing, and that will be within the commercialization period. The second thing that we're going to do is we're going to look at filing an addendum to the original formal filing to strengthen the claims - broaden the claims ... to the maximum extent that we can.

Boehm: if we need it...if we need it.

Boehm: It'll be a lot of this was swept up into the application.

Utley: What we're trying to do is protect the date day of March 24

Boehm: The original...

Utley: The original date as March the 24th, but filing should remain an objective.

Simon Bernstein: Brian, if you broadened the language now, would that be a red flag to the commissioner that you should have done it earlier? Or should we just say that this has always been there?

Buchsbaum: You mean the examiner of the commission

Bernstein: We're not going to be able to say it was in the claim.

Simon Bernstein: What happens when you start those amendments or broaden them is you start to admit that you didn't do it.

Boehm: Um, yes and no. We...I do that all the time.

Simon Bernstein: It's common then?

Bernstein: If they do it all the time, then we have to do it.

Simon Bernstein: But not until I feel more comfortable with it.

Boehm: We normally have a search done. The patent examiner will do a patentability search, and he will come back and reject it. The problem is if the claims are too narrow to begin with, he will not come back and reject it, he'll allow it, and boom! Now I can't amend it he's in. [], we're done. But I can file an continuation on it. I can keep dragging this out and get broader claims as long as the subject matter is...

Wheeler: So that's why he stated it broadly versus narrowly?

Boehm: No.

<Somebody comes into the room to take food/and or drink orders.>

Boehm: No, but as far as, doing it broadly, if you're saying to claim it broadly it's our job to claim... as prior art which I doubt the claim is as broad as the [] allows...

Wheeler: Right. That's what I'm saying.

Boehm: And this is claimed broadly.

Wheeler: Right.

Boehm: And that's the normal tactic, to claim things broadly, and then wait for the examiner to come back and say, "Oh, you can't get it that broad," and then narrow down your claim.

Wheeler: Okay, so isn't that what he was in part trying to do? That's what he's been saying, yeah.

Boehm: Yeah.

Wheeler: Well, would that not be consistent with how patent attorneys try to do things?

Bernstein: Well, claim one, if you look at their claim one, Chris, that they've written, it identifies...

Wheeler: Who's they?

Bernstein: Foley & Lardner. It identifies what you're trying to do. [not in transcript: Stephen note how Dicks name is deleted and Foley's name is screwed up, may indicate who was changing this transcript]

Wheeler: Okay, so maybe it should have been written differently.

Boehm: You won't get two patent attorneys to write the same claims.

Bernstein: Well, no, but you try to write the claim, and that's the teaching you and Steve both represented us here, to describe in its broadest term...

Boehm: Right.

Bernstein: ...the invention.

Boehm: Well, I can't say that this isn't broad. This is very broad. This might be rejected for indefiniteness...I don't know what it is...but now he's got the opportunity to go back and...

Bernstein: And Brian, you know, there's print film image in here, it's all supposed to be out of here.

Wheeler: What you're telling me is that in your forum of law there's always going back and refining and refining and refining that was wrong.
<Everyone talking at once; two different conversations going on at once.>

Bernstein: This is like he just completely ignored what we said over a year. He didn't do a thing. Nothing. No comments, nothing.

Utley: Almost nothing between the provisional and the formal process.

Boehm: And some people intentionally file narrow just to get something on file. Then they can come back and repair it without damage to it.

Bernstein: But you don't know that because an examiner...

Simon Bernstein: You'll never know that until you have a litigation.

Bernstein: And then the question is what potential damage does that...

Simon: That damage potential and that remedy will be then taking place at that time, not now.

Boehm: That I agree with. Even if we decide something now, you won't know what the outcome is for five and a half months.

Simon Bernstein: ...wouldn't happen anyway. You wouldn't even know that.

Utley: Let me come back where I was. We are going to file on the 7th, Wednesday. As far as we know, that will cover every element of this invention that we have our arms around at this point in time.

Boehm: I believe so, yes.

Utley: And we should go back and address what amendments we can make to the claims in the filing of March this year and determine within the spec of the filing how broad those claims can be. I mean, that's going to be the test. Within the spec of that filing, how much leverage have we got to broaden those claims so that we do have a priority date which is back about a year ago last March.

Bernstein: So we want to insert everything going into this one into that one?

Utley: No, it'll be...

Utley: It'll be based upon the preamble, if you will, of what's in here.

Boehm: We do reference it. As a matter of fact, this is the cover page, Brian, of the application we're going to file.

Utley: Yeah, you reference it right there.

Bernstein: But you can add claims to that one that you're referencing that would encompass what we have in today's filing, which is really...we do want it in there.

Boehm: Yes, I can claims to the zoom and pan to get you back to the original date in this one since I claim to this onto his.

Bernstein: Well, we should do both.

Boehm: Well, you can't get two patents on the same invention, so it depends on where we want to go.

Bernstein: Well, we want to definitely get it in on his because it gets us an earlier date. Correct?

Boehm: No. It's a mess with these dates. What will happen is...nobody will worry about the date unless there's an occurrence, and that occurrence might... it's a major problem. You won't find out about that occurrence until you sue somebody, and then they go search in Australia, and they find a reference that somebody's done this before in the library, and then you worry about the date. Were you before him?

Bernstein: Well, that's what I'm worried about. I'd like to go back to our earliest date.

Wheeler: Can I point out one other thing? I know we look for the word...Eliot looks for the word...I know we look for the word "zoom," but there's also other language in here too. Sometimes we get caught up in a word "zoom," when what is zooming other than enlarging or reducing? And he does have language in here, "when enlarged or reduced, these pixels of the digital image becoming distorted a feature which

typically results in the digital image being fixed to an original size or being available at low magnification, such as, for example, magnification from 200 to 300 times. These digital images are also difficult to enlarge to a full screen without a tremendous amount of distortion present in the end product."

Wheeler: I mean, he's describing I mean that's zooming. Reducing and enlarging is zooming.

Bernstein: But he's not putting it in your claims, that's what he's saying. You see, this is different.

Boehm: But it doesn't matter right now

Wheeler: But it doesn't have to be if you've made mention. The opinion is that it doesn't have to be as long as he's ...if you made mention...if you've gone on record of having described this

Boehm: This is the background that's...problem. He's got...

Boehm: That kind of invention, right, it's got to state...

Wheeler: Well, I didn't get to that either.

Bernstein: Right. And that's where it's not.

Boehm: I pointed out a couple of things. It's not as...

Bernstein: Within the claims, the claims I'm reading, you could not...

Boehm: The claims really don't matter.

Bernstein: In the patent?

Boehm: The patent claims on a pending application basically don't matter.

Bernstein: No, the ones he filed.

Boehm: Yeah, they basically don't matter. I can go back and change them.

Bernstein: Okay. Why? So we want to change back to the original one he's filed, put as much language as we can that we have today...oh, it's all supported. Everything you wrote in that new one is supported in this one because it's the same process.

Boehm: That's the ultimate problem that Steve and I—Steve is Becker, the other patent attorney that actually wrote these patents <in audible>—but that's the ultimate problem that we're worried about, and that's the problem that you always worry about unless you first of all have a handle on the invention, inside and outside, and second of all, unless you really have a handle on Prior Art so you know where you

want to go with this. Then you spend the time and the money to do a good original provisional filing. You've got a pretty good shot that it's supported then. But when you file as, oh, I've got to try and cover this base, and when you do this kind of stuff, there's always going to be a question of what was supported when.

Bernstein: But that's fine. It is supported.

Simon Bernstein: We're off the subject matter.

Bernstein: So we should definitely claim back to the earlier date?

Boehm: We may get a rejection, or you may find out in litigation five years from now, that none of this was supported. Some court may say that you never talked how to do this because your software wasn't in the patent application.

Bernstein: It is, though.

Boehm: Well, the code isn't. They might say that these broad diagrams and these flowcharts aren't good enough. There's always that risk.

Bernstein: But we're trying to say that if they accept it, we want it to be to the furthest filing date that we can, which is March 3, 2000, and that's where it should lie; and if it's going to get argued let it live or die at that date.

Boehm: That's what we're trying to do right now.

Bernstein: Okay, good. So I'm under the impression from this point that we're going to encompass what we've learned what we're filing even in this other one even into the original one so we can claim back to a March 3 filing date that claims back to our original March patent...

Boehm: March 24th, yeah, all of that will go back toward what is supported in here, in the original. Not supported in ours.

Bernstein: Okay. And it's all going to be supportable because you're going to be able to pull up an image of the nature that we are discussing, and anybody with an eye can see that you've now done this.

Boehm: <Inaudible comment.>

Bernstein: Well, you're going to be able to show your invention, aren't you?

Boehm: No, no.

Bernstein: You can't?

Boehm: You live or die on what's in the specs. That's why...

Bernstein: Then get it in there.

Boehm: Yeah.

Bernstein: You can't bring it in as evidence what the invention is?

Boehm: Only outside evidence of what the average level of skill in the art is, okay? If somebody says that the flowchart isn't detailed enough, I'm going to go, "Oh, yes it is. Here's 29 programmers who are going to testify and say yeah, I can do that in my sleep with this document." So, there's always going to be a battle about the level of support.

Simon: Maurice and I—that's why I asked him to come in—Maurice and I were talking because neither one of us understands patents or how you file them or invention actually. What we do understand a little bit about is the theory in business; and now that we know that Ray Joao was somewhat sloppy—I'm not suggesting that he's not a fine attorney or anything else—you have been...you have reviewed all these patents that we have, whether there are eight or ten of them...

Boehm: There were eight original filings, and then...eight original filings.

Utley: Okay. And then how many do we have now?

Boehm: Let's look at the chart right now, but it's basically. We've got 17 applications that have been filed. These old ones are dead now because they were provisionals, and we've basically covered all...we pointed out basically covering two, maybe three inventions, so there's not...I mean, if we were to start over, maybe you'd do this with two patents, maybe one patent. So.

Simon Bernstein: Who owns them?

Boehm: Who owns it? iviewit Holdings, Inc.

Utley: Owns all of them?

Boehm: Except for...<Pause, and then text comes in that doesn't seem to be answering this open question.>

? Video playback over a network

Wheeler: How did he get in? [not in transcript but this refers to Jeff Friedstein on an invention]

Bernstein: He's part of the invention.

Boehm: An inventor - inventorship.

Boehm: So I've so I've got a document right here for him to sign. If he signs, then I do a couple of things.

Bernstein: He signed that when you faxed it to him originally.

Wheeler: I have copies of each one of these. Can I get a copy of your []?

Boehm: of this? Sure.

Wheeler: I have a copy of each one of these, I believe, or most of them...

Buchsbaum: Can I ask you a question? Your saying everybody that has an obligation to sign is on the list of names in these patents?

Boehm: You preferably don't...well, unless you have the new ones...

Wheeler: I don't have the new ones, but...

Bernstein: That's an old one. That's old.

Buchsbaum: You're saying everybody that has an obligation to sign is on the list of names in these patents right, because the company was part because the Company was doing, is that what you're saying? Because I don't even know if everybody has signed because you may due corporate due diligence for financial reasons or if...and they will say has everybody signed off on these patents, and if three people don't...if one person hasn't, he has an obligation to sign?

Boehm: Brian, have you signed?

Buchsbaum: Has everybody signed off on these? Brian?

Boehm: See these tabs [refers to tabs for inventors Bernstein, Shirajee, Friedstein and Rosario to sign] right here? That's what I'm trying to do today. As soon as...I'm going to have people sign, me sign...all the inventors sign. I've got to get a hold of Jeff

Bernstein: I thought we did that when we filed.

Boehm: You only signed one real document, didn't you? Did you actually a declaration? I know you didn't sign an assignment over but you're real clean on it because these are all based on the original filing , which is assigned to iviewit holding already

Bernstein: What's that mean?

Boehm: So all of the other inventors would have a helluva problem trying to say they owned anything.

Simon: Again, this is a little off the subject matter, but I have asked Chris about it before. If something were to happen to iviewit, and it were it went into bankruptcy, what would happen to those patents? How would those patents []?

Wheeler: It depends on which at iviewit you're talking about.

Simon Bernstein: The one that they are held in.

Wheeler: Well, first of all, holdings is held separately versus...we're operating the company out of a separate entity, correct? iviewit.com. So, let me think there...

Buchsbaum: The operating company is iviewit.com.

Simon Bernstein: All I'm concerned about is, for example, that the largest creditor...it wouldn't be a creditor, it would actually be an investor...would then...

Bernstein: They're not a creditor.

Buchsbaum: Okay, then the largest creditor could come in and pierce the corporate veil of iviewit.com and say that this is just a way of protecting the only valuable asset of the company away from creditors. Is there a possibility of that?

Boehm: Obviously there is.

Wheeler: There is a possibility, but that's one of the main reasons... But the loan, they made the company who wrote the patent, join in as a guarantor anyway on it.

Bernstein: Well, that would be all of us. All of those would be all of the investors getting a piece back?

Wheeler: No, no, no. On the \$800,000 loan, those people, it's secured by the patent.

Simon Bernstein: What about the \$600,000...or the other \$800,000 loan?

Wheeler: The others weren't loans. The others were equity, as I recall.

Simon Bernstein: No, no, they have claims.

Bernstein: Well, they're supposed to be converted to equity, which is another issue.

Utley: But there where note holders

Wheeler: No, because there was no quid pro quo at that time. The note holders I mean you can't go back and do it, we had that talk Si

Wheeler: I mean, you can't go back...

Bernstein: The note? I believe they're not final, even though we told people they would be by this time.

Wheeler: The note holders took their money in without taking security. Now you...<Indecipherable. Everyone talking at once.> ...new considerations...I said now you can't ... back to a failure to the corporation

Simon Bernstein: ...Board if everybody that was a creditor found, everybody that was a note holder at that point there was no what would you call it - problem

Buchsbaum: and that would be protected by the courts anyway usually. The court would see this probably as a you know a fraud

Wheeler: You could have two frauds: fraud of creditors and fraud of shareholders.

Simon: No, Chris I'm not worried about fraud. I'm really concerned with the fact that what we did here, the last loan that we took in, from...

Bernstein: Crossbow.

Simon: No, not from Crossbar...

Bernstein: Crossbow.

Wheeler: Crossbow

Simon: ...is secured by the...

Wheeler: ...the term of the deal, right.

Simon: And that's perfectly acceptable to me except that everybody else that had loans prior to that at that time should have been considered with the same equity because ...posses able and Chris told me that that was the perfect time to get it done

Bernstein: Yeah, but would Huizenga lose his?

Bernstein: Would Huizenga lose his stake in it to Crossbow?

Wheeler: No, no, no, it wasn't...I said that if there was going to be new considerations from those people, we all could of...??

Simon: We all could have put in another \$10. I mean, at the time we did it with Crossbow, we should have made sure that our other people...

Bernstein: Are protected.

Utley: No, no, no. We would have had to issue new contracts out for everyone.

Wheeler: There would have had to have been some material consideration, not just \$10. It would have been...

Simon: So it would have been \$10,000...

Wheeler: Well, then, you could have...Crossbow, we didn't even talk about Crossbow at that moment, and I said you couldn't go back and just collateralize. You couldn't go back for money that you already put in. But if you put in new

considerations that you could demand as a condition to be collateral.

Simon: What we should have done, or what we maybe we still should do to protect our original group of investors, is to have them pony up a few more thousand or whatever you think is legitimate, and amend the contracts to protect them as well.

Utley: That's new subject matter.

Simon: Well, I only brought it up because it had to do with the patents.

Utley: I know but can we finish the patent discussions before we bring up new subject matter.

Simon: You can, but I want to make sure that we do finish.

Utley: No, I agree with you Si.

Si: The problem is that I made claims to certain people like Don Kane, who put up \$100,000, who thinks...

Bernstein: Let's get back to that. No, let's get back to it. It's a definite point. There are people.

Buchsbaum: This is a business issue for later.

Bernstein: No, we're asked by these very people these questions.

Boehm: Did you get your question answered on the...

Buchsbaum: Yeah, I just wanted to understand...you know, I got an answer. It had to do with the obligations Si I was trying to understand if somebody does due diligence now with regards to understanding what is there and what has to be done, like those yellow tabs. [Yellow tabs indicate signatures of missing inventors]

Boehm: Yeah, but after...I find everybody, we can get guys to sign.

Buchsbaum: We aren't that many. I don't know on that sheet what you have, but I don't think there are that many names. There's what about five names?

Buchsbaum: There aren't that many...you don't have that many. I don't know on that sheet you have, I don't think there's that many names.

Boehm: No, there's not.

Boehm: So we have everybody but Jeff, if we can get Jude and Zak.

Buchsbaum: You just have to get people around and sign.

Boehm: No, that should not be and issue.

Buchsbaum: That might be questions brought up when people do do due diligence. Is everybody else on these?

Bernstein: That's why we're closing it. Right?

Boehm: We'll record what was in the patent office(...???) can do.

Utley: The other piece that's not in any part of the original filings, which is the reduction of the technology to a disciplined process—the mathematical representations of what's in and how it works and stuff like that.

Wheeler: (...???)

Buchsbaum: That will also be included in there, right?

Utley: We'll put it in the new filing...one of the new filings.

Wheeler: I form my opinion of everything, and we can talk about post solutions but I think Brian wants to get this back on track, but to me there's bad news and there's good news in this. The bad news is, just like anything in life, perhaps we would have liked to have tidied up some things better, like to have had Mr. Joao tidy them up. The good news is considering the state that the corporation was in in the early stages and the variable limited resources that it had, I'm glad that we have an awful lot on record that we do have on record, to be honest with you.

Simon: As long as it's not to the detriment of what we thought we were filing, I have no...I couldn't agree with you more.

Wheeler: But I think I like your approach, and I assume it's your approach, too, in that I assume that you're doing a fairly comprehensive new one, but then you're going to probably...

Utley: Claim priority back to the old one.

Wheeler: Right, but you're also going to do your amendment because now we're finding out that it's not an uncommon procedure and it's not a red flag.

Utley: Two things: the new filing on Wednesday will claim priority all the way back for as much as possible back to March 24th last year. Second, we will look at the March 24th year 2000 filing and determine how we should amend that to include additional claims and broaden that filing so that it more fully represents the knowledge of the invention as of that time.

Bernstein: Does it claim all the way back?

Wheeler: It'll go all the way back...

Boehm: as long as you don't go outside what was described.

Bernstein: No, the math is just describing the original invention.

Boehm: We'll, I'll never know the answer to that until it's litigated.

Utley: Due diligence.

Bernstein: Right, but from your perspective here, that's what we're setting up. Correct?

Boehm: We're going to try.

Bernstein: Okay.

Boehm: The question never even gets answered half the time in the real world. I will claim priority back on the document, and then if the examiner doesn't care, nobody cares

Bernstein: It gets through.

Boehm: It gets through.

Wheeler: Would it be a fair assessment—I'm posing this more as a novice, not as an attorney here—since we're not at IBM and we don't sit down at the very beginning and work out all these equations and all that, that in an invention such as this by a Ma-and-Pa type of inventor, and now since we're getting into the nuts and bolts and really uncovering, in essence, what's behind it, as Brian dissected it as we moved along, but that's all we're doing? I mean, that Ma-and-Pa inventors do that as they go along? They add the flesh to the bones as they go along?

Boehm: Boy, that happens, and we try not...we try to minimize the amount because if the flesh that you have to add is new subject matter and you've already sold your invention a year ago, you're dead.

Wheeler: Well no, Let me at it a different way. It does this, but I can't describe how it does this. But now we find out...we tell you what it does, now we're telling you in detail how it does it.

Boehm: Yeah, in terms of we claimed it properly.

Wheeler: So I'm not adding flesh in defense...

Simon: New flesh.

Wheeler: ...new flesh. I've got the box, now I'm disclosing what's in the box including the gears and how it works.

Bernstein: No.

Utley: No. Here's what the big difference is. The original filing claims a process for print film imaging.

Bernstein: Well, that was all stricken, by the way. That's why I'm having a big problem. I was going to get to that next, Brian.

Utley: Okay, good.

Bernstein: But we have discussed with Ray Joao numerous times to take out the references to print images out of this right here. Over the course of the year in the 59,000 modifications back and forth, we continuously pushed him away from the words that I see in this filing, and that's what's so disturbing to me because we sat here when...

<End Side 1; begin Side 2>

Buchsbaum: That would be conditional, probably.

Simon: Right, they probably will.

Wheeler: Their not going to want in fact their going to say take it off aren't they

Utley: No Crossbow notes would be converted to equity when someone else comes in.

Si? Of course, and that's gone. And those issues are gone.

Wheeler: Well, Yeah, so that it was the ...it was intelligent way to do it...and I'm not...

Buchsbaum: Crossbow would probably manage the million dollars anyway

Wheeler: By the way, if we did do a deal by which we tried to collateralize it even further, then we'd have to have some sort of provisions as well to get rid of your collateral.

Simon: Yes, of course. As soon as it converts to equity, it's gone.

Wheeler: But I mean, what if you didn't convert yours to equity[]?

Simon: Then you'd have to lose it anyway.

Wheeler: But at a point.

Utley: It just becomes a normal stockholder...

Simon: Right.

Wheeler: It would have to drop away or something. For instance, it would drop away when theirs drops away.

Utley: The stockholders, in the event of a default, the stockholders, the distribution that takes place, includes all the stockholders according to the rank of the preference. So the preferred get first cut, and the common stockholders get the second cut, whatever is left for

distribution. But of that amount[] unless there's nothing to distribute.

Simon: Not if one of the preferred stockholders has a collateralized position and the others don't. If one of these preferred stockholders...

Utley: There's no stockholders that have a collateralized position.

Simon: That's true.

Buchsbaum: You're talking about the small amount of money, that have any value, it should be reasonable value, and those would be taken out anyway.

Simon: Except that we seem to feel that we have an obligation to those, to protect the other stockholders who...had all good...I think its prudent anybody to ask permission

Buchsbaum: A good way to do it is the way he said to do it, and that's to [?].

Utley: Will you look it up and see what it's going to take to do it?

Wheeler: I'll coordinate that

Utley: I'm not clear. What are we trying to do? Are we trying to provide for collateral for new money coming in, or are we trying to...? We're not trying to collateralize money which has already been...

Simon: I don't know. Can you handle the old money the same way? I don't think so.

Wheeler: We have to see. We might be able to consider it for the full amount in the view of the fact that if you had enough substantial new consideration, ...

Buchsbaum: The problem is that you may have to go back to Crossbow to do that, and you may be better off just to do it on subsequent money.

Simon: Well, but to ask Don Kane to put up \$10,000 when he's got \$160,000 in the...\$135,000 in the company, and then he only gets 10%...\$10,000 worth of consideration...I'd like to protect his whole \$165,000, which is what he has.

Buchsbaum: The answer is you go back and ...

Utley: I don't think you can do that because that's equity. It's in common stock.

Bernstein: It's not equity. It's a loan.

Bernstein: Don had the stock prior to his putting up the money. These are loans. There's \$400,000 that's on the books. Then there's another \$100,000 besides what he put in originally. Sal has a loan on the books of \$25,000. Your guy should have had a loan on the books for \$250,000.

Utley: No, that's equity. Okay.

Simon: At any rate, <tape cuts out[tape does not cut out on my tape]>...While I got Chris here I'm going to take advantage of his being here.

Simon: One of the issues we tried to do when we raised the last \$80,000 that came from Eliot's two friends Anderson and Mitch Welsch. []

Bernstein: Ken Anderson.

Simon: It was my knowledge, according to Jerry, that those monies were to go to Eliot, and then Eliot was theoretically to loan the money to the company so that Eliot would have a loan on the books and he would have sold his stock because Eliot has some personal needs that he needs to accomplish as soon as we get funded or we get some money in here. I'm under the understanding again. It could be way off.

Bernstein: How do we work that out, Brian? The 10? A loan?

Utley: Yeah, that's better because otherwise you will get taxed.

Bernstein: Will they loan me \$10,000 to pay the taxes?

Simon: Who loaned you?

Bernstein: The company just today?

Utley: So I took that as a loan?

Utley: Yes.

Bernstein: The money went to the company, which spent the money already—the stock money—from Ken and Mitch.

Simon: You haven't sold any of your stock?

Bernstein: No.

Simon: You just made an officer's loan.

Wheeler: Right.

Simon: Is that how you handle it?

Simon: You loan the loan back by some method at some point.

Bernstein: Right. Correct.

Buchsbaum: That's the way to do that?

Utley: Well, there's no tax impact...

Simon: but he would have had a [] gain.

Bernstein: Right. And there were other things at the time...right, things. At the time, the company needed the money and I didn't...not that I didn't

Simon: Sure, I just wanted to make sure that it was done. I didn't even know ...???that bank account

Bernstein: Not that I didn't.

Simon: Let's finish up.

Utley: Eliot, let me summarize. I want to make sure we have an agreement of this meeting. Let me interject two final two points that we kind of skimmed over. One is you said that we want to go ahead and change the claims to go all the way back on this US, but we have sort of got covered on the one we're filing? The one we're filing is a PCT. It won't pop to the US for 18 or 30 months. Or we could file another PCT and a US, then the claims would hit the US. In other words what I'm saying is it would matter if we do the claims here. We could either fix up the claims here or file a PCT and a parallel US if you want US patent protection sooner. The PCT will split out to US, but not until later. You can file a US anytime...

Simon: Let me ask you. You're not a lawyer, what do you recommend?

Boehm: Well, it's more money up front.

Simon: How much money? A great sum of money?

Boehm: No, it's another grand to file.

Simon: For what we've spent already, let's do it.

Bernstein: And that protects us better?

Boehm: Quicker. You'll get a quicker US patent. It'll get you in line quicker.

Utley: The other point that you're making because in this week's filing we are going to claim all the way back...

Boehm: We're going to claim all the way back but this is what is supported

Utley: Right. So if we claim all the way back to March of last year, do we need to touch the filing that's already in motion?

Boehm: The one that's out there?

Utley: Yes the PCT. Do we need to touch that?

Boehm: No, no. There's a PCT and a US.

Utley: Right.

Boehm: The PCT, we will get a search back. In fact, we should get it in a month or so, and then you'll decide what you want to do with that, what foreign country and possibly the US, but he files the same thing basically in the US, and now it's in line in the US.

Utley: Right, right. But what I'm saying is if the new filing that we make this week creates priority all the way back and embraces all of the teachings of the prior...

Boehm: Zoom and pan stuff.

Utley: Zoom and pan stuff, filings, do we need to go and modify and update and amend those earlier filings?

Boehm: Those other two.

Buchsbaum: That's a good question would there be new recommendation?

Boehm: It depends on two things. One is how quickly do you want to get the US for the new filing? This is a PCT that we're preparing right now. If we file the US right away with it, then it makes less difference.

Bernstein: Less?

Boehm: Less difference because he's in line sooner. That's all. It just depends on how soon you want to get your patent.

Bernstein: Well, we want to go for the sooner.

Utley: The sooner the better.

Boehm: The sooner the better then let me play with this

Bernstein: Right.

Boehm: Plus you're gonna get an office action back from the patent office on him...

Bernstein: On that.

Boehm: For free. There's nothing involved.

Bernstein: Right, but it doesn't claim anything.

Boehm: I don't know yet. It claims...he'll get this blasted. It will will be rejected.

Bernstein: Yeah.

Boehm: It will be rejected. The question is do we want to fix this, or where are we with the other things? So there's no decisions to be made now on this, it's just that do you want to file a US and a PCT?

Utley: The answers yes

Boehm Yes

Bernstein: And we do want to fix the original work?

Boehm: We can decide that later.

Bernstein: Well, why would we leave it unfixed?

Boehm: Because you can't get two patents on the same thing. So if we fix this, you're not going to get it over here.

Bernstein: But then we lose the date.

Buchsbaum: No we don't.

Simon: That's what he's saying.

Buchsbaum: You really don't lose the date.

Wheeler: So were not going to...???

Utley: Because he's claiming all the way back.

Boehm: We may not. It depends on...

Bernstein: May and less, these are words that scare me.

Boehm: You don't like that, do you?

Bernstein: No, I do not.

Boehm: But I don't think this is the right time to make that decision now.

Utley: What is the right time?

Boehm: When we get some office action back on this patent. And when we hear from the patent office, we'll sit down say do we want to fix this, or do we want to fix this, or have we uncovered some killer Prior Art that blows this whole thing out of the water? You don't want to spend money right now if you can avoid it.

Wheeler: We've never done a search, have we?

Boehm: We did a search...I've done a search on...<Everyone talking at once.> on a dozen patents that really weren't on point. We didn't find any close Prior Art; and all I can tell these...

Wheeler: This was on imaging and video?

Boehm: Yeah.

Wheeler: That's incredible.

Buchsbaum: Yeah, it was huge.

Bernstein: If it is found impossible to do these things, why would people be doing them?

Boehm: I want to make...the tape recorders off, right? <Recorder turned off>

Buchsbaum: What does PCT mean?

Boehm: Patent Cooperation Treaty. It's a formal filing process for filing foreign patents.

Buchsbaum: Oh, that's the thing with the different countries?

Boehm: Yeah. So we file one application that splits out later to different countries.

Buchsbaum: Two years?

Boehm: Yes, but we'll get indicators before that. Our search comes in nine months, which is three months from now for the first one. But, Brian, they're searching this claim; this claim is crap. You're not going to get a good search on it.

Buchsbaum: So what? In six months or nine months, we'll start hearing from them?

Boehm: Yeah.

Bernstein: Well then we should do an alternate search on what you have.

Boehm: It's a judgment call. I mean, you asked me this question a while ago, and you said what would it take to get me comfortable because I'm kind of a pessimist and I'm an engineer, so I have that background where I look at it that it's half empty. It would take more searching, and it would take more searching inside the technical articles. And it would take quite a bit of work. I mean, I guess \$5,000, I don't know. It depends on what happens. Then, again, that will only raise you to a different level of comfort, that's all.

Bernstein: And then they'll say the same thing, and for another five grand, well get Rays to another indiscriminate level of comfort.

Boehm: Exactly. But we don't have to do that because we will be getting an article...

Bernstein: Right, from the searches.

Boehm: And from your investors because if I was working for them...

Buchsbaum: Let me put it another way. If you have somebody that will take this company and auction off the technology, okay? As it is existing...as it is unfolding, okay? And as the licenses come along. It's strategy. Some of these people bid on that. What are they really bidding on? It's potentials, right? Basically?

Boehm: Well, no, there's a present value of the technology. If you...

Buchsbaum: Well, not if you don't have patents issued on it.

Boehm: Well, sure there is. Sure there is. If he can get a royalty based on 2% of their products—or whatever it is—per minute, whether or not it is patented, absolutely.

Buchsbaum: My question is at what point does it become...is the efficacy there significantly enough from the standpoint of others now that would be doing their own review. You know, like, say a firm that would do the option. They'd have their patent lawyers take a look at what you're doing to see if they think it has a real good value. At what point does that come along? Is it six or nine months from now, basically? Is that when that probably would start to unfold as far as having a real relevant potential value? I've been trying to get a general..

Boehm: I understand your question. I guess I would answer...

Buchsbaum: General idea.

Boehm: If your licensees are spending a lot of money...

Buchsbaum: On your technology.

Boehm: On your technology, they're going to have their patent attorneys right now, today, go do a search, and they will have a good indication. They may come up with Prior Art that blows you out of the water. They may find nothing. They may not search it. They may say, we don't care about patents; it's the technology.

Buchsbaum: Reality, though, this is not the...more likely six to nine months as some licenses start to unfold here and as things start to come back, and that's when this thing will start to have some relevance more than it does right now? From the standpoint of the...

Boehm: That the patent will have relevance?

Buchsbaum: No, no. The technology has a value that can be created in the marketplace and turned to bidding.

Wheeler: Well, you can look at the technology as almost value added to the company. I mean, the company has worth because of the process and what we can provide and we can build it up. But it'll even astronomical more worth assuming that we have...that it's totally proprietary to ourselves. Now some companies have great technology that's proprietary to themselves, and it doesn't earn them money. For instance, Wang Laboratories went down the tubes. They had the best word processing, and they had the best of everything else. And, of course, a lot of their technology is licensed out there, as I understand it, to VisionAire and to...they did the true ones, and...

Buchsbaum: It's was also to get to the possible strategy for the company's investors, okay?

Utley: Right.

Buchsbaum: Or it may be at some point a window of huge value placed on this technology where you may take advantage of it.

Wheeler: Well, and to our investors, we have said, and we can continue to say, we are attempting to create a pool of intellectual property and protect it.

Buchsbaum: Okay.

Wheeler: But there can be no assurances that this will withstand the test of time.

Boehm: That is exactly it. And you never want even when it issues. You will get a good comfort level when you have a US patent issued in your hands.

Bernstein: Why?

Boehm: Because you've had an examination.

Buchsbaum: Because you've got some review.

Boehm: Because you have a presumption of validity.

Bernstein: That's why I'd like to get that first one corrected because that's the first one that's going to be examined.

Boehm: No, we've got one...oh, yeah, it is. It's the US.

Bernstein: And therefore I want that to be approved. The investors are going to say...

Buchsbaum: The first one that we're going to be issued will be issued in May.

Bernstein: And the investors are going to say what happened to patent one.

Boehm: 3/10 of 2000 was when it was filed. Typically a year...they'll get around to it within a year. Maybe it'll issue in. 18 months to two years

Buchsbaum: From right now or from then?

Boehm: From 3/10.

Bernstein: What is the process speed up? If you can show...

Boehm: If you can show somebody's infringing, you can have an expedited examination; but that doesn't always buy you much time, and you really have to get into the patent office the first time, and I'm not sure we can do that.

Wheeler: Wouldn't a good example of one way be that Apple had really great patents, and Microsoft was still able to come in and duplicate it, even though everyone knows they violated the hell out of the patent of Apple.

Boehm: Um, hum.

Wheeler: So I mean you could have a good patent and it could still go down the tubes. But another one I'm thinking of that did stand up was Polaroid had patents and Kodak tried to come in and do everything to distinguish, and wasn't able to and got clobbered, right? And there's probably a lot of every variation in between.

Boehm: Yeah. Wheeler: [Not in transcript this is strange here]

Wheeler: Are those the two extremes?

Boehm: Yeah,

Wheeler: those would be the two extremes.

Utley: Especially when it comes to method patents and software patents.

Wheeler: Yeah, what was the first thing that Brian

Boehm: ...and the more patents you have, the less chances. It's like putting out mine fields...less chances people to get around you. But if the original concept is broad enough and claimed right, Yeah, we can be okay.

Boehm: But what, the test - I guess what you're asking for is when we have that first claim promised, probably within two years of when you filed, which is March 10, 2000, I would probably say

Utley Doug come back, close it out again.
<Inaudible comment.>

Boehm: There were two points. One was the PCT and I got that in correct.

Buchsbaum: Right.

Boehm: The second point was everybody was saying you don't destroy documents. Lawyers do destroy documents; and in the patent realm, it is common practice to get rid of all of our attorney notes, but it depends on what the practice is in your law firm and your corporation. Most patent attorneys who use this practice that I've seen, it happens after it issues. You never do it before. I don't even like to do it then. I like to do it after all the...

Bernstein: I don't even understand why you're destroying it. If you've got nothing to hide and everything's on the up-and-up.

Boehm: But throw in the concept that I'm leaving the law firm. Let's say I'm leaving the law firm, my notes, who's going to follow up and destroy my notes to benefit you, because I do want them six months from now. Maybe that's what he's doing.

Wheeler: Yeah, he could have done it to protect you. He didn't want them around in the other office.

Bernstein: I don't know. I don't know. I don't even know if he knew he was leaving then.

Boehm: Now it's intentional!

Utley: But I want to comeback were going to file PCT and US on the new one. We're going to wait for the old one to get kicked back; and when it gets kicked back by the examiners, we'll then determine how we want to amend it. Is that what you said?

Boehm: No, I want to say something on that again. I think if you want a patent to pop quickly—if that's the goal, which sounds like it's a good goal—then, no, I think we should amend the claims with a preliminary amendment before the examination.

Utley: A preliminary amendment?

Boehm: A preliminary amendment.

Bernstein: Encompassing everything we can throw in there?

Boehm: Yeah, whatever support there is. But a preliminary amendment on whatever it is on the...

Bernstein: So we're going back to the original

Boehm: So I'll fix the 119 case yeah

Bernstein: March 3, 2000, to encompass what we've embraced.

Utley: When will you be in a position to recommend what that amendment will look like?

Bernstein: It should look a lot like the one we just did.

Boehm: Yeah, that's...

Bernstein: That's my guess.

Utley: When will you be in a position to...

Boehm: I'd have to...a few days...

Utley: About a week or so?

Boehm: Oh, Yeah, within a week, sure.

Bernstein: Okay. That's good.

<End of meeting.>



EXHIBIT M



DEPOSITION OF MR. UTLEY

(16) Q. Was there ever a time when you were
(17) dissatisfied with Proskauer's representation?

(18) A. There were times when I observed
(19) that there appeared to be some duplicative effort
(20) within the organization.

(21) Q. Did you address that with Chris
(22) Wheeler?

(23) A. I mentioned it to Chris and Chris
(24) made some changes in assignment.



EXHIBIT N



1930 SW 8th Street
Boca Raton, FL 33486

Personal Resume

Professional History:

President, Diamond Turf Equipment, Inc. July, 1995 to July 1999.

In 1995 the company was engaged in refurbishing obsolete and run-out golf course maintenance equipment and had annual sales of \$250K. Since that time the company has been transformed into a manufacturer of new machines which compete favorably with the best of the market leaders and an expected revenue for 1999 of \$6M. The design of the machines was by Brian and was accomplished while putting together a manufacturing and marketing team capable of supporting the rapid growth of the company.

President, Premier Connections, Inc., November, 1991 to present.

Premier Connections provides consultation and support services in computer and related business management. Customers have included IBM and other small businesses.

IBM, October, 1955 to October, 1991.

Brian retired from IBM as Vice-President and General Manager, IBM Boca Raton.

Prior to his assignment in Boca Raton Brian spent 5 years in Europe as Group Director for PC's and small systems. This responsibility covered all aspects of product management for all European, Middle East and African countries.

In 1983 Brian was appointed General Manager, IBM Biomedical Systems and asked by the IBM President, John Opel, to evaluate develop the long range strategy for this business unit. Brian subsequently reported back to the President that the Business Unit, while quite viable, should be sold to a related business in the medical community. Having received approval to do so, he negotiated a profitable sale for IBM.

Between 1965 and 1983 Brian was the project and systems manager for many major IBM computer systems which earned IBM billions of dollars in revenue. The most notable of these was the S/38 and AS400, one of IBM's most technology aggressive development programs ever and still one off IBM's most popular systems.

Brian entered the IBM laboratories in 1959 and immediately became the most prominent engineer on his first project with many innovative designs. As a result of this he was assigned to the German IBM laboratories to train German engineers in computer technology. He has been awarded a number of patents the most recent of which was granted in 1998.

From his start in October 1955 to the time he entered the laboratories Brian was a customer engineer responsible for maintaining IBM equipment on customer premises. During this time he self taught computer technology and transistor theory and developed the first IBM field course in transistors. This is the accomplishment which led to his assignment in the laboratories.

Education:

Having been born in England, he attended Beverley Grammar School and graduated in 1948 at 16. In 1949 he emigrated to the United States and completed his senior year at Ogden High School, Ogden, Utah.

He attended college at Weber College, Ogden, Utah and San Francisco City College completing two years of study.

Hobbies:

Brian is a jogger and for 40 years has been an avid glider pilot with many competitive successes.



DEPOSITION OF RESPONDENT

7 Q. Are you aware of any claims by Diamond
8 Turf that Mr. Utley improperly received intellectual
9 properties or patented them that belonged to Diamond
10 Turf?

11 A. Aware that --

12 Q. Mr. Utley is alleged to have improperly
13 received or taken intellectual properties of Diamond
14 Turf.

15 A. By Diamond Turf? No.



DEPOSITION OF MR. UTLEY

Q. Now, when Chris Wheeler first introduced you to iViewit, was he aware of the situation at Diamond Turf and yourself and

Page 244

Mr. Niose Freedkin or what was Mr. Wheeler's view of your position at Diamond Turf, to the best of your knowledge?

MR. PRUSASKI: Objection to form.

MR. SELZ: Okay. I'll restate the question. I'm sorry. Getting a little tired.

MR. PRUSASKI: I'm just objecting to the extent that you're asking him what Chris Wheeler's personal knowledge was.

MR. SELZ: Okay.

By MR. SELZ:

Q. To the extent that you know, what was Chris Wheeler's personal knowledge of that situation?

MR. PRUSASKI: Objection to form.

THE WITNESS: I believe Chris, Mr. Wheeler was fully cognizant of my relationship to Diamond Turf Equipment and to Mr. Freedkin.

we're talking about them because you said billing statements, which could be something totally different, I don't know.

265

MR. SELZ: That's the attached exhibits to the Amended Complaint in this matter that we're referring to.

MR. PRUSASKI: Okay. Thanks.

By MR. SELZ:

Q. Now, you had referenced Mr. Dick doing some patent work for yourself; is that correct?

A. Yes.

Q. And was that any patents arising from your employment with Diamond Turf?

A. It was arising from the technology and engineering work that I did, yes.

Q. So the hydro-mechanical work that you had done at Diamond Turf?

A. Yes.

Q. And was there ever a dispute between yourself and the owner of Diamond Turf with regard to the patents involved for that hydro-mechanical work?

MR. PRUSASKI: Objection, relevance and to the form.

THE WITNESS: There was a

266

disagreement as to ownership of the intellectual property.

By MR. SELZ:

Q. There was a dispute?

A. Yes.

Q. Did you ever advise the owner of Diamond Turf that you were going to patent these intellectual properties under your own name?

A. I did.

Q. Did you do that prior to patenting those or after?

A. They were never, they were not patented.

Q. Okay. They were not patented. Was the application for patent made?

A. No.

Q. Since your employment with Iviewit.com or Iviewit, yeah, dotcom, LLC, what patents have you taken out in your name, sir?

A. I have not taken out any patents in my name, other than what has been appended to patents filed by Iviewit and assigned to Iviewit.

Q. Okay. So they're all patents held by Iviewit and you're named as a co-inventor; is



EXHIBIT O



LETTER OF MR. KANE

-----Original Message-----

From: Donald Kane [mailto:dg_kane@msn.com]
Sent: Sunday, March 18, 2001 6:39 AM
To: Eliot I. Bernstein
Subject: RE: Board meeting on the 3rd

Elliot,

I spoke to Hank yesterday and will do so again today. The company is in a difficult position and the common shareholders risk losing the company to the preferred investors. Here are my thoughts:

1. It sounds like the company is out of money next week.
2. The company has supposedly accepted money from a new investor group without proper documentation/approval on the terms and conditions with Hank or the board. You need to talk to Alan Epstein about this process. I am very uncomfortable with what I am hearing about management.



WARRANT No. _____

**WARRANT CERTIFICATE FOR PURCHASE OF
CLASS B NON-VOTING COMMON STOCK**

THIS WARRANT AND THE CLASS B NON-VOTING COMMON STOCK PURCHASABLE HEREUNDER HAVE NOT BEEN REGISTERED UNDER THE SECURITIES ACT OF 1933, AS AMENDED OR ANY STATE SECURITIES LAW. NEITHER THIS WARRANT NOR THE CLASS B NON-VOTING COMMON STOCK PURCHASABLE HEREUNDER MAY BE SOLD, OFFERED FOR SALE, PLEDGED OR HYPOTHECATED IN THE ABSENCE OF A REGISTRATION STATEMENT IN EFFECT WITH RESPECT TO SUCH SECURITIES UNDER SUCH ACT AND ANY STATE APPLICABLE STATE SECURITIES LAWS OR AN OPINION OF COUNSEL SATISFACTORY TO THE COMPANY THAT SUCH REGISTRATION IS NOT REQUIRED.

iviewit Holdings, Inc.
Purchase Warrant for
Class B Non-Voting Common Stock

THIS WARRANT CERTIFICATE certifies that, FOR VALUE RECEIVED, Tiedemann Prolow, LLC, a New York limited liability company having an address of 535 Madison Avenue, 37th Floor, New York, NY 10022 (the "Holder"), is entitled, subject to the terms and conditions set forth in this Warrant Certificate for Purchase of Class B Non-Voting Common Stock (this "Warrant"), to purchase from iviewit Holdings, Inc., a Delaware corporation (the "Company"), up to One Thousand Seven Hundred Eighty (1,780) shares ("Warrant Shares") of Class B Non-Voting Common Stock, \$.01 par value, of the Company ("Class B Common Stock"), commencing on March _____, 2001, and ending at 5:00 p.m., Florida time, on March _____, 2006 (the "Expiration Date"), at an exercise price of One Hundred Fiftv-Five Dollars (\$155.00) per Warrant Share (the "Warrant Exercise Price"), such number of Warrant Shares and Warrant Exercise Price being subject to adjustment from time to time as set forth in Section 3 below. This Warrant may not be exercised after 5:00 p.m., Florida time, on the Expiration Date, at which time this Warrant, unless exercised prior thereto, shall thereafter be void.



EXHIBIT P



LETTER OF TONY FRENDEN, EX-VIDEO ENGINEER²⁹

March 28, 2002.

This is my recollection of the events last year which took place after the Iviewit staff was informed that the company would soon be closing, and we were all losing our jobs:

Shortly after a conference room meeting with people who Scott Murphy brought in, a video tape is brought into the lab. It is made clear that the tape belongs to Scott Murphy's associates, and I am instructed to give the utmost care and attention to encoding this tape, which is of pornographic nature. The number \$7 million is repeatedly mentioned as possible revenue should Iviewit get this pornography account. The tape is initially previewed in the lab when Mike Reale plays it in a VCR. I am present, along with Tammy Raymond, Network Administrator, and Courtney Jurcak, a teenage female technician. I believe Matthew Mink was also there. The tape is played using zero discretion. I am instructed to do my best in encoding this material, because as it was put to me, the deal could possibly serve in saving the company and everyone's job. To make clear, this episode all happened after a conference room meeting, in which Brian Utley announced to all Iviewit employees that the company was closing, effective immediately. After this announcement, and before the porno tape came in, my self-given job responsibilities included make closure to the Iviewit Boca Raton lab by packing away equipment for West Coast shipment, and informing our current clients that we would be doing no more work for them. I ran a very generalized encoding session over the porno tape. I remember meeting one of the main slimeball porno guys during this general time. He pointed at my computer screen and told me he needed the videos to look better than they did so he could offer something on his porno sites that no one else had. I didn't bother to use any special proprietary processes on the video because I

²⁹ Emphasis supplied.

was not personally motivated to do a good job on the tape. Approximately, the next day, I am summoned to the conference room where sits Brian Utley and Raymond Hersh. There is a large TV web monitor at the end of the conference table connected to the Internet, and I am instructed to use it to play the porno video which I encoded, and was now streaming live from our streaming server. I play the video, they watch. Comment on various visualities from the encode. They ask me questions. I am slightly embarrassed and want no part of it, and made a decision to myself that had they asked me to do further work for this client, I would decline. I was very shocked at the casual demeanor of these two men during this conference room porno review. Up to that point, and since the day I began at the company, I was informed that Iviewit would never have anything to do with adult content. The technology simply would not be used for those avenues, and I was made aware that stockholders and board members specifically stipulated these points. **During this general time, (but a bit later, because I remember some of the other technicians had already worked their last day), Mike Reale brings in a gray suitcase into the lab. The suitcase is constructed of a very durable nature and locking mechanisms. He opens it in front of me, and it's the most money I've ever seen in my life. Tammy Raymond was there, and later claimed that she thought it was fake because there was so much of it, but I was inches from it, and it looked like perfectly real stacks and stacks of one hundred dollar bills, and neatly arranged like in the movies. I asked Reale where this came from. I don't remember whom he said, but it was a name familiar to me as someone who didn't work in our office but had direct investment relations with Iviewit.**

I swear the above to be true and complete, to the best of my recollection.

Anthony Frenden
841 Manhattan Avenue #9
Hermosa Beach CA 90254



EXHIBIT Q



DEPOSITION OF MR. BERNSTEIN

5 A. I want to answer that, because the documents --
6 the corporate record was supposed to be transferred in its
7 entirety to the corporation in California by Mr. Utley, and
8 such documents in their entirety and computers containing
9 such documents in their entirety were not transferred to
10 the corporation timely or at all.

11 Then, it is the company's position, I guess that
12 we have to take, is that we are not in possession of our
13 own records because the people who were supposed to
14 transfer them did not transfer the documents to the company
15 as directed by the board of directors.

16 Q. So that's your evidence that Mr. Wheeler destroyed
17 the minutes of the board of directors meetings, the fact
18 that they never showed up when they were supposed to show
19 up to -- by Utley?

20 A. And they're not here --

21 Q. So Wheeler destroyed them?

22 A. -- for many of the meetings -- for many of the
23 meetings that Chris was keeping notes for, yes, I did not
24 find them here. So no, they might not be destroyed, they
25 might be on the other shelves.

1 Q. Well, you are singing a completely different tune
2 than you were two minutes ago.

3 A. No. I'm just saying that if they were part of th
4 work that was on this table, and that they were part of th
5 corporate record that was transferred, many of the minutes
6 of the board meeting are destroyed at this point. We do
7 not have them, possession of them --

8 Q. That means they're destroyed?

9 A. -- and the people in charge of them are not
10 presenting them to us, so they might be in hiding from us.
11 Okay. But I -- to me, they company, they're destroyed,
12 gone, not existent. They're not part of our corporate
13 record.

14 Q. So when you said "destroyed" about documents in
15 this deposition, you meant that you didn't have them; you
16 don't know for a fact that they were actually destroyed?
17 Do you know what destroyed means?

18 A. Well, to us it means --

19 Q. What does destroy mean to you?

20 A. Okay. To the company, we asked for --

21 Q. I don't care about the company. I want to know
22 what Simon Bernstein thinks -- Eliot Bernstein thinks
23 destroyed means.

24 A. Missing from your records, not provided when
25 requested. Missing documents would, to me, represent a

1 destruction of documents.

2 Also, on the destruction side of documents, is the
3 locking out of computer domains and files with the intent
4 so that documents --

5 Q. All I asked you is what destroyed means to you.

6 A. Well, I'm explaining. You know, are the board
7 notes and damaged hard drives or stolen computers that were
8 taken to New Jersey by Mr. Utley; could be, but I'm not --

9 Q. See, when you say Mr. Wheeler destroyed documents,
10 most people would frame an image of a man going over to a
11 shredding machine and putting documents in a shredding
12 machine. But you're saying it means something completely
13 different --

14 A. No. I'm saying that unless they ended up -- we
15 just went through this a little while ago in the
16 deposition, but you said all of the documents were here at
17 this table.

18 Q. Did you say in that counterclaim that Proskauer
19 destroyed documents?

20 A. I am not sure. I believe so. Do we --

21 MR. SELZ: I don't think so.

22 MR. PRUSASKI: Let me see it.

23 A. No.

24 Q. Why didn't you say it in there if it happened?

25 A. I was busy listing the key things.

1 Q. Destroying documents by a law firm isn't very key
2 to you?

3 A. I've notified my counsel that that occurred long
4 ago, so he might have overlooked it in filing the claim to
5 get it on based on the evidence --

6 Q. Okay. So you're still sticking to your story tha
7 Proskauer destroyed documents?

8 A. I'm -- because they're missing, in my
9 interpretation --

10 Q. Because he's missing them -- you let your attorne
11 know, but you didn't put it in the counterclaim?

12 A. Well, he has a lot of it, you know. Yes, I would
13 say --

14 Q. So you are still sticking to your story that
15 Proskauer destroyed documents --

16 A. In my interpretation --

17 Q. -- but you have no personal knowledge of whether
18 they did?

19 A. -- of the word destruction, because they are not
20 present in any records that the company can now get, yes,
21 they have been, since Mr. Wheeler was keeping records of
22 them.

23 Q. So destroyed means missing to you?

24 A. Yes.

25 MR. PRUSASKI: Right. Why don't you go buy a



1 dictionary? There's a Barnes & Noble down the
2 street.
3 I have no further questions. Thank you.
4 THE WITNESS: Okay.
5 Does he want to read or waive?
6 MR. SELZ: He'll read. Hold the
7 transcript.
8 (Thereupon, the deposition was concluded
9 at 4:29 p.m.)
10



EXHIBIT R



GENERAL LEDGER – BILLING OF PROSKAUER

* LEDGER HISTORY *

May 28 2002
16:49:54

CLIENT: 40017

IVIEWIT.COM, INC.

TYPE	NUMBER	DATE	FEES	COSTS/ OTHER	UNALLOCATED	TOTAL
BILL	320581	06/18/99	64837.50	1814.95	.00	<u>66652.45</u>
PAY	320581 1028	09/22/99	-64837.50	-1814.95	.00	-66652.45
BILL	324595	06/30/99	.00	.00	.00	.00
BILL	324596	06/30/99	.00	.00	.00	.00
BILL	324597	06/30/99	.00	.00	.00	.00
BILL	324598	06/30/99	.00	.00	.00	.00
BILL	324599	06/30/99	.00	.00	.00	.00
BILL	327337	08/24/99	92630.00	6248.10	.00	<u>98878.10</u>



EXHIBIT S



PATENT DRAFT CHANGES OF COMPANY

57103/111

DRAFT

PCT INTERNATIONAL PATENT APPLICATION

for

SYSTEM AND METHOD FOR PROVIDING

AN ENHANCED DIGITAL VIDEO FILE

Inventors:

Eliot I. Bernstein
[home address]
[citizenship]

Zachiryl Shivajee
[home address]
[citizenship]

Jude Rosario
[home address]
[citizenship]

Sp. 2
Su 40
Bin 1

FOLEY & LARDNER
Attorneys at Law
777 E. Wisconsin Avenue
Milwaukee, Wisconsin 53202
(414) 271-2400



**INTELLECTUAL PROPERTY DOCKET OF BLAKELY, SOKOLOFF, TAYLOR
& ZAFMAN LLP**

VIEWIT.COM PATENT STATUS REPORT

05707

TITLE	MATTER	INVENTOR/ PATENTEE	COUNTRY	SERIAL NO./ PATENT NO.	FILED/ISSUE DATE	ASSIGNEE
Apparatus and Method for Producing Enhanced Digital Images	P001 (fka102)	Eliot I. Bernstein	United States	Serial No. 60/125824	Filed 03/24/99	Bernstein to Iviewit LLC to Iviewit Holdings, Inc. Assigned: 01/06/00 Reel/Frame: 010523/0526
Apparatus and Method for Producing Enhanced Video Images	P002 (fka 103)	Eliot I. Bernstein	United States	Serial No. 60137,297	Filed 06/03/99	Bernstein to Iviewit LLC to Iviewit Holdings, Inc. Assigned: 01/06/00 Reel/Frame: 010523/0494
Apparatus and Method for Playing Video Files Across the Internet	P003 (fka 104)	Eliot I. Bernstein	United States	Serial No. 60/137,921	Filed 06/07/99	Bernstein to Iviewit LLC to Iviewit Holdings, Inc. Assigned: 01/06/00 Reel/Frame: 010523/0497
Apparatus and Method for Providing and/or Transmitting Video Data and/or Information in a Communication Network	P004 (fka 105)	Eliot I. Bernstein	United States	Serial No. 60/141,440	Filed 06/29/99	Iviewit Holdings, Inc. Assigned: 01/03/00 Reel/Frame: 010523/0574
Apparatus and Method for Producing Enhanced Digital Images	P005 (fka 106)	Eliot I. Bernstein	United States	Serial No. 60/146,726	Filed 08/02/99	Iviewit Holdings, Inc. Assigned: 01/06/00 Reel/Frame: 010523/0509
Apparatus and Method for Producing Enhanced Digital Images and/or Digital Video Files	P006 (fka 107)	Eliot I. Bernstein	United States	Serial No. 60/149,737	Filed 08/19/99	Iviewit Holdings, Inc. Assigned: 01/06/00 Reel/Frame 010523/0506
Apparatus and Method for Producing Enhanced Video Images and/or Video Files	P007 (fka 108)	Eliot I. Bernstein	United States	Serial No. 60/155,404	Filed 09/22/99	Iviewit Holdings, Inc. Assigned: 01/06/00 Reel/Frame 010523/0183



VIEWIT.COM PATENT STATUS REPORT

05707

TITLE	MATTER	INVENTOR/ PATENTEE	COUNTRY	SERIAL NO./ PATENT NO.	FILED/ISSUE DATE	ASSIGNEE
Apparatus and Method for Producing Enhanced Video Images and/or Video Files	P008 (fka 109)	Eliot I. Bernstein	United States	Serial No. 60/169,559	Filed 12/08/99	Iviewit Holdings, Inc Assigned: 01/06/00 Reel/Frame 010523/0220
Apparatus and Method for Producing Enhanced Digital Images	P009PCT (fka 110)	Eliot I. Bernstein	Patent Cooperation Treaty	Serial No. PCT/US00/07 772	Filed 03/23/00 Priority 03/24/99	Not assigned.
System and Method for Streaming an Enhanced Digital Video File	P010PCT (fka 111)	Eliot I. Bernstein	Patent Cooperation Treaty	Serial No. PCT/US00/15 408	Filed 06/02/00	Not assigned.
System and Method for Providing an Enhanced Digital Video File	P011PCT (fka 112)	Eliot I. Bernstein	Patent Cooperation Treaty	Serial No. PCT/US00/15 405	Filed 06/02/00 Priority 03/06/99	Applicant Iviewit Holdings, Inc.
System and Method for Playing a Digital Video File	P012PCT (fka 113)	Eliot I. Bernstein	Patent Cooperation Treaty	Serial No. PCT/US00/15 406	Filed 06/02/00 Priority 03/06/99	Applicant Iviewit Holdings, Inc.
System and Method for Streaming an Enhanced Digital Video File	P013 (fka 114)	Eliot I. Bernstein Zakirul A. Shirajee	United States	Serial No. 09/587,730	Filed 06/05/00	Applicant Iviewit Holdings, Inc.
System and Method for Playing a Digital Video File	P014 (fka 115)	Eliot I. Bernstein Zakirul A. Shirajee	United States	Serial No. 09/587,026	Filed 06/05/00	Applicant Iviewit Holdings, Inc.

Blakely, Sokoloff, Taylor & Zafman



VIEWIT.COM PATENT STATUS REPORT

05707

TITLE	MATTER	INVENTOR/ PATENTEE	COUNTRY	SERIAL NO./ PATENT NO.	FILED/ISSUE DATE	ASSIGNEE
System and Method for Providing An Enhanced Digital Video File	P015 (fka 116)	Eliot I. Bernstein Brian G. Utley Jude K. Rosario	United States	Serial No. 09/587,734	Filed 06/05/00	Applicant Iviewit Holdings, Inc.
System and Method for Video Playback Over a Network	P016PCT (fka 118)	Eliot I. Bernstein	PCT	Serial No. PCT/US00/15 602	Filed 06/07/00	Applicant Iviewit Holdings, Inc.
Apparatus and Method for Producing Enhanced Digital Images	P017 (fka 119)	Eliot I. Bernstein	United States	Serial No. 09/522,721	Filed 03/10/00	Not assigned
System and Method for Providing an Enhanced Digital Image File	P018PCT (fka 120)	Eliot I. Bernstein	PCT	Serial No. PCT/US00/21 211	Filed 08/02/00	Applicant Iviewit Holdings, Inc.
System and Method for Providing and Enhanced Digital Image File	P019 (fka 121)	Eliot I. Bernstein Brian Utley	United States	Serial No. 09630,939	Filed 08/02/00	Not assigned.
Zoom and Pan Imaging Using a Digital Camera	P020 (fka 122)	Brian Utley	United States	Serial No. 60/223,344	Filed 09/18/00	Not assigned.
Zoom and Pan Imaging Design Tool	P021 (fka 123)	Brian Utley	United States	Serial No. 60/233,341	Filed 09/18/00	Not assigned.

Blakely, Sokoloff, Taylor & Zafman

3



EXHIBIT T



MOTION AND COUNTERCLAIM³⁰

³⁰ Proskauer Rose LLP v. Iviewit.com, Inc. et. al., Case No. CA 01-04671 AB (Circuit Court of the 15th Judicial Circuit in and for Palm Beach County, Florida filed May 2, 2001)

IN THE CIRCUIT COURT OF THE
15TH JUDICIAL CIRCUIT IN AND
FOR PALM BEACH COUNTY,
FLORIDA

PROSKAUER ROSE L.L.P.,
a New York limited partnership,

CA 01-04671 AB

Plaintiff,

v.

IVIEWIT.COM, INC., a Delaware
corporation, IVIEWIT HOLDINGS,
INC., a Delaware corporation, and
IVIEWIT TECHNOLOGIES, INC.,
a Delaware corporation.

Defendants.

COPY / ORIGINAL
RECEIVED FOR FILING

JAN 28 2003

DOROTHY H. WILKEN
CLERK OF CIRCUIT COURT
CIRCUIT CIVIL DIVISION

**DEFENDANTS MOTION FOR LEAVE TO AMEND TO ASSERT
COUNTERCLAIM FOR DAMAGES**

Defendants, IVIEWIT.COM, INC., IVIEWIT HOLDINGS,
INC. and IVIEWIT TECHNOLOGIES, INC., by and through their undersigned
counsel, hereby move this Court for Leave to Amend their Answer so as to assert a
counterclaim in this matter pursuant to Rule 1.170(f) of the Florida Rules of Civil
Procedure and as grounds therefore would state as follows:

1. That the Defendants move to amend their answer in this matter so as to
include a counterclaim in this matter, which by its nature appears to be a compulsory
counterclaim to the extent that the issues arise out of the same nexus of events, as

justice requires that the counterclaim be tried at the same time as the complaint and answer so that all pending issues between the parties may be adjudicated in this action.

2. That as a result of fact that additional evidence in support of the Defendants' counterclaims is found in the Plaintiff's own files and records, the Plaintiff will not be prejudiced by the amendment of the Defendants' answer in this matter, nor will this matter be delayed as to the trial of same.

3. Defendants have attached hereto a copy of the proposed counterclaim.

WHEREFORE the Defendants, move this Honorable Court for the entry of an order permitting the Defendants to amend their answer in this matter.

I HEREBY CERTIFY that a true and correct copy of the foregoing has been provided by U.S. Mail and fax transmission this 28th day of January, 2003 to: Christopher W. Prusaski, Esq., Proskauer Rose, LLP, 2255 Glades Road, Suite 340 W, Boca Raton, FL 33431.

SELZ & MUVDI SELZ, P.A.
214 Brazilian Avenue, Suite 220
Palm Beach, FL 33480
Tel: (561) 820-9409
Fax: (561) 833-9715

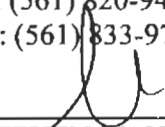
By: 

STEVEN M. SELZ
FBN: 777420

IN THE CIRCUIT COURT OF THE
15th JUDICIAL CIRCUIT IN AND
FOR PALM BEACH COUNTY,
FLORIDA

PROSKAUER ROSE, LLP, a New York
limited partnership,

CASE NO.: CA 01-04671 AB

Plaintiff,

vs.

IVIEWIT.COM, INC., a Delaware
corporation, IVIEWIT HOLDINGS,
INC., a Delaware corporation and,
IVIEWIT TECHNOLOGIES, INC.,
a Delaware corporation,

Defendants,

COUNTERCLAIM FOR DAMAGES

COME NOW the Counter Plaintiffs, IVIEWIT.COM, INC., IVIEWIT HOLDINGS, INC., IVIEWIT TECHNOLOGIES, INC. and IVIEWIT LLC, hereinafter collectively referred to as “IVIEWIT” or Counter Plaintiffs, and hereby sues Counter Defendant, PROSKAUER ROSE, LLP, hereinafter “PROSKAUER”, a New York limited partnership, and alleges as follows:

GENERAL ALLEGATIONS COMMON TO ALL COUNTS

1. This is an action for damages in a sum greater than \$15,000.00, exclusive

of interest, taxable costs and attorneys fees.

2. Counter Plaintiff, IVIEWIT.COM, INC., is a Delaware corporation, formed by PROSKAUER, which at all times relevant hereto was authorized to conduct and conducted business in Palm Beach County Florida and the State of California.

3. Counter Plaintiff, IVIEWIT HOLDINGS, INC., is a Delaware corporation, formed by PROSKAUER, which at all times relevant hereto was authorized to conduct and conducted business in Palm Beach County Florida and California.

4. Counter Plaintiff, IVIEWIT TECHNOLOGIES, INC., is a Delaware corporation, formed by PROSKAUER, which at all times relevant hereto was authorized to conduct and conducted business in Palm Beach County Florida and the State of California.

5. IVIEWIT LLC, is a Florida limited liability company, formed by PROSKAUER, which, at all times relevant hereto, was authorized to conduct and conducted business in the Palm Beach County Florida and the State of California.

6. Counter Defendant PROSKAUER ROSE, LLP, (hereinafter "PROSKAUER") is a New York limited partnership, operating a law office in Boca Raton, Palm Beach County, Florida.

Boca Raton, Palm Beach County, Florida.

7. BRIAN G. UTLEY, (hereinafter “UTLEY”) was at all times relevant hereto a sui juris resident of the State of Florida and who on or about September of 1999 was the president of Counter Plaintiff, IVIEWIT LLC.

8. CHRISTOPHER WHEELER, (hereinafter “WHEELER”) is a sui juris individual and resident of Palm Beach County, Florida, who at all times relevant hereto was a partner of PROSKAUER and who provided legal services to the Counter Plaintiffs.

9. KENNETH RUBENSTEIN, (hereinafter “RUBENSTEIN”) is a sui juris individual believed to be a resident of the State of New York and who various times relevant hereto was initially misrepresented by WHEELER as a partner of PROSKAUER and later became a partner of PROSKAUER, and who provided legal services to the Counter Plaintiffs both while at Meltzer, Lippie, et al., and PROSKAUER.

10. RAYMOND JOAO, (hereinafter “JOAO”) is a sui juris individual believed to be a resident of the State of New York and who at all times relevant hereto was represented to be RUBENSTEIN’s associate at PROSKAUER, when in fact JOAO has never been an employee of PROSKAUER but in fact was an employee of Meltzer, Lippie, et al.

11. That beginning on or about November of 1998, the Counter Plaintiff, IVIEWIT, through it's agent and principal, Eliot I. Bernstein ("Bernstein"), held discussions with WHEELER with regard to PROSKAUER providing legal services to the company involving specific technologies developed by Bernstein and two others, which technologies allowed for:

i) Zooming of digital images and video without degradation to the quality of the digital image due to what is commonly refereed to as "pixilation"; and,

ii) The delivery of digital video using proprietary scaling techniques; and,

iii) A combination of the image zoom techniques and video scaling techniques described above; and,

iv) The remote control of video cameras through communications networks.

12. That Bernstein engaged the services of PROSKAUER to provide legal services to the company to be formed, including corporate formation and governance for a single entity and to obtain multiple patents and oversee US and foreign filings for such technologies including the provisional filings for the technologies as described in Paragraph 11 above, the "Technology", and such

other activities as were necessary to protect the intellectual property represented by the Technology.

13. That at the time of the engagement of PROSKAUER, Bernstein was advised and otherwise led to believe that WHEELER was the PROSKAUER partner in charge of the account.

14. Upon information and belief, WHEELER, RUBENSTEIN and JOAO upon viewing the technologies developed by Bernstein, and held by IVIEWIT, realized the significance of the technologies, its various applications to communication networks for distributing video data and images and for existing digital processes, including, but not limited to digital cameras, digital video disks (DVD), digital imaging technologies for medical purposes and digital video, and that WHEELER, RUBENSTEIN and JOAO conspired to undertake and in fact undertook a deliberate course of conduct to deprive Bernstein and IVIEWIT of the beneficial use of such technologies for either the use of third parties, who were other clients of PROSKAUER and WHEELER, or for WHEELER, RUBENSTEIN and JOAO's own financial gain, to the detriment and damage of the Counter Plaintiffs.

15. That WHEELER, who was a close personal friend of UTLEY, recommended to Bernstein and other members of the board of directors of

IVIEWIT that the IVIEWIT engage the services of UTLEY to act as President of the Iviewit.com, LLC based on his knowledge and ability as to technology issues.

16. That at the time that WHEELER made the recommendation of UTLEY to the board of directors, that WHEELER knew that UTLEY was in a dispute with his former employer, Diamond Turf Products and the fact that UTLEY had misappropriated certain patents on hydro-mechanical systems to the detriment of Diamond Turf Products.

17. Additionally, WHEELER was fully aware of the fact that UTLEY was not the highly qualified “engineer” that UTLEY represented himself to be, and that in fact UTLEY lacked real engineering expertise or even an engineering degree and that UTLEY had been fired from Diamond Turf Products due to his misappropriation of patents.

18. That despite such knowledge, WHEELER never mentioned such facts concerning UTLEY to any representative of IVIEWIT and in fact undertook to “sell” UTLEY as a highly qualified candidate who would be the ideal person to undertake day to day operations of IVIEWIT and work on the patents, acting as a qualified engineer.

19. Additionally, WHEELER continued to assist UTLEY in perpetrating such fraud on both the Board of Directors of IVIEWIT and to third parties,

including Wachovia Bank, by approving a false resume for UTLEY to be included in seeking approval of a private placement for IVIEWIT.

20. That based on the recommendations of WHEELER, as partner of PROSKAUER, the board of directors agreed to engage the services of UTLEY as president.

21. That almost immediately after UTLEY's employment and almost one year after initially providing of services, WHEELER provided a retainer agreement for the providing of services by PROSKAUER to IVIEWIT LLC, addressed to UTLEY, a true and correct copy of such retainer agreement (the "Retainer") being attached hereto and made a part hereof as Exhibit "A". That the services provided were in fact to be paid out of the royalties recovered from the use of the Technology, which was to be included in patent pools overseen by RUBENSTEIN.

22. That the Retainer by its terms contemplated the providing of corporate and general legal services to IVIEWIT LLC by PROSKAUER and was endorsed by UTLEY on behalf of IVIEWIT LLC, the Board of Directors of IVIEWIT LLC would not have UTLEY authorized to endorse same as it did not include the intellectual property work which PROSKAUER had already undertaken.

23. That prior to the Retainer, PROSKAUER and WHEELER had provided

legal services to IVIEWIT, including services regarding patent procurement and acted to coordinate such services both internally and with outside counsel, including RUBENSTEIN and JOAO, including times when they were misrepresented as PROSKAUER attorneys.

24. That PROSKAUER billed IVIEWIT for legal services related to corporate, patent, trademark and other work in a sum of approximately \$800,000.00.

25. That PROSKAUER billed IVIEWIT for legal service never performed, double-billed by the use of multiple counsel on the same issue, and systematically overcharged for services provided.

26. That summaries of the billing statements provided by PROSKAUER to IVIEWIT are attached hereto and made a part hereof as Exhibit "B".

27. That based on the over-billing by PROSKAUER, IVIEWIT paid a sum in of approximately \$500,000.00 plus together with a 2.5% interest in IVIEWIT, which sums and interest in IVIEWIT was received and accepted by PROSKAUER.

28. That WHEELER, UTLEY, RUBENSTEIN, JOAO and PROSKAUER, conspired to deprive IVIEWIT of its rights to the technologies developed by Bernstein by:

a) Transferring patents using Foley & Lardner so as to name UTLEY as the sole holder of multiple patents in his individual name and capacity when in fact they were and arose from the technologies developed by Bernstein and others and held by IVIEWIT prior to UTLEY's employment with IVIEWIT, and;

b) Upon discovery of the "lapses" by JOAO, that WHEELER and PROSKAUER referred the patent matters to WILLIAM DICK, of Foley & Lardner, who was also a close personal friend of UTLEY and who had been involved in the diversion of patents to UTLEY at Diamond Turf Products; and,

c) Failing to list proper inventors of the technologies based on improper legal advise that foreign inventors could not be listed until their immigration status was adjusted, resulting in the failure of the patents to include their rightful and lawful inventors and the payment by IVIEWIT for unnecessary immigration work; and,

d) Failing to ensure that the patent applications for the technologies, contained all necessary and pertinent information relevant to the technologies and as required by law; and,

e) Failing to secure trademarks and copyrights and failing to complete trademark and copyright work for the use of proprietary names of IVIEWIT and source code for the Technologies of IVIEWIT as intellectual property, and;

f) Allowing the infringement of patent rights of IVEIWIT and the intellectual property of IVIEWIT by other clients of PROSKAUER and WHEELER, and;

g) Aiding JOAO in filing patents for IVIEWIT intellectual property by intentionally withholding pertinent information from such patents and not filing same timely, so as to allow JOAO to apply for similar patents in his own name, both while acting as counsel for IVIEWIT and subsequently.

29. As a direct and proximate result of the actions of the Counter Defendant, Counter Plaintiffs have been damaged in a sum estimated to be greater than \$10,000,000,000.00, based on projections by Gerald Stanley, CEO of Real 3-D (a consortium of Lockheed, Silicone Graphics and Intel) as to the value of the technologies and their applications to current and future uses together with the loss of funding from Crossbow Ventures as a result of such conduct.

30. All conditions precedent to the bringing of this action have occurred or have been waived or excused.

COUNT I- LEGAL MALPRACTICE

31. This is an action for legal malpractice within the jurisdiction of this court.

32. Counter Plaintiff re-alleges and hereby incorporates that allegations of Paragraphs 1 through 30 as if fully set forth herein.

33. PROSKAUER employed by IVIEWIT for purposes of representing IVIEWIT to obtain multiple patents and oversee foreign filings for such technologies including the provisional filings for the technologies as described in Paragraph 11 above.

34. That pursuant to such employment, PROSKAUER owed a duty to ensure that the rights and interests of IVIEWIT were protected.

35. WHEELER, RUBENSTEIN, JOAO and PROSKAUER neglected that reasonable duty of care in the performance of legal services in that they:

a) Failed to take reasonable steps to ensure that the intellectual property of IVIEWIT was protected; and,

b) Failed to complete work regarding copyrights and trademarks; and,

c) Engaged in unnecessary and duplicate corporate and other work resulting in billing for unnecessary legal services believed to be in excess of \$400,000.00; and,

d) By redacting information from the billing statements regarding services provided so to as to give the appearance that the services provided by PROSKAUER were limited in nature, when in fact they involved various aspects of intellectual property protection; and,

e) By knowingly representing and agreeing to accept representation of

clients in conflict with the interests of IVIEWIT, without either consent or waiver by IVIEWIT.

36. That the negligent actions of PROSKAUER and its partners, WHEELER and RUBENSTEIN, resulted in and was the proximate cause of loss to IVIEWIT.

WHEREFORE, Counter Plaintiff demands judgement for damages against Defendant together with reasonable attorneys fees, court costs, interest and such other and further relief as this Court deems just and equitable.

COUNT II- CIVIL CONSPIRACY

37. This is an action for civil conspiracy within the jurisdiction of this court.

38. Counter Plaintiff re-alleges and hereby incorporates that allegations of Paragraphs 1 through 30 as if fully set forth herein.

39. Defendant, PROSKAUER and UTLEY, WHEELER, RUBENSTEIN and JOAO, jointly conspired to deprive the Counter Plaintiffs of their rights and interest in the Technology.

40. That UTLEY, WHEELER, RUBENSTEIN, JOAO and PROSKAUER with such intent, directed that certain patent rights be put in the name of UTLEY and/or that such patent rights were modified or negligently pursued so as to fail to provide protection of the intellectual property, resulting in the ability of other clients of WHEELER, RUBENSTEIN, JOAO and PROSKAUER to make use of such

technologies without being liable to IVIEWIT for royalties normally arising from such use.

41. That PROSKAUER, without either consent of the Board of Directors or proper documentation, transferred securities to Tiedemann/Prolow Investment Group, which entity was also referred to by WHEELER, who acted as counsel for such unauthorized transaction.

42. That upon the discovery of the above-described events and conspiracy, IVIEWIT's lead investor, Crossbow Ventures, ceased its funding of IVIEWIT.

43. That Crossbow Ventures, which was a referral of WHEELER, took a security interest in the Technology under the guise of protecting IVIEWIT and its shareholders from the actions of UTLEY, based on the filing of an involuntary bankruptcy (which was later withdrawn), and as to WHEELER and PROSKAUER based on the instant law suit, when in fact such conduct was motivated by Crossbow's attempts to wrongfully detain the interests of IVIEWIT in the Technology. Such conduct, upon information and belief, was undertaken with the knowledge and assistance of WHEELER and PROSKAUER.

44. As a direct and proximate result of the conspiracy and acts of PROSKAUER, UTLEY, WHEELER, JOAO and RUBENSTEIN, the Counter Plaintiffs have been damaged.

WHEREFORE, Counter Plaintiffs demand judgement for damages against Defendant together with court costs, interest and such other and further relief as this Court deems just and equitable.

COUNT III- BREACH OF CONTRACT

45. This is an action for breach of contract within the jurisdiction of this Court.

46. Counter Plaintiff re-alleges and hereby incorporates that allegations of Paragraphs 1 through 30 as if fully set forth herein.

47. Defendant, PROSKAUER, breached the contract with Counter Plaintiff, IVIEWIT LLC by failing to provide services billed for pursuant to the billing statements presented to the Counter Plaintiffs and over-billing for services provided.

48. That such actions on the part of PROSKAUER constitute beaches of the contract by and between IVIEWIT LLC and PROSKAUER.

49. That as a direct and proximate result of such conduct on the part of PROSKAUER, IVIEWIT LLC has been damaged by overpayment to PROSKAUER and the failure of PROSKAUER to perform the contracted for legal services.

WHEREFORE, IVIEWIT demands judgement for damages against Counter Defendant together with court costs, interest and such other and further relief as this Court deems just and equitable.

**COUNT IV- TORTIOUS INTERFERENCE WITH AN ADVANTAGEOUS
BUSINESS RELATIONSHIP**

50. This is an action for tortious interference with an advantageous business relationship within the jurisdiction of this Court.

51. Counter Plaintiff re-alleges and hereby incorporates that allegations of Paragraphs 1 through 30 as if fully set forth herein.

52. Counter Plaintiff was engaged in negotiations of technology agreements with both Warner Bros. and AOL/Time Warner as to the possible use of the Technologies of the Counter Plaintiffs and investment in Counter Plaintiffs as a strategic partner.

53. That despite the prior representations of RUBENSTEIN, at a meeting held on or about November 1, 2000, by and between UTLEY, RUBENSTEIN and representatives of Warner Bros. as to the Technology of IVIEWIT and the efficacy, novelty and unique methodology of the Technology, RUBENSTEIN refused to subsequently make the same statements to representatives of AOL and Warner Bros., taking the position that since Warner Bros./AOL is “now a big client of Proskauer, I can’t comment on the technologies of Iviewit.” or words to that effect in response to inquiry from Warner Brother/AOL’s counsel as to the status and condition of the pending patents on the intellectual property.

54. That RUBENSTEIN, having served as an advisor to the Board of Directors for IVIEWIT, was aware of the fact that at the time of the making of the statements set forth in Paragraph 50, above, IVIEWIT was in the midst of negotiations with AOL/Warner Bros. as to the possible funding of the operations of IVIEWIT in and sum of between \$10,000,000.00 and \$20,000,000.00.

55. Further, RUBENSTEIN as a partner of PROSKAUER, and despite his clear prior actions in representing the interests of IVIEWIT, refused to answer questions as to the enforcement of the Technology of IVIEWIT, with the intent and knowledge that such refusal would lead to the cessation of the business relationship by and between IVIEWIT and Warner Bros./AOL and other clients familiar with the Warner Bros./AOL technology group then in negotiations with IVIEWIT, including, but not limited to Sony Corporation, Paramount, MGM and Fox.

56. That the actions of RUBENSTEIN were and constituted an intentional and unjustified interference with the relationship by and between IVIEWIT and Warner Bros./AOL designed to harm such relationship and further motivated by the attempts to “cover-up” the conflict of interest in PROSKAUER’s representation of both IVIEWIT and Warner Bros./AOL.

57. That indeed, as a direct and proximate result of the conduct of RUBENSTEIN, Warner Bros./AOL ceased business relations with IVIEWIT to the

damage and detriment of Counter Plaintiffs.

WHEREFORE, Counter Plaintiffs demand judgement for damages against Counter Defendant together with court costs, interest and such other and further relief as this Court deems just and equitable.

I HEREBY CERTIFY that a true and correct copy of the foregoing has been provided by U.S. Mail and fax transmission this 20th day of January, 2003 to: Christopher W. Prusaski, Esq., Proskauer Rose, LLP, 2255 Glades Road, Suite 340 W, Boca Raton, FL 33431.

SELZ & MUVDI SELZ, P.A.
214 Brazilian Avenue, Suite 220
Palm Beach, FL 33480
Tel: (561) 820-9409
Fax: (561) 833-9715

By: 

STEVEN M. SELZ
FBN: 777420



EXHIBIT U



Calculated Discount Rate:	12.00%				
	<u>Year 1</u>	<u>Year 2</u>	<u>Year 3</u>	<u>Year 4</u>	<u>Year 5</u>
Revenue Potential					
<i>Device OEM Licensing</i>	\$387,491,845	\$410,385,714	\$435,344,087	\$485,758,798	\$543,018,985
<i>Motion Picture Video on Demand ("VOD") Licensing</i>	4,260,793	4,778,426	5,648,251	7,151,662	9,707,205
<i>DVD Encoding/Replication</i>	383,471,325	430,058,359	508,342,628	643,649,599	873,648,447
<i>Appliances (copiers, printers, etc.)</i>	290,618,884	307,789,285	326,508,066	364,319,098	407,264,239
<i>Other Device OEM's (scanners, game boxes, e-books, etc.)</i>	96,872,961	102,596,428	108,836,022	121,439,699	135,754,746
<i>Delivery Systems (terrestrial, ISP, Wireless, etc.)</i>	387,491,845	0	0	0	0
<i>Medical Imaging and Devices</i>	116,247,554	123,115,714	130,603,226	145,727,639	162,905,696
<i>Wireless Devices</i>	271,244,292	287,270,000	304,740,861	340,031,159	380,113,290
<i>Enterprise Software</i>	191,735,663	215,029,179	254,171,314	321,824,799	436,824,224
<i>Internet (auctions, retail games, etc.)</i>	<u>191,735,663</u>	<u>215,029,179</u>	<u>254,171,314</u>	<u>321,824,799</u>	<u>436,824,224</u>
Present Value – Total Revenue Potential	1,875,454,356	1,670,960,048	1,657,584,195	1,749,351,147	1,921,901,867
Present Value – Cumulative Revenue Potential	<u>1,875,454,356</u>	<u>3,546,414,404</u>	<u>5,203,998,599</u>	<u>6,953,349,746</u>	<u>8,875,251,614</u>
Present Value – Cum. Rev. Pot. Over 20-Year Patent Life	\$17,353,552,076				
Assume Percentage of Unsuccessful U.S. Patent Repair	\$6,802,592,414				
Assume Percentage of Forfeiting PCT Protection	<u>3,470,710,415</u>				
Cum. Potential Damages Over 20-Year Patent Life	<u>\$10,273,302,829</u>				



EXHIBIT V

LETTER OF MR. COLTER

Subj: **iviewit**

Date: 10/25/2001 12:08:38 AM Pacific Daylight Time

From: David Colter@warnerbros.com (DColter0264)

To: gt@22wain.com

Sent on: AOL 6.0 for Windows US sub 10539

Greg,

I wanted to give you an update on iviewit, since we will be missing each other until the 7th of Nov (vacation next week).

Eliot's erratic behaviour regarding the NDA was anything but erratic. I have since learned from a number of sources that Eliot believed we were part of, and supporting a pre-packaged bankruptcy for the company that would clean out the current investors (mostly friends and family who had their investment considered as unsecured debt for tax protections I believe) and leave Crossbow, it's friends, the original patent attorneys and Aidan with majority control of the IP -- wiping out Eliot and many people I know and care about.

Aidan told Eliot that we had agreed with this plan -- hence Eliot's behaviour at that time. I have also talked with a number of people who are involved with iviewit -- Alan Epstein, Aidan, Hank, etc -- and the story seems fairly clear, and I believe that inappropriate actions have taken place -- the primary investor has been running the company, and seems to have engineered all of the investment as debt to force the BK, and gain control of the IP from it's inventor. I have learned a lot more about business this week, that I would rather not need to know.

John Calkins, Clarissa Weirick and I met with Eliot and Aidan last Friday. John was surprised at Crossbow and Aidan's actions, when all of the patent opinions look very favorable, and when we have been waiting for a business plan since February to take to Heidi Krauel at AOLTW Ventures. John wants to arrive at an investment decision in 6 weeks, and the primary task is the assessment of the patents. You are probably the best one to answer some of the questions:

- Ken Rubenstein was one of the original attorneys who looked at the patents and whose firm in FL filed the originals -- should we approach Ken for an opinion?

- Zaffman provided what seems like a very strong opinion. Would you take a look at it and provide your perspective? I can send under another cover.

- If we end up with a percentage ownership of the IP, how does that impact our ability to leverage in patent pools? Do we need to have full control.

Your input is very important.

Additionally, I know you provided Aidan a good perspective on licensing. I want to suggest that you should talk with Alan Epstein, and possibly Eliot, before dealing with him in the future. I am concerned that he has been less than honorable in his dealings with Eliot, iviewit and ourselves. I am not completely certain, but have a bad

feeling based on many people's views on what is happening to iviewit. I would be very interested in your opinion on this.

Hopefully, we can talk about this when you are back... I would be happy to chat from my vacation in Orlando... Eliot is a friend and I want to explore all options to help.

Travel safe and take care.

Thank,
David



EXHIBIT W



DEPOSITION OF RESPONDENT

1 A. Right.

2 Q. Did you ever advise anyone at iviewit
 3 other than, obviously, Mr. Utley, who knew that you
 4 had represented him in the past, that you had
 5 represented Mr. Utley at one point?

6 A. No.

7 Q. Was there any - any question of any
 8 conflict?

9 A. No.

DEPOSITION OF MR. UTLEY

Proskauer Rose, et al. vs Iviewit.Com, Inc., et al. 8/22/02

Q. Okay. Other than that, he never
 represented you as an attorney; he never
 represented you in any case, nothing of that
 sort?

A. No.

RESPONDENT'S RESPONSE TO COMPLAINT

V. No Conflicts Of Interest Existed In Proskauer's Representation Of Iviewit

Mr. Bernstein also alleges the existence of a conflict of interest on the part of Mr. Wheeler based on his prior representation of Mr. Utley in other matters. At the time Mr. Wheeler introduced Mr. Utley to Mr. Bernstein, Mr. Wheeler disclosed that Proskauer had previously formed a corporation for Mr. Utley in approximately 1993. At the time the introduction was made, Mr. Utley was not a current client of the firm. In short, there was no conflict of interest arising out of Mr. Wheeler merely introducing Mr. Utley to Iviewit.



Lorraine Christine Hoffman, Esq.
Assistant Staff Counsel
The Florida Bar
File No. 2003-51, 109(15C)

THIS MESSAGE AND ITS EMBEDDED FILES INCORPORATED HEREIN CONTAIN INFORMATION THAT IS PROPRIETARY AND CONFIDENTIAL PRIVILEGED INFORMATION. IF YOU ARE NOT THE INTENDED RECIPIENT, YOU ARE PROHIBITED FROM READING, OPENING, PRINTING, COPYING, FORWARDING, OR SAVING THIS MAIL AND IT'S ATTACHMENTS. PLEASE DELETE THE MESSAGE AND ITS EMBEDDED FILES WITHOUT READING, OPENING, PRINTING, COPYING, FORWARDING, OR SAVING THEM, AND NOTIFY THE SENDER IMMEDIATELY AT 561.364.4240. IF YOU ARE THE INTENDED RECIPIENT, YOU ARE PROHIBITED FROM FORWARDING THEM OR OTHERWISE DISCLOSING THESE CONTENTS TO OTHERS, UNLESS EXPRESSLY DESIGNATED BY THE SENDER. THANK YOU!

I. Introduction

Iviewit and its affiliates did not fall into problems due to anything to do with dot.com companies nor market conditions and in fact this was a small part of Iviewit's anticipated revenues. Iviewit is a technology company with technologies believed to be worth billions of dollars. Iviewit has fallen into trouble from a host of criminal activities, including but not limited to attempted patent theft. Further attempts to cover up such crimes with frivolous and fraudulent lawsuits by our former attorney Mr. Wheeler and attempts to Bankrupt the Company by former management referred to the Company by Mr. Wheeler. These actions came on the heels of investigations into the criminal activities, which will become apparent as the Bar of Florida reviews the attached evidence and rebuttals from both P. Stephen Lamont and Eliot Bernstein. The lawsuits and bankruptcy actions are forms of harassment that have caused the Company, its shareholders, investors and employee's tremendous loss and put our Intellectual Properties at risk of being lost over a 20 year period.

We submit as evidence [Exhibit A](#), which is the Counter Claim filed by attorney Steven Selz, Esq. of the State of Florida. The Counter Claim, which is the basis of much of the Florida Bar complaint against Respondent, was completely ignored, as were rebuttals to the specific allegations contained therein. Although the Respondent hinges his response on allegations that Mr. Eliot Bernstein is somehow a conspiracy theorist, competent and licensed attorney Mr. Selz, with the help of yet another competent and licensed attorney Caroline Prochotska Rogers, Esq., filed the Counter Complaint after a thorough review of the parole evidence contained in part herein. We urge the Bar of Florida to read the Counter Complaint in its entirety as it was not rejected based on its merits in Judge Labarga's court, but simply because it took too long to get a response on file. Part of the reason was due to the amount of evidence Mr. Selz had to sift through to assess the full scope of the Conspiracy and partially because it took the Company many months to find documents that had been destroyed from the Company's records and computer files by Respondent and his management team. At yet the urging of another most competent attorney, Michele Mulrooney, Esq., the Company was urged to file complaints against all the legal perpetrators of such crimes with the State Bar Associations they belong to.

A brief overview of the events that have harmed the Company will help as you sift through the mountains of evidence contained herein. It was in 1998 that Iviewit, through



Lorraine Christine Hoffman, Esq.
Assistant Staff Counsel
The Florida Bar
File No. 2003-51, 109(15C)

its accountant, Gerald Lewin, referred Iviewit to Proskauer Rose and Mr. Albert Gortz, Kenneth Rubenstein, Raymond Joao and Christopher Wheeler, to protect and secure the technologies discovered by Eliot Bernstein, Zakirul Shirajee, Jude Rosario and Jeffrey Friedstein, by securing for the Company patents. After a thorough review by Mr. Rubenstein, Proskauer took on the role of securing patents for Iviewit, Mr. Rubenstein acting as both lead patent counsel and in an Advisory Board capacity, as well as, a shareholder through Proskauer Rose stock ownership of 2.5% in Iviewit. It is the Companies contention that Mr. Rubenstein was hired at this very moment in time by Proskauer Rose by Mr. Wheeler after learning of the value of the Iviewit technologies, Proskauer at that time did not have an Intellectual Property division for multimedia technologies for its 200-year history and suddenly it hired the entire Meltzer Lippe Goldstein and Schlissel patent department. Further, Rubenstein was brought in to Proskauer Rose to monetize the Iviewit processes, not to inure benefit to Proskauer and their clients but for Iviewit and their investors. Mr. Rubenstein as patent counsel to a number of major patent pools and their clientele has the Iviewit technologies currently being used on a number of products for hardware, software, DVD's, multimedia and chips and Iviewit has not received a dollar of license from companies using it and many of them under NDA's drafted and secured by Mr. Wheeler.

Mr. Wheeler brought into the Iviewit companies, patent teams, he brought in management, he brought his clients, he brought his investors, he was in meeting after meeting selling the technologies and he billed Iviewit approximately \$800,000 and he now tries to say under deposition that he hardly knows Iviewit and it's technologies. Mr. Rubenstein, his partner, under oath denies knowledge of the Companies in his deposition and when confronted with evidence of his involvement and billings with his name in them pleads a COI and other nonsense defenses and Judge Jorge Labarga has demanded him back to the deposition to answer the questions he refused in the first deposition, evidence will be produced throughout to advance these claims that Mr. Rubenstein has committed perjury in his deposition. It is interesting to note that when Mr. Rubenstein was summoned for deposition Proskauer Rose claimed that he had absolutely NOTHING to do with Company and had no knowledge and therefore should not be deposed, a review of the evidence contained herein will show far more involvement than NOTHING and an attempt to cover up his involvement, as any involvement on his part would spark massive Conflicts of Interests. Mr. Wheeler likewise under deposition and in statements to the Florida Bar has claimed that Proskauer Rose did NO patent work for Iviewit, and when confronted with the billings regarding meeting after meeting regarding the patents or licensing of the patents, denies recall of what and whom the billings are with and denies any further notes on such patent bill entries that he cannot recall. He cannot recall why he contacts Kenneth Rubenstein on numerous occasions and bills for such to Iviewit. Mr. Wheeler and Mr. Rubenstein both under deposition are unsure if a Conflicts Check was even run on Iviewit and Iviewit is unaware that any check was done nothing was ever presented to the Company regarding such.



Lorraine Christine Hoffman, Esq.
Assistant Staff Counsel
The Florida Bar
File No. 2003-51, 109(15C)

They take on representation of Iviewit for nearly a year with no retainer agreement in place and they hide billings from this period that still remain missing, even in their frivolous billing dispute. We submit to the Bar of Florida the following piece of evidence drafted by Mr. Wheeler himself and referring to patent counsel Kenneth Rubenstein.



Christopher C. Wheeler
Member of the Firm

Direct Dial 561.995.4702
cwheeler@proskauer.com

April 26, 1999

Mr. Richard Rossman
Lewinter and Rossman
16255 Ventura Blvd., Suite 600
Encino, CA 91436

Re: iviewit, Inc.

Dear Richard:

Under separate cover I have forwarded you a revised Confidentiality Agreement.

As you know we have undertaken representation of iviewit, Inc. ("iviewit") and are helping them coordinate their corporate and intellectual property matters. In that regard, we have reviewed their technology and procured patent counsel for them. We believe the iviewit technology is far superior to anything presently available with which we are familiar. Iviewit has filed a provisional patent application on a method for providing enhanced digital images on telecommunications networks. We are advised by patent counsel that the process appears novel and may be protected by the patent laws. While in all matters of this sort, it is far to early to make any final pronouncements, we do believe that there is an extremely good prospect that iviewit will protect their process which is novel and superior to any other format which we have seen.

Very truly yours,

Christopher C. Wheeler

CCW/gh



Lorraine Christine Hoffman, Esq.
 Assistant Staff Counsel
 The Florida Bar
 File No. 2003-51, 109(15C)

200

1 Company Certificate as Exhibit to opinion, et cetera,
 2 et cetera. There were more - I would imagine they
 3 were corporate matters. We wouldn't have opined - we
 4 never opined to the intellectual property.

Wheeler's deposition p.200:

20 Q. So you never made any representation to
 21 any party with regard to anything concerning the
 22 invention or the process or however we're going to
 23 describe this particular zoom and pan or enlargement
 24 without pixilation?

25 A. No, no. I mean, what would I have said?

KEN SCHANZER & ASSOCIATES, INC. (954) 922-2660

103

1 What you see is what you get. Look at - this is what
 2 we have, and this is what the company intends to do.

3 Q. Was there ever any representation made
 4 that you can recall that the technology, to the extent
 5 that it was going to be protected or was in a soon to
 6 be protected form, would be compensated by royalties
 7 almost immediately?

8 A. NO.

Wheeler's deposition p.102-103:

We submit an opinion from Mr. Wheeler with regards to a technology evaluation that was done by Real 3D for Mr. Wayne Huizenga. It was submitted to the head of the Investment Group for the Iviewit accountant, what is interesting to note is that Mr. Wheeler refers to the technology as "our" technology?



Lorraine Christine Hoffman, Esq.
Assistant Staff Counsel
The Florida Bar
File No. 2003-51, 109(15C)

JUL 23 1999 17:17 FR PROSKAUER ROSE

561 241 7145 TO 0894#40017001#41 P.03/09

PROSKAUER ROSE LLP

2255 Glades Road
Suite 340 West
Boca Raton, FL 33431-7360
Telephone 561.241.7400
Elsewhere in Florida
800.432.7746
Fax 561.241.7145

NEW YORK
LOS ANGELES
WASHINGTON
NEWARK
PARIS

Christopher C. Wheeler
Member of the Firm

Direct Dial 561.995.4702
cwheeler@proskauer.com

July 23, 1999

VIA FAX

Mr. Cris V. Branden
Huizenga Holdings, Inc.
450 East Las Olas Blvd., Suite 1500
Ft. Lauderdale, FL 33301

Dear Cris:

Per our discussion, enclosed please find Evaluation Feedback and proposed Confidential Term Sheet. Please note the last sentence of the Evaluation Feedback. We view this as a validation of our technology and an indication of Rea 3D's intent to move forward.

Best regards.

Cordially,

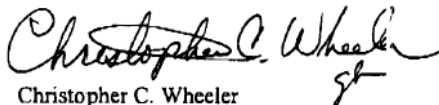
Christopher C. Wheeler

CCW/gb

0894/40017-001 BRUB1/236644 v1

07/23/99 04:53 PM (2743)

Once it was determined that the concepts were “novel” a term for patents to deem them new ideas, Mr. Wheeler took stock in the Company and assured the Company that Mr. Rubenstein as lead counsel of several leading patent pools (i.e. MPEG and DVD) would



Lorraine Christine Hoffman, Esq.
Assistant Staff Counsel
The Florida Bar
File No. 2003-51, 109(15C)

put the Iviewit concepts in such pools and the royalties would be paid to the Company in the millions annually, in addition to their clients payments for usage. Mr. Wheeler then took the technologies to another friend client, Mr. Ferguson the CEO of Boca Research, a client of his, who then referred us to Real 3D (a consortium of Intel, Silicon Graphics, Inc and Lockheed). A Board member of Boca Research, a Mr. Gerald Stanley was the CEO of Real3D and he was brought in to analyze the applications as one of the leading imaging experts in the world. After telling the Company that Mr. Rubenstein had secured patents, Mr. Stanley and then Real 3D signed NDA's drafted and negotiated by Mr. Wheeler, and Mr. Wheeler arranged for a meeting at Real 3D to disclose the patent processes to a team of technologists from Real 3D. The meeting took place after Mr. Stanley had come to Mr. Wheeler's office for a presentation and was astounded by what he saw, he could not believe his eyes and at Mr. Wheeler's urging the meeting at his offices was set up, approximately 10-15 engineers spanning every form of imaging, video, gaming and 3D applications were brought in by Mr. Stanley to review the technologies.

Several days before the meeting we had requested Mr. Wheeler and Rubenstein to procure the patents for review by the inventors and Respondent claimed that Mr. Rubenstein and his underling Mr. Joao, were holding them in the NY office of Proskauer Rose and they would be sent overnight mail. Well they never arrived and on the way to the meeting Mr. Wheeler assured the Company that they were on file for the three inventions; imaging, video and a combination of the two that had been disclosed to Mr. Rubenstein and Mr. Joao. With no patents we drove to Orlando for this meeting and both Joao and Rubenstein who were supposed to telephonically attend the meeting as patent counsel were missing. Any form of communication could not reach them and the Company grew alarmed as we pulled up to the meeting.

Mr. Wheeler assured us that he could represent our patents and act as "pseudo" patent counsel as he had been interfacing with Kenneth Rubenstein and Raymond Joao, but when the meeting started and the technologies were presented, Simon Bernstein – Chairman of the Board of Iviewit, was weary of releasing the patent processes without patent counsel or proof that patents for all the processes indeed existed. The Company refrained from disclosure of the video processes even though Mr. Wheeler begged the inventors to tell the processes assuring us that his NDA protected us and that it was a large waste of time that would make him embarrassed with his friends if we wasted their time. Simon Bernstein held fast in his decision and the meeting continued without certain disclosures. After viewing the processes with approximately 15 engineers, Mr. Stanley asked his lead technologist, Rosalie Bibona to opine on the value if the processes indeed were "novel" as Mr. Wheeler represented. What she and the other engineers said was that if "novel" the imaging process would be worth billions annually as it would apply to every known form of digital imaging and graphics. The video process they said



Lorraine Christine Hoffman, Esq.
Assistant Staff Counsel
The Florida Bar
File No. 2003-51, 109(15C)

was the “holy grail” of video and would be used in every form of video transmission and thus was “priceless”. The combination of the two processes they claimed would lead to an all-new field of video/imaging, again “priceless”. With this evaluation complete, we drove back and Mr. Wheeler claimed that his **best friend** Brian Utley would be a perfect fit for the Company to help secure the patents and work with Mr. Rubenstein and Mr. Joao and he told us he was one of IBM’s leading engineers and had developed the AS400 and the PC. He told us they sat on the Board of FAU together and that his last employer Mr. Monte Friedkin was also on the Board and was completely satisfied with Utley’s performance.

Iviewit and Real 3D entered into an agreement drafted by Wheeler that was leading to a more defined licensing agreement when Intel (a 10% minority owner) bought out Real 3D and it is the Company’s contention that as the Company was acquired the Company’s patent pending technologies got acquired with it and landed on the chip. Mr. Rubenstein has negotiated technology transfers with Intel and this is a conflict that was never disclosed when we engaged him, as with many of his clients there are major conflicts of interest that were never disclosed and will be evidenced throughout. It is imperative to note that if the Respondents defense that they did no patent work and Rubenstein does not know the Company are proven false, the Conflicts of Interest for the Respondent, Mr. Rubenstein and Proskauer Rose are overwhelming in number.

Upon return from this trip to Real 3D, the patent arrived at Mr. Bernstein’s home and it was quite a shock as only one patent was contained in the parcel for the imaging process. Grave concern was raised and Mr. Joao and Mr. Rubenstein were contacted and Mr. Joao said he was in the process of filing the video patent and would need to again receive disclosure of the ideas from the inventors. Mr. Rubenstein opined that there was no need to worry that patents were based on date of invention and not on date of filing. We learned much later that this was only true in the US and not in many foreign countries. What was also apparent was that the inventors were not all listed on the patent and Mr. Rubenstein, Mr. Joao and Respondent had told us earlier that until their immigration status was complete they could not be listed as inventors, and thus we hired Proskauer to get their status expedited. About this time at Mr. Bernstein’s home a series of break-ins occurred at which Mr. Wheeler suggested taking all patents, drafts and related documents to his office for safe keeping, which Mr. Bernstein complied with.

As will be evidenced in this rebuttal, we had in February 1999 prior to the Real 3D meeting found that Mr. Rubenstein and Mr. Joao were NOT listed at Proskauer Rose as Mr. Wheeler had represented, and when a search was done on Martindale they were found to be working at the firm of Meltzer Lippe Goldstein and Schlissel of Mineola NY and Rubenstein was also listed at a one Baer Marks & Upham. When confronted with this finding in February of 1999, Mr. Wheeler claimed that Rubenstein and Joao were in transition and that Mr. Rubenstein was almost a partner and Mr. Joao was following but



Lorraine Christine Hoffman, Esq.
Assistant Staff Counsel
The Florida Bar
File No. 2003-51, 109(15C)

had some loss ends at MLGS to finish up and asked if in the interim a retainer with that firm could be secured for Mr. Joao's work. What we did not know is that 5-6 partners of Meltzer Lippe's patent team had suddenly been hired by Proskauer Rose and that Mr. Joao was the only one left. We have recently found out that not even this is true as Joao states in his Bar Action response to the State of New York that he had transferred in 2/99 to Meltzer Lippe Goldstein and Schlissel. One need ask, why would Kenneth Rubenstein who had transitioned the entire patent department of Meltzer Lippe Goldstein and Schlissel to Proskauer Rose when confronted with a product that had significant value to almost everyone of his clients, refer the matter out to Meltzer who had no patent department left and had just almost to the day Rubenstein claims he referred us to Meltzer, had hired Raymond Joao. In light of his new position with Proskauer and his need to bill hours, Mr. Rubenstein instead of turning the patent filing work over to his other partners from Proskauer, mysteriously refers the matter out, to a man who now claims that Iviewit is infringing on his patents. The Company was dismayed at the request as it burdened us with two law firms and Proskauer had already taken stock in Iviewit and was waiving payment were MLGS wanted a @\$5,000 retainer for Mr. Joao's services. Mr. Wheeler assured the Company that it would be a very short time until Proskauer would employ Mr. Joao, so the Company complied.

Mr. Wheeler then circulated a resume for Mr. Utley to Eliot Bernstein who circulated it to other members of the Company, the Board and investors, for review. The resume, as will be evidenced in this rebuttal, contained many false statements and when we researched Mr. Utley's background with his prior employer, after it was found that he was stealing patents from the Company, we were shocked at the gross misrepresentations that were uncovered as we are sure the Florida Bar will be, whereby at his last employer he was fired over patent disputes. Mr. Wheeler (as evidenced in Mr. Utley's own deposition) had full knowledge of this past patent problem with his former employer Monte Friedkin whom Mr. Wheeler knows personally as well. Nonetheless, without hindsight and trusting Mr. Wheeler's representation of Mr. Utley, we hired Mr. Utley who began working with Mr. Joao, Mr. Rubenstein and the Respondent to secure patents for the Company.

Wayne Huizenga and his son Wayne Huizenga Jr. were excited at the news from Mr. Rubenstein, and Real 3D, and Mr. Wheeler who had referred them, attended many of the meetings where the technologies were displayed which led to the initial investment by Mr. Huizenga. Mr. Wheeler at those meetings was constantly assuring the Huzienga investment team that the patents were in place and being handled by the esteemed Mr. Rubenstein. Mr. Huizenga based on Mr. Wheeler's representations then invested the seed \$500,000. The Company appeared to be on its way to a billion dollar venture.



Lorraine Christine Hoffman, Esq.
Assistant Staff Counsel
The Florida Bar
File No. 2003-51, 109(15C)

09/10/99 C WHEELER 2.00 Conf with Mr. Brandon; conf with Mr. Brandon;
conf with Mr. Rubenstein; transmittal of
materials to Mr. Rubenstein; Call to Mr. Joao

Several months after the initial investment, Mr. Utley and Mr. Wheeler came to the Board and suggested starting a service business that would process images and videos for customers. This had been an early idea of the Companies that was rejected once it was determined that we would be a technology license Company and thus we had designed the Company to be suited for such patent license models as was suggested by several Board members who had backgrounds in technology companies. Mr. Wheeler assured the Company that with his clientele from Proskauer Rose and Mr. Utley's contacts from IBM, they would have customers to fill encoding service labs worldwide. That while we waited for the patents to get approved that we were missing a major opportunity and that he would be able to secure additional funds from Mr. Huizenga's group. He said the cost to setting up some companies would be nominal and that it would pose no risks.

We submit the following evidence for review:



Lorraine Christine Hoffman, Esq.
Assistant Staff Counsel
The Florida Bar
File No. 2003-51, 109(15C)

-----Original Message-----

From: James F. Armstrong [mailto:jarmstrong1@home.com]
Sent: Saturday, July 22, 2000 11:08 AM
To: Christopher C. Wheeler (E-mail)
Subject: iviewit
Importance: High

Dear Chris,

I will be back in Boca on Tuesday, Wednesday and Thursday of next week (7/25-7/27). As we discussed, I have prepared a draft of the letter that you agreed to send to your partners, a one page flyer describing our services, and prepared copies of the CD-Rom for your distribution. Finally, I've also reviewed your client list and made note of some of the most promising relationships.

Are you available for a brief meeting on Wednesday to review these items and to establish goals for this initiative? If Wednesday is not convenient, I do have available time on both Tuesday and Thursday. Please call me on Monday or respond via email.

Thanks for your help!
Sincerely,

-Jim

James F. Armstrong
VP Sales & Marketing
iviewit.com, LLC.
Cell: 561-866-2042
Email: jim@iviewit.com

Northeast Offices

126 Buttonwood Drive
Fair Haven, NJ. 07704
Voice: 732-747-1448
Fax: 732-747-5569

Home Office

One Boca Place
2255 Glades Road
Suite 337 West
Boca Raton, FL. 33431
Voice: 877-484-8444
Fax: 561-999-8810

Incoming mail is certified Virus Free.
Checked by AVG anti-virus system (<http://www.grisoft.com>).
Version: 6.0.459 / Virus Database: 258 - Release Date: 2/25/2003



Lorraine Christine Hoffman, Esq.
Assistant Staff Counsel
The Florida Bar
File No. 2003-51, 109(15C)

Dear Colleagues,

As a firm, we are in a unique position to impact the effectiveness of the Internet and to profit from the same. The firm of iviewit.com, Inc. is one of my clients and Proskauer, Rose, LLP. is a 2.5% shareholder. I have worked closely with iviewit, for the past 18 months, establishing and fine-tuning their corporate structure. My objective with this letter is to introduce you to this forward-thinking company and to ask for your support and assistance.

The Internet is quickly evolving from a text-based medium that users have been forced to read, into a multimedia platform that users can begin to *experience*. The importance that this evolution has to e-commerce has been likened to the impact felt by television when it was embraced as a marketing and communications tool. iviewit's intellectual property positions them as a leader in the streaming video, streaming audio and virtual imaging online markets. Their technologies have broad ranging applications for many different industries including: entertainment, auctions, education, healthcare and retail.

Because of the extensive applicability of iviewit's products, the vast majority of Proskauer's client relationships represent potential clients for iviewit. Please join me as I endeavor to introduce my clients to iviewit and, in the process, help those clients to gain a competitive advantage through the utilization of iviewit's technologies. Please contact me with any opportunities that you identify and I will arrange an introduction to a member of iviewit's management team. I have enclosed a descriptive flyer from iviewit and a multimedia CD-ROM that will serve as an introduction to iviewit. Additional information can be found at their website, www.iviewit.com.

Thank you for your time and attention. I look forward to working together to help this valued client and to further enhance the value of our equity position in iviewit.

Sincerely,

Christopher C. Wheeler

Outgoing mail is certified Virus Free.
Checked by AVG anti-virus system (<http://www.grisoft.com>).
Version: 6.0.459 / Virus Database: 258 - Release Date: 2/25/2003

It is interesting to note that not a single client of Proskauer Rose or Brian Utley even though many were under NDA's secured by Wheeler, have ever paid Iviewit, although many of them now utilize many of Iviewit's processes.

Mr. Wheeler began setting up the Companies for the operations and then came to the Board members stating that Mr. Huizenga would not make further investment unless the inventors assigned the patents to a Company. This statement concerned the Board



Lorraine Christine Hoffman, Esq.
Assistant Staff Counsel
The Florida Bar
File No. 2003-51, 109(15C)

members and everyone was concerned that this would put the patents at risk in the event of a Bankruptcy or a lawsuit and Mr. Wheeler assured the Board and several consultants brought in to analyze his structure that he had developed a plan that would protect the patents in any of these circumstances, as he would set up a holding company to hold the patents and several operational companies to handle the encoding. This plan of his was to cost the Company very little to set-up, (refer to the Proskauer bills to see the enormous cost and complexities) as several people took issue with the rationale of setting up so many Companies. It was resolved that upon Mr. Wheeler's advice, although we will later submit evidence that his own Proskauer Rose partner had advised him to have the inventors license the Company, that this structure was implemented. It is of interest to note that Mr. Wheeler is the first person trying to sue the Company that holds the patents in the Proskauer lawsuit he references in his response to the Bar and gain access to the Intellectual Property he was hired to protect, even though he has no bills evidenced with the Company that holds the patents, Iviewit Holdings, Inc.

Once his structure was set up, he went to Mr. Huizenga for more investment, whereby Mr. Huizenga wanted a review of the patents. Mr. Stephen Filipek, Esq. contacted Mr. Wheeler whereby a meeting was set up at the offices of Proskauer Rose in New York with Mr. Utley, Mr. Rubenstein, and Mr. Joao to review the patents. Upon his return, Mr. Cris Brandon of Huizenga Holdings contacted Mr. Bernstein and informed him that Mr. Filipek's review came back negative and that he was very concerned that the patents in no way covered the inventions we had invented and he had invested in. Mr. Wheeler was summoned and he contacted Kenneth Rubenstein and Mr. Joao who assured him that Mr. Filipek did not understand the patents on his first read and that everything was all right and could be explained. A meeting was set up with Huizenga and Mr. Wheeler, Mr. Utley and Simon Bernstein went to the Huizenga group and were sent back with a no to further investment. Mr. Wheeler then contacted Mr. Eliot Bernstein with Mr. Utley claiming that the reason for Mr. Huizenga not investing was due to his fathers attack of one of the Huizenga principles and nothing to do with the patents, and they urged Mr. E. Bernstein that if he did not fire his father immediately from the Board that Huizenga would not participate. Eliot refused such request and wanted further investigation into the patent problems.

It was at this point in time that through another Wheeler referral, Maurice Buchsbaum, later Board Member and Employee of Iviewit that another friend of Mr. Wheelers was brought in to invest in the Company, Stephen Warner of Crossbow Ventures. Mr. Buchsbaum was also an advisor to the Crossbow fund with his offices in their West Palm office and Mr. Wheeler assured the Company that they would do a thorough patent review with Mr. Rubenstein and Mr. Joao before investing in the Company. In short order, after seeing the technology only once and relying on statements made by Mr. Wheeler who attended and led the meetings, they committed to an investment in the Company. Mr. Wheeler, Mr. Buchsbaum and Mr. Utley assured the Company that the



Lorraine Christine Hoffman, Esq.
Assistant Staff Counsel
The Florida Bar
File No. 2003-51, 109(15C)

patents were being analyzed by Crossbow Ventures patent counsel as part of their due diligence and as standard fiduciary responsibilities to their investors, with Rubenstein/Joao. Mr. Wheeler opined that the review was concluded and that the patents were fine and an investment was then secured by Crossbow Ventures. Mr. Wheeler handled this series of transactions for the Company.

Mr. Eliot Bernstein and several board members were not content with a simple verbal assurance and wanted to review the patents and what was found was that like Mr. Filipek, the substance of the patents seemed altered and in fact, the patents were altered by Mr. Joao, which will be evidenced later in the rebuttal as true, before being filed with the patent office, which constitutes not only fraud against Iviewit but fraud against the US Patent office. Mr. Bernstein demanded explanations to this phenomenon and what followed is even more bizarre. Upon reviewing the patents, it was determined that they were all filed at different times then was represented, that they were all still missing inventors (which when Mr. Bernstein researched Mr. Rubenstein's claim that foreigners could not be listed, he found evidence to the contrary) and that the content had been changed from what he and the inventors had disclosed and signed patents for. Even after Mr. Rubenstein/Joao were confronted with the fallacy of their statement that foreigners could not be listed as inventors, they still failed to properly amend the patents, although they had the inventors Shirajee and Rosario sign such invention forms. As will be evidenced, Mr. Utley upon questioning suddenly re-reviews the patents he had been working on with Mr. Joao and writes Raymond Joao a letter stating that there were major missing items in the patents and suggests with Mr. Wheeler that a friend of theirs, Mr. William Dick of Foley and Lardner be brought in to analyze and correct the work of Mr. Joao/Rubenstein.

Mr. Wheeler and Mr. Utley make representation that the work of Joao is inadequate as will be evidenced in the rebuttal in taped conversations, and that Mr. Dick and Foley and Lardner can correct the errors. Mr. Dick is NOT represented as having been the attorney who was involved in past patent malfeasances with Mr. Utley at his former employer by either Mr. Wheeler or Mr. Utley, the Company would not learn this until Mr. Utley's deposition in the Proskauer vs. Iviewit case. With imminent patent filing dates looming the Company retains Foley and Lardner to begin correcting Mr. Joao and Mr. Rubenstein's faulty filings and undertake a series of disclosures with all the inventors to new patent attorney's put in place by Mr. Dick from Foley and Lardner. Foley's analysis was that the problems could be rectified and that therefore Mr. Wheeler opined that there would be no need to pursue Raymond Joao on charges, as evidenced in the taped conversations, which will later be exhibited.

After several months of work, Mr. Utley confronts Mr. Eliot Bernstein with a set of blank signature pages to sign for the new patents. Mr. Bernstein accompanied by Mr. James Armstrong refuses to sign blank pages at which time Mr. Utley begins to get upset and



Lorraine Christine Hoffman, Esq.
Assistant Staff Counsel
The Florida Bar
File No. 2003-51, 109(15C)

points to several large 3 ring binders and claims that there is no time for Mr. Bernstein to review as they have to be filed by midnight. Mr. Bernstein refuses further and Mr. Utley demands signatures and refuses to turn over the patent binders to Mr. Bernstein. Mr. Bernstein advises Mr. Armstrong that he is going to take the binders from Mr. Utley and if Mr. Utley tries to stop him, to restrain him until the police can be contacted. Mr. Bernstein then grabs the patent binders from Utley and Mr. Armstrong notifies Mr. Utley to stand down or else we would contact the police at which point Mr. Bernstein has his secretary, Jennifer Kluge photocopy the binders. Mr. Armstrong and Mr. Bernstein then leave the office to review such patents. Mr. Bernstein contacts Foley and Lardner where he finds that patents are not due until the following day at midnight. Mr. Armstrong and Mr. Bernstein begin an all night review of the patents and what they find is astonishing. First, they find the patents fraught with mathematical errors. Second, that the inventors have been switched and changed from what was told to Foley and Lardner and that Mr. Utley has replaced inventors with himself. Third, that the patent content and titles had been changed from what was disclosed to the Foley and Lardner team. We did not however, without hindsight, know that the reasons for these errors was due to other patents being written into Mr. Utley's home address with the correct formulas, with Utley listed as sole inventor, not assigned to the Company with Foley and Lardner having procured such fraudulent documents, so the errors seemed to be mistakes at the time.

Mr. Utley, Mary Viadero and Martha Manteconn, (Mary and Martha former employees of Mr. Utley's at Diamond Turf Lawnmower where they were all fired for past patent malfeasances) began a massive shredding of documents at this point.

Upon this discovery of massive mistakes by Foley and Lardner, Mr. Bernstein and Mr. Armstrong went to Simon Bernstein and Maurice Buchsbaum two Board members with evidence of the wrongdoings. It was determined that taped meetings should be held with representatives of Foley and Lardner, Christopher Wheeler of Proskauer Rose, Mr. Utley, Eliot and Simon Mr. Bernstein and Mr. Armstrong to confront the problems and allegations. Copies of these transcripts will be attached as exhibits to this rebuttal from meetings held 7/31/00 [Exhibit E](#), 8/2/00 [Exhibit F](#) and 8/4/00 [Exhibit G](#). After listening to these attorney's excuses for these errors, it was requested that Foley and Lardner execute a letter stating the liabilities that they may have caused so that the Board and Investors could be notified of such potential damages. At this point it is clear that despite deposition statement to the contrary from both Mr. Utley and Mr. Wheeler, they were fully cognizant of such errors from both the Joao/Rubenstein filings and the Foley and Lardner filings.

Investigations began around this point in time by Mr. Bernstein into the entire state of affairs that Mr. Wheeler and his cohorts had put the Company in. Of course this was going to take time and Mr. Bernstein was involved in major licensing deals in California. Mr. Bernstein at this time was also notified by Maurice Buchsbaum that further patent



Lorraine Christine Hoffman, Esq.
Assistant Staff Counsel
The Florida Bar
File No. 2003-51, 109(15C)

malfeasance may have been occurring by Mr. Utley and Mr. Dick and that several patents not in the Company's possession may have been illegally been transferred into Mr. Utley's home address, without assignment to the Company, with Mr. Utley listing himself as the sole inventor, with Foley and Lardner representatives aiding and abetting this crime. This crime would not only be against Iviewit if true, but a direct fraud on the US Patent Office.

We submit as evidence and will further expand on this document throughout the rebuttal the following patent applied for by Mr. Utley which is for the core imaging technology mathematics, that he claims he invented, sent to his home address and that he further failed to assign to the Company, although his sworn deposition testimony is that no patents were in his sole name and no patents were not assigned to Iviewit.



Lorraine Christine Hoffman, Esq.
Assistant Staff Counsel
The Florida Bar
File No. 2003-51, 109(15C)

Atty. Dis. No. 57103/123

U.S. PROVISIONAL PATENT APPLICATION

for

**ZOOM AND PAN IMAGING
DESIGN TOOL**

Inventors:



Brian G. Utley
1930 SW 8th Street
Boca Raton, FLORIDA 33486
Citizenship: U.S.



FOLEY & LARDNER
Attorneys at Law
777 E. Wisconsin Avenue
Milwaukee, Wisconsin 53202
(414) 271-2400



Lorraine Christine Hoffman, Esq.
 Assistant Staff Counsel
 The Florida Bar
 File No. 2003-51, 109(15C)

VIEWIT.COM PATENT STATUS REPORT

05707

TITLE	MATTER	INVENTOR/ PATENTEE	COUNTRY	SERIAL NO./ PATENT NO.	FILED/ISSUE DATE	ASSIGNEE
<u>Zoom and Pan Imaging Using a Digital Camera</u>	P020 (fka 122)	<u>Brian Utley</u>	United States	Serial No. 60/223,344	Filed 09/18/00	<u>Not assigned.</u>
<u>Zoom and Pan Imaging Design Tool</u>	P021 (fka 123)	<u>Brian Utley</u>	United States	Serial No. 60/233,341	Filed 09/18/00	<u>Not assigned.</u>

Blakely, Sokoloff, Taylor & Zafman

In another instance to be evidenced later, is another application procured the same way for Zoom and Pan on a Digital Camera in which Utley claims sole inventorship for and is for a technology that now exists on almost all digital cameras known commonly now as “Digital Zoom”.

Further Respondent and his partners interfered with client Warner Bros. and AOLTW that led to the end of several prominent accounts and a potential 20M investment, as will be evidenced. It should be understood that the Company was mainly run and operated by Mr. Wheeler, his hand picked patent attorneys (Raymond Joao, Kenneth Rubenstein, William Dick), his hand picked management team (Brian Utley, Maurice Buchsbaum, Raymond Hersh and Michael Reale), his investment referrals (Crossbow Ventures and Tiedemann/Prolow Group) and his client referrals. Mr. Wheeler in his deposition and his statements to the Bar of Florida feigns that he hardly knew the technology and many other ridiculous statements, considering the number of meetings he oversaw, business plans he controlled and distributed and opinions and technical evaluations he preformed and billed for. Iviewit’s technologies were a part of his everyday life as you will see from the volumes of billings submitted and yet he acts as if he has forgotten what the Company was all about. Mr. Wheeler was running and controlling the Company in all facets of its operations and Intellectual Properties, the evidence is overwhelming. The only regret the Company, its shareholders and investors have, is that we placed our trust in him. It is utterly disgusting that he now tries to say that his firm was not involved in the patents, it clearly emphasizes his greed and desire to steal such technologies from those that entrusted him. The perjured statements throughout his own deposition are testimony that he is willing to do anything to steal these technologies he was entrusted to protect.

One must ask oneself while reading through the evidence, why if Mr. Wheeler has referred all this competent help to procure and secure patents for Iviewit, why the patents are in a state that few that have reviewed them can say anything but they are fraught with



Lorraine Christine Hoffman, Esq.
Assistant Staff Counsel
The Florida Bar
File No. 2003-51, 109(15C)

problems. Mr. Wheeler consistently lambastes Mr. Bernstein as being a conspiracy theorist, when it takes just a matter of sifting through the evidence and asking the simple question of how with this much control over the Company, can the Company and its assets be in such a state of disarray? Why are documents missing? Why are patents not covering their scope and missing? Why are patent attorneys making mistakes in math? Why are patent attorneys writing patents into managements name without assignment or knowledge of the Company? Why are patent attorneys central to Company's technologies and advisors of the Company now denying that they have ever heard the name of the Company when the billings are replete with references of their name? Why have securities been transacted without Board approval or documents? Why are management members stealing highly proprietary equipment with patent processes to investors who are also Board members in violation of all fiduciary responsibilities? Why under deposition do we find many instances of perjury by management and the attorneys involved? Why are key billings missing from the lawyers that provided the services? Why have fraudulent patent documents been submitted to the US Patent office? Why are Copyrights billed for by attorneys completely missing and never filed? Why are the Companies technologies now in use in the following applications (DVD's, Digital Cameras, Computer Chips, Medical Imaging, Graphics Software, Set Top Boxes and hosts of other items) with no royalty payments to the Company? Why did Proskauer Rose run out and hire a patent department replete with someone to head it that is an expert in the exact science Iviewit's patents cover? Why does one of the Company's patent attorneys have 50+ patents in his own name since meeting the Company? This and much more can and will be answered throughout this rebuttal in one simple name, Christopher Clark Wheeler.

It was these malfeasances when uncovered that led to Iviewit's lead investor pulling funding on the Company and causing the Company massive damages. It is these actions all coordinated by Mr. Wheeler that are putting the patented technology at severe risk with the Patent Offices worldwide and stand to cost the Iviewit investors billions of dollars in revenues on applications already in use, as well as, the IRS tax revenue on such license fees. These allegations are not fly by night allegations but have many witnesses to the malfeasances and have been reviewed by many prominent law firms and lawyers, which have resulted in the filing of a Criminal Conspiracy charge that was submitted by the Company's attorney Steven Selz, Esq. against Proskauer. The complaint was submitted to the Bar with the Proskauer rebuttal and herein as [Exhibit A](#). It is interesting to note that although submitted by Proskauer as some form of evidence they clearly do not deal with one single aspect of the complaint. The allegations are not the result of Mr. Bernstein's conspiracy theory as the Respondent's reply to the Bar would have it, but are the culmination of a thorough and exhaustive two year review of the documents and evidence that follows. Mr. Bernstein did not draft the charges of the Civil Conspiracy; a competent and certified lawyer of the Florida Bar, Mr. Steven Selz, Esq. did this with input from a variety of other lawyers including Caroline Prochotska Rogers, Esq. and the



Lorraine Christine Hoffman, Esq.
Assistant Staff Counsel
The Florida Bar
File No. 2003-51, 109(15C)

CEO of Iviewit, P. Stephen Lamont whom is also a graduate of Columbia Law. Mr. Bernstein was a Founding Inventor, Board Member and Secretary for the Companies, whom has facilitated the evidence from the Company to competent, registered attorneys for analysis and it was their filing of the Counter Claim that alleges Civil Conspiracy. The witnesses to refute the Respondents claims are numerous and come from mainly legal, finance and accounting professions from the most respectable firms of these professions, we urge the Florida Bar to contact these most respected individuals whom have been submitted prior as witnesses.

We will now present the evidence to these allegations and are sure the Florida Bar will find that Mr. Wheeler has conspired in several instances to steal the Companies technologies and continues to cause harm to the Companies and its shareholders. In particular and as you will note throughout their depositions and Bar responses, it is apparent that their main form of defense is in hurting Mr. Bernstein, the main inventor, destroying his life (which they have successfully achieved) and stealing from him and others the inventions and their royalties. The only other defense is that while reviewing these documents and the actions that you will forget that this is real as it will appear as a scene from Pulp Fiction but remember that peoples lives are being destroyed over this, that a Company and its employees have all been hurt and finally shareholders and investors monies have been absconded with.



Lorraine Christine Hoffman, Esq.
Assistant Staff Counsel
The Florida Bar
File No. 2003-51, 109(15C)

II. Malfeasances in the transfer of Iviewit securities handled by Mr. Wheeler through Proskauer Rose, to a referral of Mr. Wheeler's, with no Board or investor approval which leads to the end of the Proskauer/Iviewit relationship. Mr. Wheeler's hand picked management team of Utley, Reale and Hersh are also terminated for same.

The Company will start with the point in time that malfeasances of Mr. Wheeler's came into light. Mr. Wheeler and Mr. Utley were caught transferring securities and attempting to transfer the patent assets to a friend of Mr. Wheeler's, a one Tiedemann/Prolow, and it is here that Proskauer began to take actions to harm the Company and a cover-up began. We submit as evidence from Donald Kane who at the time he joined Iviewit as a Board Member was a managing partner at Goldman Sachs, responsible for the technology sector. Mr. Kane sent the following email message regarding the illegal transfer of securities between Iviewit and a referred friend of Mr. Wheeler's Tiedemann/Prolow, that did not have any documentation signed for the transfer of the funds nor was ever presented to the Board. The concern amongst Board members of such decision without consulting either the Board and the Investors, is what ultimately led to the Company's current troubles with Proskauer. This transfer led to the entire Board of Directors to later resign, fearing repercussions from the potential liabilities from this transfer and other liabilities caused by Mr. Utley and his hand picked management team. Mr. Utley was fired with the rest of the Wheeler/Utley management team and the Company truly suffered, as Mr. Wheeler never appeared at another Board meeting, although requested by several members to explain his actions in these malfeasances from the period of 2/2001 through 4/2001.

As the Wheeler/Utley management team was fired, it is three employees direct testimony that management came in with a briefcase of cash, they said was from an investor, tried to bribe such employees to give them patent processes, trade secrets and steal corporate proprietary computers which contained the "patents secret sauce" and then proceeded to steal such machines and take them to a company partially owned by Mr. Prolow, who was acting as an Iviewit Board member at the time, which also is conflict with his fiduciary responsibilities to the Company.

We submit to the Bar the following evidence from Mr. Donald Kane a Board member at the time this was written. He refers to Mr. H. Hickman Powell of Crossbow Ventures an approximately 4 million dollar investor in the Company also being concerned, and asks Mr. Bernstein to speak with Alan Epstein, Esq. of the most respectable law firm of Armstrong Hirsh Jackoway Tyerman and Wertheimer in Los Angeles, regarding the potential implications of such illegal and improper transfer of such securities.



Lorraine Christine Hoffman, Esq.
Assistant Staff Counsel
The Florida Bar
File No. 2003-51, 109(15C)

-----Original Message-----

From: Donald Kane [mailto:dg_kane@msn.com]
Sent: Sunday, March 18, 2001 6:39 AM
To: Eliot I. Bernstein
Subject: RE: Board meeting on the 3rd

Elliot,

I spoke to Hank yesterday and will do so again today. The company is in a difficult position and the common shareholders risk losing the company to the preferred investors. Here are my thoughts:

2. The company has supposedly accepted money from a new investor group without proper documentation/approval on the terms and conditions with Hank or the board. You need to talk to Alan Epstein about this process. I am very uncomfortable with what I am hearing about management.

And we submit from Wheeler's deposition the following statements that deny that Mr. Kane is referring to a transaction handled by Mr. Wheeler to his friend and his referral Mr. Bruce Prolow and the investment firm of Tiedemann/Prolow. From the point of this email forward, Mr. Wheeler made no contact with the Company and failed to appear at the remaining Board meetings to explain his actions and instead has gone on a course of suing the Company to cover-up these actions:



Lorraine Christine Hoffman, Esq.
Assistant Staff Counsel
The Florida Bar
File No. 2003-51, 109(15C)

207

1 business plan that was produced or that you were
2 involved with, did it contain representations
3 concerning intellectual properties?

4 A. We weren't intimately involved in the
5 business plan, so I really don't recall the latest
6 reiteration. No.

7 Q. Do you know if Ken Rubenstein was ever
8 listed as an advisor to the board of directors or an
9 advisor to iviewit in any documents?

10 MR. TRIGGS: Object to the form. By whom?

11 Q. (By Mr. Selz) Do you know if Ken
12 Rubenstein was listed --

13 A. In any documents?

14 Q. -- by iviewit or - in any documents that
15 were submitted to any third parties as an advisor or
16 was represented as an advisor to the board?

17 A. Not - not that I'm aware of.

18 Q. What was the last business plan for
19 iviewit that you can recall seeing?

20 A. Well, I don't recall. I don't -- I
21 actually don't recall the last business plan. I mean,
22 the reason is, everything kept on changing so much.

23 Q. Was there ever any problem with
24 erroneously issued stock or anything of that nature
25 that you're familiar with?

KEN SCHANZER & ASSOCIATES, INC. (954) 922-2660



Lorraine Christine Hoffman, Esq.
Assistant Staff Counsel
The Florida Bar
File No. 2003-51, 109(15C)

208

1 A. I don't - I have no recollection of it.

p.207-208 Wheeler Deposition

17 shareholders themselves. And I don't know what the
18 final Prolow money was. I think the final Prolow
19 money was perhaps 200 to \$500,000 or something else.
20 Q. Well, I don't mean we've addressed Prolow
21 yet, so --
22 A. Well, you did ask me the question.
23 Q. Yeah. I did. You're right. So you don't
24 really have a total that you figured between these
25 amounts?
KEN SCHANZER & ASSOCIATES, INC. (954) 922-2660

94

1 A. No, I didn't focus on it.

p.93-94 Deposition Christopher Wheeler

And further from his deposition



Lorraine Christine Hoffman, Esq.
Assistant Staff Counsel
The Florida Bar
File No. 2003-51, 109(15C)

95

1 Q. Okay.

2 A. And I'm not so sure everyone participated,
3 but to a great extent, many did.

4 Q. Now, Bruce Prolow was another individual
5 who you indicated - Prolow, rather, was an individual
6 you indicated also invested?

7 A. Well, he had a group. I mean, he was a
8 person introduced to the company, but he - he -- I
9 don't know how his money came in. I don't know how it
10 was -- Don't know if it came in from one or two
11 investors or whatever.

12 MR. TRIGGS: Just do this. If this will
13 speed us up, the question was asked I think is
14 something about whether Bruce Prolow put money
15 in. Just - he wants you to answer the question
16 that he's asking, and it will speed us up if you
17 just answer the question he's asking.

18 A. I don't know.

19 Q. Okay. Do you know how much money came in
20 from Mr. Prolow?

21 A. No.

22 Q. Were you involved in preparing the
23 transactional documents with regard to any funding
24 that Mr. Prolow provided to Iviewit?

25 A. I can't remember.

KEN SCHANZER & ASSOCIATES, INC. (954) 922-2660

Now the Company will submit evidence that Mr. Wheeler was fully aware of the Tiedemann/Prolow investment and further that he had without Board approval drafted documentation regarding a proposed merger/acquisition regarding a Tiedemann/Prolow Company with Iviewit. These are the billings from Proskauer regarding these transactions and all overseen by Mr. Wheeler over a several month period and only represent a sample of the total billings for these transactions.



Lorraine Christine Hoffman, Esq.
Assistant Staff Counsel
The Florida Bar
File No. 2003-51, 109(15C)

09/14/00 C WHEELER	.75	Arrange for presentation to Mr. Prolow
09/22/00 C WHEELER	1.00	Arrange for follow up with potential investor Applestein
09/25/00 C WHEELER	.50	Follow up on prospective investors
09/26/00 C WHEELER	1.50	Attend Board meeting; follow up on question of recapitalization; arrange for transmittal to new investors
09/27/00 C WHEELER	1.50	Conf with Mr. Assaf; conf with Mr. Bernstein; Conf with Mr. Prolow; conf with Mr. Utley
09/28/00 C WHEELER	1.00	Call to Mr. Prolow; conf with Mr. Utley
09/28/00 C WHEELER	.50	Conf with Mr. Prolow
09/28/00 C WHEELER	.25	Arrange conf call as to financing
09/29/00 C WHEELER	2.50	Conf with Mr. Prolow and Mr. Utley; conf. with Prolow, Utley, Hersch, Buschbaum, et al re technology;
09/29/00 C WHEELER	.25	Call from Mr. Prolow
09/29/00 C WHEELER	.50	Meeting with Mr. Utley; review of status of potential investment
10/02/00 C WHEELER	.50	Follow up on conference call; call to Mr. Prolow
10/03/00 C WHEELER	1.00	Conf with Mr. Utley; conf with Mr. Utley; call to Mr. Prolow
10/03/00 C WHEELER	2.00	Conf call with Mr. Applestein, Mr. Prolow, Mr. Utley, Mr. Hersch, et. al.; conf with Mr. Hersch
10/03/00 C WHEELER	.50	Conf with auditors
10/03/00 C WHEELER	.25	Set up conf with investors
10/11/00 C WHEELER	.50	Conf with Mr. Prolow
10/12/00 C WHEELER	.50	Conf with Mr. Utley
10/12/00 C WHEELER	.25	Conf with Mr. Utley
10/13/00 C WHEELER	.50	Conf with Mr. Utley re investors and confidentiality agreement



Lorraine Christine Hoffman, Esq.
Assistant Staff Counsel
The Florida Bar
File No. 2003-51, 109(15C)

10/19/00 C WHEELER	1.25	Conf with Mr. Prolow re offer; conf with Mr. Utley; conf with Mr. Utley; conf with Mr. Prolow
10/23/00 C WHEELER	.50	Conf with Mr. Prolow re proposed investor
10/23/00 C WHEELER	.50	Conference w/B.Utley
10/26/00 C WHEELER	1.00	Conf with Mr. Prolow; conf with Mr. Utley; conf with Mr. Reed re trademark and copyright matters
10/31/00 C WHEELER	.50	Conf with Mr. Utley; conf with Mr. Rubenstein; Conf with Mr. Utley re financing
11/01/00 C WHEELER	.25	Conf with Mr. Utley re financing and re Mr. Rubenstein
11/03/00 C WHEELER	.50	Call to Mr. Utley; conf with Mr. Utley re funding;
11/03/00 C WHEELER	.50	Review of stock grant requests
11/05/00 C WHEELER	1.00	Conf with Mr. Utley; conf with Mr. Prolow re investors
11/06/00 C WHEELER	.50	Conf with Mr. Utley re investors
11/07/00 C WHEELER	.75	Conf with Mr. Utley re financing; call to Mr. Assaf; conf with Mr. Utley re Mr. Rubenstein
11/08/00 J ZAMMAS	.50	Preparation of receipt for iviewit minute books to be loaned to company; compile minute books for pickup.
11/09/00 C WHEELER	.75	Conf with Mr. Utley re funding ; conf with Mr. Assaf re funds; call to Mr. Prolow
11/09/00 C WHEELER	.50	Conf with Mr. Prolow; conf with Mr. Utley
11/10/00 D THOMPSON II	.50	Telephone conference with Attorney C. Wheeler re bridge financing; Follow-up re same.
11/10/00 C WHEELER	.50	Conf with Mr. Utley re financing
11/21/00 C WHEELER	.25	Call from Mr. Prolow
11/22/00 C WHEELER	.25	Call to Mr. Prolow
11/28/00 C WHEELER	.50	Conf with Mr. Utley re financing
12/01/00 C WHEELER	.50	Conf with Mr. Hersh; arrange transmittal of business plan to prospective investors



Lorraine Christine Hoffman, Esq.
Assistant Staff Counsel
The Florida Bar
File No. 2003-51, 109(15C)

12/01/00 C WHEELER	.25	Review of correspondence and documents
12/01/00 C WHEELER	.50	Additional review of documents and correspondence
12/08/00 C WHEELER	.25	Conf as to opinion and bridge loan
12/15/00 C WHEELER	.25	Conf with Mr. Prolow re financing
12/19/00 C WHEELER	.25	Call to Mr. Prolow
12/21/00 C WHEELER	.50	Conf with Mr. Utley
12/22/00 C WHEELER	.25	Conf with Mr. Utley
12/29/00 C WHEELER	.50	Conf with Mr. Prolow re financing
01/05/01 C WHEELER	.50	Conf with Mr. Prolow re status of new financing
01/09/01 D THOMPSON II	.25	Conference with Attorney Mara Lerner Robbins re offering.
01/10/01 C WHEELER	1.00	Follow up on term sheet for Tiedemann investment
01/11/01 C WHEELER	.50	Conf with Mr. Hersh; arrange for follow up on investment by Prolow
01/11/01 M ROBBINS	1.75	Inter-office conference with C. Wheeler re: Prolow term sheet. Meeting with D. Thompson re: contents of term sheet; preemptive rights; anti-dilution rights. Telephone conference with R. Hersh re: Prolow note and warrant offering. Review Alpine documentation re: anti-dilution and preemptive rights.
01/12/01 C WHEELER	.50	Arrange for follow up on investigation; check on status of documentation for Prolow loan
01/12/01 M ROBBINS	1.25	Review certificate of designation re: anti-dilution provisions. Review investor rights agreement re: preemptive rights. Meeting with R. Hersh re: \$600,000 private offering. E-mail to D. Thompson re: term sheet.
01/15/01 D THOMPSON II	.50	Conference with Attorney Mara Lerner Robbins re investment issues.
01/15/01 C WHEELER	.50	Follow up on status



Lorraine Christine Hoffman, Esq.
Assistant Staff Counsel
The Florida Bar
File No. 2003-51, 109(15C)

01/16/01 M ROBBINS 2.50 Preparation of Tiedemann Prolow subscription documents. Telephone conferences with R. Hersh.

01/17/01 D THOMPSON II 2.00 Review and revise Subscription Booklet, Convertible Note and Warrant for Tiedemann offering.

01/17/01 M ROBBINS 3.50 Draft and preparation of Warrant Agreement. Draft and preparation of Convertible Promissory Note. Modifications to Subscription Documents. Memo to D. Thompson. Telephone conferences with R. Hersh.

01/18/01 D THOMPSON II .75 Conference with Attorney Mara Lerner Robbins re reorganization and stock issuances.

01/18/01 M ROBBINS 3.50 Preparation of subscription agreement, convertible note and warrant. Meeting with D. Thompson re: comments to Tiedemann investment documents. Inter-office conferences with G. Coleman re: risk factors. Meeting with Rocky Thompson re: stock split. Inter-office conference with A. Levy re: stock split.

01/23/01 C WHEELER .50 Meeting with principals of Internet train

01/23/01 C WHEELER 1.00 Meeting with Mr. Utley and Gayle Coleman

01/23/01 C WHEELER .50 Conf with Mr. Utley re follow up

01/23/01 M ROBBINS 1.75 Review file re: share exchange with minority iviewit Technologies stockholders. Telephone conference with R. Hersh re: Tiedemann Prolow offering. Meeting with R. Hersh re: same. Modifications to offering documents.

01/23/01 G COLEMAN 2.00 Conference with B. Utley and C. Wheeler. Draft letter of intent. Telephone conferences with B. Utley. Revise letter of intent. Forward same.

01/24/01 C WHEELER 1.00 Conf with Mr. Utley; revise letter of intent

01/24/01 C WHEELER 1.00 Revision of document

01/24/01 M ROBBINS 1.50 Modifications to Tiedemann Prolow investment documents. Telephone conferences with R. Hersh. Correspondence to B. Utley re: draft investment documents. Review file re: share exchange with minority iviewit Technologies stockholders. Review memoranda re: same.



Lorraine Christine Hoffman, Esq.
Assistant Staff Counsel
The Florida Bar
File No. 2003-51, 109(15C)

01/29/01 M ROBBINS 1.00 Meeting with Rocky Thompson re: tax matters relative to share exchange options. Review file re: form of Share Exchange Option Agreement. Review form of Share Exchange Option Agreement.

01/30/01 D THOMPSON II .25 Review Exchange Agreement.

01/30/01 M ROBBINS 3.25 Draft and preparation of form of Share Exchange Agreement for minority subsidiary shareholders. Inter-office conference with Jill Zamas re: previous execution of share exchange option agreement. Correspondence to Brian Utley re: execution of Share Exchange Option Agreements. Meeting with Chris Wheeler re: Tiedemann subscription documents. Call to Craig Smith.

01/30/01 J ZAMMAS .75 Review files regarding Share Exchange Agreement for M. Robbins.

02/02/01 D THOMPSON II .75 Meeting with Brian Utley re pending projects.

02/02/01 C WHEELER .50 Conf with Mr. Prolow

02/02/01 M ROBBINS .75 Inter-office conference with Rocky Thompson re: Share Exchange Agreement. Inter-office conference with A. Levy re: stock split; short-form merger; gift of E. Bernstein shares. Inter-office conference with J. Zamas re: Iantoni notes.

02/05/01 C WHEELER 2.50 Meeting as to structure of Internet train acquisition

02/05/01 C WHEELER .50 Correspondence re intellectual property follow up

02/07/01 D THOMPSON II 1.75 Review Tiedemann documents; Follow-up re same; Telephone conference with Craig Smith.

02/07/01 A LEVY .50 General corporate matters; OC with DET re stock split.

02/09/01 D THOMPSON II 1.25 Telephone conference with Ray Hersh re Tiedemann Prolow investment; revise docs.

02/09/01 A LEVY .50 General corporate matters.

02/11/01 D THOMPSON II .50 Review and revise Tiedemann documents.

02/12/01 D THOMPSON II 1.75 Review and analysis of anti-dilution protection in connection with Tiedemann purchase.



Lorraine Christine Hoffman, Esq.
Assistant Staff Counsel
The Florida Bar
File No. 2003-51, 109(15C)

03/14/01 D THOMPSON II 4.25 Prepare Acquisition Agreements; Telephone conference with Ray Hersh re same.

03/14/01 C WHEELER 1.00 Follow up on acquisition status; conf with Mr. Utley; receipt of note

03/14/01 A LEVY 1.00 Mtng with B. Utley and R. Hersh and preparation therefor.

03/15/01 S KAPP .75 Conf. with CCW re: rvw of note, rvw note and mark comments for CCW

03/15/01 S KAPP .25 T/c with B. Utley re: modifications and differences btwn executed note and current note

03/15/01 D THOMPSON II 5.75 Prepare Asset Purchase Agreement and begin Plan of Exchange.

03/15/01 D THOMPSON II .25 Conference re promissory note with Attorney Stuart Kapp.

03/16/01 D THOMPSON II 4.75 Prepare ITrain Agreements for Agreement and Plan of Exchange.

03/16/01 C WHEELER 1.00 Conf with Mr. Thompson re preparation of contracts; conf with Mr. Utley re same; conf as to promissory note and transmittal of funds

03/19/01 D THOMPSON II 2.25 Meeting with Brian Utley and Ray Hersh re OP and Internet Train.

03/19/01 D THOMPSON II 2.75 Review OP and Internet Train documentation.

03/19/01 D THOMPSON II .25 Revise Tiedemann Prolow documentation.

03/19/01 C WHEELER 1.00 Review of agreement

03/19/01 J ZAMMAS 6.00 Work on closing checklist; resolutions and Bills of Sale.



Lorraine Christine Hoffman, Esq.
Assistant Staff Counsel
The Florida Bar
File No. 2003-51, 109(15C)

03/20/01 D THOMPSON II 1.50 Prepare Exhibits to Purchase and Exchange Agreements with paralegal Jill Zammass re closing checklist and documentation.

03/20/01 D THOMPSON II .25 Send out Tiedemann/Prolow documentation.

03/20/01 C WHEELER .50 Review of status of acquisition documents

03/20/01 C WHEELER .50 Review of Agreement and Plan of Exchange; Review of Agreement for Purchase and Sale of Assets

03/20/01 J ZAMMAS 3.00 Work on closing checklist and preparation of Assignment and Assumption Agreement.

03/21/01 D THOMPSON II .75 Follow-up on ITrain and Original Productions deals.

03/21/01 C WHEELER .25 Review of Subscription correspondence to Tiedemann/Prolow

03/27/01 J ZAMMAS .25 Have Greg Reed in the NY office perform a federal trademark search on iLearnit.

03/29/01 J ZAMMAS .25 Contact Greg Reed in NY office regarding preliminary trademark search on iLearnit, Inc.

03/30/01 J ZAMMAS .25 Follow up with Gregg Reed regarding trademark search.

03/30/01 S GORDON .75 Preliminary trademark search for ILEARNIT.

Then later from his deposition we find that he does have knowledge and in fact performed an opinion for Mr. Prolow of course the opinions for investors in Mr. Wheeler's opinions did not need review from patent counsel regarding the patents:

14 A. Must be dealing with additional money from
15 Alpine. Or - or it could be a combination thereof,
16 because on the next page there is discussion of Prolow
17 and financing. So some of the parties investing money
18 needed opinions from us. They would be opinions on
19 the corporate status.

p.200 Christopher Wheeler deposition



Lorraine Christine Hoffman, Esq.
Assistant Staff Counsel
The Florida Bar
File No. 2003-51, 109(15C)

Now, almost a year after the investment was made CEO Lamont, who was not present when this loan was made, went to meet Mr. Prolow to have documents for the loan finally completed. Neither Iviewit nor Mr. Prolow had a signed convertible promissory note for the transfer of the monies or the transfer of the securities, which Mr. Wheeler and Proskauer were to have secured. What the Bar of Florida may also note here, is that it has been alleged that the loan was purported to be for \$1 million dollars and then it appears that Iviewit was only given \$345,000. At the very same time, as will be evidenced; a briefcase of cash from an investor is walked off the Iviewit premises by Wheeler's hand picked management team with highly proprietary computers containing the patent processes as attested by employees in the evidence later submitted. What's more remarkable is that the employees, the computers and perhaps the missing money, end up at a Distance Learning Company that is partially owned by Mr. Wheeler's friend Mr. Prolow.



Lorraine Christine Hoffman, Esq.
Assistant Staff Counsel
The Florida Bar
File No. 2003-51, 109(15C)



IVIEWIT HOLDINGS, INC.

P. Stephen Lamont
Chief Executive Officer
Direct Dial: 914-217-0038

April 15, 2003

Bruce T. Prolow
General Partner
Tiedemann/Prowlow, LLC
535 Madison Avenue
New York, N.Y. 10022

Re: Former Iviewit Board Director?

Dear Bruce:

Again, I was glad to clear up our affairs with respect to the \$345,000 note, as strict recording keeping is one of my own personal hot buttons.

In any event, I am writing for another reason as I came across a piece of disturbing information earlier today. I stumbled upon some documentation that named you as a Board Director of the company somewhere between April 2001 and October 2001.

Moreover, recalling your own words of a distance learning company that you are affiliated with or a part owner of, currently run by or who currently employs a former Iviewit officer and director, troubles me to a certain extent when I view you as a former board member, if you ever held such a designation.

Further, and I should not be relaying this to you, but there are rumors swirling around the company with finger pointing and all from Florida to Los Angeles wherein in catches the jet stream and arrives very soon in New York of alleged breaches of confidentiality pertaining to Iviewit technology, equipment transfers, transfers of trade secrets, and, even in certain circumstances, outright misappropriation of company funds, encased in suitcases full of cash, from Iviewit to some un-named distance learning company in the northeast. Additionally, and I realize we do not know each other very well, but you might know something of my background from the business plan and know that one of my alma maters, Columbia Law School, is not known for its lack of first class materials in the corporate governance area.

As such, I would ask an explanation of these rumors and allegations from you either in a reply, or preferably a phone call, as my aim, as always, is not to harm but champion the



Lorraine Christine Hoffman, Esq.
Assistant Staff Counsel
The Florida Bar
File No. 2003-51, 109(15C)



Bruce Prolow
April 15, 2003
Page 2

cause of our board and the shareholders I serve in the best way I know possible, the fiduciarly responsible way on all points.

Lastly, I ordered a full legal and accounting audit of the company many weeks ago, and I expect the completion of same shortly, so I look forward to hearing from you soon.

Very truly yours,

P. Stephen Lamont
Chief Executive Officer



Lorraine Christine Hoffman, Esq.
Assistant Staff Counsel
The Florida Bar
File No. 2003-51, 109(15C)

Further Mr. Lamont's recollection of the events leading up to his having to have documents executed a year after the transaction.



Lorraine Christine Hoffman, Esq.
Assistant Staff Counsel
The Florida Bar
File No. 2003-51, 109(15C)

Eliot I. Bernstein

Subject: FW: Tiedemann Prolow
Importance: High

-----Original Message-----

From: P. Stephen Lamont [mailto:pstephen.lamont@verizon.net]
Sent: Tuesday, April 15, 2003 3:06 PM
To: Eliot I. Bernstein (E-mail)
Subject: Tiedemann Prolow
Importance: High

In early January 2002, upon the suggestion of former director Simon Bernstein, I participated in a three way conference call with Bruce Prolow and Craig Smith (Eliot Bernstein and William Kasser introduced me and quickly exited), a principal and analyst, respectively of the Tiedemann/Prolow investor in question. A pleasant conversation I recall, and Mr. Prolow asked what was my going forward strategy for the company, and we discussed some of my plans. Later, Mr. Prolow mentioned that he had never received executed documents pertaining to what he had described as a \$345,000 Convertible Promissory Note ("CPN"). Recalling what havoc was caused by faulty record keeping at my just prior employer, I assured Mr. Prolow that I could take corrective action, and we set a time to meet.

Later that month, in the Madison Avenue offices of Mr. Prolow, I pitched a new investment by his group into Iviewit, and discussed some of the terms and conditions that seemed unusual in the draft CPN note I received from William R. Kasser, wherein Mr. Kasser stated that to the best of his recollection, was the final unexecuted draft of the CPN. In any event, Mr. Prolow passed off judgment on an additional investment to his analyst, Craig Smith, and we set another meeting the next week to discuss same, or a conversion, in part or whole, of their CPN, and execution of their CPN. That very next week, Mr. Smith on behalf of Tiedemann/Prolow declined the new investment, and directly afterwards I executed the received from Mr. Kasser CPN in the following manner: Eliot I. Bernstein by P. Stephen Lamont his attorney-in-fact. Mind you, this action was not taken unilaterally and was discussed several times within the company, but no formal board of directors was in place at the time to review and approve execution of the CPN.

Saint Stephen: Pslam 1, Verse 1: "Blessed art thou who get a new printer ribbon and share their secretary!!!!!!"

Best regards,

P. Stephen Lamont
Chief Executive Officer
Iviewit Holdings, Inc.
10158 Stonehenge Circle
Boynton Beach, Fla. 33437
Tel.: 914-217-0038
Email: pstephen.lamont@verizon.net; 9142170038@mobile.att.net
URL: www.iviewit.com

THIS MESSAGE AND ITS EMBEDDED AND/OR ATTACHED FILES INCORPORATED HEREIN BY REFERENCE CONTAIN INFORMATION THAT IS PROPRIETARY AND CONFIDENTIAL, PRIVILEGED INFORMATION. IF YOU ARE NOT THE INTENDED RECIPIENT, YOU ARE PROHIBITED FROM READING, OPENING, PRINTING, COPYING, FORWARDING, OR SAVING THIS MAIL AND ITS EMBEDDED AND/OR ATTACHED FILES. PLEASE DELETE THE MESSAGE



Lorraine Christine Hoffman, Esq.
Assistant Staff Counsel
The Florida Bar
File No. 2003-51, 109(15C)

We submit as evidence a letter to Mr. Prolow from CEO Lamont that asks for information regarding stolen computers that were taken by Mr. Utley as he left Iviewit, as evidenced in the attached police report and transferred to a company that Mr. Prolow was a director of. After his termination from Iviewit Mr. Utley was employed by Mr. Prolow's Company Internettrain which posed all kinds of conflicts for Mr. Prolow as a Board member of Iviewit and violated Mr. Utley's employment and non-compete agreement, attached as [Exhibit B](#):



Lorraine Christine Hoffman, Esq.
Assistant Staff Counsel
The Florida Bar
File No. 2003-51, 109(15C)

Page 1 of 2

Eliot I. Bernstein

Subject: FW: Iviewit
Importance: High

-----Original Message-----

From: P. Stephen Lamont [mailto:pstephen.lamont@verizon.net]
Sent: Thursday, April 25, 2002 1:59 AM
To: bprolow@tiedemanntrust.com; bprolow@Tiedemannfunds.com
Cc: Eliot I. Bernstein
Subject: Re: Iviewit
Importance: High

Bruce,

I must insist on being copied on all matters pertaining to Iviewit and Tiedemann/Prolow, and unfortunately you omitted me on the below message to Eliot Bernstein. Moreover, I found your clarifications lacking in a few areas, and would appreciate clarification of the below:

Question: Has there been any instances of equipment transfers from Iviewit to you personally or any of your affiliated companies (where affiliate is defined as a five (5) or more percent voting shareholder or one that directly or indirectly controls another)?

Question: Has there been any transfers of Iviewit trade secrets to you personally or any of your affiliated companies (where affiliate is defined as a five (5) or more percent voting shareholder or one that directly or indirectly controls another)?

Question: Are you now aware, or were you at anytime aware, of why former Iviewit employees would allege that a suitcase full of cash in Brian Utley's office was either: (i) the \$345,000 Convertible Note funded by Tiedemann/Prolow LLC or (ii) that Tiedemann/Prolow funded an amount in excess of \$345,000 and that the balance was encased in that suitcase full of cash?

Question: Given the definition of affiliate as a five (5) or more percent voting shareholder or one that directly or indirectly controls another would you recharacterize your clarifications 1 through 5 in your email directly below?

Best regards,

P. Stephen Lamont
Chief Executive Officer
I View It Technologies, Inc.
10 Mela
Rancho Palos Verdes, Cal. 90275
Tel: (914) 217-0038
email: pstephen.lamont@verizon.net

----- Original Message -----

From: "Eliot I. Bernstein" <eliot.bernstein@verizon.net>
To: "Simon L. Bernstein (E-mail)" <simon@adelphia.net>; "P. Stephen Lamont (E-mail 2)" <pstephen.lamont@verizon.net>; "Caroline Prochotska Rogers (E-mail)" <caroline@cprogers.com>
Sent: Wednesday, April 24, 2002 3:33 PM

4/15/2003



Lorraine Christine Hoffman, Esq.
Assistant Staff Counsel
The Florida Bar
File No. 2003-51, 109(15C)

Page 2 of 2

Subject: FW: Iviewit - is this ok?

>
>
> -----Original Message-----
> From: Bruce Prolow [mailto:bprolow@Tiedemannfunds.com]
> Sent: Wednesday, April 24, 2002 2:02 PM
> To: 'eliot.bernstein@verizon.net'
> Subject: FW: Iviewit - is this ok?
>
>
>
>> Hi Eliot:
>>
>> To summarize, here are the clarifications:
>>
>> 1. I am Managing Member of Tiedemann Prolow.
>> 2. Tiedemann Prolow does not employ Brian Utley; nor is he affiliated with
>> Tiedemann Prolow as a member or consultant.
>> Brian is an executive of Internettrain. I am a director of Internettrain
>> and Tiedemann Prolow is a passive investor in Internettrain.
>> 3. I introduced Internettrain to Iviewit as a potential client of Iviewit
>> and user of its technology. To the best of my knowledge, this
>> introduction was made shortly after I met Iviewit and before both (i)
>> the investment by Tiedemann Prolow into Iviewit and (ii) I became a
>> director of Iviewit (it was a friendly referral/introduction of what I
>> believed at the time to be two complementary companies). To my knowledge,
>> Internettrain has never utilized any of Iviewit's proprietary technology.
>> 4. All funds invested by Tiedemann Prolow into Iviewit were sent in a
>> single wire to Iviewit's account. Proof of the wire transfer of funds
>> will be sent under separate cover. No funds intended for investment by
>> Tiedemann Prolow into Iviewit (or any other company) were ever transferred
>> directly or indirectly to Brian Utley.
>> 5. Neither I nor any member of Tiedemann Prolow have ever benefited,
>> directly or indirectly, from transactions by or between Iviewit and myself
>> or affiliated companies (in fact, the entire relationship with Iviewit has
>> involved only an investment by Tiedemann Prolow, and expenses borne by
>> Tiedemann Prolow which were related to the Board membership).
>>
>> I am sure that this answers your questions. Please contact me directly
>> with any further questions.
>>
>> Please keep us informed of your progress. I trust that you will be able
>> to come to some satisfactory resolution that is in the best interests of
>> the company and its investors.
>>
>> Regards,
>>
>> Bruce
>>
>>
>

Incoming mail is certified Virus Free.
Checked by AVG anti-virus system (<http://www.grisoft.com>).
Version: 6.0.471 / Virus Database: 269 - Release Date: 4/10/2003

4/15/2003



Lorraine Christine Hoffman, Esq.
Assistant Staff Counsel
The Florida Bar
File No. 2003-51, 109(15C)

The documents that were later signed by Brian Utley and Raymond Hersh and prepared by Proskauer Rose LLP come two months month after the transaction and again without Board approval and missing the convertible note which was signed a year later by Mr. Lamont.

We submit the wire transfer information sent to the Company a year later by Mr. Prolow:



Lorraine Christine Hoffman, Esq.
 Assistant Staff Counsel
 The Florida Bar
 File No. 2003-51, 109(15C)

U

04/25/02 09:55:18

BROWSE/REPRINT

ACCOUNT	DATE TIME	STATUS	TYPE	AMOUNT	MMKT
[REDACTED]	0605 14:38	AUTH	WIRE	[REDACTED]	
[REDACTED]	0223 15:23	AUTH	WIRE	345,000.00	*

4 SCROLL
 144.14.15.99
 TCPBCA13 8/2

[Handwritten notes]
 L/inst, page 1 of 2
 shows Amount / DATE / TIME
 shows BANK / DATE / TIME / FED REF #

15:26



Lorraine Christine Hoffman, Esq.
 Assistant Staff Counsel
 The Florida Bar
 File No. 2003-51, 109(15C)

(2)

```

WIRE DETAIL                                04/24/02 21:55:30.3
USD
WIRE FROM: FIEDEMANN / PROLOW, LLC
WIRE TO:
AMOUNT: 15:23:48 02/23
PAYMENT PRIORITY: L
CLERK/SUPERVISOR: M31045
DATE: 04/24/02 14:50:57
WIRE CONF: 20010223B1Q8024C005377 16:05
FED REF ↑
FEDERATION NATIONAL BK OF FLO
MORNINGVILLE FL 32203
FEDERATION NATIONAL BANK
B/O SAME: Y
FORMER REQUEST
MDTS
6 BALANCES 7 EDITS
TCPBCA13 2/1
144.14.15.99
  
```

** TOTAL PAGE. 02 **

The documents completed for the transaction occur after the transaction, the fact that it been transmitted earlier was already a large concern for the shareholders, board of director members, investors and other legal counsel, as the documents for the transaction



Lorraine Christine Hoffman, Esq.
Assistant Staff Counsel
The Florida Bar
File No. 2003-51, 109(15C)

were never sent to the Board. We submit these documents as [Exhibit B](#). As you will see on these documents it is Proskauer Rose footers that are imprinted on 3/20/01, a month after the transfer and further the warrant is not a part of their closing documents. The warrant is drafted, executed and sent by Raymond Hersh two months after the transaction and a month after the Proskauer documents are supposedly signed and has a different amount of stock than the Proskauer Rose documents. Also discovered was that without Board approval or knowledge, Mr. Utley and Mr. Wheeler had been preparing to sell/merge the Company to Mr. Prolow's Company and transfer with this transaction the assets of Iviewit. When Mr. Utley proposed this plan at a Board meeting with the New Jersey Company members involved, they were asked to leave the Board meeting and Mr. Utley was removed from his corporate responsibilities.

So this led to a questioning of the transaction that Mr. Wheeler had orchestrated with Mr. Utley and Mr. Prolow and Wheeler was asked to attend meetings of the Board before it disbanded, in which he could address this most bizarre transaction and several of the patent issues that were arising, issues concerning Mr. Utley improperly filing patents that he and Mr. Wheeler were overseeing, as will be evidenced further in this rebuttal. Instead of showing up to the Board meetings to explain, Mr. Wheeler failed to attend any of the final meetings and the Board, Board members began to get nervous and all began to resign fearing repercussions from these actions. Immediately after Mr. Utley was fired, Mr. Wheeler supposedly wrote a letter to Mr. Utley withdrawing Proskauer's services. As the investigations into what had happened began, both Mr. Utley and Mr. Wheeler filed actions against the Company in an attempt to bankrupt it and gain claims against the Intellectual Property that they had tried repeatedly to steal while in positions of management. Now Mr. Utley in his final days gave the employees no notice of termination as directed by the Board weeks in advance of the closure of the Boca Raton office and then he and his longtime friend Mr. Utley and another Wheeler referral Mr. Mike Reale, tried to bribe employees with a briefcase of cash on the last day of their employment, to steal patent processes, proprietary equipment, trade secrets, etc. and even claim that the cash was from an investor, perhaps this is why the documentation on the Tiedemann/Prolow loan is missing.

From Mr. Wheeler's deposition we submit on a transaction he authored with Mr. Utley for a friend of his with no COI signed Mr. Carl Tiedemann and Mr. Bruce Prolow:



Lorraine Christine Hoffman, Esq.
Assistant Staff Counsel
The Florida Bar
File No. 2003-51, 109(15C)

1 Q. Okay.

2 A. And I'm not so sure everyone participated,
3 but to a great extent, many did.

4 Q. Now, Bruce Prolow was another individual
5 who you indicated - Prolow, rather, was an individual
6 you indicated also invested?

7 A. Well, he had a group. I mean, he was a
8 person introduced to the company, but he - he -- I
9 don't know how his money came in. I don't know how it
10 was -- Don't know if it came in from one or two
11 investors or whatever.

12 MR. TRIGGS: Just do this. If this will
13 speed us up, the question was asked I think is
14 something about whether Bruce Prolow put money
15 in. Just - he wants you to answer the question
16 that he's asking, and it will speed us up if you
17 just answer the question he's asking.

18 A. I don't know.

19 Q. Okay. Do you know how much money came in
20 from Mr. Prolow?

21 A. No. 

22 Q. Were you involved in preparing the
23 transactional documents with regard to any funding
24 that Mr. Prolow provided to iviewit?

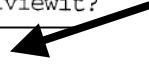
25 A. I can't remember. 

KEN SCHANZER & ASSOCIATES, INC. (954) 922-2660



Lorraine Christine Hoffman, Esq.
Assistant Staff Counsel
The Florida Bar
File No. 2003-51, 109(15C)

We respectfully ask the Bar of Florida to call the following individuals directly for their statements in the following matters of stolen money and stolen equipment:

1. Matthew Mink
2. Zakirul Shirajee – Have taped testimony
3. Anthony Frenden – Have written testimony submitted

below

We submit the following evidence in this matter:

-----Original Message-----

From: Eliot I. Bernstein [mailto:res0bf4a@verizon.net]

Sent: Wednesday, June 13, 2001 9:21 PM

To: Ross Miller (E-mail); Ross Miller (E-mail 2); William R. Kasser (E-mail); William R. Kasser (E-mail 2); Simon L. Bernstein (E-mail)

Subject: Missing Boca Equipment

Please read this email from Matt Mink it clearly indicates that Mike and Brian have iviewit equipment.

-----Original Message-----

From: Minkvideo@aol.com [mailto:Minkvideo@aol.com]

Sent: Wednesday, June 13, 2001 4:50 AM

To: tyrexden@yahoo.com

Subject: Re:

Tony,

Everything is good. I finally have my computer back and I am editing again. I am trying a little marketing right now. I have an ad going into a local vendors magazine and I have been meeting and contacting other video companies in my field to let them know that I am available to shoot and edit. I met with Zakirul one day at his school and everything seems to be going well with him too. Mike Reale has contacted me twice too. I guess he has the bomber and the computer I worked on and there is an administration password he can't get by. I couldn't help him there. I guess Tammy won't help him out.

When my computer went down I lost Dreamweaver, Fireworks and my encoders. I didn't have any backups for them. I know better this time. I am backing up everything.

Take care and I'll talk to you soon.

Matt



Lorraine Christine Hoffman, Esq.
Assistant Staff Counsel
The Florida Bar
File No. 2003-51, 109(15C)

-----Original Message-----

From: Minkvideo@aol.com [mailto:Minkvideo@aol.com]
Sent: Wednesday, May 01, 2002 5:15 PM
To: t.rex3@verizon.net
Subject: Re: from Tony!

speaking of New Jersey....Mike Reale called me after i was let go....could have been a few weeks to a month about passcodes to computers and if I wanted to go to New Jersey to help set up their new operation with the distance learning because I knew the iviewit processes. If you mean stuff like that let me know

Matthew

And we submit Mr. Frenden's testimony



Lorraine Christine Hoffman, Esq.
Assistant Staff Counsel
The Florida Bar
File No. 2003-51, 109(15C)

March 28, 2002.

This is my recollection of the events last year, which took place after the Iviewit staff was informed that the company would soon be closing, and we were all losing our jobs:

Shortly after a conference room meeting with people who Scott Murphy brought in, a videotape is brought into the lab. It is made clear that the tape belongs to Scott Murphy's associates, and I am instructed to give the utmost care and attention to encoding this tape, which is of pornographic nature. The number \$7 million is repeatedly mentioned as possible revenue should Iviewit get this pornography account. The tape is initially previewed in the lab when Mike Reale plays it in a VCR. I am present, along with Tammy Raymond, Network Administrator, and Courtney Jurcak, a teenage female technician. I believe Matthew Mink was also there. The tape is played using zero discretion. I am instructed to do my best in encoding this material, because as it was put to me, the deal could possibly serve in saving the company and everyone's job. To make clear, this episode all happened after a conference room meeting, in which Brian Utley announced to all Iviewit employees that the company was closing, effective immediately. After this announcement, and before the porno tape came in, my self-given job responsibilities included make closure to the Iviewit Boca Raton lab by packing away equipment for West Coast shipment, and informing our current clients that we would be doing no more work for them. I ran a very generalized encoding session over the porno tape. I remember meeting one of the main slimeball porno guys during this general time. He pointed at my computer screen and told me he needed the videos to look better than they did so he could offer something on his porno sites that no one else had. I didn't bother to use any special proprietary processes on the video because I was not personally motivated to do a good job on the tape. Approximately, the next day, I am summoned to the conference room where sits Brian Utley and Raymond Hersh. There is a large TV web monitor at the end of the conference table connected to the Internet, and I am instructed to use it to play the porno video which I encoded, and was now streaming live from our streaming server. I play the video, they watch. Comment on various visualities from the encode. They ask me questions. I am slightly embarrassed and want no part of it, and made a decision to myself that had they asked me to do further work for this client, I would decline. I was very shocked at the casual demeanor of these two men during this conference room porno review. Up to that point, and since the day I began at the company, I was informed that Iviewit would never have anything to do with adult content. The technology simply would not be used for those avenues, and I was made aware that stockholders and board members specifically stipulated these points. **During this general time, (but a bit later, because I**



Lorraine Christine Hoffman, Esq.
Assistant Staff Counsel
The Florida Bar
File No. 2003-51, 109(15C)

remember some of the other technicians had already worked their last day), Mike Reale brings in a gray suitcase into the lab. The suitcase is constructed of a very durable nature and locking mechanisms. He opens it in front of me, and it's the most money I've ever seen in my life. Tammy Raymond was there, and later claimed that she thought it was fake because there was so much of it, but I was inches from it, and it looked like perfectly real stacks and stacks of one hundred dollar bills, and neatly arranged like in the movies. I asked Reale where this came from. I don't remember whom he said, but it was a name familiar to me as someone who didn't work in our office but had direct investment relations with Iviewit.

I swear the above to be true and complete, to the best of my recollection.

Anthony Frenden
841 Manhattan Avenue #9
Hermosa Beach CA 90254

And at this point it was clear they had stolen equipment and a police report was made and once the Computers were returned we found they had been accessed and used for Production at the Company Internet Train where Mr. Utley was working for Mr. Prolow.

-----Original Message-----

From: Bill Kasser [mailto:bill@iviewit.com]
Sent: Tuesday, July 17, 2001 8:55 AM
To: Tony Frenden
Subject: Encoding Machines

How are the Bomber & Nitro? Did Brian do any damage? Did he leave a record of what he did?
Bill



Lorraine Christine Hoffman, Esq.
Assistant Staff Counsel
The Florida Bar
File No. 2003-51, 109(15C)

-----Original Message-----

From: Tony Frenden [mailto:tyrex.den@verizon.net]
Sent: Thursday, July 19, 2001 1:39 AM
To: 'Bill Kasser'
Subject: RE: Encoding Machines

Bill,
Both machines were accessed, and used during the time they weren't in our hands. On the Bomber, i didn't find any streaming media files, but it was indicated that the encoding software (to create streaming files) had been used frequently. On the Nitro, i have not yet searched for streaming files, but i did find many images that pertain to the InternetTrane product. These images were to appear as pages within InternetTrane's software. These files were created by someone using the Nitro in early June.

It was shown that both machines were part of a network environment together, while in our absence. The drives of each computer was 'shared' or accessible to the other computer. Bomber's drive was called 'Production', while the Nitro was named "Video". Furthermore, the Bomber recieved an upgrade of its 'operating system' (from Windows NT to Windows 2000) to facillitate its network environment. I don't believe the Windows 2000 upgrade to be legitimate.

A side note reveals that both computers had pirated software installed on them in June or July, and files resulting from them were created as late as July 11, 2001.

If you require further details, let me know.

Tony Frenden

We submit Mssrs: Utley/Reale Police Report

Frightening but true, Brian and Mike steal highly proprietary equipment worth a fortune in proprietary software and confidential iviewit processes. After lying about what they were taking and lying to the police they are confronted to return the machines which they have taken to a distance learning part owned by our investor Tiedeman/Prolow's distance learning company. Without the testimony of Matthew Mink that they had contacted him for passwords we would have never recovered the machine as Utley had stated to the Company that he did not possess such machines.



Lorraine Christine Hoffman, Esq.
 Assistant Staff Counsel
 The Florida Bar
 File No. 2003-51, 109(15C)

		INCIDENT/INVESTIGATION REPORT						Case#		
Agency Name		Boca Raton Police Department						2001-054580		
ORI		0500200						Date / Time Reported		
								06/20/2001 10:12 Wed		
Location of Incident		Premise Type		Zone/Tract		Last Known Secure		At Found		
2255 W Glades Rd - STE 337 W, Boca Raton FL		Commercial / Office		41		04/27/2001 10:12 Fri		05/18/2001 10:12 Fri		
I N C I D E N T D A T A	#1	Crime Incident(s)		Weapon / Tools		Exit		Security		
		Embezzlement (Com)		NONE/NOT APPLICABLE				Activity		
		EMB								
#2	Crime Incident ()		Weapon / Tools		Exit		Security		Activity	
#3	Crime Incident ()		Weapon / Tools		Exit		Security		Activity	
MO Alarm/No Alarm, Method Of Entry/No Force, Object Of Entry/Office Equipment, Presence Of Victim/On Premises										
# of Victims 1 Type: BUSINESS Injury: 0 Domestic: N										
V I C T I M	Victim/Business Name (Last, First, Middle)		Victim of Crime #		DOB		Resident Status		Military Branch/Status	
	IVIEWIT.COM, INC.		1		Age		Resident			
	Home Address		Employer Name/Address		Home Phone		Business Phone			
2255 W GLADES RD - 337W, Boca Raton, FL 33431-				561-999-8899						
VYR		Make		Model		Style		Color		Lic/Lis
										VIN
CODES: V- Victim (Denote V2, V3) O = Owner (if other than victim) R = Reporting Person (if other than victim)										
Type: INDIVIDUAL (NOT A LE OFFICER)										
O T H E R S	Code Name (Last, First, Middle)		Victim of Crime #		DOB		Resident Status		Military Branch/Status	
	CM KASSER, WILLIAM				Age 53		W M			
	Home Address		Employer Name/Address		Home Phone		Business Phone			
991 Nw 9th St Boca Raton, FL 33486		Iviewit.com, Inc, 2255 W Glades Rd (CONTROLLER)		561-999-8899		561-999-8899				
Type: INDIVIDUAL (NOT A LE OFFICER)										
I N V O L V E D	Code Name (Last, First, Middle)		Victim of Crime #		DOB		Resident Status		Military Branch/Status	
	SB REALE, MICHAEL				Age 30		W M			
	Home Address		Employer Name/Address		Home Phone		Business Phone			
5304 Ventura Dr Delray Beach, FL 33484				561-499-8850						
1 = None 2 = Burned 3 = Counterfeit / Forged 4 = Damaged / Vandalized 5 = Recovered 6 = Seized 7 = Stolen 8 = Unknown ("OJ" = Recovered for Other Jurisdiction)										
P R O P E R T Y	VI #	Code	Status From/To	Value	OJ	QTY	Property Description	Make/Model	Serial Number	
Officer/ID#		ULLOA, J. (TRAF) (A351)				Total Stolen Value: \$40,000.00				
Invest ID#		MEYER, S. P. (ISD, ISD) (528)				Supervisor DIXON, C. (PATL, A2)				
Complainant Signature		Case Status		Case Disposition:						
		Exceptionally		Exceptionally Cleared						
		08/10/2001		08/10/2001		Page 1				
Printed By: PNEWELL, RECORDS3						Sys#: 351041		02/27/2002 10:35:32		



Lorraine Christine Hoffman, Esq.
Assistant Staff Counsel
The Florida Bar
File No. 2003-51, 109(15C)

Incident Report Additional Name List

Boca Raton Police Department

OCA: 2001-054580

Additional Name List

NameCode/#	Name (Last, First, Middle)	Victim of Crime #	DOB	Age	Race	Sex
1) SB 2	UTLEY, BRIAN		10/27/1932	68	W	M
	Address 1930 Sw 8th St, Boca Raton, FL 33486-					
	Empl/Addr		H: 561-750-6876			
			B: 561-289-8145			



Lorraine Christine Hoffman, Esq.
Assistant Staff Counsel
The Florida Bar
File No. 2003-51, 109(15C)

INCIDENT/INVESTIGATION REPORT

Boca Raton Police Department

Page 2

By: PNEWELL, RECORDS3 02/27/2002

Case# 2001-054580

Status Codes 1 = None 2 = Burned 3 = Counterfeit / Forged 4 = Damaged 5 = Recovered 6 = Seized 7 = Stolen 8 = Unknown							
UCR	Status	Quantity	Type Measure	Suspected Type	Up to 3 types of activity		
D							
R							
U							
G							
S							
Assisting Officers							
Suspect Hate / Bias Motivated: <i>None (No bias)</i>							
N A R R A T I V E	WILLIAM KASSER OF IVIEWIT.COM ADVISED THAT 2 DELL MODIFIED COMPUTER/ENCODING MACHINES (MODEL AND SERIAL# UNKNOWN)(\$40,000.00), WERE STOLEN FROM THEIR BUSINESS BY THE COMPANY'S EX-PRESIDENT AND V.P. OF OPERATIONS.						



Lorraine Christine Hoffman, Esq.
 Assistant Staff Counsel
 The Florida Bar
 File No. 2003-51, 109(15C)

REPORTING OFFICER NARRATIVE

<i>Boca Raton Police Department</i>		OCA 2001-054580
Victim <i>IVIEWIT.COM, INC.</i>	Offense <i>EMBEZZLEMENT</i>	Date / Time Reported <i>Wed 06/20/2001 10:12</i>

ON 06-20-2001 I SPOKE WITH WILLIAM KASSER(CONTROLLER) OF IVIEWIT.COM BY TELEPHONE. KASSER STATED THAT ON 04-27-2001, THE EX-PRESIDENT(BRIAN UTLEY) AND THE V.P. OF OPERATIONS(MICHAEL REALE) FOR THEIR COMPANY, STOLE 2 DELL MODIFIED COMPUTER/ENCODING MACHINES(UNKNOWN MODEL & SERIAL #) THAT WERE VALUED AT \$40,000.00. THE COMPUTERS WERE NAMED "THE BOMBER" AND "THE NITRO".

KASSER ADVISED ME THAT THESE COMPUTERS WERE MODIFIED TO ENCODE VIDEOS AND HAD LARGER DISK DRIVES AND VIDEO ENCODING CARDS INSTALLED. THIS IS WHAT MADE THEM SO VALUABLE. THESE COMPUTERS GENERATED REVENUE FOR THE COMPANY.

KASSER ADVISED ME THAT THEIR COMPANY WAS CLOSING THEIR BOCA OFFICE AT 2255 W. GLADES ROAD AT THE END OF APRIL AND RELOCATING TO CALIFORNIA, AND UTLEY AND REALE WERE BEING TERMINATED AT THAT TIME. ON UTLEY'S LAST DAY, HE HAD ADVISED KASSER THAT HE WAS INTERESTED IN PURCHASING 2 STANDARD DESKTOP COMPUTERS FROM THEM FOR \$1,000.00 A PIECE. KASSER AGREED, UTLEY GAVE 2 SEPARATE CHECKS FOR \$1,000.00 A PIECE, AND AT THAT TIME ALL OF THE COMPUTERS WERE BEING BOXED UP TO BE RELOCATED TO CALIFORNIA.

KASSER STATED THAT REALE WAS SUPERVISING THE PACKING OF THE COMPUTERS AND KNEW EXACTLY WHAT CONTENTS WERE IN EACH BOX. ONCE THE BOXES WERE PACKED, REALE GAVE UTLEY THE OKAY TO TAKE 2 BOXES CONTAINING THE MOST VALUABLE COMPUTERS AND NOT THE BOXES WITH THE STANDARD COMPUTERS.

KASSER THEN STATED THAT HE HAD FOUND OUT APPROXIMATELY 3 WEEKS LATER, ONCE THE BOXES HAD ARRIVED IN CALIFORNIA, THAT THE MOST VALUABLE COMPUTERS WERE NOT DELIVERED. AT THAT TIME, KASSER THEN CONTACTED UTLEY AND UTLEY ADMITTED THAT HIMSELF AND REALE HAD TAKEN THE MOST VALUABLE COMPUTERS AND TOLD KASSER THAT THEY WERE ONLY WORTH \$1,000.00 A PIECE ANYWAY. UTLEY WAS ASKED TO RETURN THESE COMPUTERS AND TAKE THE CORRECT ONES AND HE REFUSED.

I THEN SPOKE WITH ROSS MILLER, WHO IS THE COMPANIES ATTORNEY, WHO ADVISED ME THAT REALE WAS IN CHARGE OF PACKAGING EACH COMPUTER AND WRONGFULLY AND INTENTIONALLY LET UTLEY TAKE THE MOST VALUABLE COMPUTERS, WITHOUT CONSENT FROM ANYONE ELSE IN THE COMPANY. ROSS ALSO CONFIRMED ALL OF THE ABOVE INFORMATION GIVEN BY KASSER. ROSS ADVISED ME THAT HE HAD BEEN TOLD BY SEVERAL 3RD PARTIES THAT REALE AND UTLEY ADMITTED TO HAVING THE ABOVE STATED EQUIPMENT AND ASKED 3RD PARTIES FOR ASSISTANCE IN OPERATING IT. ROSS HAS A SUSPICION THAT THE EQUIPMENT MAY BE USED TO START A BUSINESS FOR REALE AND UTLEY.

ON 06-20-2001 AT 12:28 HOURS, I CONTACTED UTLEY AT 561-750-6876, WHO ADVISED ME THAT HE DID HAVE THE EQUIPMENT, BUT ADVISED THAT THE DEAL WAS STRAIGHT FORWARD AND HE POINTED OUT TO KASSER EXACTLY WHAT COMPUTERS HE WOULD BE TAKING AND ALL WAS AGREED ON. UTLEY ADVISED THAT HE PAID \$1,000.00 PER COMPUTER AND THAT IT WAS A GENEROUS OFFER. UTLEY BELIEVES THAT KASSER MUST HAVE DECIDED AFTER THE FACT THAT HE DID NOT RECEIVE ENOUGH MONEY FOR THESE COMPUTERS AND IS EXAGGERATING ABOUT THEIR \$40,000.00 VALUE.

ON 06-20-2001 AT 13:00 HOURS, I SPOKE WITH REALE AT 561-499-8850, WHO ADVISED ME THAT HE DID NOT HAVE ANY INVOLVEMENT IN ANY COMPUTER THEFT. REALE ADVISED

Reporting Officer: *ULLOA, J.*

Printed By: PNEWELL, RECORDS3 02/27/2002 10:35

Page 3 of



Lorraine Christine Hoffman, Esq.
 Assistant Staff Counsel
 The Florida Bar
 File No. 2003-51, 109(15C)

REPORTING OFFICER NARRATIVE

<i>Boca Raton Police Department</i>		OCA 2001-054580
Victim <i>IVIEWIT.COM, INC.</i>	Offense <i>EMBEZZLEMENT</i>	Date / Time Reported <i>Wed 06/20/2001 10:12</i>

ME THAT UTLEY HAD POINTED OUT THE COMPUTERS THAT HE WAS GOING TO PURCHASE FOR \$1,000.00 EACH AND THAT IS WHAT WAS TAKEN WHEN THEY LEFT THE COMPANY. REALE STATED THAT PAYING \$1,000.00 FOR EACH OF THE COMPUTERS THAT THEY TOOK WAS A VERY GENEROUS OFFER, DUE TO THEIR AGE AND VINTAGE. REALE STATED THAT THE COMPUTERS HAD STANDARD HARDWARE, SO THE VALUE THAT WAS GIVEN BY KASSER WAS WAY ABOVE IT'S FAIR MARKET VALUE. REALE STATED THAT HE HAS MANY YEARS OF EXPERIENCE WITH COMPUTERS AND KNOWS WHAT THEY ARE WORTH. REALE FEELS THAT KASSER'S COMPLAINT IS MOTIVATED BY EMOTIONS AND NOT MONEY.

I ADVISED THE COMPLAINANT TO CONTACT THE P.D. IF THERE IS ANY ADDITIONAL INFORMATION, AND I WAS ASKED BY KASSER TO PLEASE HAVE SOMEONE CONTACT HIM REGARDING AN INVESTIGATION INTO THIS MATTER.

Reporting Officer: *ULLOA, J.*
 Printed By: PNEWELL, RECORDS3 02/27/2002 10:35

Page 4 of



Lorraine Christine Hoffman, Esq.
 Assistant Staff Counsel
 The Florida Bar
 File No. 2003-51, 109(15C)

Incident Report Suspect List

Boca Raton Police Department

OCA: 2001-054580

1	Name (Last, First, Middle) <i>Utley, Brian</i>				Also Known As				Home Address <i>1930 SW 8TH ST BOCA RATON, FL 33486 561-750-6876</i>			
	Business Address <i>561-289-8145</i>											
	DOB. <i>10/27/1932</i>	Age <i>68</i>	Race <i>W</i>	Sex <i>M</i>	Hgt	Wgt	Hair	Eye	Scars, Marks, Tattoos, or other distinguishing features			
<i>Reported Suspect Detail</i>		Suspect Age		Race	Sex	Height		Weight	SSN <i>528-40-3812</i>			
Weapon, Type	Feature	Make		Model		Color	Caliber	Dir of Travel				
VehYr/Make/Model		Drs	Style		Color	Lic/St		Mode of Travel				
Notes						Physical Char						



Lorraine Christine Hoffman, Esq.
 Assistant Staff Counsel
 The Florida Bar
 File No. 2003-51, 109(15C)

CASE SUPPLEMENTAL REPORT
NOT SUPERVISOR APPROVED

Printed: 02/27/2002 10:35

Boca Raton Police Department

OCA: **2001054580**

THE INFORMATION BELOW IS CONFIDENTIAL - FOR USE BY AUTHORIZED PERSONNEL ONLY

Case Status: <i>Exceptionally Cleared</i>	Offense: <i>EMBEZZLEMENT</i>
Case Mng Status: <i>Exceptionally Cleared</i>	Occurred: <i>04/27/2001</i>
Investigator: <i>MEYER, S. P. (528)</i>	Date / Time: <i>08/08/2001 16:17:26, Wednesday</i>
Supervisor: <i>(0)</i>	Supervisor Review Date / Time: <i>NOT REVIEWED</i>
Contact:	Reference: <i>Follow Up</i>

06/26/2001 at 14:00 hours I spoke to William Kasser concerning the theft of computers from Iviewit.Com. William Kasser, who is the Controller for Iviewit.Com, verified that all of the information on the original report was accurate. Kasser advised that the Ex-President of the Boca branch of Iviewit.Com, Brian Utley, stole two Hi-tech computers from the Company after he was terminated from his position.

Kasser found out that the hi-tech computers, the "Nitro" and the "Bomber", were missing when he received a phone call from Eliot Bernstein in California. Kasser was told later by Michael Reale that Brian Utley had the Bomber and the Nitro. Kasser feels that Reale assisted Utley in stealing the computers from the Company when he was packaging the computers.

When Kasser called Utley Kasser asked Utley if he had the bomber and the Nitro. Utley told Kasser that he had the Nitro and Bomber and that he legally purchased the computers from the company for \$1000.00 each. Kasser was present when Utley asked Ross Miller if he could purchase two of the computers from the Company for \$1,000.00 each. Kasser told Utley that the deal was for two of the generic computers, not the Nitro and the Bomber. Kasser told me that Utley knew that the Nitro and the Bomber were worth \$40,000.00. Utley told Kasser that he was not going to return the computers to the Company.

06/27/2001 at 10:30 hours I went to Iviewit.Com and I spoke to Ross Miller concerning this case. According to Miller, Utley approached him on May 3rd while Utley was cleaning out his office. Utley asked Miller if he could purchase his desktop computer and another generic computer from the business. Miller pointed to the generic computers in the general office area and he stated, "your computer and one of those computers". Utley confirmed that he wanted to purchase his office computer and one of the computers Miller was pointing to.

Miller told me that there was no way that Utley could have confused the Bomber and Nitro for two of the generic computers. First of all, the generic computers were still not boxed and sitting on the desks in the general area of the business. The Bomber and Nitro were already boxed and sitting in the hi-tech room, which is separate from the general office area. Second of all, Utley knows that the Bomber and the Nitro are the two most hi-tech computers in the business. Being President of the Company Utley knew that the computers were worth \$40,000.00. Even if Utley grabbed the wrong computers from the Company he was well aware of what he had when he opened the boxes.

06/29/2001 at 11:30 A.M. Detective Ganci and I drove to Utley's house, which is located at 1930 SW 8th Street in Boca Raton. According to Utley he had possession of the Nitro and the Bomber. Utley told me that he purchased the computers from Ross Miller for \$1,000.00 each. Utley told me that the Nitro and the Bomber were only worth \$1,000.00 each. Utley told me that the software on the Bomber and the Nitro was outdated and no longer worth \$40,000.00. Utley told me that the software on the computer might have been worth \$40,000.00 at one point.

When I asked Utley where the computers were he told me that they were out of the state. Utley then stated, "if the Company gives me \$40,000.00 for the computers I will subtract that from the lawsuit I am filing against them". I told Utley that I would be filing charges against him for grand theft if he did not return the computers to Miller or Kasser. Utley told me that he would speak to his lawyer and then called me with his decision.



Lorraine Christine Hoffman, Esq.
 Assistant Staff Counsel
 The Florida Bar
 File No. 2003-51, 109(15C)

CASE SUPPLEMENTAL REPORT
NOT SUPERVISOR APPROVED

Printed: 02/27/2002 10:35

Boca Raton Police Department

OCA: **2001054580**

THE INFORMATION BELOW IS CONFIDENTIAL - FOR USE BY AUTHORIZED PERSONNEL ONLY

Case Status:	<i>Exceptionally Cleared</i>	Offense:	<i>EMBEZZLEMENT</i>
Case Mng Status:	<i>Exceptionally Cleared</i>	Occured:	<i>04/27/2001</i>

07/02/2001 at 08:30 hours I called Utley's Attorney, Bart Houston, after hearing a message on my answering machine from Houston. Houston told me that Utley agreed to return the Bomber and Nitro to Iviewit.Com. Arrangements were made to have Utley bring the computers to the Police Department and give them to William Kasser on 07/13/2001 at 09:30 hours.

07/02/2001 09:45 hours I advised Kasser to come to the Police Department on 07/13/2001 at 09:30 hours to receive the computers from Utley.

07/13/2001 at 09:30 hours I met Kasser and Utley and at the Police Department for the return of the computers. Kasser handed Utley a check for \$2,000.00 and Utley gave Kasser the Bomber and the Nitro. When Utley returned the computers he did not return the monitors. Utley agreed to send Kasser a check for \$200.00 in the mail for the computer monitors.

Because Utley returned the computers Kasser told me that his Company no longer wanted to press charges against Utley for the theft of the computers. Kasser signed a refusal to prosecute form, which was turned in with the file. Written statements from Kasser and Miller were put into evidence at the Police Department.



Lorraine Christine Hoffman, Esq.
Assistant Staff Counsel
The Florida Bar
File No. 2003-51, 109(15C)

III. Theft of patents – Mr. Wheeler’s management suggestion Mr. Utley is caught writing patents into his own name without assignment to the Company, sent to his home address, and using Iviewit attorney’s William Dick, Doug Boehm and Steven Becker of F&L to complete such patent thefts. It is later discovered that he has tried to take intellectual properties from his last employer with the aid of Mr. Dick, neither fact was disclosed by Mr. Wheeler when recommending such candidates. It is the Companies assertion that Mr. Wheeler intentionally with full knowledge brought past patent thieves in to steal from Iviewit their technologies.

We submit as evidence the following patents that were done by Foley & Lardner (overseen by Mr. William Dick) that were not included in the corporate records and contains knowingly and with malice false information regarding inventor Utley submitted to the US Patent Office, we did not find these patents until Irell & Manella a California law firm designing the licensing agreements for Warner Bros. and Sony amongst others, became nervous of rumors that Mr. Utley and Mr. Dick might have tried to steal patents to Utley. It is also apparent in Mr. Wheeler’s deposition that he claims that Eliot Bernstein made him aware on several instance that people were trying to steal the patents and although he informed the Company that he was investigating such claims, proceeded to instead cover up the matters and take no actions to notify the Board, the investors or any authoritative bodies of such allegations. Dick Bernacchi, Esq. of Irell referred Iviewit to Blakely Sokoloff Zafman and Taylor to conduct an investigation into the patent allegations and when they went to the US Patent Office they found the following patents written into Brian Utley’s home address, with him listed as sole inventor, not assigned to the Company, not in the Corporate records done by Foley & Lardner under the supervision of William Dick:



Lorraine Christine Hoffman, Esq.
Assistant Staff Counsel
The Florida Bar
File No. 2003-51, 109(15C)

Atty. Dis. No. 57103/123

U.S. PROVISIONAL PATENT APPLICATION

for

**ZOOM AND PAN IMAGING
DESIGN TOOL**

Inventors:



Brian G. Utley
1930 SW 8th Street
Boca Raton, FLORIDA 33486
Citizenship: U.S.



FOLEY & LARDNER
Attorneys at Law
777 E. Wisconsin Avenue
Milwaukee, Wisconsin 53202
(414) 271-2400



Lorraine Christine Hoffman, Esq.
 Assistant Staff Counsel
 The Florida Bar
 File No. 2003-51, 109(15C)

VIEWIT.COM PATENT STATUS REPORT

05707

TITLE	MATTER	INVENTOR/ PATENTEE	COUNTRY	SERIAL NO./ PATENT NO.	FILED/ISSUE DATE	ASSIGNEE
<u>Zoom and Pan Imaging Using a Digital Camera</u>	P020 (fka 122)	<u>Brian Utley</u>	United States	Serial No. 60/223,344	Filed 09/18/00	<u>Not assigned.</u>
<u>Zoom and Pan Imaging Design Tool</u>	P021 (fka 123)	<u>Brian Utley</u>	United States	Serial No. 60/233,341	Filed 09/18/00	<u>Not assigned.</u>

Blakely, Sokoloff, Taylor & Zafman

3

The second patent Utley has in his own name with no assignment to the Company is **ZOOM & PAN IMAGING USING A DIGITAL CAMERA**. This summary page was provided to Iviewit's investor Crossbow Ventures by Blakely Sokoloff Zafman and Taylor, and Crossbow then pulled funding on the Company in what appeared to be related to the discovery of such information, investigation pending. As you can see Utley is sole inventor of ideas that were created prior to his employment at iviewit.

Please refer to the footnote in the following document from Blakely Sokoloff Zafman & Taylor after finding such stolen patents and having to try and re-assign them to the Company.



Lorraine Christine Hoffman, Esq.
 Assistant Staff Counsel
 The Florida Bar
 File No. 2003-51, 109(15C)

BLAKELY SOKOLOFF TAYLOR & ZAFMAN LLP

A LIMITED LIABILITY PARTNERSHIP
 INCLUDING LAW CORPORATIONS

TELEPHONE (310) 207-3800

FACSIMILE (310) 820-5988
 (310) 820-5270

BSTZ_MAIL@BSTZ.COM
 WWW.BSTZ.COM

INTELLECTUAL PROPERTY LAW

12400 WILSHIRE BOULEVARD
 SEVENTH FLOOR
 LOS ANGELES, CA 90025-1026

OTHER OFFICES

AUSTIN, TX
 SUNNYVALE, CA
 COSTA MESA, CA
 SAN DIEGO / LA JOLLA, CA
 PORTLAND / LAKE OSWEGO, OR
 SEATTLE / KIRKLAND, WA
 DENVER / ENGLEWOOD, CO

August 4, 2001

**Confirmation
 Copy**

**CONFIDENTIAL COMMUNICATION
 ATTORNEY-CLIENT PRIVILEGED**

VIA E-MAIL
 (And Confirmation By Mail)

Eliot Bernstein
 IVIEWIT.COM, INC.
 505 North Brand Boulevard, Suite 1420
 Glendale, California 91203

Re: Powers of Attorney for Six PCT Applications:

Apparatus and Method for Producing Enhanced Digital Images Serial No. PCT/US00/07772 Our File No. 005707.P009PCT Foley's Reference No. 110	System and Method for Playing a Digital Video File Serial No. PCT/US00/15406 Our File No. 005707.P012PCT Foley's Reference No. 113
System and Method for Streaming an Enhanced Digital Video File Serial No. PCT/US00/15408 Our File No. 005707.P010PCT Foley's Reference No. 111	System and Method for Video Playback Over a Network Serial No. PCT/US00/15602 Our File No. 005707.P016PCT Foley's Reference No. 118
System and Method for Providing an Enhanced Digital Video File Serial No. PCT/US00/15405 Our File No. 005707.P011PCT Foley's Reference No. 112	System and Method for Providing an Enhanced Digital Image File Serial No. PCT/US00/21211 Our File No. 005707.P018PCT Foley's Reference No. 120

Dear Eliot:

Being e-mailed (and enclosed herewith) are six (6) Powers of Attorney for the subject PCT Patent Applications, one Power for each inventor named in any one or more of the PCT patent applications, and one Power for the corporation, Iviewit Holdings, Inc. Three of the Powers require your signature, as follows: (i) one by you in your individual capacity; (ii) a second by you in your capacity as designee of the corporation to sign on behalf of Brian Utley (we hope the PCT Office will recognize Utley's having granted a Power of Attorney to his corporate employer); and (iii) a third by you for the corporation in your capacity as its Secretary. Kindly sign where your





Lorraine Christine Hoffman, Esq.
 Assistant Staff Counsel
 The Florida Bar
 File No. 2003-51, 109(15C)

BLAKELY SOKOLOFF TAYLOR & ZAFMAN LLP

A LIMITED LIABILITY PARTNERSHIP
 INCLUDING LAW CORPORATIONS

Eliot Bernstein
 IVIEWIT.COM, INC.
 August 4, 2001
 Page 2 of 2

signature is indicated on the three Powers of Attorney and return the original executed Powers to our office via mail (we need to have each Power with an original signature). Also fax each Power to us at (310) 820-5988, to expedite the process.

As we discussed, we request that you also forward each of the three remaining Powers to Jude R. Rosario, Jeffrey S. Friedstein and Zakirul A. Shirajee, respectively, for their signatures. Kindly instruct each of them to execute the Powers and to return the originals to our office by mail. In order to expedite the matter, request each of them to fax a copy to us, if possible.

If you have any questions, please feel free to contact my Assistant, Jan Gass. We appreciate your attention to getting the subject Powers executed and returned to us. We will then attend to their filing with the PCT Office.

Best personal regards,

BLAKELY, SOKOLOFF, TAYLOR & ZAFMAN, LLP

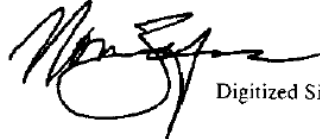

Digitized Signature

Norman Zafman

NZ/jg
 Enclosures

cc: Ross Miller (w/Enclosures via E-Mail) ✓

P.S. to Ross Miller:

Ross, please attend to getting a Board Resolution appointing Eliot as the corporation's designee for signing the subject Power on behalf of Brian Utley. We talked about this in the context of giving Eliot comfort; however, the PCT Office may well request such a Resolution (in addition to a copy of Utley's Employment Agreement, which we already have).

We submit to the Florida Bar the following statements from Mr. Utley's deposition:



Lorraine Christine Hoffman, Esq.
Assistant Staff Counsel
The Florida Bar
File No. 2003-51, 109(15C)

Proskauer Rose vs. Iviewit.com, et al. 8/23/02

THE WITNESS: There was a

266

disagreement as to ownership of the intellectual property.

By MR. SELZ:

Q. There was a dispute?

A. Yes.

Q. Did you ever advise the owner of Diamond Turf that you were going to patent these intellectual properties under your own name?

A. I did.

Q. Did you do that prior to patenting those or after?

A. They were never, they were not patented.

Q. Okay. They were not patented. Was the application for patent made?

A. No.

Q. Since your employment with Iviewit.com or Iviewit, yeah, dotcom, LLC, what patents have you taken out in your name, sir?

A. I have not taken out any patents in my name, other than what has been appended to patents filed by Iviewit and assigned to Iviewit.

Q. Okay. So they're all patents held by Iviewit and you're named as a co-inventor; is

Pat Carl & Associates (763)591-0535 or (800)591-9PCA (722)



Lorraine Christine Hoffman, Esq.
Assistant Staff Counsel
The Florida Bar
File No. 2003-51, 109(15C)

Pruskauer Rose vs. Iviewit.com, et al. 8/23/02

that what it is?

267

A. Yes.

Q. And Iviewit would be listed as a primary patent holder; is that how it would be?

A. They were assigned to Iviewit.

Q. They were assigned to Iviewit. Are you aware of any police report that was ever filed involving Mr. Mike Real and yourself?

MR. PRUSASKI: Objection, relevance.

By MR. SELZ:

Q. Go ahead and answer the question, if you can, sir.

A. There was a dispute over the nature of the equipment that I bought from Iviewit as --

Q. Well, that really wasn't my question. My question was are you aware of a police report? And it's really a yes or no type of answer.

MR. PRUSASKI: Objection, relevance.

THE WITNESS: I believe there was a report.

By MR. SELZ:

Q. Okay. Do you know who filed that report?

A. Iviewit filed that report as far as

at Carl & Associates (763)591-0535 or (800)591-9PCA (722)

And further in Mr. Utley's deposition more perjury:



Lorraine Christine Hoffman, Esq.
Assistant Staff Counsel
The Florida Bar
File No. 2003-51, 109(15C)

Proskauer Rose, et al. vs Iviewit.Com, Inc., et al. 8/22/02

1 picture that would be transmitted across the 114
2 internet at a given speed, I identified that
3 which he had discovered by an ad hoc process; I
4 discovered the structural basis for that
5 optimization.
6 Q. Okay. So that was something that
7 was outside the scope of what he had already,
8 what Eliot had already discovered?
9 A. It really established why it worked.
10 Q. And is your name on any patent or
11 patent application with regard to that particular
12 technology?
13 A. It possibly is. I don't recall how
14 many of those my name is on since I didn't keep
15 any of those records.
16 Q. How about camera zoom applications?
17 A. Okay. How about camera zoom
18 applications?
19 Q. Is there any patent or patent
20 application dealing with camera zoom
21 applications?
22 A. Not specifically. It was, it was
23 determined that there is a correlation between
24 the zoom and pan that had been developed and what
25 is being used in cameras.

Pat Carl & Associates (763)591-0535 or (800)591-9PCA (722)



Lorraine Christine Hoffman, Esq.
Assistant Staff Counsel
The Florida Bar
File No. 2003-51, 109(15C)

Proskauer Rose, et al. vs Iviewit.Com, Inc., et al. 8/22/02

1	Q. Okay. And the correlation was for	115
2	development of future cameras or was that simply	
3	an observation that was made?	
4	A. It was an observation that current	
5	camera technology incorporates zoom and pan	
6	technology.	
7	Q. Okay. How about any patent or	
8	patent applications dealing with scales video or	
9	zoom video imaging applications other than what	
10	we've already discussed?	
11	A. Without looking, and I apologize for	
12	this, without looking at the specific patent	
13	filings by name and number, I think, you know,	
14	we're not really going to be able to get much	
15	further on this discussion.	
16	Q. Okay.	
17	A. I don't want to put you off at all,	
18	but I just want to say that to pursue a detailed	
19	questioning in this specific area, I need to be	
20	able to refresh my mind with what is in the	
21	record.	
22	Q. Okay. And are those documents that	
23	you have in your possession someplace?	
24	A. No.	
25	Q. You don't have any of the paperwork	

Pat Carl & Associates (763)591-0535 or (800)591-9PCA (722)



Lorraine Christine Hoffman, Esq.
 Assistant Staff Counsel
 The Florida Bar
 File No. 2003-51, 109(15C)

And now from Wheeler's deposition where he claims that he is unaware of any camera applications, although many business plans authored, reviewed and billed for by Wheeler make such claims as to the camera applications and in fact at the Real 3D meeting they had stated that it would be one of the most important developments in cameras ever and they were in negotiations with many camera manufacturers that could use it. In addition, Mr. Wheeler is constantly bragging to investors regarding the camera application and suddenly Mr. Wheeler and Mr. Utley both show up at Iviewit one day with a Nikon 990 which is one of the 1st camera's to have such "digital zoom" and tell us that they have both purchased one and have taken pictures of adjoining retirement properties they had just purchased together. Yet in his deposition he feigns ignorance.

We submit from Wheeler's deposition:

3 || Q. Was there ever any representation made
 3 Q. Was there ever any representation made
 4 that you can recall that the technology, to the extent
 5 that it was going to be protected or was in a soon to
 6 be protected form, would be compensated by royalties
 7 almost immediately?
 8 A. No.
 9 Q. Was there any discussion with regard to
 10 any kind of digital camera usage for the technology
 11 that you can recall?
 12 A. Digital camera usage? Not to my
 13 knowledge.
 14 Q. Was there ever anything with a Nikon
 15 camera that was presented at any board meeting or any
 16 meeting with investors?
 17

Now we submit from the Wachovia Private Placement memorandum so authored, billed and disseminated by Mssrs: Wheeler and Utley the following statements:



Lorraine Christine Hoffman, Esq.
Assistant Staff Counsel
The Florida Bar
File No. 2003-51, 109(15C)

***Business
Strategy***



iviewit intends to serve as an end-to-end applications solutions provider incorporating iviewit's proprietary imaging and or video technologies as well as a full-service image and video encoding, hosting and serving provider. iviewit licenses its imaging solutions to B2B and B2C clients in the auction, collectibles, and retail space with subsequent marketing into the healthcare and medical markets. iviewit is also structuring OEM and re-seller relationships to bundle the imaging software and processes with existing hardware including: digital cameras, scanners, and PCs. iviewit is structuring video license agreements with major content and broadband access providers to incorporate the iviewit process into video encoding solutions for direct internet streaming.

iviewit technologies are "process technologies" with pending patents based on efficiency equations, and many of the applications for these technologies are just now being recognized.

WACHOVIA SECURITIES, INC.

Page 4



- Recently, iviewit and Eastman Kodak began a series of discussions that are now formative, and an agreement could provide significant revenue as early as summer 2001. The applications for Kodak would follow a logical path to create a value added option that would initially be available on its "high end" digital cameras, and then be led downstream to the broad and sizeable moderately priced digital camera lines.

WACHOVIA SECURITIES, INC.

Page 6



Lorraine Christine Hoffman, Esq.
Assistant Staff Counsel
The Florida Bar
File No. 2003-51, 109(15C)

CONFIDENTIAL

3. Digital Cameras and Instrumentation

The broadness of iviewit's technologies and its applications outside an Internet based environment depict the scope of the pending patents and their uses in other markets. One such application is in the huge and growing market for digitization, instrumentation, and consumer products such as the digital camera market. Recently, iviewit and Eastman Kodak began a series of discussions that are now formative, and an agreement could provide significant revenue as early as summer 2001.

The applications for Kodak would follow a logical path to create a value added option that would initially be available on its "high end" digital cameras, and then be led downstream to the broad and sizeable moderately priced digital camera lines. In each case the following would be the applications provided to Eastman Kodak for its new and future camera entries:

- The first stage would be the provision of iviewit's imaging technology as a CD that would be included with each camera, so that the consumer when "loading" it on his computer would be able to pan, zoom and "crop" pictures taken from the Kodak digital camera itself. The full iviewit imaging technology would be used on any picture taken, modified and prepared by the user. Currently, the discussions with Kodak include (for high end only) possible inclusion for its Spring 2001 High-end Camera Line (up to 500,000 units). iviewit would prepare the master CD, Kodak would provide the production of same and follow on with the Kodak servicing of this new application for consumers. iviewit would be the "second line" of expertise servicing this application.
- The second stage would be for the development of a software/hardware format that would be fit onto the camera itself during production. iviewit and Kodak would collaborate for this technology application. Concurrently, iviewit and Kodak would broaden the usage to its moderate priced digital camera entries.
- Kodak has requested from iviewit a quote for the above application – first for the high-end market and a licensing opportunity of major significance is underway at this time. Further, other applications of similar nature (both for OEM and reseller purposes) are being developed for the scanner market and the PC market with major companies. In each case, applications driven strategies, value added marketing and cost/performance characteristics are the focus.

The Company has initiated a search for an advertising/new media agency and a public relations agency with demonstrated competence in B2B enabling technologies. The Company currently retains a leading publicist in the entertainment industry. The Company's marketing plan includes the following:

- a national print media campaign targeting corporate decision-makers for encoding images and video for commercial websites,
- a national B2B public relations campaign that targets the streaming media and digital still-imaging markets and that builds awareness and demand for the Company's imaging technologies,
- a trade show plan to promote its video and imaging technologies,
- a plan for the acquisition and exploitation of exclusive internet video events to highlight the Company's technologies and turbo charge its public relations efforts, and partnerships with selected customers for the development of leading edge applications.

The build-out of the sales and marketing team for 2001 is as follows:

- **Inside Sales:** Each of 3 individuals will be focused on generating leads for the Sales Directors in the areas of Entertainment, Education/Distance Learning and E-commerce. The inside sales position will require a minimum of 2 years of sales

And further from Utley's deposition:



Lorraine Christine Hoffman, Esq.
Assistant Staff Counsel
The Florida Bar
File No. 2003-51, 109(15C)

Proskauer Rose, et al. vs Iviewit.Com, Inc., et al. 8/22/02

1 with regard to Iviewit or any of the intellectual 116
2 properties we've already discussed?
3 A. None.
4 Q. Are there any other patents that you
5 hold in your name other than the ones that we've
6 already discussed?
7 A. Yes.
8 Q. What would those be?
9 A. Well --
10 Q. The best of your recollection.
11 Obviously I can't have you guessing but at the
12 same time, if you can recall them, you should be
13 able to provide me with that information?
14 MR. PRUSASKI: Is that question
15 asked as to him personally?
16 MR. SELZ: Yes.
17 MR. PRUSASKI: All right. Let me
18 just interpose an objection as to relevance to
19 that line of questioning.
20 MR. SELZ: Okay.
21 By MR. SELZ:
22 Q. You can go ahead and answer the
23 question.
24 A. Okay. My last formal patent was
25 issued, I believe, in 1997. It was filed by IBM

Pat Carl & Associates (763)591-0535 or (800)591-9PCA (722)



Lorraine Christine Hoffman, Esq.
Assistant Staff Counsel
The Florida Bar
File No. 2003-51, 109(15C)

Proskauer Rose, et al. vs Iviewit.Com, Inc., et al. 8/22/02

1 on, it was a result of some work I did with IBM 117
2 that relates to the ability to digitally
3 recognize writing by a stylus on a surface. You
4 may recognize it in palm devices.
5 Q. Okay. With regard to that, that was
6 obviously prior to your employment with Iviewit;
7 is that correct?
8 A. Yes.
9 Q. Has there ever been any things that
10 you've either sought a patent for or applied for
11 a patent since your employment with Iviewit?
12 A. No.
13 Q. Are you aware of any copyright,
14 trademark or patent applications for either cable
15 system, set top boxes or anything related that
16 are similar to those of the technology that
17 Iviewit owned or made application for?
18 A. No.
19 Q. Do you have any knowledge of any
20 other patent or patent application, intellectual
21 property that might infringe upon patents or
22 applied for patents for Iviewit?
23 A. No. And just to parenthetically
24 state, I have studiously avoided anything which
25 might appear to be or be in any way connected

Pat Carl & Associates (763)591-0535 or (800)591-9PCA (722)



Lorraine Christine Hoffman, Esq.
Assistant Staff Counsel
The Florida Bar
File No. 2003-51, 109(15C)

Proskauer Rose, et al. vs Iviewit.Com, Inc., et al. 8/22/02

1 with that work. 118

2 Q. Have you had any discussions or had
3 any meetings with Mr. Wheeler after your
4 cessation of employment with Iviewit?

5 A. Only of a personal nature.

6 Q. And when was the last time you met
7 with him?

8 A. About three weeks ago?

9 Q. And where was that? Was that here
10 down in south Florida?

11 A. Yes.

12 Q. And what was the purpose for your
13 trip down here?

14 A. Is that, is that -- I have to ask
15 this question, I'm not trying avoid it, but is
16 that anything to do with this interrogatory?

17 Q. Well, it does have to do with the
18 person who introduced you to the company so
19 certainly it's relevant to find out what your
20 relationship is.

21 A. Well, let me just say this, that my
22 visit to Boca Raton had nothing to do with
23 Mr. Wheeler in any event. It was, we got
24 together on a social basis as a circumstantial
25 opportunity based on being there.

Pat Carl & Associates (763)591-0535 or (800)591-9PCA (722)



Lorraine Christine Hoffman, Esq.
Assistant Staff Counsel
The Florida Bar
File No. 2003-51, 109(15C)

And further from Mr. Utley's deposition:



Lorraine Christine Hoffman, Esq.
Assistant Staff Counsel
The Florida Bar
File No. 2003-51, 109(15C)

Proskauer Rose, et al. vs Iviewit.Com, Inc., et al. 8/22/02

1 described in other context? 151
2 A. No.
3 Q. How about with regard to
4 Mr. Wheeler?
5 A. None.
6 Q. How about with regard to Raymond?
7 A. There was some deficiencies in his
8 provisional product descriptions.
9 Q. Okay. How about with regard to
10 Foley & Lardner?
11 A. I'm not aware of any deficiencies of
12 Foley & Lardner.
13 Q. Other than what you -- was that the
14 deficiencies in the sense of the weakness of the
15 descriptions that you described earlier?
16 A. No. No. In fact, Foley & Lardner
17 worked very hard to overcome those and construct
18 the best case possible.
19 Q. How about a situation where they
20 provided patent or patent applications to your
21 home address rather than the corporation's
22 address?
23 A. As a matter convenience in order to
24 obtain signatures.
25 Q. Okay. So you're saying that was

Pat Carl & Associates (763)591-0535 or (800)591-9PCA (722)



Lorraine Christine Hoffman, Esq.
Assistant Staff Counsel
The Florida Bar
File No. 2003-51, 109(15C)

Proskauer Rose, et al. vs Iviewit.Com, Inc., et al. 8/22/02

1 done as a matter of convenience; that wasn't an 152
2 error?

3 A. No. If that happened. I don't
4 recall it happening, but if it did, that would be
5 the only circumstance under which that would
6 happen.

7 Q. Well, but you're speculating because
8 you don't recall the situation?

9 A. I do not recall ever receiving
10 anything at home, but if it happened, it would be
11 as a point of convenience and not as a point of
12 procedure.

13 Q. How about if Foley & Lardner put
14 your home address rather than the corporation's
15 address on a patent application?

16 A. Well, it's normal in a patent
17 application to put the inventor's personal
18 address on the patent application. That's
19 normal.

20 Q. That would be your explanation as to
21 why that would appear on the patent application?

22 A. Absolutely. Every patent ever issue
23 has that. Every patent I've ever had has had my
24 personal address on it, even though it's an IBM
25 patent.

Pat Carl & Associates (763)591-0535 or (800)591-9PCA.(722)



Lorraine Christine Hoffman, Esq.
Assistant Staff Counsel
The Florida Bar
File No. 2003-51, 109(15C)

And from this next part of Utley's deposition we find that Utley had used William Dick in past representation for patents at his prior employer Diamond Turf where patent disputes had occurred leading to Mr. Utley's being fired and the Company forced to close down, this was never represented by Mr. Wheeler or Mr. Utley when they referred Mr. Dick of Foley and Lardner to Iviewit.



Lorraine Christine Hoffman, Esq.
Assistant Staff Counsel
The Florida Bar
File No. 2003-51, 109(15C)

Proskauer Rose vs. Iviewit.com, et al. 8/23/02

we're talking about them because you said billing statements, which could be something totally different, I don't know. 265

MR. SELZ: That's the attached exhibits to the Amended Complaint in this matter that we're referring to.

MR. PRUSASKI: Okay. Thanks.

By MR. SELZ:

Q. Now, you had referenced Mr. Dick doing some patent work for yourself; is that correct?

A. Yes.

Q. And was that any patents arising from your employment with Diamond Turf?

A. It was arising from the technology and engineering work that I did, yes.

Q. So the hydro-mechanical work that you had done at Diamond Turf?

A. Yes.

Q. And was there ever a dispute between yourself and the owner of Diamond Turf with regard to the patents involved for that hydro-mechanical work?

MR. PRUSASKI: Objection, relevance and to the form.

Pat Carl & Associates (763)591-0535 or (800)591-9PCA (722)



Lorraine Christine Hoffman, Esq.
Assistant Staff Counsel
The Florida Bar
File No. 2003-51, 109(15C)

Proskauer Rose vs. Iviewit.com, et al. 8/23/02

THE WITNESS: There was a

266

disagreement as to ownership of the intellectual
property.

By MR. SELZ:

Q. There was a dispute?

A. Yes.

Q. Did you ever advise the owner of
Diamond Turf that you were going to patent these
intellectual properties under your own name?

A. I did.

Q. Did you do that prior to patenting
those or after?

A. They were never, they were not
patented.

Q. Okay. They were not patented. Was
the application for patent made?

A. No.

Q. Since your employment with
Iviewit.com or Iviewit, yeah, dotcom, LLC, what
patents have you taken out in your name, sir?

A. I have not taken out any patents in
my name, other than what has been appended to
patents filed by Iviewit and assigned to Iviewit.

Q. Okay. So they're all patents held
by Iviewit and you're named as a co-inventor; is

Pat Carl & Associates (763)591-0535 or (800)591-9PCA (722)



Lorraine Christine Hoffman, Esq.
Assistant Staff Counsel
The Florida Bar
File No. 2003-51, 109(15C)

Pruskauer Rose vs. Iviewit.com, et al. 8/23/02

that what it is?

267

A. Yes.

Q. And Iviewit would be listed as a primary patent holder; is that how it would be?

A. They were assigned to Iviewit.

Q. They were assigned to Iviewit. Are you aware of any police report that was ever filed involving Mr. Mike Real and yourself?

MR. PRUSASKI: Objection, relevance.

By MR. SELZ:

Q. Go ahead and answer the question, if you can, sir.

A. There was a dispute over the nature of the equipment that I bought from Iviewit as --

Q. Well, that really wasn't my question. My question was are you aware of a police report? And it's really a yes or no type of answer.

MR. PRUSASKI: Objection, relevance.

THE WITNESS: I believe there was a report.

By MR. SELZ:

Q. Okay. Do you know who filed that report?

A. Iviewit filed that report as far as

Pat Carl & Associates (763)591-0535 or (800)591-9PCA (722)



Lorraine Christine Hoffman, Esq.
Assistant Staff Counsel
The Florida Bar
File No. 2003-51, 109(15C)

IV. Misrepresentation of Mr. Utley's background by Mr. Wheeler on a false resume where Utley lies about termination from his prior employer, Monte Friedkin of Diamond Turf, failing to inform the Company that he was involved in patent disputes that led to closure of the Company and his being fired. More shocking is that Utley testifies that Wheeler was "fully cognizant" of such termination and reasons surrounding such termination.

From the response filed by Mr. Wheeler we quote:

B. Misrepresentations: Mr. Bernstein alleges that Mr. Wheeler misrepresented: (i) Brian Utley's background while recommending him for a position with Iviewit; (ii) patent attorney William Dick's background; (iii) that Raymond Joao was a Proskauer attorney; and (iii) that Kenneth

C. Conflicts of Interest: Mr. Bernstein alleges that Proskauer: (i) represented other clients with a conflict of interest to Iviewit; (ii) failed to disclose the prior representation of Brian Utley; and

IV. No Misrepresentations Were Made To Eliot Bernstein

In his complaint, Mr. Bernstein alleges that Mr. Wheeler somehow misrepresented the credentials of several people to Iviewit, most notably Brian Utley, Iviewit's former President and COO. According to Mr. Bernstein, Mr. Wheeler misrepresented the background of Mr. Utley in order to induce Iviewit to hire him.

It is worth noting that, at the time of his hiring as the President of Iviewit, Mr. Utley was retired from a **thirty-seven year career with IBM**, serving as the Vice-President and General Manager in charge of the Boca Raton, Florida operations. Contrary to Mr. Bernstein's allegations, Mr. Wheeler merely introduced Mr. Utley to Simon Bernstein and advised him that he first met Mr. Utley in 1990 on a social level and subsequently served with him on the Florida Philharmonic and Florida Atlantic University Foundation Boards. (Deposition of Christopher Wheeler ("Wheeler dep.") at 113-18, 131-20). The introduction was made because Simon Bernstein was looking for someone to run Iviewit and asked Mr. Wheeler for a recommendation. Mr. Wheeler disclosed his social relationship with Mr. Utley to Simon Bernstein and told him that Mr. Utley was the site manager of IBM's Boca Raton office when they first met in 1990. *Id.* at 115-12, 117-1. Mr. Wheeler advised Mr. Bernstein to explore with Mr. Utley whether he was a good fit for Iviewit. *Id.* at 115-12. At no point did Mr. Wheeler submit any "false resumes" on behalf of Mr. Utley and he is unaware of the existence of any such document. ←

We respectfully submit Mr. Utley's resume as given to Iviewit by Mr. Wheeler for circulation to approve Mr. Utley to the Board and Investors and a confirmation email that Mr. Wheeler was in receipt of Mr. Utley's resume. Further in every business plan that was authored, reviewed, billed for by Proskauer Rose and disseminated by Mr. Wheeler to investors, potential investors, clients, shareholders, potential clients and Wachovia Securities for a Private Placement of 12-20M, Mr. Utley's background was included, with false statements. We ask that the Florida Bar contact Mr. Monte Friedkin ((954) 972-3222 x310) for testimony that Mr. Utley's statements are false in regard to his past employment. When contacted by Iviewit after Mr. Utley's termination we got a far different story on what happened at Diamond Turf Lawnmower, which is that Mr. Utley had attempted to steal patents which led to his being fired and the Company being closed. Since Mr. Wheeler, Mr. Utley and Mr. Friedkin all sat on the FAU Board together, Mr. Friedkin was confident that Wheeler had full knowledge of the situation, but more telling is that in Mr. Utley's deposition



Lorraine Christine Hoffman, Esq.
 Assistant Staff Counsel
 The Florida Bar
 File No. 2003-51, 109(15C)

he claims that Mr. Wheeler was fully “cognizant” of the reasons surrounding his departure. Mr. Wheeler in his deposition is unclear of his knowledge and in the letter submitted to the Bar of Florida he is in complete denial.

1930 SW 8th Street
 Boca Raton, FL 33486

Personal Resume

Professional History:

President, Diamond Turf Equipment, Inc. July, 1995 to July 1999.

In 1995 the company was engaged in refurbishing obsolete and run-out golf course maintenance equipment and had annual sales of \$250K. Since that time the company has been transformed into a manufacturer of new machines which compete favorably with the best of the market leaders and an expected revenue for 1999 of \$6M. The design of the machines was by Brian and was accomplished while putting together a manufacturing and marketing team capable of supporting the rapid growth of the company.

Truth was per Monte Friedkin that Utley was that he was fired for patent theft and Company was shut down!

Wheeler sets up Premier no COI, Utley lies in depo saying Wheeler never did work for him. Wheeler depo says he did it and did not disclose this to Company, lies to Bar of Florida and says he did????

President, Premier Connections, Inc., November, 1991 to present.

Premier Connections provides consultation and support services in computer and related business management. Customers have included IBM and other small businesses.

IBM, October, 1955 to October, 1991.

Brian retired from IBM as Vice-President and General Manager, IBM Boca Raton.

Prior to his assignment in Boca Raton Brian spent 5 years in Europe as Group Director for PC's and small systems. This responsibility covered all aspects of product management for all European, Middle East and African countries.

In 1983 Brian was appointed General Manager, IBM Biomedical Systems and asked by the IBM President, John Opel, to evaluate develop the long range strategy for this business unit. Brian subsequently reported back to the President that the Business Unit, while quite viable, should be sold to a related business in the medical community. Having received approval to do so, he negotiated a profitable sale for IBM.

Between 1965 and 1983 Brian was the project and systems manager for many major IBM computer systems which earned IBM billions of dollars in revenue. The most notable of these was the S/38 and AS400, one of IBM's most technology aggressive development programs ever and still one off IBM's most popular systems.

Brian entered the IBM laboratories in 1959 and immediately became the most prominent engineer on his first project with many innovative designs. As a result of this he was assigned to the German IBM laboratories to train German engineers in computer technology. He has been awarded a number of patents the most recent of which was granted in 1998.

From his start in October 1955 to the time he entered the laboratories Brian was a customer engineer responsible for maintaining IBM equipment on customer premises. During this time he self taught computer technology and transistor theory and developed the first IBM field course in transistors. This is the accomplishment which led to his assignment in the laboratories.

No formal engineering degree ever obtained.

Education:

Having been born in England, he attended Beverley Grammar School and graduated in 1948 at 16. In 1949 he emigrated to the United States and completed his senior year at Ogden High School, Ogden, Utah.

He attended college at Weber College, Ogden, Utah and San Francisco City College completing two years of study.

Wachovia PPM says he was graduate, in his own deposition he says he was not!!

Hobbies:

Brian is a jogger and for 40 years has been an avid glider pilot with many competitive successes.

Wachovia PPM says he was graduate, in his own deposition he says he was not!!



Lorraine Christine Hoffman, Esq.
Assistant Staff Counsel
The Florida Bar
File No. 2003-51, 109(15C)

And from Utley's deposition you will find quite a different story of what led to his being fired from Diamond Turf and the closure of the business:



Lorraine Christine Hoffman, Esq.
Assistant Staff Counsel
The Florida Bar
File No. 2003-51, 109(15C)

Proskauer Rose, et al. vs Iviewit.Com, Inc., et al. 8/22/02

Q. What's that?

101

A. Beg Pardon?

Q. What was that address, sir?

A. That was 1930 Southwest Eighth Street.

Q. Okay. And how long did you operate Premier Consulting?

A. I'm still doing it.

Q. Still doing it; it's still active, okay. Are there any other employees of Premier Consulting other than yourself?

A. No.

Q. Have there ever been any other employees of Premier Consulting other than yourself?

A. No.

Q. Have you ever had any work or did any work for a company called Diamond Turf Lawn Mower?

A. I did.

Q. When was that?

A. That was about 1995 until mid 99.

Q. Were you actually employed by Diamond Turf Lawn Mower?

A. Yes.

Pat Carl & Associates (763)591-0535 or (800)591-9PCA (722)



Lorraine Christine Hoffman, Esq.
Assistant Staff Counsel
The Florida Bar
File No. 2003-51, 109(15C)

Proskauer Rose, et al. vs Iviewit.Com, Inc., et al. 8/22/02

Q. Okay. You just failed to mention 102
that in your previous --

A. I'm sorry, yes.

Q. Okay. And what did you do at
Diamond Turf Lawn Mower?

A. I was president.

Q. You were president. For the full
four years?

A. Yes.

Q. Okay.

A. My recollection is a little hazy.
It could have been 95, 96 when I started.

Q. Okay. So you were president of this
company for approximately three to four years?

A. Yes.

Q. And what was your role at Diamond
Turf Lawn Mower as president; what did you do?

A. I ran the company.

Q. Did you take on the position not
only of president but also as CFO or anything of
that nature, or you just did strictly like a
chief operating officer; what was your role
exactly?

A. I suppose you could consider it to
be a cross between a chief operating officer and

Pat Carl & Associates (763)591-0535 or (800)591-9PCA (722)



Lorraine Christine Hoffman, Esq.
Assistant Staff Counsel
The Florida Bar
File No. 2003-51, 109(15C)

Proskauer Rose, et al. vs Iviewit.Com, Inc., et al. 8/22/02

the chief engineer.

103

Q. And what did Diamond Turf Law Mower do; what sort of company is that?

A. It produced maintenance equipment for golf courses.

Q. Okay. And were you working also doing engineering for the company as well?

A. Yes.

Q. And that engineering capabilities that you have, was that something you garnered through your employment with IBM or is that something that you had specific knowledge of outside of your employment with IBM?

A. Both.

Q. This was not engineering of electrical components; this was engineering of mechanical systems; is that what this was?

A. Every, virtually every mechanical system has an electrical component.

Q. Okay.

A. And a hydraulic component in this particular case.

→ Q. And when did you -- when you ceased worked with Diamond Turf Lawn Mower, was that an amicable leaving or was there some problem or did

Pat Carl & Associates (763)591-0535 or (800)591-9PCA (722)



Lorraine Christine Hoffman, Esq.
Assistant Staff Counsel
The Florida Bar
File No. 2003-51, 109(15C)

Proskauer Rose, et al. vs Iviewit.Com, Inc., et al. 8/22/02

1 everything work out okay with that?

104

2 A. Well, there was a, there was a
3 dispute over intellectual property. There was no
4 intellectual property agreement in my employment
5 agreement and there were certain inventions that
6 I made that we were unable to resolve ownership
7 of.

8 Q. Okay. So these were inventions that
9 you developed while you were employed by Diamond
10 Turf Lawn Mower?

11 A. Yes.

12 Q. Okay. Can you describe those
13 inventions to me.

14 A. They related to hydro-mechanical
15 equipment.

16 Q. Okay. What exactly with hydraulic
17 mechanical equipment?

18 A. How much detail you want me to go in
19 to?

20 Q. Well, were they related somehow to
21 the operations of the hydraulics of the equipment
22 or were they strictly mechanical?

23 A. They related to a hydro-mechanical
24 system, which means that it involves the
25 integration of hydraulics into a mechanically

Pat Carl & Associates (763)591-0535 or (800)591-9PCA (722)



Lorraine Christine Hoffman, Esq.
Assistant Staff Counsel
The Florida Bar
File No. 2003-51, 109(15C)

Now we submit from a private placement memorandum submitted to Wachovia Securities authored by Mr. Utley and reviewed and billed for by Mr. Wheeler and other representatives of Proskauer Rose, as stated in his deposition testimony, a biography of Mr. Utley that completely states false and misleading statements that he has graduated college, which clearly is refuted by his own deposition testimony where he clearly states he did NOT graduate college and contradicts his resume statements.



Lorraine Christine Hoffman, Esq.
Assistant Staff Counsel
The Florida Bar
File No. 2003-51, 109(15C)

Confidential Private Placement Memorandum Number: V19

Offeree: _____

CONFIDENTIAL PRIVATE PLACEMENT MEMORANDUM



\$12 MILLION PREFERRED STOCK

December 2000

WACHOVIA SECURITIES, INC.

WACHOVIA



Lorraine Christine Hoffman, Esq.
 Assistant Staff Counsel
 The Florida Bar
 File No. 2003-51, 109(15C)



CONFIDENTIAL

Management

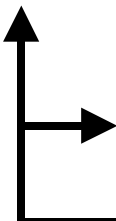

Whereas the Company has retained Korn / Ferry to assist in the identification and recruitment of a high impact Chief Executive Officer (preferably from the media or entertainment industry) and Chief Technical Officer, iviewit has assembled a complementary and seasoned, management team with Fortune 100 and early-stage, entrepreneurial experience. This team consists of the following personnel:

Brian G. Utley, President (67) — For over 30 years, Mr. Utley was responsible for the development and world-wide management of many of IBM's most successful products such as the AS400 and the PC. His career with IBM culminated with his responsibility as Vice President and General Manager of IBM Boca Raton with a work force of over 6,000 professionals. He is a graduate of San Francisco City College.

Eliot I. Bernstein, Founder and Vice Chairman (37) — Prior to founding iviewit, Mr. Bernstein spent 15 years with SB Lexington where he was President of the West Coast Division creating and developing many innovative, computer-based multi-media marketing tools which remain in use supporting multi-billion dollar service industries. Mr. Bernstein is a graduate of the University of Wisconsin.

Michael A. Reale, Vice President of Operations (60) — Mr. Reale has over 20 years of operations experience, including P&L, quality, and delivery performance accountability. Most recently, Mr. Reale was the Chief Operating Officer for Boca Research (Nasdaq:BOCI), a manufacturer of personal computer enhancement and Internet thin client products. Mr. Reale received his BA and MBA from Pace University.

Raymond T. Hersh, Vice President of Finance (58) — Mr. Hersh has over 35 years of successful business and operating experience involving financial services, telecommunications, manufacturing, and corporate strategic planning. For over 20 years, Mr. Hersh has operated and grown companies in Florida, and most recently, he was co-founder and President/CEO of New Medical Concepts, Inc., a telecom company specializing in providing healthcare information. Earlier, he spent five years as an Enforcement Attorney with the U. S. Securities and Exchange Commission in New York City where he exited as a Branch Chief. He is a member of the New Jersey and New York Bars. Mr. Hersh received his BA from Lafayette College and his LLB/JD from the University of Pennsylvania.

Kevin J. Lockwood, Vice President of Sales and Business Development (40) — Mr. Lockwood joins iviewit from Cylex Systems where he held the position of Executive Vice President of Sales and assisted in securing three rounds of funding exceeding \$20 million. He also held the position of Head of Sales for Acer America, Inc. where he increased sales from a run rate of \$150 million annually to over \$1.5 billion annually in only a 17-month time. In addition, Mr. Lockwood successfully launched the Fujitsu P.C. into the U.S. and in the first year amassed revenues of over \$200 million. He is a graduate of the University of Maryland with a Bachelor of Science degree in Business Administration.

Guy Iantoni, Vice President of Sales (35) — Prior to joining iviewit in 1999, Mr. Iantoni was Senior Financial Representative with Fidelity Investments. From 1995 to 1997, he served as an Investment Management Consultant to the private client group of Morgan Stanley Dean Witter & Company, Inc. Mr. Iantoni has developed computer databases and systems to effectively market and target segments in both the financial markets and the healthcare industries. Mr. Iantoni is a graduate of the University of Wisconsin with an advanced degree in Pharmacy.

Strategic Alliances

iviewit is creating a stable of strategic partners in the areas of technology, R&D, applications development, and video hosting and delivery. The Company has partnered with key industry leaders to develop precedence in the market. Partners include Greg Manning Auctions, Atlas Entertainment, Medical Online, Digital Island, Burst.com, and Versifi.



Lorraine Christine Hoffman, Esq.
Assistant Staff Counsel
The Florida Bar
File No. 2003-51, 109(15C)

And from Mr. Utley's resume as submitted to the Board and Investors by Mr. Wheeler and upon acceptance of Mr. Utley distributed widely including to Mr. Wheeler himself who claims in his deposition and to the Florida Bar that he was unaware of Utley's misrepresentation of his employment at Diamond Turf:

office when they first met in 1990. *Id.* at 115-12, 117-1. Mr. Wheeler advised Mr. Bernstein to explore with Mr. Utley whether he was a good fit for Iviewit. *Id.* at 115-12. At no point did Mr. Wheeler submit any "false resumes" on behalf of Mr. Utley and he is unaware of the existence of any such document.



Lorraine Christine Hoffman, Esq.
Assistant Staff Counsel
The Florida Bar
File No. 2003-51, 109(15C)

-----Original Message-----

From: iviewit, inc. (E-mail) [mailto:iviewmaster@iviewit.com]
Sent: Thursday, August 05, 1999 9:03 PM
To: Alan Epstein (E-mail); Michele M. Mulrooney (E-mail); James F. Armstrong (E-mail); Simon L. Bernstein (E-mail); Patti & Lester Daniels (E-mail); Andrew L. Dietz (E-mail); Donna Dietz (E-mail); Gerald R. Lewin (E-mail); Guy Iantoni (E-mail); James R. Jackoway (E-mail); James A. Osterling (E-mail); Albert W. Gortz (E-mail); Christopher C. Wheeler (E-mail); Jude Rosario (E-mail); Jude Rosario (E-mail 2); Zakirul Shirajee (E-mail); Friedstein, Jeff; Donald G. Kane II (E-mail); Brian G. Utley (E-mail 2)
Subject: iviewit.com Welcomes Brian Utley.

Dear Shareholders,

As of August 3rd, 1999 the Board of Directors of iviewit.com has approved and confirmed Brian Utley as President and COO. Mr. Utley will assume leadership of the company and the responsibility for organizing our strategic initiatives and licensing opportunities. Brian brings over thirty years of management experience from IBM and is highly respected within the computer industry. We are fortunate to bring Brian to iviewit.com and look forward to his valuable contribution to the success of the company.

Brian can be reached at utley_b@bellsouth.net
mailto:utley_b@bellsouth.net or soon at utley@iviewit.com
<<mailto:utley@iviewit.com>>.

By phone at work through Goldstein & Lewin at 561-994-5050 or cell at 561-289-8145.

Brian's Personal Resume

Professional History:

President, Diamond Turf Equipment, Inc. July, 1995 to July 1999.

In 1995 the company was engaged in refurbishing obsolete and run-out golf course maintenance equipment and had annual sales of \$250,000. Since that time the company has been transformed into a manufacturer of new machines that compete favorably with the best of the market leaders and expected revenue for 1999 of \$6M. The design of the machines was by Brian and was accomplished while putting together a manufacturing and marketing team capable of supporting the rapid growth of the company.

President, Premier Connections Inc., November, 1991 to Present.
Premier Connections provides consultation and support services in computer and related business management. Customers have included IBM and other small businesses.

IBM, 1955 to 1991.
Brian retired from IBM as Vice-President and General Manager, IBM Boca Raton.

Prior to his assignment in Boca Raton Brian spent 5 years in Europe as Group Director for PC's and small Systems. This responsibility covered all aspects of product management for all European, Middle East and African countries.



Lorraine Christine Hoffman, Esq.
Assistant Staff Counsel
The Florida Bar
File No. 2003-51, 109(15C)

In 1983 Brian was appointed General Manager, IBM Biomedical Systems and asked by the IBM President, John Opel, to evaluate develop the long range strategy for this business unit. Brian subsequently reported to the President that the Business Unit, while quite viable, should be sold to a related business in the medical community. Having received approval to do so, he negotiated a profitable sale for IBM.

Between 1965 and 1983 Brian was the project and Systems manager for many major IBM computer Systems that earned IBM billions of dollars in revenue. The most notable of these was the 5E3E and AS400, one of IBM's most technology aggressive development programs ever and still one off IBM's most popular systems.

Brian entered the IBM laboratories in 1959 and immediately became the most prominent engineer on his first project with many innovative designs. Because of this, he was assigned to the German IBM laboratories to train German engineers in computer technology. He has been awarded a number of patents the most recent of which was granted in 1998.

From his start in October 1955 to the time he entered the laboratories Brian was a customer engineer responsible for maintaining IBM equipment on customer premises. During this time he self-taught computer technology and transistor theory and developed the first IBM field course in transistors. This is the accomplishment, which led to his assignment in the laboratories.



Sincerely,

Board of Directors
iviewit.com



Lorraine Christine Hoffman, Esq.
Assistant Staff Counsel
The Florida Bar
File No. 2003-51, 109(15C)

We respectfully submit the following deposition testimony from Utley, which shows that contrary to the sworn statement for the Wachovia business plan, authored by Utley and approved by Wheeler for Proskauer Rose whom billed for such review, that Mr. Utley in fact never graduated college or has a professional engineering degree:



Lorraine Christine Hoffman, Esq.
Assistant Staff Counsel
The Florida Bar
File No. 2003-51, 109(15C)

Proskauer Rose, et al. vs Iviewit.Com, Inc., et al. 8/22/02

or where the site of that lawsuit was? 94

A. No.

Q. Was it in the federal court or state court?

A. I don't know.

Q. Was your deposition taken in the State of Florida --

A. No.

Q. -- or taken elsewhere?

A. It was taken in New York.

Q. In New York. Okay. Now, going back to something that Mr. Prusaski started but I don't think he completed with was some of your background information about your education. If you can just tell me from undergraduate onward what your educational background is, Sir, schools you attended, years of attendance and degree.

A. I don't have a degree.

Q. Okay.

A. I attended Weaver State University, which was then Weaver College, 1950.

Q. Okay.

A. San Francisco City College, 1957, 1958.

Q. Okay. And you graduated from San

Pat Carl & Associates (763)591-0535 or (800)591-9PCA (722)



Lorraine Christine Hoffman, Esq.
Assistant Staff Counsel
The Florida Bar
File No. 2003-51, 109(15C)

Proskauer Rose, et al. vs Iviewit.Com, Inc., et al. 8/22/02

Francisco College or did not?

95

A. I don't have a degree.

Q. Okay. So you never completed your course at San Francisco then?

A. Right.

Q. With regard to your employment experience, you had stated your employment with IBM. What years was that from, Sir?

A. 1955 through 1992.

Q. 92. And your first employment with IBM in 1955, what position was that in if you can recall?

A. I was employed as a customer engineer.

Q. All right. And after that, you were promoted to what position?

A. In 1960 I was promoted to development engineer, electrical engineer.

Q. At that point, were you supervising a staff or working with other engineers below you at that point?

A. I was involved in design of a computer.

Q. Were you the leader of any design team or were you just an individual engineer

at Carl & Associates (763)591-0535 or (800)591-9PCA (722)



Lorraine Christine Hoffman, Esq.
Assistant Staff Counsel
The Florida Bar
File No. 2003-51, 109(15C)

And now from Mr. Wheeler's deposition he denies that he knew why Utley was fired from Diamond Turf over patent disputes which Utley claims Wheeler was fully aware of such situation, one of them has perjured themselves. It is further interesting to note that Wheeler again feigns confusion when he knows the owner of Diamond Turf well and sits on the Board of Florida Atlantic University with him and Mr. Utley.



Lorraine Christine Hoffman, Esq.
Assistant Staff Counsel
The Florida Bar
File No. 2003-51, 109(15C)

117

1 A. Uh-huh. He was the site manager, or the
2 equivalent of the title.

3 Q. And when you introduced him to Sy and
4 Eliot Bernstein, do you know what he was doing at that
5 point in time?

6 A. He was working at a - and running a - a -
7 what could we call it, a company that was
8 manufacturing - developing and manufacturing greens
9 cutting equipment. It's called Diamond Turf, I think.
10 Or something like that.

11 Q. Do you know if he was terminated from his
12 job at Diamond Turf or did he leave voluntarily?

13 A. I don't know which.

14 Q. At the time that he took the job with
15 iviewit, do you know if he was gainfully employed at
16 that point or not?

17 A. No. I don't know if he was still employed
18 by Diamond Turf or not.

19 Q. Did you ever see Mr. Utley's resume?

20 A. I don't recall if he was -- Did I ever see
21 his resume? Not to my recollection.

22 Q. Did he ever provide you with any
23 background information?

24 A. He could have, but I don't recall it.

25 Q. C.V. or anything of that nature to give to

KEN SCHANZER & ASSOCIATES, INC. (954) 922-2660



Lorraine Christine Hoffman, Esq.
Assistant Staff Counsel
The Florida Bar
File No. 2003-51, 109(15C)

1 the Bernsteins?

2 A. I don't recall.

3 Q. Are you aware of any patents that
4 Mr. Utley holds?

5 A. No. No, I'm not.

6 Q. Have you ever -- I'm sorry, go ahead.

7 A. I'm not aware of anything other than if he
8 referenced patents in his own deposition, but I
9 didn't - I didn't follow that closely in his
10 deposition.

11 Q. So you - you read a transcript of his
12 deposition?

13 A. Yes.

14 Q. Now, with regard to his - I'll take
15 Mr. Utley's employment by iviewit, have you ever
16 represented Mr. Utley personally in any matters?

17 A. We formed a corporation for him in - I
18 believe in 1993.

19 Q. Do you recall the entity, the corporation?

20 A. I think it was a consulting corporation.
21 We just formed it. I mean, we just formed it. That's
22 all we did.

23 Q. Right.

24 A. We didn't do any more work for him.

25 Q. Just formed the consulting corporation?

KEN SCHANZER & ASSOCIATES, INC. (954) 922-2660



Lorraine Christine Hoffman, Esq.
Assistant Staff Counsel
The Florida Bar
File No. 2003-51, 109(15C)

We respectfully submit the following evidence from Mr. Utley's deposition whereby he claims that Mr. Wheeler was fully cognizant of his being fired and the circumstances surrounding them from Diamond Turf:



Lorraine Christine Hoffman, Esq.
Assistant Staff Counsel
The Florida Bar
File No. 2003-51, 109(15C)

Skauer Rose vs. Iviewit.com, et al. 8/23/02

president and COO of Iviewit to Wachovia?

243

A. We shared nondisclosure agreements and communicated as required in order to construct the business plan.

Q. And did they require or request that you provide them with a CV as part of the business plan to evidence your expertise.

A. I believe so.

MR. PRUSASKI: Objection to form.

MR. SELZ: I'll restate the question.

By MR. SELZ:

Q. Did Wachovia Bank request that you provide personal information to them as part of that business plan?

A. Yes.

Q. And did you provide that personal information in the form of a curriculum vitae or CV?

A. It was integrated in prior editions of the business plan and flowed into the one that was developed with Wachovia.

Q. Now, when Chris Wheeler first introduced you to Iviewit, was he aware of the situation at Diamond Turf and yourself and

Carl & Associates (763)591-0535 or (800)591-9PCA (722)



Lorraine Christine Hoffman, Esq.
Assistant Staff Counsel
The Florida Bar
File No. 2003-51, 109(15C)

Pruskauer Rose vs. Iviewit.com, et al. 8/23/02

Mr. Monte Freedkin or what was Mr. Wheeler's 244

knowledge of your position at Diamond Turf, to
the best of your knowledge?

MR. PRUSASKI: Objection to form.

MR. SELZ: Okay. I'll restate the
question. I'm sorry. Getting a little tired.

MR. PRUSASKI: I'm just objecting to
the extent that you're asking him what Chris
Wheeler's personal knowledge was.

MR. SELZ: Okay.

By MR. SELZ:

Q. To the extent that you know, what
was Chris Wheeler's personal knowledge of that
situation?

MR. PRUSASKI: Objection to form.

→ THE WITNESS: I believe Chris,
Mr. Wheeler was fully cognizant of my
relationship to Diamond Turf Equipment and to
Mr. Freedkin.

By MR. SELZ:

→ Q. And he was aware about your
departure from that company and that situation?

A. Yes.

Q. Involving your employed and your
change of employment when you left Diamond Turf?

Carl & Associates (763)591-0535 or (800)591-9PCA (722)



Lorraine Christine Hoffman, Esq.
Assistant Staff Counsel
The Florida Bar
File No. 2003-51, 109(15C)

Woskauer Rose vs. Iviewit.com, et al. 8/23/02

A. Yes.

245

Q. Other than your retirement at IBM, was there any other reason why you left IBM's employ?

A. No.

Q. Do you have any ongoing dispute with either IBM or Diamond Turf?

A. No.

Q. Going back to the employment of an attorney when you were at Diamond Turf, was there a retainer agreement that you recall signing on behalf of Diamond Turf to employ an attorney there? Or I'll take that back. I think you said that you never employed an attorney there; is that correct?

A. That is correct.

Q. When you hired an attorney personally, did you have a retainer agreement that you signed?

A. No.

Q. Do you have any letter or any other document evidencing the rates to be charged and the services to provided by that attorney?

A. I would have to research that question.

Carl & Associates (763)591-0535 or (800)591-9PCA (722)

And from Mr. Wheeler's sworn deposition statement a quite different story is told:



Lorraine Christine Hoffman, Esq.
Assistant Staff Counsel
The Florida Bar
File No. 2003-51, 109(15C)

120

1 MR. TRIGGS: Object to form.

2 Q. Did Proskauer assist Mr. Utley in
3 prosecuting any patents or having any other
4 intellectual properties protected by copyright or
5 trademark?

6 A. No.

7 Q. Are you aware of any claims by Diamond
8 Turf that Mr. Utley improperly received intellectual
9 properties or patented them that belonged to Diamond
10 Turf?

11 A. Aware that --

12 Q. Mr. Utley is alleged to have improperly
13 received or taken intellectual properties of Diamond
14 Turf.

15 A. By Diamond Turf? No.

16 Q. Okay. On the amended complaint --

17 MR. SELZ: Let's get this marked.

18 (Thereupon, said document was marked as
19 Defendant's Exhibit Number 3 for identification
20 by the reporter.)

21 Q. All right, sir. We had an earlier
22 discussion regarding the original complaint filed in
23 this action. You now have before you what's been
24 marked as Defendant's Exhibit Number 3, which is
25 docket entry number nine in the court file. It's the

KEN SCHANZER & ASSOCIATES, INC. (954) 922-2660



Lorraine Christine Hoffman, Esq.
Assistant Staff Counsel
The Florida Bar
File No. 2003-51, 109(15C)

If Mr. Wheeler knew of Mr. Utley's being fired and the reasons surrounding his departure, then it logically follows that he knew Mr. William Dick was involved in the malfeasances that occurred when he and Mr. Utley then recommended Mr. William Dick to replace Mr. Joao to handle patents for Iviewit. Had these past circumstances been properly represented to Iviewit by Mr. Wheeler, Mr. Utley or Mr. Dick than it is most certain that we would have never hired any of the three of them for positions that involved anything to do with patents or management.

Now that the Bar of Florida can see many of the events that led to the employment of Utley and the true and correct reasons for Mr. Utley and Mr. Wheeler's actions against the Company, we submit the following chart to help understand the people whom they introduced the Company too, many in conflict of interest and violation of NDA's and all having tentacles to Mr. Wheeler.



Lorraine Christine Hoffman, Esq.
 Assistant Staff Counsel
 The Florida Bar
 File No. 2003-51, 109(15C)

Flow Chart of Conspirators, Potential Conspirators and Infringers
 Conspirators and infringers under NDA highlighted in blue, all with tentacles to Wheeler and Gerald Lewin. All others involved have not been deposed for statements regarding their involvement yet.

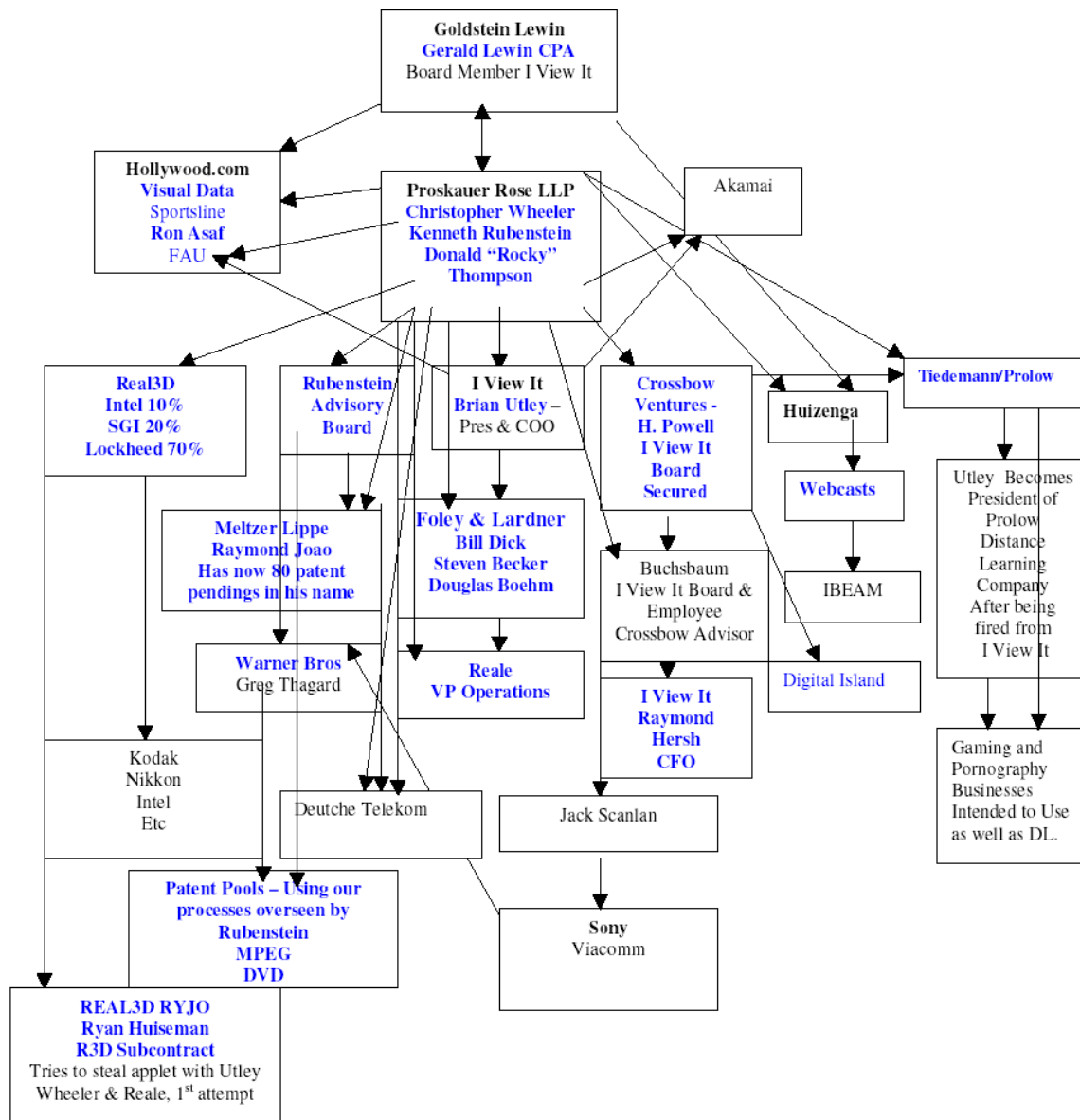

V. Conflicts of interest in representing Mr. Utley to Iviewit and failure to disclose to the Company that a conflict existed between Mr. Utley being represented by Mr. Wheeler and Proskauer Rose in the past and not disclosing such information upon referral of Mr. Utley. Mr. Wheeler had



Lorraine Christine Hoffman, Esq.
Assistant Staff Counsel
The Florida Bar
File No. 2003-51, 109(15C)

started a computer consulting business (Premier Consulting Inc.) that is still in existence and had conflicting clients, i.e. IBM, that was not properly disclosed to Iviewit. Mr. Wheeler's deposition testimony will contradict his statements to the Bar of Florida and represents yet another perjured statement.

IV. No Misrepresentations Were Made To Eliot Bernstein

In his complaint, Mr. Bernstein alleges that Mr. Wheeler somehow misrepresented the credentials of several people to Iviewit, most notably Brian Utley, Iviewit's former President and COO. According to Mr. Bernstein, Mr. Wheeler misrepresented the background of Mr. Utley in order to induce Iviewit to hire him.

C. **Conflicts of Interest:** Mr. Bernstein alleges that Proskauer: (i) represented other clients with a conflict of interest to Iviewit; (ii) failed to disclose the prior representation of Brian Utley; and

V. No Conflicts Of Interest Existed In Proskauer's Representation Of Iviewit

Mr. Bernstein also alleges the existence of a conflict of interest on the part of Mr. Wheeler based on → his prior representation of Mr. Utley in other matters. At the time Mr. Wheeler introduced Mr. Utley to Mr. Bernstein, Mr. Wheeler disclosed that Proskauer had previously formed a corporation for Mr. Utley in approximately 1993. At the time the introduction was made, Mr. Utley was not a current client of the firm. In short, there was no conflict of interest arising out of Mr. Wheeler merely

And this next part of Mr. Wheeler's deposition is in direct contradiction to his statements to the Floirda Bar in this matter, in that he has claimed to the bar that he notified Iviewit of his involvement with Mr. Utley on a professional basis and in his deposition testimony contrarily denies such, thus constituting perjury.



Lorraine Christine Hoffman, Esq.
Assistant Staff Counsel
The Florida Bar
File No. 2003-51, 109(15C)

118

1 the Bernsteins?

2 A. I don't recall.

3 Q. Are you aware of any patents that
4 Mr. Utley holds?

5 A. No. No, I'm not.

6 Q. Have you ever -- I'm sorry, go ahead.

7 A. I'm not aware of anything other than if he
8 referenced patents in his own deposition, but I
9 didn't - I didn't follow that closely in his
10 deposition.

11 Q. So you - you read a transcript of his
12 deposition?

13 A. Yes.

14 Q. Now, with regard to his - I'll take
15 Mr. Utley's employment by iviewit, have you ever
16 represented Mr. Utley personally in any matters?

17 A. We formed a corporation for him in - I
18 believe in 1993.

19 Q. Do you recall the entity, the corporation?

20 A. I think it was a consulting corporation.
21 We just formed it. I mean, we just formed it. That's
22 all we did.

23 Q. Right.

24 A. We didn't do any more work for him.

25 Q. Just formed the consulting corporation?

KEN SCHANZER & ASSOCIATES, INC. (954) 922-2660



Lorraine Christine Hoffman, Esq.
Assistant Staff Counsel
The Florida Bar
File No. 2003-51, 109(15C)

119

1 A. Right.

2 Q. Did you ever advise anyone at iviewit
3 other than, obviously, Mr. Utley, who knew that you
4 had represented him in the past, that you had
5 represented Mr. Utley at one point?

6 A. No.

7 Q. Was there any - any question of any
8 conflict?

9 A. No.

10 Q. Was there any employment agreement signed
11 by Mr. Utley between Mr. Utley and iviewit?

12 A. Yes.

13 Q. And who prepared the employment agreement?

14 A. Proskauer.

15 Q. And did you not think that potentially
16 posed a conflict?

17 A. No.

18 Q. And who did you represent in the
19 preparation of that employment agreement?

20 A. The company. We did not represent
21 Mr. Utley.

22 Q. So there was no waiver of conflict, no
23 conflict letter, nothing went out with regard to
24 Mr. Utley and iviewit?

25 A. No.

KEN SCHANZER & ASSOCIATES, INC. (954) 922-2660

Mr. Wheeler has committed perjury in his deposition or lied to the Florida Bar.



Lorraine Christine Hoffman, Esq.
Assistant Staff Counsel
The Florida Bar
File No. 2003-51, 109(15C)

And further evidence from Mr. Utley's deposition as contrasted to Mr. Wheeler's will further show they both commit perjury. From Utley's deposition we submit deposition in which he clearly perjures himself in that Wheeler in the previous testimony says that he did represent Utley:



Lorraine Christine Hoffman, Esq.
Assistant Staff Counsel
The Florida Bar
File No. 2003-51, 109(15C)

Proskauer Rose, et al. vs Iviewit.Com, Inc., et al. 8/22/02

1 least nine years before you were introduced to 108

Iviewit then?

A. Yes.

Q. Did you keep up any communications with him or talk to him on a regular basis?

A. Well, we had a mutual friend, as it turned out, and we were involved in local philanthropic activities together, so we, yes, we had fairly frequent contact.

Q. Okay. Could you say, then, that you developed a friendship of sorts with Mr. Wheeler?

A. Yes.

Q. Other than socially and through your immediate contact through IBM, did you know Mr. Wheeler in any other setting?

A. No.

Q. No other business dealings, no other representation by yourself of Mr. Wheeler, nothing of that sort?

A. Well, I don't know how you want to classify being on the same board. We were both on the philharmonic board. We were both involved with Community Hospital. I recruited him to Florida Atlantic University Foundation Board, which I chaired.

Pat Carl & Associates (763)591-0535 or (800)591-9PCA (722)



Lorraine Christine Hoffman, Esq.
Assistant Staff Counsel
The Florida Bar
File No. 2003-51, 109(15C)

Proskauer Rose, et al. vs Iviewit.Com, Inc., et al. 8/22/02

1 Q. Okay. Other than that, he never 109
2 represented you as an attorney; he never
3 represented you in any case, nothing of that
4 sort?
5 A. No.
6 Q. Now, when Mr. Wheeler first
7 introduced you to Iviewit, did he specify, other
8 than what we've already discussed, the purpose
9 for his introduction? Did he talk to anything
10 about a scope of employment or what your purpose
11 would be at the company, other than what you've
12 already described?
13 A. No. He said he was looking for
14 someone with a technology background who had the
15 potential to run the company.
16 Q. Now, with regard to Eliot Bernstein,
17 Jude Resario and Zakirul Shirajee, am I
18 pronouncing that correctly?
19 A. Why don't you spell it.
20 Q. Let's see, I got Z-A-K-I-R-U-L, last
21 name is S-H-I-R-A-J-E-E. Do you remember meeting
22 with those gentlemen, Eliot Bernstein and Jude
23 Resario and Zakirul Shirajee?
24 A. At a later point in time, yes.
25 Q. Okay. What was the time that you

Pat Carl & Associates (763)591-0535 or (800)591-9PCA (722)



Lorraine Christine Hoffman, Esq.
Assistant Staff Counsel
The Florida Bar
File No. 2003-51, 109(15C)

VI. Proskauer Rose as patent counsel for Iviewit and supporting evidence of such Intellectual Property representation contrary to Rubenstein, Wheeler and Utley statements under deposition and clearly in opposition to claims to the Florida Bar by the Respondent.

We submit the following as quoted to the Florida Bar in defense of Mr. Wheeler and evidence in direct contradiction to these Bar statements and his deposition statements:

A. Patent Work: Mr. Bernstein alleges that Proskauer mishandled certain patent work. To the contrary, as we show below (see Section III), there is overwhelming testimonial and documentary evidence showing that **Proskauer simply never performed patent work for Iviewit.**

Iviewit's patent work was handled entirely by other law firms. Whether there were any errors or omissions with the patent work is immaterial. Proskauer simply did not perform that work.

Foley & Lardner. This is confirmed by the depositions taken during the course of the Litigation, including that of Iviewit's former President and COO, Brian Utley, who testified that "Rubenstein and Mr. Wheeler, I'll repeat, had nothing to do with the patents. . . ." (Deposition of Brian Utley ("Utley Dep.") at 150-9).

When asked to opine as to the veracity of an interrogatory answer submitted by Mr. Bernstein during the course of the Litigation which suggested that Proskauer played a role with respect to Iviewit's patent work, Mr. Utley was unequivocal in his response:

Q. The answer to [Eliot Bernstein's] Interrogatory 20 in Subparagraph Roman Numeral XI, 11, it says: "Chris Wheeler agreed to investigate charges that Rubenstein and the name J-O-A-O, which I think is Joao. . . . [w]ere forging and changing patent documents and leaving inventors off patents. Wheeler and Utley suggest using their friend William D-I-C-K, and then it looks like it's cut off, Foley & Lardner to correct the gross negligence uncovered in Rubenstein/Joao work."

How do you respond to that statement?

A. Well, Rubenstein was never involved in any of that work.

Q. Is that a misrepresentation?

A. That's a misrepresentation.

Q. Were there any charges by you or anyone at Iviewit that Joao was forging and changing patent documents and leaving inventors off patents?

A. No.



Lorraine Christine Hoffman, Esq.
Assistant Staff Counsel
The Florida Bar
File No. 2003-51, 109(15C)

Kenneth Rubenstein, who was also deposed in connection with the Litigation, could not have been clearer as to the scope of Proskauer's representation:

- Q. Did you ever opine with regard to the validity of any patent applied for or received by Iviewit.com?
- A. Like I say, I was not in any way involved with getting patents for Iviewit.
- Q. What were you involved with, if you were, with Iviewit?
- A. The only thing I did for Iviewit is I referred them to another patent lawyer.
- Q. And who is that?
- A. A guy named Ray Joao.
- Q. And where did Mr. Joao work?
- A. I believe he was working at the time at my former law firm, Meltzer Lippe.

(Deposition of Kenneth Rubenstein ("Rubenstein dep.") at 23-4).

We now submit the following letter to the Board written by Mr. Utley that will refute Utley's own statements that he did not use Rubenstein as an advisor. In this next document authored by Mr. Utley and sent to Mr. Wheeler he clearly states that he consulted with Kenneth Rubenstein and Proskauer Rose as patent advisors before disseminating highly confidential patent materials to almost every contact of Iviewit's at Warner Bros. leading to problems that ended the Iviewit/Warner Bros. account. Further compounding the Warner Bros. problem that resulted from such transmission of patent documents is a major conflict of interest, in that when asked to opine to the Warner Bros. representatives regarding the patent documents sent by Utley, Mr. Rubenstein refused to address questions regarding his prior statements to Warner Bros. representatives regarding the Iviewit technologies, claiming a "conflict of interest". Finally a Conflict of Interest existed as Mr. Rubenstein also oversees the patent pool for DVD as lead counsel and Mr. Gregory Thagard of Warner Bros. (another advisory board member of Iviewit) who Rubenstein consulted with on behalf of Iviewit for Warner Bros. and who holds many of DVD's essential patents. This patent pool that both are a part of and now benefits from Iviewit technologies and their relationship and thus this conflict was never disclosed to the Company as Mr. Rubenstein opined for Iviewit to Warner Bros. several times. Mr. Rubenstein deposition poses serious perjured statements as will be evidenced later in this rebuttal.



Lorraine Christine Hoffman, Esq.
 Assistant Staff Counsel
 The Florida Bar
 File No. 2003-51, 109(15C)

Eliot I. Bernstein

Subject: FW: Minutes of the Board Meeting of April 14, 2001

-----Original Message-----

From: Brian G. Utley [mailto:brian@iviewit.com]
Sent: Wednesday, April 18, 2001 11:17 AM
To: Eliot I. Bernstein; 'simon@adelphia.net'; 'kanderson@myCFO.com'; 'dg_kane@msn.com'; 'glewin@goldsteinlewin.com'; 'hankpow@gate.net'; 'bprolow@tiedemannfunds.com'; Maurice Buchsbaum
Cc: 'Christopher C. Wheeler (E-mail)'
Subject: RE: Minutes of the Board Meeting of April 14, 2001

I was advised by Proskauer Rose that anyone who was in an active due diligence stage and who was reviewing our intellectual property as part of that due diligence should receive a copy of the examiners opinion. Therefore the opinion was forwarded to the same people who have received copies of the patent filings namely, Warner Brothers and Irell & Manella. Ken Rubenstein, as our advisor, was also copied. Your father suggested that, because of the importance of our intellectual property, our own Board of Directors should be aware of the current status of our applications. With respect to Irell & Manella, it is quite likely that we will need to engage them or some other alternative counsel in order to respond to the opinion. I have a copy of Alvear's book if you need it.

With respect to processing the requested demo tape, you may recall that you actually set the standard by processing similar demo material for igallery some time ago. This job was handled discreetly and the 18 year old employee referred to had already been released from the business. We are not in the business of processing adult entertainment material and have consistently represented this position. I trust this clarifies both matters.
 Brian

-----Original Message-----

From: Eliot I. Bernstein
Sent: Tuesday, April 17, 2001 7:07 PM
To: 'simon@adelphia.net'; 'kanderson@myCFO.com'; 'dg_kane@msn.com'; 'glewin@goldsteinlewin.com'; 'hankpow@gate.net'; 'bprolow@tiedemannfunds.com'; Maurice Buchsbaum
Cc: Brian G. Utley; Christopher C. Wheeler (E-mail)
Subject: RE: Minutes of the Board Meeting of April 14, 2001

Brian - several board members asked that you specify which of our attorneys advised you and on what legal references you were cited to disseminate the PCT report. Also, was there some reason that you have recently decided to share patent news of any nature with those involved, prior you had never disclosed to the Board or potential clients anything that was regarding the patents?

I had already discussed with David the examiners report and we had begun to research the reference to Jose Alveraz's book, it does not look particularly relevant to our process.

Also, I find it in poor taste that you are encoding pornography with a 17 year old girl present in the room, this could potentially be a risk to the company, so I ask that all further business relating to pornography be handled outside the office and without iVIEWIT personnel or equipment. Could you please have our attorney's advise on the risks you may be subjecting us to in this matter. These matters were brought to my attention by several of our employees who were offended.

Best,
 Eliot

-----Original Message-----

From: Bonnie M Barwick
Sent: Tuesday, April 17, 2001 5:18 PM
To: 'simon@adelphia.net'; Eliot I. Bernstein; 'kanderson@myCFO.com'; 'dg_kane@msn.com'; 'glewin@goldsteinlewin.com'; 'hankpow@gate.net'; 'bprolow@tiedemannfunds.com'; Maurice Buchsbaum

4/15/2003



Lorraine Christine Hoffman, Esq.
Assistant Staff Counsel
The Florida Bar
File No. 2003-51, 109(15C)

Page 2 of 2

Cc: Brian G. Utley
Subject: Minutes of the Board Meeting of April 14, 2001



www.iviewit.com

Dear Sirs,

As requested by Brian Utley please find attached a copy of the Minutes of the iviewit Holdings Inc. Board of Directors meeting of April 14, 2001. A hard copy of these minutes as well as a copy of the Patent Cooperation Treaty numbers PCT/US00/15405 and PCT/US00/15406 will follow by mail.

Bonnie M. Barwick

Office Manager/Executive Assistant
2255 Glades Road
One Boca Place-Suite 337W
Boca Raton, Florida 33431
Voice: 561-999-8899 extn. 302
Fax: 561-999-8810
Toll Free: 877-484-8444
email: bonnie@iviewit.com

4/15/2003



Lorraine Christine Hoffman, Esq.
Assistant Staff Counsel
The Florida Bar
File No. 2003-51, 109(15C)

From Mr. Utley's deposition we quote:



Lorraine Christine Hoffman, Esq.
Assistant Staff Counsel
The Florida Bar
File No. 2003-51, 109(15C)

Proskauer Rose, et al. vs Iviewit.Com, Inc., et al. 8/22/02

1 was doing work, Mr. Rubenstein was doing work" for 121

2 Iviewit?

3 A. I'm not aware -- other than
4 referring Iviewit to Meltzer, Rubenstein never
5 did any work for Iviewit.

6 Q. Okay. So Rubenstein's sole role,
7 from what you understand, is he referred Iviewit
8 to the Meltzer Law Firm in New York?

9 A. Yes.

10 Q. Was he ever part of an advisory
11 board member or was he an advisory board member
12 to Iviewit? And we're talking about
13 Mr. Rubenstein.

14 A. I have never used him as an advisory
15 board member?

16 Q. Are you aware of whether or not he
17 ever attended any board meetings with the
18 directors of Iviewit?

19 A. He never attended a board meeting.
20 I've never met the man.

21 Q. In regard to meetings with Proskauer
22 Rose, did you have any meetings with Proskauer
23 Rose concerning their retainer by Iviewit?

24 A. Only in the final weeks of Iviewit's
25 presence in Boca Raton.

Pat Carl & Associates (763)591-0535 or (800)591-9PCA (722)



Lorraine Christine Hoffman, Esq.
Assistant Staff Counsel
The Florida Bar
File No. 2003-51, 109(15C)

Further deposition testimony from Utley:



Lorraine Christine Hoffman, Esq.
Assistant Staff Counsel
The Florida Bar
File No. 2003-51, 109(15C)

Proskauer Rose, et al. vs Iviewit.Com, Inc., et al. 8/22/02

1 engagement agreement refers to the parent company 138
2 of Iviewit.

3 Q. Well, let's go to my next question
4 on this whole thing, and that is, with regard to,
5 with regard to the approval by the board of
6 directors, we've talked prior about the board of
7 directors and Ken Rubenstein, was Ken
8 Rubenstein -- you've previously stated that he
9 didn't have any role with regard to the company,
10 no active role?

11 A. That's correct.

12 Q. And I hate to bounce back and forth
13 to you about this, he was never, like, an advisor
14 or consultant or anything like that; he was just
15 someone who was Proskauer Rose's person who did
16 work on IP?

17 A. Yeah, I can't speak to the
18 discussions that may have taken place between
19 Mr. Wheeler and Mr. Rubenstein, but --

20 Q. I'm not asking you to. I'm just
21 saying from what you know because obviously this
22 deposition testimony is given on your own
23 personal knowledge.

24 A. Yes. He played no active role in
25 the company other than having directed the

Pat Carl & Associates (763)591-0535 or (800)591-9PCA.(722)



Lorraine Christine Hoffman, Esq.
Assistant Staff Counsel
The Florida Bar
File No. 2003-51, 109(15C)

Proskauer Rose, et al. vs Iviewit.Com, Inc., et al. 8/22/02

1 company to work with Meltzer and this gentleman 139
2 Rolf as the patent attorney.
3 Q. And that was his totality of his
4 role from what you know?
5 A. Yes.
6 Now, let me parenthetically add,
7 that I do understand and know that it was Eliot's
8 desire to see him involved in an advisory role.
9 Q. Okay.
10 A. But that was never, that was never
11 consummated.
12 Q. Okay. Did you ever want him to act
13 in an advisory role?
14 A. I did not take any position on that.
15 Q. Okay. Did you ever represent that
16 he should be in an advisory role?
17 A. No.
18 Q. Okay. So you really didn't have any
19 opinion on what Mr. Rubenstein should or should
20 not be doing with Iviewit?
21 A. Right.
22 Q. Okay. Did you have any discussions
23 or correspondence at all with Rubenstein and
24 Raymond Joao, I think it is? Is that how you
25 pronounce it, J-O-A-O?

Pat Carl & Associates (763)591-0535 or (800)591-9PCA (722)



Lorraine Christine Hoffman, Esq.
Assistant Staff Counsel
The Florida Bar
File No. 2003-51, 109(15C)

And finally after referring to Mr. Utley in the Board letter as an advisor in his own words and saying he had contacted him regarding a major decision to send patent documents to Warner Brothers we find this statement in Utley's deposition:



Lorraine Christine Hoffman, Esq.
Assistant Staff Counsel
The Florida Bar
File No. 2003-51, 109(15C)

Proskauer Rose, et al. vs Iviewit.Com, Inc., et al. 8/22/02

1 A. Did I have any discussion with him 140
2 about the patent attorney? Not about the patent
3 attorney, no.
4 Q. Okay. With regard to Iviewit
5 patents, how about with regard to Iviewit
6 patents?
7 A. I do recall that I've had at least
8 one conversation with Ken Rubenstein.
9 Q. Okay. How about with Raymond?
10 A. I had a number of conversations with
11 Raymond.
12 Q. How do you pronounce his last name?
13 A. Frankly, I don't remember. It's
14 been such a long time.
15 MR. PRUSASKI: Joao.
16 By MR. SELZ:
17 Q. How about Joao; is that it?
18 A. Something like that.
19 Q. Okay. Yeah.
20 A. It's a Portuguese name.
21 Q. Right.
22 MR. PRUSASKI: It's Joao.
23 THE WITNESS: But, like I say, I do
24 recall that I had one conversation with Ken
25 Rubenstein, but I absolutely do not recall the

Pat Carl & Associates (763)591-0535 or (800)591-9PCA (722)



Lorraine Christine Hoffman, Esq.
Assistant Staff Counsel
The Florida Bar
File No. 2003-51, 109(15C)

Proskauer Rose, et al. vs Iviewit.Com, Inc., et al. 8/22/02

1 content of the conversation. It was not anything 141

2 that was material to what Iviewit did.

3 By MR. SELZ:

4 Q. How about were there any -- did you
5 keep any notes of any of your meetings with these
6 people at all?

7 A. Any of my notes are in the company
8 files.

9 Q. And where are the company files, to
10 the last of your recollection, now?

11 A. They were all sent to California.

12 Q. All sent to California. To who out
13 in California, if you know?

14 A. Ross Miller was responsible for
15 doing that so I think that question should be
16 directed towards him.

17 Q. And so Ross Miller was the person
18 who, according to your knowledge, had the custody
19 of the corporate documents last?

20 A. Yes.

21 Q. Now, you'd said at one time in your
22 earlier testimony that Proskauer was to act as
23 corporate custodian of some kind. Did you mean
24 custodian of records or custodian of the
25 corporate books or custodian of some other

Pat Carl & Associates (763)591-0535 or (800)591-9PCA (722)



Lorraine Christine Hoffman, Esq.
Assistant Staff Counsel
The Florida Bar
File No. 2003-51, 109(15C)

From Utley's Outlook file we find his notes on arranging for a call between Greg Thagard of Warner Brothers and Ken Rubenstein, the comments with mcm are from Brian G. Utley's secretary Martha Mantecon.

Eliot I. Bernstein

Subject: Warner Brothers - Greg and Ken Rubenstein need to talk
Due Date: Monday, October 16, 2000
Priority: High
Status: In Progress
Percent Complete: 0%
Total Work: 0 hours
Actual Work: 0 hours
Owner: Eliot I. Bernstein
Company: Warner Brothers
adminFolderName: Administration
NoAdminErrorMessage: The application can not find your team folder's administration folder
TaskOwner: Brian G. Utley
WelcomeMessageTitle: WelcomeForm_Admin

10.11.00 Per EIB tlak with David - Ken and Greg are phone tag. Brian has scheduled a conference call with Ken and Chris and then will be contacting Greg. Also, he will arrange Bill Dick conversation

10.17.00 mcm Brian left a message for Ken Rubenstein and is waiting for his call.

Further from another internal status with the bgu being Brian G. Utley:

Eliot I Bernstein

Subject: Warner Brothers - Waiting for Ken & Greg to speak. Ken has LM to CB
Start Date: Tuesday, October 10, 2000
Due Date: Monday, October 16, 2000
Priority: High
Status: Waiting on someone else
Percent Complete: 0%
Total Work: 0 hours
Actual Work: 0 hours
Owner: Eliot I. Bernstein
Company: Warner Brothers

11.10.00 eib Call David to get forward progress

10.16.00 bgu Ken Rubenstein has been brought up to speed and is waiting for Greg's call. Greg's office has been called, he has not called back. Then we will get Dages.

10.16.00 eib David and I will be meeting Friday, it would be good to have some answer by then. We can schedule Dages if all is complete with Ken & Greg



Lorraine Christine Hoffman, Esq.
 Assistant Staff Counsel
 The Florida Bar
 File No. 2003-51, 109(15C)

VII. Proskauer says they did not do patent work at all for Iviewit and we submit this excerpt from their response to the Florida Bar and the following evidence to refute this claim.

III. Proskauer Did Not Perform Patent Work For Iviewit

Mr. Bernstein's bar complaint is replete with allegations concerning alleged improper patent work. Both Proskauer attorneys and corporate representatives of Iviewit have confirmed under oath that there is no truth to any of these assertions. Rather, Iviewit's patent work was performed by Raymond Joao, who at the time was employed by Meltzer Lippe, and thereafter by William Dick of Foley & Lardner. This is confirmed by the depositions taken during the course of the Litigation, including that of Iviewit's former President and COO, Brian Utley, who testified that "Rubenstein and Mr. Wheeler, I'll repeat, had nothing to do with the patents. . . ." (Deposition of Brian Utley ("Utley Dep.") at 150-9).

We submit the following statement from Mr. Wheeler's deposition:

7	Q. Did you ever have a discussion with	
8	Mr. Bernstein about Proskauer Rose providing an	
9	opinion with regard to the patentability of any of	
10	these processes?	
11	A. No.	

We respectfully submit the following letter in direct contradiction to all statements that Proskauer did not do ANY patent work, among hosts of other evidence, authored on PR letterhead and penned by Mr. Wheeler himself. The document is in direct contradiction to all statements to the Bar in denial of patent work and opinions of the patents by Proskauer Rose. In no way does Mr. Wheeler refer to outside counsel when opining but refers to "we" as being Proskauer Rose. Mr. Rosman was acting on behalf of Hassan Miah who had asked for Ken Rubenstein's opinion as Iviewit's advisor. The document stands in the face of almost all statements made by Wheeler/Rubenstein in regards to their self proclaimed role as overseers of the Iviewit patents. The patent counsel he was advised by was Mr. Rubenstein. He states that they (Proskauer Rose) have undertaken both corporate and intellectual property matters, although he and Kenneth Rubenstein deny this vehemently throughout their depositions and throughout Mr. Wheeler's claims to the Florida Bar.

Finally, it should be noted that Proskauer's invoices also confirm that Proskauer did not perform patent work. Rather, Proskauer's role was limited to referring the patent work to other law firms. Thus, regardless of whether Mr. Bernstein is pleased or displeased with the patent-related services provided to Iviewit, Proskauer simply did not provide those services. In short, Mr. Bernstein's accusations that Proskauer somehow performed patent work at all, much less performed patent work improperly, is demonstrably false.



Lorraine Christine Hoffman, Esq.
Assistant Staff Counsel
The Florida Bar
File No. 2003-51, 109(15C)



Christopher C. Wheeler
Member of the Firm

Direct Dial 561.995.4702
cwheeler@proskauer.com

April 26, 1999

Mr. Richard Rossman
Lewinter and Rossman
16255 Ventura Blvd., Suite 600
Encino, CA 91436

Re: iviewit, Inc.

Dear Richard:

Under separate cover I have forwarded you a revised Confidentiality Agreement.

As you know  we have undertaken representation of iviewit, Inc. ("iviewit") and are helping them coordinate their corporate and intellectual property matters. In that regard, we have reviewed their technology and procured patent counsel for them. We believe the iviewit technology is far superior to anything presently available with which we are familiar. Iviewit has filed a provisional patent application on a method for providing enhanced digital images on telecommunications networks. We are advised by patent counsel that the process appears novel and may be protected by the patent laws. While in all matters of this sort, it is far to early to make any final pronouncements, we do believe that there is an extremely good prospect that iviewit will protect their process which is novel and superior to any other format which we have seen.

Very truly yours,

Christopher C. Wheeler

CCW/gb

0894/40017-001 BRLIB/227137 v1

04/22/99 03:57 PM (2743)

And another signed copy to an investor and to Armstrong Hirsh Jackoway Tyerman & Wertheimer partner Alan Epstein, Esq. a shareholder and legal counsel for Ivewit at the time.



Lorraine Christine Hoffman, Esq.
Assistant Staff Counsel
The Florida Bar
File No. 2003-51, 109(15C)

JUN 10 1999 11:37 FR PROSKAUER ROSE

561 241 5280 TO 4174470R

P.02/06

PROSKAUER ROSE LLP

2255 Glades Road
Suite 340 West
Boca Raton, FL 33431-7300
Telephone 561.241.7400
Elsewhere in Florida
800.432.7746
Fax 561.241.7145

NEW YORK
LOS ANGELES
WASHINGTON
NEWARK
PARIS

Christopher C. Wheeler
Member of the Firm
Direct Dial 561.995.4702
cwheeler@proskauer.com

June 9, 1999

Via Fax

Mr. Gemal Seede
Nercubator
30 W. Green Street
Pasadena, CA 91105

Dear Mr. Seede:

At the request of Alan Epstein, I am forwarding the enclosed two Confidentiality Agreements to you. I would appreciate your signing and returning them to me.

We have undertaken representation of iviewit, Inc. ("iviewit") and are helping them coordinate their corporate and intellectual property matters. In that regard, we have reviewed their technology and procured patent counsel for them. We believe the iviewit technology is far superior to anything presently available with which we are familiar. iviewit has filed a provisional patent application on a method for providing enhanced digital images on telecommunications networks. We are advised by patent counsel that the process appears novel and may be protected by the patent laws. While in all matters of this sort, it is far too early to make any final pronouncements. We do believe that there is an extremely good prospect that iviewit will protect their process which is novel and superior to any other format which we have seen.

Sincerely,

Christopher C. Wheeler

CCW/gb

cc: Alan J. Epstein - Via Fax

0894/40017-001 BRLIB1/232305 v1

06/09/99 06:52 PM (2743)



Lorraine Christine Hoffman, Esq.
Assistant Staff Counsel
The Florida Bar
File No. 2003-51, 109(15C)

And then from Mr. Wheeler's deposition testimony addressing his knowledge of this letter we have submitted:

11 Q. Do you have any idea what this 4/26/99
12 entry is, 1.0, rewrite iviewit letter?
13 A. I don't know which one that is.
14 Q. 4/26/99?
15 A. No, I see the entry, but I don't know
16 which letter that was.
17 Q. Now, you said you did transactional work.
18 Do you also do any intellectual properties work at
19 all?
20 A. No.
21 Q. Were you involved with reviewing the
22 trademark or any of those other things?
23 A. No. ←

Later from Mr. Wheeler's deposition

200
1 Company Certificate as Exhibit to opinion, et cetera,
2 et cetera. There were more - I would imagine they
3 were corporate matters. We wouldn't have opined - we
4 never opined to the intellectual property.

Regarding statements that Mr. Rubenstein only referred Iviewit to Mr. Joao we find the following message from Mr. Wheeler regarding a patent meeting that he has invited Ken Rubenstein to attend.



Lorraine Christine Hoffman, Esq.
Assistant Staff Counsel
The Florida Bar
File No. 2003-51, 109(15C)

Eliot I Bernstein

From: Eliot I. Bernstein [res0bf4a@verizon.net]
Sent: Monday, July 09, 2001 3:38 PM
To: H. Hickman "Hank" Powell (E-mail); H. Hickman "Hank" Powell (E-mail 2)
Subject: FW: Tuesday Meeting

-----Original Message-----
From: Christopher Wheeler [mailto:CWHEELER@proskauer.com]
Sent: Friday, May 28, 1999 6:26 AM
To: alps@netline.net
Subject: Tuesday Meeting

**** High Priority ****

Eliot,

Ken Rubenstein will be available on Tuesday morning sometime between 8:30 and 9 to discuss the patents. We can conference him in after we start with Joao and ourselves. Have you already made sure that Joao will be available? Please advise immediately.

Best regards,

Chris

Further from his deposition he claims complete ignorance to the technologies he had written such a lavish opinion on.



Lorraine Christine Hoffman, Esq.
Assistant Staff Counsel
The Florida Bar
File No. 2003-51, 109(15C)

39

1 that portal that you can recall?

2 A. You mean at this stage?

3 Q. Or at any point now. What he's referring
4 to.

5 A. It had been described to me as his imaging
6 were large images versus small images.

7 Q. Okay. And what was unique about that?

8 MR. TRIGGS: Object to the form.

9 A. It was what was available on the Internet.
10 It was represented to me that what was available on
11 the Internet at that time was small pictures and they
12 couldn't be enlarged without pixilation.

13 Q. And what is pixilation?

14 MR. TRIGGS: Object to form.

15 A. Well, I'm not an expert on this. So I
16 mean, you should ask an expert. But I was told,
17 pixilation was some form of distortion.

18 Q. So it's your understanding that pixilation
19 is that when an image is enlarged, it distorts?

20 A. Correct.

21 Q. And this process, I'm going to use the
22 words that you used, the process that Mr. Bernstein
23 had presented --

24 A. Right.

25 Q. -- somehow avoided this problem?

KEN SCHANZER & ASSOCIATES, INC. (954) 922-2660



Lorraine Christine Hoffman, Esq.
Assistant Staff Counsel
The Florida Bar
File No. 2003-51, 109(15C)

40

1 A. Right. Purportedly it avoided the
2 problem.

3 Q. Was it demonstrated to you at any point in
4 time?

5 A. Not at that time.

6 Q. How about subsequently?

7 A. Oh, absolutely.

8 Q. Okay. And did the process, as
9 demonstrated, do what it purported to do?

10 A. I saw large pictures on a screen which
11 were pixilated which were not distorted.

12 Q. Which were not distorted. And they had
13 been enlarged from a small picture or a small --

14 A. I don't know what they had been enlarged
15 from.

16 MR. TRIGGS: And, Steve, I'm not going to
17 shut down your line of examination because to do
18 that I'd need to terminate the deposition, but
19 quite frankly, I can't see the relevance at all
20 on this line of inquiry.

21 MR. SELZ: That's fine.

22 MR. TRIGGS: I mean, all I'm telling you
23 is, at some point I will have to terminate the
24 deposition and file an appropriate motion if we
25 continue to hit on areas that just appear to be

KEN SCHANZER & ASSOCIATES, INC. (954) 922-2660



Lorraine Christine Hoffman, Esq.
Assistant Staff Counsel
The Florida Bar
File No. 2003-51, 109(15C)

41

1 doing nothing more than harassing at this point.

2 MR. SELZ: Well, with all due respect to
3 your objection, obviously, speaking objections
4 aren't appropriate, certainly in a deposition,
5 but with regard to that, I think it's actually
6 something that's referenced in Mr. Wheeler's own
7 letter.

8 So I think I certainly have an ability to
9 inquire as to what this process was that he was
10 referencing.

11 MR. TRIGGS: You're wasting time, is what
12 you're doing.

13 MR. SELZ: Well, you're certainly entitled
14 to your opinion.

15 Q. Okay. Now, with regard to this image, was

16 there something also, pan and zoom, or something of
17 that nature, that was demonstrated to you?

18 A. I'm not familiar with that.

19 Q. How about something called -- I'm sorry.

20 A. It wasn't demonstrated at all at this
21 stage.

22 Q. I'm talking about at any time during your
23 representation of iviewit?

24 A. Okay. I'm not familiar with the terms,
25 pan and zoom.

KEN SCHANZER & ASSOCIATES, INC. (954) 922-2660



Lorraine Christine Hoffman, Esq.
Assistant Staff Counsel
The Florida Bar
File No. 2003-51, 109(15C)

42

1 Q. How about - how about full-screen video?

2 MR. TRIGGS: Object to form. What about
3 full screen video?

4 Q. Are you familiar with the term?

5 A. Not in any technical sense.

6 Q. Okay. It isn't in your opinion or your
7 knowledge any way related to the process that
8 Mr. Bernstein was involved with?

9 MR. TRIGGS: Object to the form,
10 foundation.

11 A. The process was larger pictures than
12 available on - presently available on the Internet, as
13 I understood it.

14 Q. So it was basically an enlargement of a
15 picture without pixilation. That was your
16 understanding of the process.

17 A. Right.

18 Q. That you referred to in your letter.

19 A. Correct.

20 Q. Was there any other technology that you
21 were aware of that iviewit had developed?

22 A. No.

23 Q. Were there any specific applications that
24 were discussed between iviewit and yourself in the
25 sense of the purpose of these corporations?

KEN SCHANZER & ASSOCIATES, INC. (954) 922-2660



Lorraine Christine Hoffman, Esq.
Assistant Staff Counsel
The Florida Bar
File No. 2003-51, 109(15C)

43

1 MR. TRIGGS: Object to the form.

2 Q. Let me rephrase it. Were there any
3 specific applications that were discussed with you as
4 to this technology?

5 MR. TRIGGS: Object to the form. At what
6 point in time?

7 Q. During your representation of iviewit.

8 A. Yes. During our representation, there
9 were suggestions that it could be used in various
10 industries or in - in - that - various industries
11 could take advantage of it.

12 Q. Okay. And when was the first time that
13 was discussed?

14 A. I don't recall.

15 Q. Was it prior to the signed retainer
16 agreement, prior to July?

17 A. Yes, it was prior to the signed retainer
18 agreement.

19 Q. Was it -- It was after the first meeting
20 is what you're saying.

21 A. Oh, yes.

22 Q. Okay.

23 A. Well, I don't recall -- Yes, it was
24 probab -- I don't know if it was at -- Maybe perhaps
25 examples were thrown out at the first meeting. I

KEN SCHANZER & ASSOCIATES, INC. (954) 922-2660



Lorraine Christine Hoffman, Esq.
Assistant Staff Counsel
The Florida Bar
File No. 2003-51, 109(15C)

You will note in Mr. Wheeler's letter that is written to Richard Rosman, Esq. a Harvard graduate with both a law and CPA degree from this most established and respected institution, that Mr. Wheeler on PR letterhead states the term "we" repeatedly and never refers to outside counsel or other attorneys! He states that "we" have procured patent counsel, which would refer to Kenneth Rubenstein and never refers in any sense to outside counsel. The letter was requested by Mr. Rosman as the esteemed Hassan Miah, (creator of the Intel/CAA multi-media lab that spawned the Internet as a multi-media vehicle) had requested confirmations from Mr. Rubenstein and Proskauer to their analysis of the Intellectual Properties. Mr. Wheeler then writes a similar letter to Gemal Seede at the bequest of Mr. Epstein to induce Mr. Seede for investment in Iviewit. Mr. Wheeler acts in his deposition statements as if he never knew what the technologies were all about, although he had Mr. Rubenstein opining and was having the product reviewed by Real 3D and was fully in the correspondence loop on all these transactions with the Company and penned the above letter himself. He was distributing business plans and heading meetings with potential investors regarding the products as outlined in the business plan, and securing investment based on these statements.

We submit more from the Wachovia Private Placement as authored, reviewed, billed for by Proskauer Rose and disseminated by Mr. Wheeler showing that he had intimate knowledge of all imaging and video concepts created by Iviewit, evidencing further perjured statements in his deposition whereby he claims no knowledge of the video invention and its applications for iviewit:



Lorraine Christine Hoffman, Esq.
 Assistant Staff Counsel
 The Florida Bar
 File No. 2003-51, 109(15C)



CONFIDENTIAL

I. EXECUTIVE SUMMARY

Transaction Overview

Wachovia Securities, Inc. ("WSI") has been engaged by iviewit Holdings, Inc. ("iviewit" or the "Company") as its exclusive agent to assist the Company in raising up to \$12 million in preferred equity capital to become a leading end-to-end solutions provider of video and imaging products for delivery over the Internet. The Company is a developer and provider of proprietary, leading-edge visual and audio enabling, processing technologies supporting rich media streaming and imaging over the Internet. The Company can process and encode (digitize and compress) virtually all types of audio and video media into a variety of Internet-enabled formats while also optimizing the content for distribution across a variety of bandwidths. Using its technology, iviewit can provide multimedia solutions for Internet and CD-based applications. Also, iviewit can store, host, and distribute media content at its data centers or through multiple hosting partners.

iviewit is the leadership company providing video streaming technologies that deliver a rich video experience with virtually distortion-free, full screen capability at normal, TV-equivalent frame rates of 29.97 fps (frames per second) and providing imaging technologies that deliver rich images over the Internet. Similarly, iviewit is the first and only company to provide virtual imaging that preserves and delivers full image quality and detail of the original image - without distortion - not only during compression (up to 100:1), but also through high resolution zooming and panning.

The Company's revenue model is based primarily on encoding, serving, and licensing revenues. The Company commercialized its products in May 2000. Within a short period of time, iviewit has secured 17 customers - primarily in the entertainment, advertising, and hotel markets and many are high profile industry customers. The Company expects to realize approximately \$400,000 in revenue by year-end from these customers.

The Company has developed and launched the following three breakthrough video/audio streaming and image enhancement technologies that enable:



1. **full-screen, full-frame rate video** (including CD quality audio) at 150-300 Kbps, and at lesser bandwidths, a markedly improved video quality over current industry standards, as depicted below:

<u>Bandwidth Range</u>	<u>iviewit Frame Rate</u>	<u>Industry Typical Frame Rate</u>
28-56 Kbps	8-15 frames/sec.	4-8 frames/sec.
56-150 Kbps	15-30 fps	12-20 fps
150-300 Kbps	30 fps	12-24 fps



2. **full-screen, high definition pictures** that have "scan, pan and zoom, and virtual tour" capabilities at all bandwidths



3. **high fidelity, audio streams** at bandwidths as low as 56 Kbps and mono streams at bandwidths as low as 28.8 Kbps.

iviewit, located in Boca Raton, Florida, was formed in 1999 under the laws of the state of Delaware. Over the past year, iviewit has confirmed the efficacy and reliability of its technologies, initiated digital imaging production, established a demonstration website, developed an initial key management infrastructure, and hired an initial sales and production staff.

The Company continues to pursue an aggressive intellectual property strategy. iviewit has protected its enabling technologies by filing 6 patent pending applications in both the United States and abroad for its video streaming and imaging capabilities, covering a wide array of enabling technologies. The Company also has two remaining provisional patent pending applications that will be converted to patent pending status within the allowable period. The



Lorraine Christine Hoffman, Esq.
Assistant Staff Counsel
The Florida Bar
File No. 2003-51, 109(15C)

And other evidences throughout the plan of the applications of the technologies:

iviewit plans to leverage its imaging and video technologies into three primary markets: Entertainment, E-commerce, Distance Learning/E-Learning. For intellectual property owners, including film studios, record companies, independent film producers, television networks, sports leagues, etc., iviewit's technologies mean that video streaming can finally become a revenue source. Most of these firms have already begun to stream promotional clips over the Internet. Few, if any, have monetized their content.

p.5 Wachovia BP

Currently, the Company is in negotiations with several large, video-content providers regarding licensing its video streaming technologies. iviewit is moving aggressively towards executing two or three landmark licensing agreements in order to facilitate the broader market adoption of its video streaming technology as the industry standard. As the Company continues these negotiations, it anticipates honing its pricing strategy for other comparable, large-content providers.

p.6 Wachovia BP

And as late as 12/2000 we are still "retaining" Kenneth Rubenstein per the Wachovia Private Placement. It is interesting to note that in Mr. Rubenstein's statements to the Bar of New York, he denies knowledge of being an advisor to the Board and claims it was done without his knowledge. The plan was sent to Mr. Rubenstein repeatedly and was authored under sworn statements as to the accuracy by Mr. Utley and reviewed and billed for by Proskauer Rose.

From Mr. Rubenstein's response to the New York Bar we submit the following statements, which try and minimize the role he played and somehow state that Mr. Bernstein listed Mr. Rubenstein without his permission as an advisor. We submit the entire content of Mr. Rubenstein's response as [Exhibit H](#):



Lorraine Christine Hoffman, Esq.
Assistant Staff Counsel
The Florida Bar
File No. 2003-51, 109(15C)

Mr. Bernstein's complaint also alleges that Mr. Rubenstein served as a member of Iviewit's advisory board. Although the relevance of this claim is unclear, there is no truth to it. Iviewit apparently listed Mr. Rubenstein as an advisory board member on its website without Mr. Rubenstein's permission. Indeed, Mr. Utley confirmed at his deposition that Mr. Rubenstein was not on Iviewit's advisory board:

- Q. Okay. So Rubenstein's sole role, from what you understand, is he referred Iviewit to the Meltzer Lippe Law Firm in New York?
- A. Yes.
- Q. Was he ever part of an advisory board or was he an advisory board member to Iviewit? And we're talking about Mr. Rubenstein.
- A. I have never used him as an advisory board member.
- Q. Are you aware of whether or not he ever attended any board meetings with the directors of Iviewit?
- A. He never attended a board meeting. I've never met the man.

Page 9 – Rubenstein response to New York Bar.

From the Wachovia Private Placement that was distributed again and again by Mr. Wheeler to potential clients and was billed for over and over again by Proskauer, we submit in direct contradiction to Mr. Rubenstein's and Wheeler's bogus claims:



Lorraine Christine Hoffman, Esq.
 Assistant Staff Counsel
 The Florida Bar
 File No. 2003-51, 109(15C)



CONFIDENTIAL

II. INVESTMENT HIGHLIGHTS

- ◆ ***Unique processing technologies for video and imaging***

iviewit's patent pending processing technologies can create high-definition images with "scan, pan, and zoom" capabilities, high-fidelity audio streams, and full-screen, full-frame rate video for streaming over the Internet. The iviewit video technology is a highly scalable process. The resulting files are approximately 25% less than comparable quality files. iviewit 220Kps streams are equivalent to competitive 300Kbps streams. The Company's imaging process delivers images that are photo-quality, resistant to pixelation even at magnification levels of 30+:1. Images produced by iviewit's proprietary process are identical in quality regardless of the end-user's Internet connection speed. File size options are tailored to minimize download times and optimize the end-user's experience.

- ◆ ***Complementary and Seasoned Fortune 100 and Entrepreneurial Management Team***

iviewit has assembled a complementary and seasoned management team with Fortune 100 and early-stage, entrepreneurial experience. Management consists of former IBM operations executives who have experience in building video delivery capabilities and of marketing talent from successful venture-backed technology companies. The Company recognizes its strength in operations and product development and recognizes the need to attract a capable, experienced CEO and CTO to accelerate the Company's development. iviewit has retained Korn / Ferry to assist in the identification and recruitment of this talent.

- ◆ ***Strong and Experienced Board of Directors and Advisory Board***

iviewit's Board of Directors and Advisors consist of several well-established individuals from the technology, entertainment, and financial community. Directors have extensive backgrounds with top-tier firms such as Goldman Sachs, Kidder Peabody, and McKinsey & Co. Crossbow Ventures has provided \$3.0 million in funding and sits on the Board. Technology and entertainment guidance comes from a partner at Armstrong Hirsch Jackoway & Wertheimer and from Kenneth Rubenstein, the head of the MPEG-2 patent pool.

- ◆ ***Significant Intellectual Property Position and Strategy***

iviewit has protected its enabling technologies by filing 6 patent pending applications in both the United States and abroad for its video streaming and imaging capabilities, covering a wide array of enabling technologies. The Company also has two remaining provisional patent pending applications that will be converted to patent pending status within the allowable period. The Company has retained Foley & Lardner to shepherd its patent development and procurement. In addition, the Company has retained Kenneth Rubenstein of Proskauer Rose, LLP to oversee its entire patent portfolio. The Company's strategy is to establish market precedence through licensing of trade secrets and know-how.

- ◆ ***Substantial Market Penetration and Growing Customer Acceptance***

The Company commercialized its products in May 2000. In just 5 months, iviewit has experienced a 75% success rate in obtaining service and licensing customers, securing 17 customers to date – primarily in the entertainment, advertising, and hotel markets. The Company expects to realize approximately \$400,000 in revenues by year-end from these customers. High profile customers include Ellen DeGeneres, Z.com (Alanis Morissette), Hyatt Hotels, Gear Magazine, and Hollywood.com. Highly probable for closing by year-end 2000 include Warner Brothers and Greg Manning Collectibles.

- ◆ ***Focused on Media Rich Target Markets – Unlocking the Value of Content***

The Company's business strategy is to first target high-profile content owners and distributors as clients to process video and images and to brand those images with iviewit's logo. Secondly, iviewit plans to co-brand with famous celebrities and



Lorraine Christine Hoffman, Esq.
 Assistant Staff Counsel
 The Florida Bar
 File No. 2003-51, 109(15C)

And further from that certain Private Placement Memorandum:



CONFIDENTIAL

Investment Management, both based in London. Among his primary areas of expertise are technology research and economic research, including electronics, telecommunications and computer software. Most recently, he was Senior Technology Analyst and Vice President of Southeast Research Partners, Inc. where he worked with leading technology companies. He earned a bachelor of arts degree at Yale University and a master of business administration degree at Stanford University.

Advisors

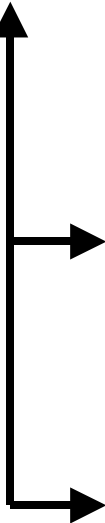

Alan J. Epstein
Partner, Armstrong Hirsch Jackoway Tyerman & Wertheimer, P.C.
 Mr. Epstein's law practice consists of advising Internet companies on various issues pertaining to the entertainment and sports industries, including the creation, licensing and acquisition of content, the introduction and negotiation of strategic partner relationships, and various other matters relating to the convergence of technology and content. Mr. Epstein also advises his firm's numerous celebrity clients on the exploitation and protection of their name and likeness rights and content on the Internet, as well as merchandising, endorsement and sponsorship deals. Prior to entering the UCLA School of Law, Mr. Epstein was a certified public accountant at Deloitte Haskins & Sells in Dallas, Texas.

Kenneth Rubenstein
Partner, Proskauer Rose LLP
 Mr. Rubenstein is a partner at Proskauer Rose LLP law firm and is the patent attorney for iViewit. He is a registered patent attorney before the U.S. Patent & Trademark Office. Mr. Rubenstein counsels his clients with respect to the validity and infringement of competitors' patents, as well as prosecutes patent applications. For the past several years he has worked on the formation of a patent pool, for MPEG-2 technology, involving large consumer electronics and entertainment companies. He is also a former member of the legal staff at Bell Laboratories. Mr. Rubenstein received his law degree, cum laude, from New York Law School, and his Ph.D. in physics from the Massachusetts Institute of Technology where he also graduated with a B.S. Degree.

Christopher C. Wheeler
Partner, Proskauer Rose LLP
 Mr. Wheeler is a member of Proskauer Rose LLP's Corporate Department and as a partner in the Florida office has a versatile transactional practice. He has had extensive experience in real estate and corporate law, institutional lending and workouts, administrative law and industrial revenue bond financing. Moreover, he serves as a strategist and counselor to many clients in handling their other legal and business matters. Mr. Wheeler is well-versed in general corporate law as well as mergers and acquisitions and securities matters. He has guided companies from startup through initial private placements to public offerings. A graduate of Hamilton College and Cornell Law School, Mr. Wheeler was a member of the managing Board of Editor of the Cornell Law Review.

Legal & Accounting Counsel

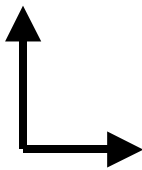

Arthur Andersen, LLP
 Arthur Andersen's vision is to be the partner for success in the New Economy. The firm helps clients find new ways to create, manage and measure value in the rapidly changing global economy. With world-class skills in assurance, tax, consulting and corporate finance, Arthur Andersen has more than 70,000 people in 83 countries that are united by a single worldwide operating structure that fosters inventiveness, knowledge sharing and a focus on client success. Since its beginning in 1913, Arthur Andersen has realized 86 years of uninterrupted growth, with 1999 revenues over \$7 billion. Arthur Andersen is a business unit of Andersen Worldwide.

Proskauer Rose, LLP
 This law firm is one of the nation's largest law firms, providing a wide variety of legal services to major corporations and other clients through the United States and around the



Lorraine Christine Hoffman, Esq.
Assistant Staff Counsel
The Florida Bar
File No. 2003-51, 109(15C)

◆ ***Significant Intellectual Property Position and Strategy***

iviewit has protected its enabling technologies by filing 6 patent pending applications in both the United States and abroad for its video streaming and imaging capabilities, covering a wide array of enabling technologies. The Company also has two remaining provisional patent pending applications that will be converted to patent pending status within the allowable period. The Company has retained Foley & Lardner to shepherd its patent development and procurement. In addition, the Company has retained Kenneth Rubenstein of Proskauer Rose, LLP to oversee its entire patent portfolio. The Company's strategy is to establish market precedence through licensing of trade secrets and know-how.



◆ ***Unique processing technologies for video and imaging***

iviewit's patent pending processing technologies can create high-definition images with "scan, pan, and zoom" capabilities, high-fidelity audio streams, and full-screen, full-frame rate video for streaming over the Internet. The iviewit video technology is a highly scalable process. The resulting files are approximately 25% less than comparable quality files. iviewit 220Kps streams are equivalent to competitive 300Kbps streams. The Company's imaging process delivers images that are photo-quality, resistant to pixelation even at magnification levels of 30+:1. Images produced by iviewit's proprietary process are identical in quality regardless of the end-user's Internet connection speed. File size options are tailored to minimize download times and optimize the end-user's experience.

◆ ***Substantial Market Penetration and Growing Customer Acceptance***

The Company commercialized its products in May 2000. In just 5 months, iviewit has experienced a 75% success rate in obtaining service and licensing customers, securing 17 customers to date – primarily in the entertainment, advertising, and hotel markets. The Company expects to realize approximately \$400,000 in revenues by year-end from these customers. High profile customers include Ellen DeGeneres, Z.com (Alanis Morissette), Hyatt Hotels, Gear Magazine, and Hollywood.com. Highly probable for closing by year-end 2000 include Warner Brothers and Greg Manning Collectibles.

p.11 Wachovia BP

And this business plan referenced a new technology, a new era for camera's and imaging devices with out pixilation and now commonly referred to as "digital zoom" available on almost every digital camera being produced.



Lorraine Christine Hoffman, Esq.
Assistant Staff Counsel
The Florida Bar
File No. 2003-51, 109(15C)

3. Digital Cameras and Instrumentation

The broadness of iVIEW!T's technologies and its applications outside an Internet based environment depict the scope of the pending patents and their uses in other markets. One such application is in the huge and growing market for digitization, instrumentation, and consumer products such as the digital camera market. Recently, iVIEW!T and Eastman Kodak began a series of discussions that are now formative, and an agreement could provide significant revenue as early as summer 2001.

The applications for Kodak would follow a logical path to create a value added option that would initially be available on its "high end" digital cameras, and then be led downstream to the broad and sizeable moderately priced digital camera lines. In each case the following would be the applications provided to Eastman Kodak for its new and future camera entries:

p.22 Wachovia BP

Mr. Wheeler is also listed as an advisor to the Board in the Wachovia Private Placement which as will be evidenced he also billed for such review of the plan prior to dissemination.

We cite as evidence:



Lorraine Christine Hoffman, Esq.
Assistant Staff Counsel
The Florida Bar
File No. 2003-51, 109(15C)

-----Original Message-----

From: eib [mailto:alps@netline.net]
Sent: Sunday, May 30, 1999 11:08 AM
To: Kenneth Rubenstein (E-mail); Christopher C. Wheeler (E-mail); Jefferey Friedstein (E-mail); Jefferey Friedstein (E-mail); Donald G. Kane II (E-mail)
Subject: FW: iviewit, inc.

-----Original Message-----

From: Hassan Miah [mailto:hmiah@xingtech.com]
Sent: Sunday, May 30, 1999 1:19 PM
To: 'eib'
Subject: RE: iviewit, inc.

Not yet. I will work out a meeting time over the next couple of days. I was looking at the profile of Ken Rubinstein at Proskauer, very impressive!
Is he the person that reviewed your patent application? Ken appears to be the person behind setting up the MPEG patent pool. Xing is a licensee under this. Do you mind if I e-mail Ken questions about the nature of the patent?
Also, I have not heard from Goldman.

This project is very exciting to me. I keep thinking about the possibilities. Hopefully you, Kevin and I can meet over the next couple of weeks so we can accelerate our activities. How are you doing setting up the demo to view over the Internet? My home number is 805-594-0292 if you want to talk.

Hassan

> -----Original Message-----

> From: eib [SMTP:alps@netline.net]
> Sent: Saturday, May 29, 1999 8:24 PM
> To: hmiah@xingtech.com
> Subject: iviewit, inc.

>

> <?XML:NAMESPACE PREFIX = O />

>

> Hassan,

>

> Have you heard any news from Kevin? Hope all is going well.

>

> Eliot



Lorraine Christine Hoffman, Esq.
Assistant Staff Counsel
The Florida Bar
File No. 2003-51, 109(15C)

And from Mr. Rubenstein's deposition:

14 How about a Hassan Miah?
15 A. I don't know who he is.

From this next piece of evidence you will find Kenneth Rubenstein on the appointment distribution list, the memo that is authored by Wheeler and sent to lead investor Crossbow Ventures Hank Powell is to deal with patent issues surrounding Raymond Joao's work:

-----Original Appointment-----

From: iviewit
Sent: Monday, June 07, 1999 7:52 PM
To: iviewit; Simon L. Bernstein (E-mail); Raymond A. Joao (E-mail); Christopher C. Wheeler (E-mail); Kenneth Rubenstein (E-mail); Kevin J. Healy (E-mail); Jefferey Friedstein (E-mail); Jefferey Friedstein (E-mail 3); Donald G. Kane II (E-mail); Hassan Miah (E-mail); Richard Rosman (E-mail)
Subject: Hassan and technician out to review iviewit patent information
When: Thursday, June 10, 1999 9:00 PM to Friday, June 11, 1999 9:00 PM (GMT-08:00) Pacific Time (US & Canada); Tijuana.
Where: Florida - Proskauer

**Spoke with Hassan he will call back with exact travel times -
Friday is day to discuss patent and related issues.**

And another Email to Mr. Rubenstein regarding Hassan Miah;



Lorraine Christine Hoffman, Esq.
Assistant Staff Counsel
The Florida Bar
File No. 2003-51, 109(15C)

-----Original Message-----

From: EIB [mailto:alps1@bellsouth.net] **On Behalf Of** EIB

Sent: Wednesday, April 28, 1999 9:58 AM

To: Kenneth Rubenstein (E-mail); Christopher C. Wheeler (E-mail)

Subject:

Dear Ken & Chris,

I have a meeting with this gentlemen today at 1:30pm Eastern. We are trying to get him on board at President/CEO level. If you have anybody who knows him at the firm, please call ASAP.

Thank you again,
Eliot I. Bernstein

Under oath and what you will find in the depositions of Wheeler and Rubenstein is that every time these attorneys were questioned on patents, they claimed basic Alzheimer's and could not remember or found similar excuses to deny direct questions regarding patent billings contained in their own billing records. Judge Labarga has granted the Company's request to re-depose the attorneys and ordered them to answer the questions they have refused to do in their past depositions submitted to the Bar of Florida .

Mr. Rubenstein appears in almost all business plans in Advisory Board capacity and it was his name and support that led investors to believe in the strength of the patents that he was overseeing. Christopher Wheeler and Brian Utley joint authored almost all of these business plans as well as disseminated them to all clients. Note that Ken Rubenstein in the Wachovia Private placement is claimed to be retained to oversee the patents. Note that in David Colter's of WB letter to the AOLTW investment group that it was Mr. Rubenstein who opined favorably on the patents that led to WB utilizing our processes.



Lorraine Christine Hoffman, Esq.
Assistant Staff Counsel
The Florida Bar
File No. 2003-51, 109(15C)

VIII. Evidence showing Kenneth Rubenstein and Mr. Wheeler's involvement with the Warner Bros. transaction. The Conflict of Interest that arose and the damaging position Rubenstein put the Company in by his refusal to repeat his prior statements to Warner Bros. representatives.

We submit the following as evidence to refute Mr. Rubenstein's sworn deposition testimony that he had no involvement with Warner Bros. and Iviewit. This letter is from David Colter the SVP of Advanced Technologies at WB in charge of the Iviewit Account



Lorraine Christine Hoffman, Esq.
Assistant Staff Counsel
The Florida Bar
File No. 2003-51, 109(15C)

Subj: **iviewit**
Date: 1/14/2002 9:51:08 PM Pacific Standard Time
From: David.Colter@warnerbros.com (DColter0264)
To: John.calkins@warnerbros.com
CC: CHuck.dages@warnerbros.com, Alan.Bell@warnerbros.com (ABell0648)
Sent on: AOL 6.0 for Windows US sub 10551

John,

In all the review we have done with iviewit it seems to boil down to the status of the patents and their inherent value. At that point it is a risk-reward evaluation -- without awarded patents it is difficult to completely assess the value. I would suggest that we consider one other perspective...

Prior to iviewit (approx Feb 2000) the video we (WB Online) delivered on the web was QCIF (160x120) or smaller and was below full frame rate. At the time of our first meeting we also identified On2 along with iviewit as two solid players who could deliver full screen full frame rate web video. All who saw it were impressed. Greg and I visited iviewit in August and reported back that they had filed patents on scaling techniques that hinged upon a visual 'trick' which allowed the human eye to accept 320x240 video scaled to 640x480 at 30 fps as close to VHS quality. **We checked with Ken Rubenstein and others who provided some solid support for iviewit, and Chris Cookson asked Greg and I to continue to work with iviewit in an R&D capacity.**

In the fall of 2000 iviewit also met with a number of folks at WB Online (in September and October) and demonstrated their process and techniques to Sam Smith, Houston, Joe Annino and others. Sam contacted iviewit a number of times and requested the patents, along with specifics of the iviewit process to evaluate what they were doing. I was not part of these meetings, but was aware they had occurred, as Jack Scanlon kept me up to date.

When I sat down with Morgan and Houston in March 2001 to see what technology they were using to encode video, it was clear that they were using some of the techniques that would overlap with iviewit's filed process patents (still pending), but it is not clear that these were all learned from iviewit -- we may wish to explore this a little. This meeting was to determine what equipment we would get for our lab at 611 Brand. This same information was also provided to iviewit by Morgan as they were establishing the company as an outsourcing facility for encoding our content.

I am aware of several meetings held between iviewit and WB Online to share information of techniques and process, and was invited to a few of them.

We all signed iviewit's confidentiality agreement. So to the other perspective....

We have an opportunity to establish a license with iviewit for a modest fee at this time, and establish a MFN. In good faith we signed the confidentiality agreement, iviewit revealed their processes and techniques, and we now use those techniques in encoding. As we have discussed on a few occasions, these techniques now appear in the public domain to some extent in documentation for Real Producer, WMP Developer Guides, Media Cleaner Pro, etc, but they were not available in 2000. I would not suggest we learned the techniques completely from iviewit (I actually do not know the answer), but a modest licensing fee may be appropriate and honorable considering our good faith relationship in signing the confidentiality doc.



Lorraine Christine Hoffman, Esq.
Assistant Staff Counsel
The Florida Bar
File No. 2003-51, 109(15C)

If we choose to pass at this time the risk is primarily from iviewit's main investor, Crossbow Ventures, gaining control of the IP and approaching WB later for a license -- I do not believe they will be as friendly considering their dealings with iviewit and it's employees since Feb of 2001. It is estimated that the patents will be completed in 8-12 months.

As you are all aware I have a personal relationship with Eliot Bernstein, the founder of iviewit, and as a result, I left the evaluations and decisions to Greg, and others, and only assisted iviewit to get to the correct people in WB and AOLTW. I wanted to add this perspective as we consider if there is an option to pursue with iviewit -- they are facing continued financial pressure right now. There are many other threads to our interaction with iviewit and I would be happy to discuss.

Thanx,
David

And again Mr. Colter writes to a Senior Investment contact at AOLTW, we submit:



Lorraine Christine Hoffman, Esq.
Assistant Staff Counsel
The Florida Bar
File No. 2003-51, 109(15C)

-----Original Message-----

From: David.Colter@warnerbros.com [mailto:David.Colter@warnerbros.com]
Sent: Thursday, August 02, 2001 1:28 AM
To: HeidiKrauel@aol.com
Cc: HPowell@cb-ventures.com; Eliot@iviewit.com
Subject: Re: Today -- iviewit

Heidi,

Here is the info for Hank Powell from Crossbow Ventures. I have copied him above to make the introduction.

iviewit has undergone a restructuring of their business from an encoding focused business to a technology licensing business focus over the past 4-5 months. They are in the process of establishing a new executive team to handle this 'new' direction and have been working on the new business plan. They have indicated that we should have the revised plan next week.

They currently are finalizing a contract with WB Online to provide encoding services as a hold over from our original collaboration, and as a showcase for the technologies and patents.

Their site www.iviewit.com contains good demonstrations of the zooming and video encoding technologies. I have also copied the inventor/founder Eliot Bernstein, who I will ask to provide some specific links on the site to see the best representation of their work and technical capabilities.

Their patents are pending, but have received favorable opinions from people such as Ken Rubenstein on the merit of the patents, as well as thorough review by Greg Thagard and myself.

Let's talk further after you see the business plan and connect with Hank.

Thanx,
David

Hank Powell
Managing Director

CrossBow Ventures
One North Clematis Street
Suite 510
West Palm Beach, FL 33401-5523
T +1(561) 838-9005 (office)
T +1(561) 279-0556 (home)
T +1(561)310-9171 (cellphone)
F +1(561) 838-4105
HPowell@cb-ventures.com
www.cb-ventures.com

In a message dated 07/26/2001 8:01:54 AM Pacific Daylight Time, HeidiKrauel writes:



Lorraine Christine Hoffman, Esq.
Assistant Staff Counsel
The Florida Bar
File No. 2003-51, 109(15C)

And next we submit a letter summarizing to Goldman Sachs Managing Partner the conversations occurring between Rubenstein and Thagard that led to WB signing contracts with Iviewit and the formation by Irell and Manella law firm for an Advanced Royalty Agreement for the I View It technologies



Lorraine Christine Hoffman, Esq.
Assistant Staff Counsel
The Florida Bar
File No. 2003-51, 109(15C)

-----Original Message-----

From: Eliot I. Bernstein [mailto:eliot@iviewit.com]
Sent: Thursday, November 02, 2000 11:44 PM
To: Friedstein, Jeff; Jeffrey Friedstein (E-mail 2)
Subject: FW: iviewit
Importance: High

-----Original Message-----

From: Eliot I. Bernstein
Sent: Friday, November 03, 2000 2:43 AM
To: Donald G. Kane II (E-mail)
Subject: iviewit
Importance: High

www.iviewit.com

Friday, November 3, 2000

Don,

The investor calls with Warner Brothers went extremely well. They confirmed the efficacy of the technologies and that they cover a broad array of applications outside of the Internet space, i.e. wireless, network and DVD. They commented on the strength of the mathematics behind the patents as being a major impacting force on video encoding of any sort. They maintained that by New Years it would begin being rolled out across their networks and for their daily's. On imaging they commented that the entire Time-Warner domains would utilize the technology.

Ken Rubenstein & Greg Thaggard will be talking about how to protect the intellectual property over the next few weeks, to determine an amount of investment that either Warner Bros or Time-Warner will be making.

Crossbow was on one of the calls and they have committed to us that they will continue funding our operations and will be happy to come in alongside anyone else on a larger raise.

David Colter will begin documenting his statements over the next few days and will evolve these comments into a joint press release.

I would love to have your feedback at your earliest convenience. I have some kidney stones that I now must deal with so I may be home tomorrow at 800.519.0234 or on my cell. I will undergo tests starting at 2:45pm.

Hope your travels are going well.



Lorraine Christine Hoffman, Esq.
Assistant Staff Counsel
The Florida Bar
File No. 2003-51, 109(15C)

Eliot
Eliot I. Bernstein
Founder & Vice Chairman
iviewit.com
2255 Glades Road
Suite 337 West
Boca Raton, FL 33431
email: eliot@iviewit.com
palm: iviewit@palm.net
Web: www.iviewit.com
Voice: 561.999.8899
Fax: 561.999.8810
Toll: 877.484.8444
Cell: 561.212.9254

NOTE: The information transmitted in and/or attached to this message is intended only for the person or entity to which it is addressed and may contain confidential and/or privileged material. Any review, retransmission, dissemination, or other use of, or taking any action in reliance upon, this information by persons or entities other than the intended recipient is prohibited. If you received this information in error, please contact the sender and delete the material from any computer.

Never was it disclosed or a COI taken regarding Mr. Rubenstein and Mr. Thagard having had prior involvements together and would benefit from Iviewit technologies for the DVD patent pool that Mr. Thagard holds @13 patents for and Mr. Rubenstein is involved as counsel for. DVD's now commonly are created using Iviewit technologies, and Iviewit receives no royalties from such usage.

And from the then CFO of Iviewit of the company we find the following letter that was circulated to Investors and potential investors a list that can be furnished upon request:



Lorraine Christine Hoffman, Esq.
Assistant Staff Counsel
The Florida Bar
File No. 2003-51, 109(15C)

Dear Alan and Larry,

At Eliot's request, and following your conversation with iviewit today, the following will reflect the detail of the Warner Brothers situation. This additional information is derived from a series of 5 telecons that iviewit was authorized to conduct with Warner Brothers last Wednesday.

David Colter is VP for Advanced Technology at Warner Brothers. David and others at Warner Brothers/Time Warner have been looking at our technology for the past eight months. They have visited our facilities, and they are fully sophisticated and familiar with our industry, the applications of our technology and the future direction of these technologies in many applicable and competitive markets.

After the most intensive reviews, David has advised iviewit that he has been instructed that his group and infrastructure are to facilitate, in whatever ways possible, iviewit moving its business and technology forward. They are under an NDA (something they rarely do!), and they have thoroughly reviewed our patents pending portfolio. From my notes and quotes from the telecons, they consider iviewit's "technology and patents" to be "fundamental" and "of critical importance" not only for internet applications, but across a broad spectrum of applications as a possible standard for such areas as broadcasting, wireless transmission, instrumentation (i.e., cameras, scanners, etc.), DVD, HDTV, plus a myriad of other uses. Colter also called our patents "very key" in one of the phone calls. Warner's decision to speak on our behalf on Wednesday represented a starting point for them to publicly acknowledge this.

In the various meetings, Colter was drawn out by analyst questions and addressed a number of issues. However, while he answered many, Warner is still playing it very conservatively with respect to some business issues because they will "in the next couple of weeks" have finished their review of the licensing and broad approaches for this intellectual property and how it would apply regarding broad licensing (i.e., MPEG pools and others) in many business spaces. At the conclusion of that phase, we have been given every reason to expect, and Colter confirmed this in the discussions last Wednesday, that Warner Brothers and Time Warner will move the relationship to their internal investment groups for a likely equity investment in iviewit. Hence, their otherwise somewhat cautious comments with other potential investors.

(Relative to "the next couple of weeks" referenced in the previous paragraph, a critically important telecon took place this past Tuesday involving one of Warner's other top technology guys, who teams with Colter on iviewit, and one of our principal patent experts/advisors. It went extremely well and further "greases the wheel" with Warner.)

Warner Brothers is currently beginning a series of gradual rollouts of the iviewit technology in several areas, including WB Online and Entertainment, plus "digital dailies." Colter projected that to occur "by the beginning of the new year." However, their interests far transcend just the Internet. They are looking at our technologies for possible uses in DVD, broadcasting, and theatre environments. Colter also said that they want to develop with us an expanding, collaborative R&D program, and they have introduced us to other entities that they believe will also become leading complementary technologies in the future of visual content processing, encoding and delivery where he identifies iviewit's technology as a "critical" and "central" driver. He also said that the small size of our Company did not present any obstacle for a Company like Time Warner to be significantly involved in. He said his goal and their corporate strategy was to find the very best platforms by blending the best through working relationships with other companies that were becoming recognized as leaders in (1) the pre-processing of video



Lorraine Christine Hoffman, Esq.
Assistant Staff Counsel
The Florida Bar
File No. 2003-51, 109(15C)

before encoding, (2) enhancements for existing MPEG 2, and (3) variations and improvements to MPEG 4.

Further with respect to our pending patents, he said they were "very broad, mathematical" and were "efficiency equations" that apply to many, many forms of use, both now and in the future. He said that his group has reviewed "what is out there and exists", and iviewit was in the select grouping of technologies that apply to areas (1) to (3) as described above. He said they were in the process of quantifying much of this over the near term to best provide for Time Warner the most effective presentation of its product now and into the future, and from, a business standpoint, to position themselves and iviewit technologically in as many markets as possible.

We are currently in separate discussions with AOL and other elements of Time Warner and are gradually being introduced to additional entities within their myriad of entities as they apply to the use of our streaming and imaging technologies.

I trust this provides you with some additional valuable insights as to iviewit. Eliot would be flattered to have you folks as iviewit investors, and he is absolutely certain that your investment will yield you very high returns. We would like to move that conversation along

Sincerely yours,

Raymond Hersh/CFO

And finally, after Mr. Utley claims he has consulted with Proskauer Rose and Kenneth Rubenstein regarding sending highly confidential patent information to almost all contacts of WB as illustrated in his previous letter to the Board, causing great concern that led to WB pulling out of a major deal with iviewit, Mr. Rubenstein is requested to speak to Senior Patent Attorney for AOLTW/WB Mr. Wayne Smith. What follows here is copies of the responses CEO Lamont and Mr. Bernstein were forced to send to Mr. Colter and the correspondences surrounding this situation. Mr. Rubenstein declines to say anything in his deposition at this point citing a COI for himself between Iviewit and Warner Bros a COI that was never disclosed prior when he had interfaced on behalf of Iviewit.

We submit the following correspondences:



Lorraine Christine Hoffman, Esq.
Assistant Staff Counsel
The Florida Bar
File No. 2003-51, 109(15C)

-----Original Message-----

From: PSLamont39@aol.com [mailto:PSLamont39@aol.com]
Sent: Friday, December 21, 2001 6:58 AM
To: eliot.bernstein@verizon.net
Subject: Ken Rubenstein

Spoke with him last night, and he indicates he is willing to speak on our behalf. However, Time Warner is a big client in their NYC office, and it appears that there would be a major conflict of interest in him speaking to Wayne Smith.

Good, down to Earth guy, I might add.

PSL

Further:

-----Original Message-----

From: Eliot I. Bernstein
Sent: Thursday, January 17, 2002 11:22 AM
To: P. Stephen Lamont
Subject: iv
Importance: High
Sensitivity: Confidential

Stephen,
Spoke with David and Wayne Smith addressed his letter but wants to talk with Ken Rubenstein. He feels that we can wave confidentiality issue on I View It side and he can speak with him with you on line.

This next letter was written to the contact Chuck Brunelas that introduced the Company to Ted Leonsis of AOLTW who was overseeing the AOLTW/WB/Iviewit deal for Ted Leonsis one of the Founding Fathers of the Internet, and this is significant in that Rubenstein's refusal was reaching top management levels and causing the account to come under question.

As Vice Chairman of America Online, Inc., Ted Leonsis oversees the flagship AOL service and chairs committees overseeing brand, product, and technology. As President of the Advanced Products Group, he oversees development of new products and consumer



Lorraine Christine Hoffman, Esq.
Assistant Staff Counsel
The Florida Bar
File No. 2003-51, 109(15C)

services and leads cutting-edge efforts to create new and scalable businesses and services for AOL.

Considered a founding father of the new media industry, Leonsis is one of the foremost leaders and visionaries of the Internet and new media.

And we submit the following as evidence:

-----Original Message-----

From: Eliot I. Bernstein
Sent: Thursday, January 17, 2002 12:08 PM
To: 'Chuck Brunelas'
Subject: RE: You OK?
Importance: High

[David got a response back from Wayne smith patent attorney and he was not so neg as first letter, he still wants to talk to **Ken Rubenstein** and I am trying to have Stephen arrange a call. **ken has a conflict since he reps both sides but we should get around through mutual release.**](#)

-----Original Message-----

From: Chuck Brunelas [mailto:cbrunelas@osisystems.com]
Sent: Thursday, January 17, 2002 9:01 AM
To: Eliot I. Bernstein
Subject: Re: You OK?

Yep tried reaching Melnychuck last night, but he was not there –

Then CEO Lamont writes to Mr. Rubenstein the following letter and subsequently meets with him in NY where Rubenstein claims virtually no knowledge of the Company.



Lorraine Christine Hoffman, Esq.
Assistant Staff Counsel
The Florida Bar
File No. 2003-51, 109(15C)

-----Original Message-----

From: Eliot I Bernstein [mailto:res0bf4a@verizon.net]
Sent: Thursday, December 20, 2001 11:28 AM
To: PSLamont39@aol.com
Subject: RE: For Your Records
Importance: High

Thanks, great letter.

-----Original Message-----

From: PSLamont39@aol.com [mailto:PSLamont39@aol.com]
Sent: Thursday, December 20, 2001 11:01 AM
To: eliot.bernstein@verizon.net
Subject: For Your Records

Subj: **I View It Technologies -- Patents Pending**
Date: 12/20/01
To: krubenstein@proskauer.com

Ken,

By way of introduction, and as of December 3, I am the new CEO of I View It Technologies. Presently, working out of NYC, we are in receipt of a patent review letter from Wayne Smith, Patent Counsel of Warner Brothers.

While the letter speaks positively regarding our pending applications, we feel Wayne has "missed the boat" on a few of the claims we have staked. Having been told that you feel otherwise, I think it would be helpful at this point to have a three way discussion, at your convenience, to address the positive, yet lukewarm in part, position Wayne Smith has taken.

I have left a similar type message on your NYC office voice mail, and I would look forward to briefly speaking with you at your earliest convenience. I can be reached at 914-217-0038. Lastly, I am in the Grace Building just a few blocks from you, and I would welcome the opportunity for a personal meeting to discuss same, as well as some pending matters in your Florida office.

Best regards,
P. Stephen Lamont
CEO
I View It Technologies, Inc.

We further submit that David Colter the account representative for WB in charge of the Iviewit account who had spoken to Mr. Rubenstein in the past was getting disturbed at



Lorraine Christine Hoffman, Esq.
Assistant Staff Counsel
The Florida Bar
File No. 2003-51, 109(15C)

Mr. Rubenstein's refusal which were causing him tremendous personal problems at his job at WB and ultimately led to his being let go of his job over this situation.

-----Original Message-----

From: P. Stephen Lamont
Sent: Thursday, January 17, 2002 5:26 PM
To: Eliot I. Bernstein
Subject: RE: iv
Sensitivity: Confidential

You know, he [Kenneth Rubenstein] told me no twice already...if David [David Colter – Warner Bros.] feels otherwise, why doesn't he coordinate. Does David have any feedback on the ARA?

Best regards,

P. Stephen Lamont
Chief Executive Officer, Director
I View It Technologies, Inc.
10 Mela
Rancho Palos Verdes, Cal. 90275
Tel: 914-217-0038
Email: psl@iviewit; pstephen.lamont@verizon.net
URL: www.iviewit.com

And then:

-----Original Message-----

From: Eliot I. Bernstein
Sent: Thursday, January 17, 2002 5:29 PM
To: P. Stephen Lamont
Subject: RE: iv
Importance: High
Sensitivity: Confidential

David has coordinated his end. Can you email Ken and tell him much is riding on this, what would he feel comfortable doing. Would a release from us/them or both make him comfortable.



Lorraine Christine Hoffman, Esq.
Assistant Staff Counsel
The Florida Bar
File No. 2003-51, 109(15C)

And then Mr. Rubenstein becomes agitated at Mr. Colter's request

-----Original Message-----

From: P. Stephen Lamont
Sent: Friday, January 18, 2002 2:03 PM
To: Eliot I. Bernstein
Cc: david.colter@warnerbros.com
Subject: [Ken Rubenstein](#)

I just spoke with Ken Rubenstein, and he reiterated that he does a lot of work for Warner Brothers and is unable to pick the phone up and discuss the matter on our behalf. Moreover, he is not too pleased that I have asked him to do same in what amounts to the third time.

Lastly, he would welcome a call from Wayne Smith directly and would discuss with him the fact that "he is not too familiar with what [I View It] has," but would not be "negative or positive " in any potential discussion.

Best regards,

P. Stephen Lamont
Chief Executive Officer, Director

Then Mr. Lamont drafted a letter to Mr. Rubenstein that Mr. Rubenstein was presented at his deposition and although he claimed he had not received such letter, and he may not have at the time, he had adequate time to address the contents of such letter at his deposition and instead he became more focused on the fact that the document had an auto-update date and appeared dated on the date of his deposition, although the document was drafted month's earlier. He would not address the content that he reviewed. The letter was created by Mr. Lamont on April 25, 2002 but has an auto-update feature and the date was printed on the date that it is last printed.



Lorraine Christine Hoffman, Esq.
Assistant Staff Counsel
The Florida Bar
File No. 2003-51, 109(15C)

Draft

4/13/2003



IVIEWIT HOLDINGS, INC.

P. Stephen Lamont
Chief Executive Officer
Direct Dial: 914-217-0038

By Electronic Mail and Facsimile

April 13, 2003

Kenneth Rubenstein
Partner
Proskauer Rose LLP
1585 Broadway
New York, NY 10036

Re: Iviewit Patents Pending

Dear Ken:

Last we spoke, Wayne Smith of Warner Bros. requested a conversation with you pertaining to Iviewit patents pending, of which you denied indepth knowledge of same and, additionally, stated conflict of interest issues. Sadly, Iviewit has submitted Return of Property papers and a soon to be issued Cease and Desist letter to Warner Bros. for breach of a Confidentiality Agreement executed in August 2000, and ignorance of a reasonable license agreement to remedy said breach.

In any event, I am writing for another reason as I came across a piece of perplexing information earlier today. I stumbled upon some documentation that named you as an Advisory Board member of the company somewhere between the fall of 1999 and the spring of 2000.

Moreover, recalling your own words, as I sat in your office earlier in the year, of your present unfamiliarity with the Iviewit techniques and unwillingness to speak on behalf of what I have since heard you describe as "novel" approaches to video perplexes me to a certain extent when I view you as a former Advisory Board member, if you ever held such a designation.

Further, and I should not be relaying this to you, but there are rumors swirling around the company with finger pointing and all from Florida to Los Angeles wherein it catches the jet stream and arrives very soon in New York of alleged breaches of confidentiality pertaining to Iviewit technology, transfers of trade secrets, and, even in certain circumstances, knowing and willful invention fraud by the outright switching of signature

10 Mela, Rancho Palos Verdes, Cal. 90275 • T 310-265-1731 F 310-265-1730 • www.iviewit.com



Lorraine Christine Hoffman, Esq.
Assistant Staff Counsel
The Florida Bar
File No. 2003-51, 109(15C)

Draft

4/13/2003



Kenneth Rubenstein
April 13, 2003
Page 2

pages of patent filings by some earlier patent counsels appointed by the company, including, but not limited to one Mr. Ray Joao, formerly, it is my understanding, of Meltzer, Lippe, Goldstein & Schlissel, P.C., (your former firm) and an individual that, it is also my understanding, you have worked closely with in the past pertaining to Iviewit and other matters. Moreover, it is also my understanding, that you were the first individual to be presented with the Iviewit proprietary techniques, and passed along the work to your past associate, Mr. Joao, and "reviewed" same prior to, during, and, perhaps, after your transition from the Meltzer firm to Proskauer, and in whatever capacity "reviewed" refers to.

At this juncture in my tenure as Iviewit CEO, I have ordered a full legal audit of the company both from a business perspective and an intellectual property perspective. With the results of said audit nearly complete, the preliminary intellectual property conclusions relayed astound me to the point that I have been told that the Iviewit patents pending are akin to patenting "peanut butter."

Furthermore, I have been told of your past involvement with the Iviewit proprietary techniques, of your conversations about the Iviewit techniques with, including, but not limited to, Greg Thagard, Chris Cookson, and David Colter among others, and your initial conclusion of the novelty of the Iviewit techniques, and I ask myself, "Why, why has past patent counsel failed to patent the inventions as specified by our inventor?" Moreover, I ask myself "Why do the description of the inventions fail to lead one to believe that Iviewit had invented anything at all?"

Still further, I think back to the comments I have heard of your initial reaction to the Iviewit techniques and describing them as "novel," which leads me to the conclusion that in your role as overseer of many patent pools, combined with your description of the novelty of the Iviewit techniques, you had not seen scaling in your review of patents pertaining to the essentiality of any given pool, and I ask my self further, "Why is the Iviewit scaling method now so far reaching and ubiquitous in many, varied patent pools overseen by yourself and others of similar stature?"

As such, I would like to enlist your assistance, if available, to review the conclusions of past and present patent counsel, and to further assist Iviewit in further defining the inventions in any intellectual property arena of our choosing, whether it be by a petition by what process is available at the United States Patent and Trademark Office, or any administrative, state, or federal court of appropriate jurisdiction armed with executed documents, memos, emails, and parole evidence all pointing to fraudulent, or at the least, entirely malpractical occurrences regarding the filings of the past Iviewit patents pending.



Lorraine Christine Hoffman, Esq.
Assistant Staff Counsel
The Florida Bar
File No. 2003-51, 109(15C)

Draft

4/13/2003



Kenneth Rubenstein
April 13, 2003
Page 3

Lastly, as I mentioned above, I have ordered a full legal and accounting audit of the company many weeks ago, and I expect the completion of same shortly, and I would appreciate a response at your earliest convenience.

Best regards,

P. Stephen Lamont
Chief Executive Officer



Lorraine Christine Hoffman, Esq.
Assistant Staff Counsel
The Florida Bar
File No. 2003-51, 109(15C)

Then comes a letter to three of the main investment group that brought Wayne Smith in to analyze Rubenstein's work for the AOLTW investment and it is clear that Rubenstein had spoken to WB representatives in the past and his position with Iviewit.



Lorraine Christine Hoffman, Esq.
 Assistant Staff Counsel
 The Florida Bar
 File No. 2003-51, 109(15C)

Eliot I Bernstein

From: Eliot I Bernstein [res0bf4a@verizon.net]
Sent: Tuesday, October 23, 2001 8:16 PM
To: John D. Calkins (E-mail); Clarissa C. Weirick (E-mail); David J. Colter (E-mail); David J. Colter (E-mail 2)
Subject: I View It
Importance: High
Sensitivity: Confidential



John and Clarissa,

Attached are the projections done by the company. After further discussion with Aidan I am unclear if he will be forwarding you the plan he worked up with our investor Crossbow. I will forward under separate cover, Aidan's plan, although he password protected it and only gave the passwords to the Crossbow group, you may call him at 213.952.7338 to get the passwords. I will attach another version that the Company has worked on that assumes that our creditors and lenders will convert debt to equity and release their securitization upon investment. The balance sheet is left very clean if I can get agreement and most of these people are my advisors and friends and have already agreed. I can have a letter stating such from all concerned parties in the 6 weeks of your review. At our Board meeting one of our largest lenders agreed to convert @350k and all the board member note holders will also convert. I have requested Crossbows position on their notes. Two of the law firms, Armstrong Hirsh and Irell will take an equity stake for most of their bill. I have not contacted the other largest creditor Proskauer Rose but being an advisor that has equity we anticipate their cooperation. The next largest creditor group is our ex-management referred to us by Proskauer and again we see settlement as a high probability.

The Company after this conversion of debt looks rather good and has a very low and manageable overhead, until such time as the patents would award, estimated 6 months.

The patent documents in their entirety will be delivered tomorrow. I am unsure if Aidan will be asking Crossbow the questions regarding their position, but if he is unwilling I will certainly go find out myself, while scrambling for new management.

Now the funny part. Aidan was to have a business plan prepared for Heidi months ago. We have no such plan from him, but I did work on one. It is in rough draft form and missing the financials but most of that will be in this plan attached, it least it gives a general idea of the license model and markets for the technologies. With a little R&D money most of those markets could be quickly evaluated.

As you know, Ken Rubenstein of Proskauer Rose who you mentioned may opine for you on these patent matters is as a partner of Proskauer Rose and as such, a shareholder of I View It, and the first guy to really see the patents. He is a litigator and had just moved to Proskauer from Meltzer Lippe Goldstein, and he referred us to Meltzer for our provisional filings, he has been overseeing the patent pool since that first point of invention and has spoken for the Company to Greg and

4/27/2003



Lorraine Christine Hoffman, Esq.
Assistant Staff Counsel
The Florida Bar
File No. 2003-51, 109(15C)

Page 2 of 3

many others on behalf of the company's novel products.

I have also attached the letter done by Blakely, Sokoloff, Taylor & Zafman, LLP, regarding their assessment of the patent portfolio. Open that file with the Imaging program in your accessories or you won't be able to see all the pages (save 2001 08 01 opinion.tif first in My Docs then Start, Programs, Accessories, Imaging, then file open, go to tif file).

If you have the need for any additional documents to help in your due-diligence, please feel free to call me at 310.265.1730 or 310.600.4645. I will have the corporate documents ready within the week that pertain to our loans with investors, etc. Sorry this is all a bit disordered but a funny thing happened to me on the way to Virginia.

I want to extend my deepest respect to you both for helping me through this situation and for your understanding.

Documents attached;

I View It Technologies Restructuring Plan.doc,
Restplan03.xls Sheets
Capcht - I View It Holdings Cap table
Capchttech.xls - I View It Technologies Cap Table
Financial Stmts.xls
2001 08 01 Opinion.tif
2001 08 20 Business Plan

Best regards,

Eliot

Eliot I. Bernstein
Founder & Vice Chairman
eliot@iviewit.com

I-View-It Technologies, Inc.
505 North Brand Boulevard
Suite 1420
Glendale, CA 91203-2308

Voice: 818.545.1444
Fax: 818.545.1440
Cell: 310.600.4645
Home\Work: 310.265.1730
www.iviewit.com

Blessed are the geek: for they shall inherit the earth! Gatthew 5:5

NOTE: This e-mail transmission, and any documents, files or previous e-mail messages attached to it may contain confidential information that is legally privileged. If you are not the intended recipient, or a person responsible for delivering it to the intended recipient, you are hereby notified that any disclosure, copying, distribution or use of any of the information contained in or attached to this transmission is STRICTLY PROHIBITED and not very polite. If you have received this transmission in error, please immediately notify us by reply e-mail or by telephone at (818) 545-1444 and destroy the original transmission and its attachments without reading or saving in any manner or just format your hard drive.

Incoming mail is certified Virus Free.

4/27/2003



Lorraine Christine Hoffman, Esq.
Assistant Staff Counsel
The Florida Bar
File No. 2003-51, 109(15C)

Further evidence from Mr. Rubenstein deposition testimony will point to multiple perjured statements as after reviewing the prior evidence will become apparent.



Lorraine Christine Hoffman, Esq.
Assistant Staff Counsel
The Florida Bar
File No. 2003-51, 109(15C)

25

2 Q. Do you have any information at all
3 with regard to any of the IViewIt entities?
4 A. Not at this time, no.
5 Q. "Not at this time." Did you have
6 any information at any time in the past, sir?
7 A. Not that I know of right now.
8 Q. Do you have any files or records
9 indicating that you had any dealings with --
10 and I will go through a list here --
11 IViewIt.com, Inc.?
12 A. Not that I know of.
13 Q. IViewIt, LLC?
14 A. Not that I know of.
15 Q. UViewIt?
16 A. Not that I know of.
17 Q. IViewIt, Inc.?
18 A. Not that I know of.
19 Q. Have you ever heard of an
20 individual named Eliot Bernstein?
21 A. I might have.
22 Q. Well, sir, that's either a "Yes"
23 or "No" question.
24 A. Like I said, I think he works for
25 IViewIt, and I may have heard his name.

And further



Lorraine Christine Hoffman, Esq.
Assistant Staff Counsel
The Florida Bar
File No. 2003-51, 109(15C)

6 Q. How about Warner Bros.?
7 A. Warner Bros. is a client here.
8 Q. Okay. Did you have any
9 discussions with Warner Bros. about IViewIt?
10 MR. PRUSASKI: Objection.
11 A. Any --
12 MR. PRUSASKI: Instruct him not to
13 answer.
14 (DIRECTION NOT TO ANSWER.)
15 A. Any conversation I made or had
16 with Warner Bros. would be confidential. I am
17 not saying there was or was not such a
18 conversation, it would be privileged.
19 Q. I am not asking you for the
20 contents of the conversation, I want to know
21 if there was one.
22 A. I am not saying -- I don't know if
23 there was one.
 And if there was, I wouldn't tell
 you about it, anyway.

And further in his deposition



Lorraine Christine Hoffman, Esq.
Assistant Staff Counsel
The Florida Bar
File No. 2003-51, 109(15C)

7 Q. The question was, did you ever
8 discuss any matters concerning IViewIt with
9 anyone from Warner Bros., period. I am not
10 asking you for the content because, clearly,
11 if you want to assert a claim of privilege on
12 that, and Warner Bros. is a client of yours,
13 then you can assert it, but I am asking you
14 whether or not you had any discussions at
15 all. I am not asking you for the contents.
16 A. I am --
17 MR. PRUSASKI: Mr. Selz, I am
18 going to object. I am instructing
19 Mr. Rubenstein not to answer. It's
20 privileged attorney/client
21 communication.
22 (DIRECTION NOT TO ANSWER.)
23 MR. SELZ: Not the fact of whether
24 or not he had any discussions --
25 MR. PRUSASKI: I am not arguing.
29
1 Rubenstein
2 We are not allowed, under the Florida
3 rules, to argue objections. I am
4 instructing him not to answer.
5 MR. SELZ: I understand.
6 MR. PRUSASKI: And I can't argue
7 with you.
8 MR. SELZ: Just so the record is
9 clear, your objection is it's
10 privileged, whether or not he even spoke
11 to Warner Bros.
12 MR. PRUSASKI: Yes, about IViewIt.
13 MR. SELZ: About IViewIt.
14 MR. PRUSASKI: Yes.
15 Q. Do you know who Greg Thagard is?
16 A. Yes, I do.
17 Q. Who is he?
18 A. He used to work at Warner Bros.
19 Q. He doesn't work with Warner Bros.
20 anymore; is that correct?
21 A. Correct.
22 Q. When did you represent Warner
23 Bros., sir?
24 A. Oh, that's not -- that's
25 privileged information, sorry.
30
1 Rubenstein
2 MR. PRUSASKI: I am going to
3 object for relevancy, and instruct the
4 witness not to answer. It's also
5 privileged.
6 (DIRECTION NOT TO ANSWER.)
7 MR. SELZ: I don't think case law
8 supports the position that when he
9 represented a client --
10 MR. PRUSASKI: Are we going to



Lorraine Christine Hoffman, Esq.
Assistant Staff Counsel
The Florida Bar
File No. 2003-51, 109(15C)

11 argue every time there is an objection?

12 MR. SELZ: No, no, no.

13 A. We will litigate out the issue.

14 We will litigate it out. You know, make a

15 motion. We will fight it. We will see who

16 wins.

17 Q. Mr. Rubenstein again, you know,

18 this is your deposition --

19 A. I don't --

20 Q. -- I appreciate the fact that you

21 want to express your opinion. However,

22 Mr. Prusaski can tell you, this is not how

23 depositions are conducted in the State of

24 Florida.

25 A. Fine. I am not discussing

31

1 Rubenstein

2 anything about Warner Bros. The objection has

3 been put on the record. Let's move on.

4 MR. PRUSASKI: And, Mr. Selz, just

5 to make it clear, I am going to instruct

6 the client not to answer any questions

7 about any Proskauer clients under claim

8 of privilege and under claim of

9 harassment and under claim of the fact

10 that you are not allowed to put any of

11 this on at trial.

12 MR. SELZ: Well --

13 MR. PRUSASKI: And we can litigate

14 that with Judge Labarga.

Again on this point from his deposition:



Lorraine Christine Hoffman, Esq.
Assistant Staff Counsel
The Florida Bar
File No. 2003-51, 109(15C)

17 Q. How about any awareness on your
18 part of any IViewIt inventions regarding zoom
19 imaging?
20 A. I have no knowledge at this point
21 in time of IViewIt technology.
22 Q. So you have no knowledge of scaled
23 video?
24 A. I didn't say that. I said I have
25 no knowledge of what IViewIt technology is at
33
1 Rubenstein
2 this point in time.
3 Q. Okay, why don't you explain to me
4 "scaled video", to the best of your
5 knowledge.
6 A. I don't know what you mean by
7 "scaled video".
8 Why don't you explain to me what
9 you are talking about.
10 Q. Well, what does that mean to you?
11 You seemed to indicate earlier in your answer
12 that you had some idea of what I was talking
13 about.
14 A. Well, "scaled video" might refer
15 to changing the sizes of video images.
16 Q. And how is that accomplished?
17 A. I don't know. At this point in
18 time, I am sure there is a variety of
19 techniques to do it.
20 Q. Are you aware of any such
21 techniques that IViewIt was using?
22 A. No.
23 Q. Are you aware of any camera zoom
24 applications used in the IViewIt technology?
25 A. No.
1 Rubenstein
2 Q. How about combined scaled video
3 zooming video applications?
4 A. Not that I know of.
5 I am not saying they don't or do
6 exist, I am saying I don't know.
7 Q. Of course, it's to the best of
8 your knowledge, sir, I am not expecting you to
9 be on omniscient.
10 How about game applications?
11 A. I have no knowledge of what
12 IViewIt's doing.
13 Q. How about what they have done in
14 the past?
15 A. I have no knowledge of what they
16 have done in the past at this point in time.
17 Q. Is it that you have no knowledge
18 or you can't recall?
19 A. I don't know if I knew in the past
20 or didn't know in the past, I don't know now.
21 Q. So, in other words, sir, you have





Lorraine Christine Hoffman, Esq.
Assistant Staff Counsel
The Florida Bar
File No. 2003-51, 109(15C)

22 no knowledge as to any technology that IViewIt
23 uses; is that correct?

24 A. At this point in time, that is
25 correct.

35

1 Rubenstein

2 Q. Did you have such knowledge in the
3 past?

4 A. I don't know whether I did or did
5 not, I don't know now.

6 Q. So, then, sir, you wouldn't have
7 any ability to know whether or not any of your
8 clients are using IViewIt technology; is that
9 correct?

10 A. I would have no idea.

One more that illustrates the continued harassing attacks on Mr. Bernstein who is simply an observer telephonically of the deposition.



Lorraine Christine Hoffman, Esq.
Assistant Staff Counsel
The Florida Bar
File No. 2003-51, 109(15C)

19 Q. Do you know of any patenting of
20 inventions for IViewIt?

21 A. Like I say, I was not involved as
22 their patent counsel, other people served as
23 their patent counsel.

24 Q. Are you aware of any of the
25 particulars of any of those patents?

Rubenstein

2 A. I was not --

3 MR. PRUSASKI: This --

4 A. I will repeat it again, I was not
5 involved as their patent counsel, other people
6 were. And, at this point in time, I have no
7 knowledge of their patent applications.

8 MR. PRUSASKI: Mr. Selz, you are
9 repeating yourself now.

10 MR. SELZ: I'm sorry, Chris.

11 MR. PRUSASKI: Eliot needs to type
12 some new questions.

13 A. Maybe he didn't get a good night's
sleep.

And further in his deposition



Lorraine Christine Hoffman, Esq.
Assistant Staff Counsel
The Florida Bar
File No. 2003-51, 109(15C)

- 4 Q. I had asked you previously, sir,
5 whether or not you had any information on
6 Mr. David Colter.
7 Do you recall that?
8 A. Yes, and I said I wasn't sure who
9 he was, and I suggested you might want to
10 refresh my recollection, and you declined to
11 do so.
12 Q. Okay. Would it refresh your
13 recollection, sir, if I tell you that
14 Mr. Colter was with Warner Bros.?
15 A. You know, I may have heard the
16 name, but I don't think I ever had any
17 dealings with him, although I am not sure.
18 Q. But you do have dealings with
19 Warner Bros.; is that correct?
20 A. Like I said, Warner Bros. is a
21 client.
22 Q. Right. Would there be any reason
23 why your name would be mentioned in E-mails,
24 that you can think of, from Warner Bros. to
25 someone at AOL?
69
1 Rubenstein
2 A. I don't know.
3 I mean, I do work -- they are part
4 of the same company, they are clients of the
5 firm, and so, I can't really discuss it
6 because of privilege.
7 Q. Sir, you had indicated earlier you
8 had no idea with regard to any of the
9 intellectual properties or patents for
10 IViewIt; is that correct?
11 A. Not at this point in time.
12 Q. Did you ever issue any opinion to
13 anyone as to the validity of those patents?
14 A. Not that I know of.
15 Q. Did you ever provide any
16 information at all with regard to the validity
17 of any of these patents?
18 A. Not that I know of.
19 Q. So it's possible that you have in
20 the past but you don't recall?
21 A. I don't recall having involvement
22 with these patents. I was not the patent
23 counsel.



Lorraine Christine Hoffman, Esq.
Assistant Staff Counsel
The Florida Bar
File No. 2003-51, 109(15C)

Mr. Rubenstein when sequestered to appear under deposition in the Proskauer Rose billing case was presented to the court by Respondent as someone who did not know Iviewit at all and thus should not be deposed. I think after reading his deposition and the submitted evidence the Florida Bar will find this a complete joke fraught with perjury, lies and deceit and that he had full knowledge of the Company, who the inventors were, who the investors were, what the patents were and there applications to all forms of imaging and video.

IX. Billing statements that refute that Proskauer Rose and Mr. Wheeler's and Rubenstein's claims that they handled no patent matter or matters relating to Iviewit's patents such as Patents, Copyrights and License Agreements.

Billing statements are evidenced below, and again we urge the bar to get the complete records of paid bills to fully understand the scope and degree of the patent work done by Proskauer Rose, and we submit a sample of billings done by Proskauer in relation to the patents.

Since the billings reflect unpaid invoices only and approximately 300-400,000 of bills were paid, we are missing quite a few invoices that have been completely destroyed from the corporate records. You will also note deposition testimony from Rubenstein and Wheeler in which neither can remember what any of the following patents entries with their names on the billing are in regard to.

We submit the following as evidence regarding the billings for patent work, this is a small sample of patent bills for Rubenstein and Wheeler and in light of their statements that they did NO patent work, it is remarkable. Also, of note again, we have only been presented with a fraction of the total billings for the Company as the paid invoices, which presumably would have paid for the earliest invoices, is missing and was not in the documents provided by Proskauer under court order. Thus, again we urge the Florida Bar to demand the complete billings to assess the magnitude of the true amounts of patent work completed by Proskauer Rose and their 20 attorneys. It is also of note that although Mr. Rubenstein is attending numerous conferences, he never bills a single minute of work as a partner, the only Proskauer partner of 20 to work for free. It is also of note that Mr. Wheeler is consistently attending meetings and conferences and giving patent advice when he is not a registered patent attorney. It is also of note that the Proskauer footers are missing on the bills submitted to the Bar of Florida for the periods of 1/99 through 1/00, periods the Company claims the bills have been altered, as it is on every Proskauer bill forward, we feel that this missing footers also may indicate document tampering as all Proskauer documents are stamped with the account numbers and footers at the bottom.



Lorraine Christine Hoffman, Esq.
Assistant Staff Counsel
The Florida Bar
File No. 2003-51, 109(15C)

The Bar should also take note that in the August 24, 1999 billing submitted to the Bar that on page 2 of the bill a billing occurs for a 2 hour meeting in 12/09/98 and the next billing in the record is for 6/1/99. This billing appears very strange indeed and contradicts Mr. Wheelers statements to the Bar that Proskauer did not start work until 1999. It is the Company's contention that Proskauer started working with the Company earlier in 1998 and these billing records are missing or destroyed.

The Bar should also take note that although Iviewit was billed for Copyrights and was under the assumption that Copyrights of the proprietary source codes and websites had been filed as provided to Proskauer Rose, that there are no Copyrights on file for the Company.

From Mr. Wheeler's response to the Florida Bar:

Finally, it should be noted that Proskauer's invoices also confirm that Proskauer did not perform patent work. Rather, Proskauer's role was limited to referring the patent work to other law firms. Thus, regardless of whether Mr. Bernstein is pleased or displeased with the patent-related services provided to Iviewit, Proskauer simply did not provide those services. In short, Mr. Bernstein's accusations that Proskauer somehow performed patent work at all, much less performed patent work improperly, is demonstrably false.

The following billings are composed of billings for either direct patent and copyright work, licensing of the patents, which should have been handled by licensed Patent attorneys and other billings having to do with opinions of the patents for investors. What we have not included are the enormous billings for frivolous trademarks that provide no protection to the Company and we urge the Bar of Florida to review the bills to see that all of this Trademark work was directed by Wheeler to hide the fact that he was supposed to be securing Copyrights for the Source Codes, Websites and Business plans of which the Company was billed for by Proskauer Rose but never were applied for. The Bar will also note that Mr. Joao's name does not appear until the end of March 1999, months after Mr. Rubenstein was reviewing and supposedly securing patents for the Company.

It is most remarkable to note that although Mr. Rubenstein's name is repeated throughout the bill and he is on call after call opining on the patents for various reasons, he is the ONLY Proskauer Rose partner NOT to bill a single minute of his time. Please remember that we are also missing many bills that Proskauer has provided to no one and that these may contain further patent and Rubenstein billings. The reason Mr. Rubenstein does not bill is an attempt to claim that he was not involved for if were, the Conflicts of Interests for the clients he represents, currently using the Iviewit processes would be enormous.



Lorraine Christine Hoffman, Esq.
Assistant Staff Counsel
The Florida Bar
File No. 2003-51, 109(15C)

Also of note is that over and over again in these billings you will find that Wheeler is opining for investors which he later claims is only on corporate matters and yet several million dollars were secured based on the opinions and Raymond Joao never once bills for any review to any investor. Who then did the opinions on the patents for the investors if it was neither Rubenstein nor Joao?

Also, it should be noted that Mr. Rubenstein was represented as an overseer of Mr. Joao's filing work and was to be used mainly for later litigation of the patents and to seduce investors as his opinion was essential, so his time was not extensive but yet critical.



Lorraine Christine Hoffman, Esq.
Assistant Staff Counsel
The Florida Bar
File No. 2003-51, 109(15C)

119

01/14/99 C WHEELER	.50	Follow up on status on intellectual property review and new incorporation
01/26/99 M ROBBINS	1.75	Revisions to Articles of Incorporation. Inter-office conference with Foster re: filing of Articles. Telephone conferences with Healy re: trademark and copyright matters. Preparation of memorandum to Wheeler re: same.
01/26/99 G GOLDMAN	1.00	Reviewing IVIEWIT's business plan for patentability opinion; conducting an on-line Internet search.
01/27/99 M ROBBINS	1.75	Preparation of correspondence to Bernstein. Review corporate formation documents from Secretary of State. Telephone conference with Bernstein. Preparation of memorandum to Wheeler re: intellectual property matters.
01/28/99 A GORTZ	.75	Ken Rubenstein call, cf call Eliot Bernstein & Ken Rubenstein, cf Mara Robbins re confidentiality agreement
02/01/99 C WHEELER	.25	Conf as to status of intellectual property work
01/27/99 M ROBBINS	1.75	Preparation of correspondence to Bernstein. Review corporate formation documents from Secretary of State. Telephone conference with Bernstein. Preparation of memorandum to Wheeler re: intellectual property matters.
01/28/99 A GORTZ	.75	Ken Rubenstein call, cf call Eliot Bernstein & Ken Rubenstein, cf Mara Robbins re confidentiality agreement
02/01/99 C WHEELER	.25	Conf as to status of intellectual property work
02/16/99 C WHEELER	.25	Conf with Mr. Bernstein; call to Mr. Rubenstein
02/17/99 C WHEELER	.25	Call to Mr. Rubenstein re patent advice; call with Ms. Coleman re financial advisor
02/18/99 C WHEELER	1.50	Conf with Mr. Lewin; follow up on Corp.; follow up on copyright; follow up on
02/18/99 C WHEELER	.25	Conf with Mr. Rubenstein
02/18/99 M ROBBINS	2.50	Inter-office conference with Wheeler re: intellectual property matters, organizational matters. Revisions to Bylaws, Organizational Minutes. Inter-office conferences with Gardner re: employer identification number, minute book. Draft and preparation of correspondence to Bernstein re: copyright and trademark searches, fees and costs. Review memorandum for Wheeler re: organizational matters.



Lorraine Christine Hoffman, Esq.
Assistant Staff Counsel
The Florida Bar
File No. 2003-51, 109(15C)

02/22/99 M ROBBINS	1.50	Draft and preparation of correspondence to Bernstein re: copyright and trademark matters. Inter-office conference with Wheeler re: organizational matters. Inter-office conferences with Gardner re: issuance of stock certificates, Fictitious Name Application.
02/23/99 C WHEELER	.25	Review of correspondence re patent matters
03/03/99 G COLEMAN	.50	Telephone conferences with E. Bernstein and I. Newman. Preparation of final document.
03/16/99 C WHEELER	1.00	Call to Mr. Bernstein; conf with Mr. Lewin; check status of trademark and copyright;
03/16/99 M ROBBINS	.50	Inter-office conference with Wheeler re: intellectual property matters.
03/23/99 C WHEELER	.50	Conf with Mr. Bernstein re private placement over the Internet and re copyright follow up
03/23/99 A GORTZ	.25	Simon & Eliot conf call; conf CCW.
03/24/99 C WHEELER	.50	Call to Mr. Lewin; conf with Mr. Healey re copyright; conf with patent counsel
03/29/99 K HEALY	1.25	Tc w/C. Wheeler; tcs w/Eliot Bernstein re intellectual property protections; tc w/Raymond Joao re patent pending; tcs w/E. Bernstein and Jerry Levin re license business models; review protectability of web-sites
03/30/99 K HEALY	1.00	Tc w/E. Bernstein and J. Levin re licensing structures for Iviewit; tc w/C. Wheeler
03/31/99 K HEALY	.25	Tc w/K. Rubenstein re Patent advice
04/07/99 C WHEELER	.25	Conf with Mr. Gortz; call to Mr. Healey
04/08/99 K HEALY	.75	Copyright: Review CD-ROM; advise E. Bernstein on copyright protection matters
04/14/99 K HEALY	.75	Review Authorization and release; review procedures for copyright registrations of collections; conference call w/E. Bernstein, J. Lewin and G. Reed; draft file memo
04/14/99 C WHEELER	1.00	Conf with Mr. Rossman; conf with Mr. Lewin; revise confidentiality agreement;
04/21/99 C WHEELER	1.00	Conf with Mr. Stanley; Conf with Mr. Stanley and Mr. Bernstein;
04/22/99 K HEALY	.25	Tc w/R. Joao; e-mail to E. Bernstein
04/26/99 C WHEELER	1.00	Rewrite Iviewit letter
04/29/99 C WHEELER	1.00	Conf with Kevin Healey; conf with Mr. Bernstein and Mr. Lewin re shares



Lorraine Christine Hoffman, Esq.
Assistant Staff Counsel
The Florida Bar
File No. 2003-51, 109(15C)

03/11/99 K HEALY .25 TC w/ K. Rubenstein re Patent Advice

This states 3/11/99 K Healy - .25 TC w/ K. Rubenstein re Patent Advice



Lorraine Christine Hoffman, Esq.
Assistant Staff Counsel
The Florida Bar
File No. 2003-51, 109(15C)

04/29/99 C WHEELER .50 Conf with Mr. Stanley; call to Mr. Lewin

04/30/99 C WHEELER .25 Confirm appointment with Real 3D

05/03/99 K HEALY 1.50 Review Iviewit Business Plan for IP Issues;
draft suggested revisions to business plan

05/03/99 C WHEELER .25 Revise Confidentiality Agreement; arrange
transmission; conf with Mr. Rossman

05/06/99 C WHEELER .25 Tel conf as to meeting

05/07/99 C WHEELER 3.00 Meeting on agreements and other corporate
matters

05/10/99 C WHEELER 2.00 Meeting with Mr. Stanley; conf with Messrs.
Lewin and Bernstein

05/12/99 C WHEELER 1.00 Conf with Messrs Bernstein and Lewin; call to
R. João; transmittal of agreement

05/12/99 C WHEELER .50 Conf with Mr. Joao re stock ownership,
subsidiary and patent protection

05/12/99 C WHEELER 2.00 Conf with Joao; meeting with Thompson to
arrange for confid. agreements and generic
agreements

05/17/99 J SILVER 1.00 2 calls with Kevin Healy re: model website
agreements, call with Mara Robbins re: website
agmts, review agmts for use in connection with
website development deal

05/17/99 M ROBBINS 2.00 Revisions to letter agreement. Telephone
conference with Wolf re: website agreement.
Inter-office conference with Thompson re:
website agreement. Telephone conference with
Healy and Silver re: website agreement. Review
sample website agreements. Inter-office
conferences with Zamas re: Articles of
Amendment and Organizational Consent.

05/18/99 D THOMPSON II 3.50 Conference with paralegal Jill Zamas re
Articles of amendment authorizing new Class of
Stock; review and revise same; analysis of
potential loan program; Website.

05/18/99 C WHEELER .25 Review of Iviewit matters



Lorraine Christine Hoffman, Esq.
Assistant Staff Counsel
The Florida Bar
File No. 2003-51, 109(15C)

05/18/99 M ROBBINS 5.00 Inter-office conferences with Thompson re: technology evaluation agreement. Preparation of correspondence to Wolf re: license evaluation agreement. Draft and preparation of license evaluation agreement. Meeting with Bernsteins re: letter agreement, license evaluation agreement. Inter-office conferences with Zannas re: Organizational Consent and Articles of Amendment. Inter-office conferences with Thompson re: Articles of Amendment and share issuances. Telephone conference call with Thompson and Rowe re: whether issuance of note is a security. Computer research re: technology license agreements. Review model website development agreements. Review CD-ROM Licensing Agreement. Telephone conferences with Bernstein re: launch of website and review of website. Telephone conferences with Wolf re: potential issues relating to website launch. Telephone conferences with Silver re: technology agreements.

05/18/99 J SILVER 1.75 Call with Mara Robbins re: website agmt, arranged for form agreement to be scanned into the system, e-mailed scanned document to Mara, phone call with Mara re: obtaining additional technology form license agreements, review form books in library for additional technology license agmts, phone call with Mara re: CD-ROM agmt and fax agmt to Mara

05/18/99 M ROBBINS 5.00 Inter-office conferences with Thompson re: technology evaluation agreement. Preparation of correspondence to Wolf re: license evaluation agreement. Draft and preparation of license evaluation agreement. Meeting with Bernsteins re: letter agreement, license evaluation agreement. Inter-office conferences with Zannas re: Organizational Consent and Articles of Amendment. Inter-office conferences with Thompson re: Articles of Amendment and share issuances. Telephone conference call with Thompson and Rowe re: whether issuance of note is a security. Computer research re: technology license agreements. Review model website development agreements. Review CD-ROM Licensing Agreement. Telephone conferences with Bernstein re: launch of website and review of website. Telephone conferences with Wolf re: potential issues relating to website launch. Telephone conferences with Silver re: technology agreements.

05/19/99 D THOMPSON II .75 Prepare Technology/Software Evaluation Agreement.

05/19/99 D THOMPSON II .50 Follow-up re website release.



Lorraine Christine Hoffman, Esq.
Assistant Staff Counsel
The Florida Bar
File No. 2003-51, 109(15C)

05/19/99 M ROBBINS 5.00 Draft and preparation of Technology License Evaluation Agreement. Inter-office conference with Thompson re: Technology License Evaluation Agreement, amendment to Articles, issuance of shares and notes and meeting with Bernsteins. Preparation of e-mails to Healy and Wolf re: website launch. Meeting with S. Bernstein, E. Bernstein and Lewin. Inter-office conferences with Zammass re: filing of articles of amendment and letter agreement re: share issuances. Telephone call to Lewin re: confirmation of share amounts. Preparation of letter agreement. Calculation of share issuances.

05/20/99 C WHEELER .75 Conf with Mr. Joao ↓

05/20/99 C WHEELER → 2.00 Call to Mr. Lewin; conf with Ken Rubenstein; conf with Mara Lerner; numerous conf with Elliot Bernstein

05/20/99 C WHEELER 1.00 Conf with Mr. Joao

05/20/99 M ROBBINS 6.50 Telephone conference call with E. Bernstein and K. Healy. Telephone conference call with E. Bernstein and C. Wolf. Telephone conferences with E. Bernstein re: website review. Review Iviewit website. Telephone conference call with Thompson and E. Bernstein re: License Evaluation Agreement. Preparation of License Evaluation Agreement. Inter-office conferences with Zammass re: letter agreements to issue shares. Preparation of packages to shareholders. Draft and preparation of Subscription Letter Agreement re: issuance of promissory note. Telephone call to Lewin re: Note terms. Review License Evaluation Agreement. Computer research re: license evaluation agreements. Telephone conference with Court re: License Evaluation Agreement. Inter-office conferences with Thompson re; License Evaluation Agreement. Organization of Iviewit file.

05/21/99 M ROBBINS 4.00 Draft and preparation of promissory note. Telephone conferences with Lewin. Telephone conferences with E. Bernstein. Telephone conferences with Lohquist re: License Evaluation Agreement. Organization of corporate files. Revisions to Subscription Letter Agreement.

05/21/99 D THOMPSON II 1.25 Prepare Confidentiality Agreement with Huizenga Holdings; Telephone conference with counsel for Huizenga re same; Conference with Attorney C. Wheeler re Real 3D Confidentiality Agreement.

05/21/99 C WHEELER .25 Conf with Mr. Bernstein re meeting



Lorraine Christine Hoffman, Esq.
 Assistant Staff Counsel
 The Florida Bar
 File No. 2003-51, 109(15C)

05/21/99 M ROBBINS 4.00 Draft and preparation of promissory note. Telephone conferences with Lewin. Telephone conferences with E. Bernstein. Telephone conferences with Lohquist re: License Evaluation Agreement. Organization of corporate files. Revisions to Subscription Letter Agreement.

05/24/99 C WHEELER 1.50 Meeting with Hassan Mia

05/25/99 C WHEELER 11.00 Trip to Orlando for meeting with Real 3D technology staff

05/26/99 C WHEELER 1.00 Review of patent; set up patent conference; arrange follow up on shares;

05/26/99 K HEALY .75 Tc w/M. Lerner re Iviewit i.p. ownership issues, including assignment or license from Eliot Bernstein to Iviewit; review web-site materials

05/27/99 C WHEELER 1.50 Overview of Iviewit patent matters and corporate matters

05/28/99 D THOMPSON II 1.25 Conference with Attorney C. Wheeler re patents and confidentiality agreements; assist re same.

05/28/99 C WHEELER .50 Confirmation on Joao meeting

05/28/99 C WHEELER 2.00 Meeting as to patent issues and management matters

05/28/99 C WHEELER .50 Conf. w/K.Rubenstein

05/28/99 K HEALY .50 Tcs w/C. Wheeler re IP Issues; review web-site

05/31/99 C WHEELER 1.00 Review of patent and other materials

We submit the following page in full as after the prior bill this bill is the next bill in 8/99 and has a 1008 billing attached to it?

PAGE: 18

05/27/99 C WHEELER .50 Conf with Mr. Rubenstein



Lorraine Christine Hoffman, Esq.
 Assistant Staff Counsel
 The Florida Bar
 File No. 2003-51, 109(15C)

CLIENT: IVIEWIT CORPORATION August 24, 1999
 MATTER: GENERAL CORPORATE ADVICE
 PAGE: 2

Suddenly a 12/98 billing, then 6/1/99

DATE	NAME	HOURS	DESCRIPTION
12/09/98	C WHEELER	2.00	Meeting as to corporate setup and new product
06/01/99	I AKSELRAD	.50	Tel w/CW & JL re tax structure
06/01/99	A GORTZ	.25	Cf CCW
06/01/99	D THOMPSON II	.25	Conference with Attorney Mara Lerner Robbins re employment agreement issues.
06/01/99	C WHEELER	4.00	Conf with Mr. Rubenstein; conf with Mr. Lewin; conf with Mr. Healy; conf with Mr. Joao; conf with Mr. Akselrod re patents, tax ramifications, copyright work;
06/01/99	K HEALY	1.50	Conference call w/E. Bernstein, R. Joao, K. Rubenstein, C. Wheeler, and others re iviewit I.P. issues; review cd.rom
06/01/99	M ROBBINS	.50	Inter-office conferences with Zamas re: received Subscription Letter Agreements (Notes) and Letter Agreements (Common Stock). Inter-office conference with Wheeler re: retention of Letter Agreements (Notes). Inter-office conferences with Thompson re: employment agreements.
06/01/99	J ZAMMAS	1.00	Preparation of letter to Eliot Bernstein regarding Subscription Letter Agreements; issue shares of iviewit.com, Inc. to iviewit, Inc.;
06/02/99	R ROWE	.25	Rev. finders issue
06/02/99	D THOMPSON II	.75	Correspondence re Finder's Fees Agreement with Attorney Gayle Coleman; Telephone conference re employment agreement issues.
06/02/99	C WHEELER	1.50	Lengthy conference with Mr. Bernstein and Mr. Lewin
06/02/99	K HEALY	.25	FIXED FEE: Review Confidentiality Agmt.
06/02/99	G COLEMAN	2.00	Draft and preparation of employment agreement. Telephone conference with E. Bernstein re McKenzie agreement.

12/09/98 C WHEELER 2.00 Meeting as to corporate setup and new product



Lorraine Christine Hoffman, Esq.
Assistant Staff Counsel
The Florida Bar
File No. 2003-51, 109(15C)

06/01/99 C WHEELER	4.00	Conf with Mr. Rubenstein; conf with Mr. Lewin; conf with Mr. Healy; conf with Mr. Joao; conf with Mr. Akselrod re patents, tax ramifications, copyright work;
06/01/99 K HEALY	1.50	Conference call w/E. Bernstein, R. Joao, K. Rubenstein, C. Wheeler, and others re iviewit I.P. issues; review cd.rom
06/03/99 C WHEELER	2.00	Call to Mr. Joao; call to Mr. Healy; conf with Mr. Bernstein; review of numerous correspondence; conf with Mr. Lewin
06/04/99 C WHEELER	2.00	Prep of revised confidentiality agreement; call to Ms. Bibona; conf with Mr. Joao;
06/04/99 C WHEELER	1.50	Conf with Mr. Bernstein re confidentiality agreements and re Real 3-D; message from Ms. Bibano; Message from Mr. Brandon
06/09/99 C WHEELER	1.00	Conference w/Mr. Rosman re revision; arrange revision
06/09/99 C WHEELER	.25	Set up conference call w/Rosalie Bibona
06/09/99 C WHEELER	.50	Conference w/R. Bibona
06/10/99 C WHEELER	5.00	Conf with Mr. Bernstein; conf with Mr. Lewin; set up meeting with Huizinga group; Conf with Mr. Bernstein; conf with tax counsel; conf with Mr. Epstein
06/14/99 C WHEELER	2.50	Two conferences w/R. Bibona
06/14/99 C WHEELER	.50	Conference w/Mr. Kane
06/14/99 C WHEELER	.25	Immigration matter
06/15/99 C WHEELER	.50	2 Conf with Mr. Kane; call to Ms. Bibona
06/15/99 C WHEELER	.75	Conf with Mr. Kane and Ms. Bibona; conf with Mr. Bernstein
06/16/99 C WHEELER	4.00	Meeting with Mr. Joao and Messrs. Bernstein re patent and other matters
06/16/99 S ROMOFF	2.25	Telephone conference w/ DT and G. Lewin; Revise LLC Agreement and send draft G. Lewin; Research basis in patent.
06/17/99 C WHEELER	.50	Call to Mr. Kohner of Arthur Anderson; call to Ken Rubenstein
06/17/99 C WHEELER	.50	Follow up on Rossman and O'Donnell disclosures
06/17/99 C WHEELER	2.50	Meeting with Mr. Selman, Mr. Bernstein, Mr. Lewin



Lorraine Christine Hoffman, Esq.
Assistant Staff Counsel
The Florida Bar
File No. 2003-51, 109(15C)

06/18/99 C WHEELER	1.00 Conf with Mr. Bernstein re patents, response of Hassan Miah, Rosalie Bibona and re patent material; conf as to immigration materials;
06/18/99 C WHEELER	3.50 Review of patents with Mr. Joao; conf with Mr. Lewin re status; conf with Mr. Bernstein; Check of status of new corporate documents
06/21/99 C WHEELER	2.50 Numerous conferences w/G.Stanley; numerous conferences w/Simon Bernstein
06/22/99 C WHEELER	3.00 Dictation of notice provision; conf with Mr. Stanley re possible ventures; conf with Rosalie Bibano re participants; conf with Jerry Lewin;
06/23/99 S KAPP	.50 Conf. with CCW regarding various matters pertaining to structure, patents, confidentiality agreements
06/23/99 C WHEELER	.75 Conference w/S.Kapp re immigration; conference as to fee letter for patent counsel; arrange for
06/23/99 J ZAMMAS	.75 Work on foreign qualification documents.
06/24/99 S KAPP	1.00 T/c with Jude Rosario, t/c to Zack S. and t/c to Ron S. PR LLP
06/24/99 S KAPP	.50 T/c with Ray Joao regarding retainer agreement, rvw agreement
06/24/99 S KAPP	.25 F/u regarding assignment of patent issue
06/24/99 C WHEELER	1.00 Check status; arrange for agreement revisions for D. Tel.
06/25/99 S KAPP	.25 T/c with Zack regarding immigration issues
06/25/99 S KAPP	1.00 T/c with Mike Fox at Deutsche Telekom, follow up with E. Bernstein
06/26/99 C WHEELER	.25 Conference w/Mr.Bernstein re Real 3D
06/28/99 S KAPP	.25 Follow up regarding confidentiality agreement with Deutsche Telecom
06/28/99 C WHEELER	1.00 Messages from Rosalie Bibona re proposal and program manager

What's missing





Lorraine Christine Hoffman, Esq.
Assistant Staff Counsel
The Florida Bar
File No. 2003-51, 109(15C)

06/18/99 C WHEELER	1.00 Conf with Mr. Bernstein re patents, response of Hassan Miah, Rosalie Bibona and re patent material; conf as to immigration materials;
06/18/99 C WHEELER	3.50 Review of patents with Mr. Joao; conf with Mr. Lewin re status; conf with Mr. Bernstein; Check of status of new corporate documents
06/21/99 C WHEELER	2.50 Numerous conferences w/G.Stanley; numerous conferences w/Simon Bernstein
06/22/99 C WHEELER	3.00 Dictation of notice provision; conf with Mr. Stanley re possible ventures; conf with Rosalie Bibano re participants; conf with Jerry Lewin;
06/23/99 S KAPP	.50 Conf. with CCW regarding various matters pertaining to structure, patents, confidentiality agreements
06/23/99 C WHEELER	.75 Conference w/S.Kapp re immigration; conference as to fee letter for patent counsel; arrange for
06/23/99 J ZAMMAS	.75 Work on foreign qualification documents.
06/24/99 S KAPP	1.00 T/c with Jude Rosario, t/c to Zack S. and t/c to Ron S. PR LLP
06/24/99 S KAPP	.50 T/c with Ray Joao regarding retainer agreement, rvw agreement
06/24/99 S KAPP	.25 F/u regarding assignment of patent issue
06/24/99 C WHEELER	1.00 Check status; arrange for agreement revisions for D. Tel.
06/25/99 S KAPP	.25 T/c with Zack regarding immigration issues
06/25/99 S KAPP	1.00 T/c with Mike Fox at Deutsche Telekom, follow up with E. Bernstein
06/26/99 C WHEELER	.25 Conference w/Mr.Bernstein re Real 3D
06/28/99 S KAPP	.25 Follow up regarding confidentiality agreement with Deutsche Telecom
06/28/99 C WHEELER	1.00 Messages from Rosalie Bibona re proposal and program manager

What's missing





Lorraine Christine Hoffman, Esq.
Assistant Staff Counsel
The Florida Bar
File No. 2003-51, 109(15C)

07/13/99 C WHEELER 5.00 Meeting with Real 3D reps and Messrs Bernstein;
call to Chris Brandon; transmittal to A.
Epstein

07/14/99 C WHEELER .25 Conf with Mr. Kane

07/19/99 C WHEELER 1.00 Review documentation; review status

07/20/99 S KAPP .25 F/u with GB regarding Deutsche Telekom
agreement

07/23/99 C WHEELER .25 Conf as to assignment issues and follow up on
confidentiality agreement

07/23/99 C WHEELER .25 Check on patent assignment

07/23/99 C WHEELER 2.50 Conf with Mr. Brandon; call to Real3D; conf
with Mr. Bernstein and Mr. Lewin; call to Mr.
Lewin; transmittal to Mr. Brandon

07/23/99 M ROBBINS 3.25 Preparation of correspondence to Alan Epstein.
Revisions to New Media Holdings, Inc.'s
subscription agreement. Inter-office
conferences with Zammas re: status of iviewit
offerings, promissory note issuances, stock
issuances. Inter-office conference with
Wheeler re: assignment of iviewit, Inc.
agreements. Preparation of e-mails to Thompson
and Wheeler re: assignment of iviewit, Inc.
agreements. Preparation of pending matters
memorandum. Telephone conference to Lewin re:
list of loan money received. Telephone
conference with Bernstein re: transfer of
shares to Armstrong. Draft and preparation of
Acknowledgment Agreement. Inter-office
conference with Thompson, Zammas re: transfer
of shares to Armstrong.

07/26/99 C WHEELER 1.00 Conf with Si Bernstein; conf with Mr. Lewin and
Mr. Bernstein; conf with Mr. Utley

07/28/99 C WHEELER 3.50 Conf with Mr. Lewin; conf with Mr. Buchsbaum;
review of corporate status; conf with Mr.
Thompson; review of corres. from Mr. Epstein;
call to Mr. Joao; conf with Mr. Wilson; conf
with Mr. Joao; call to Mr. Lewin

07/29/99 C WHEELER 3.50 Conf with Mr. Utley; meetings with Messrs
Bernstein and Lewin; follow up on transmittal to
Real 3D



Lorraine Christine Hoffman, Esq.
Assistant Staff Counsel
The Florida Bar
File No. 2003-51, 109(15C)

07/31/99 C WHEELER 1.50 Review and organization of various matters involving meetings, venture capital, patents and prospects

08/02/99 S KAPP .50 T/c regarding retainer letter from patent counsel, f/u regarding same

08/02/99 C WHEELER 3.50 Conf with Mr. Brandon; conf with Mr. Bernstein; conf with Elliot Bernstein; conf with Mr. Lewin; conf with Mr. Utley

08/03/99 C WHEELER 1.00 Call to Mr. Kaiserman; conf with Mr. Kaiserman; conf as to assignments

08/03/99 M ROBBINS 5.00 Review file re: assignment of executed agreements. Telephone conferences with Bernstein. Meeting with Lewin re: issuance of additional shares to Armstrong and reduction of Bernstein's shares. Inter-office conferences with Zamas re: reissuance of Armstrong and Bernstein stock certificates and written consent. Inter-office conference with Thompson re: reissuance of Armstrong and Bernstein stock certificates. Revisions to uview.com, Inc. stockholder list. Inter-office conference with Thompson re: assignment of confidentiality agreements. Inter-office conference with Thompson re: Armstrong subscription agreement and issuance of additional shares. Telephone conference with Lewin re: Armstrong additional share issuances. Draft and preparation of correspondence to Bernstein re: revised stock certificates. Inter-office conferences with Zamas re: received subscription agreements. Inter-office conference with Wheeler re: assignment of iviewit, Inc. agreements.

08/04/99 S KAPP .25 T/c with Ray Joao

08/04/99 S KAPP .25 Rvw of retainer letter

08/04/99 S KAPP .25 Rvw modifications to retainer letter

08/04/99 C WHEELER 2.00 Meeting with Mr. Bucshbaum and Mr. Powell; review of Real 3-D Agreement; set up session for Huizinga Holdings

08/04/99 C WHEELER 1.50 Followup on meetings and confidentiality agreements; review of correspondence

08/05/99 S KAPP .25 F/u regarding retainer ltr



Lorraine Christine Hoffman, Esq.
Assistant Staff Counsel
The Florida Bar
File No. 2003-51, 109(15C)

08/05/99 M ROBBINS	1.50 Telephone conferences to Healy re: assignment agreements. Inter-office conferences with Zammas re: stock issuances. Inter-office conference with Wheeler re: Utley employment agreement. Preparation of assignment agreement. Revisions to list of confidentiality agreements. Calculation of Utley shares. Inter-office conference with Thompson re: assignment agreements. Inter-office conference with Wheeler re: assignment agreements.
08/06/99 C WHEELER	1.00 Call to Mr. Brandon; conf with Mr. Bernstein and Mr. Utley
08/11/99 C WHEELER	2.00 Conf with Mr. Bernstein; conf with Mr. Utley; call to Mr. Epstein; brief conf with Mr. Epstein; conf with Mara Lerner re subscription agreements; call to Mr. Henninger re meeting and business plan;
08/10/99 C WHEELER	.50 Review of status of patent material; review of status of employment agreement
08/11/99 M ROBBINS	3.00 Research Delaware corporate statutes re: merger and voting rights. Review received note subscription agreements. Preparation of promissory notes for execution and mailing. Inter-office conferences with Zammas re: preparation of notes and documentary stamps. Preparation of correspondence to E. Bernstein. Inter-office conferences with Zammas re: issuance of promissory notes. Review files re: business plan legend. Revisions to correspondence to E. Bernstein. Inter-office conference with Thompson re: merger and voting rights. Inter-office conferences with Wheeler re: business plan review and intellectual property matters.
08/11/99 C WHEELER	.25 Conf with Mr. Utley re business plan and Real 3D
08/12/99 C WHEELER	.25 Organization of file matters
08/13/99 C WHEELER	.50 Review of status as to Agreement with Real 3D
08/26/99 C WHEELER	.50 Organize patents; conf with Mr. Utley; call on confidentiality agreement
08/27/99 C WHEELER	.50 Conf with Mr. Utley; check of site; arrange for transmittal of patent
08/27/99 C WHEELER	1.00 Conf with Mr. Utley and Mr. Bernstein re funding and re technology test; schedule meeting
08/31/99 C WHEELER	.25 Conf with Mara Lerner re copyright follow up



Lorraine Christine Hoffman, Esq.
Assistant Staff Counsel
The Florida Bar
File No. 2003-51, 109(15C)

08/05/99 M ROBBINS	1.50 Telephone conferences to Healy re: assignment agreements. Inter-office conferences with Zammas re: stock issuances. Inter-office conference with Wheeler re: Utley employment agreement. Preparation of assignment agreement. Revisions to list of confidentiality agreements. Calculation of Utley shares. Inter-office conference with Thompson re: assignment agreements. Inter-office conference with Wheeler re: assignment agreements.
08/06/99 C WHEELER	1.00 Call to Mr. Brandon; conf with Mr. Bernstein and Mr. Utley
08/11/99 C WHEELER	2.00 Conf with Mr. Bernstein; conf with Mr. Utley; call to Mr. Epstein; brief conf with Mr. Epstein; conf with Mara Lerner re subscription agreements; call to Mr. Henninger re meeting and business plan;
08/10/99 C WHEELER	.50 Review of status of patent material; review of status of employment agreement
08/11/99 M ROBBINS	3.00 Research Delaware corporate statutes re: merger and voting rights. Review received note subscription agreements. Preparation of promissory notes for execution and mailing. Inter-office conferences with Zammas re: preparation of notes and documentary stamps. Preparation of correspondence to E. Bernstein. Inter-office conferences with Zammas re: issuance of promissory notes. Review files re: business plan legend. Revisions to correspondence to E. Bernstein. Inter-office conference with Thompson re: merger and voting rights. Inter-office conferences with Wheeler re: business plan review and intellectual property matters.
08/11/99 C WHEELER	.25 Conf with Mr. Utley re business plan and Real 3D
08/12/99 C WHEELER	.25 Organization of file matters
08/13/99 C WHEELER	.50 Review of status as to Agreement with Real 3D
08/26/99 C WHEELER	.50 Organize patents; conf with Mr. Utley; call on confidentiality agreement
08/27/99 C WHEELER	.50 Conf with Mr. Utley; check of site; arrange for transmittal of patent
08/27/99 C WHEELER	1.00 Conf with Mr. Utley and Mr. Bernstein re funding and re technology test; schedule meeting
08/31/99 C WHEELER	.25 Conf with Mara Lerner re copyright follow up



Lorraine Christine Hoffman, Esq.
Assistant Staff Counsel
The Florida Bar
File No. 2003-51, 109(15C)

09/10/99 C WHEELER 2.00 Conf with Mr. Brandon; conf with Mr. Brandon;
conf with Mr. Rubenstein; transmittal of
materials to Mr. Rubenstein; Call to Mr. Joao

—————→

This has Mr. Rubenstein on critical calls to Huizenga and being transferred materials, most likely from the Huizenga review by Steven Filipek, Esq.



Lorraine Christine Hoffman, Esq.
Assistant Staff Counsel
The Florida Bar
File No. 2003-51, 109(15C)

Karibjanian re: insurance provisions of Utley Employment Agreement. Revisions to Utley Employment Agreement. Inter-office conferences with Zammas re: Osterling Acknowledgment Agreement. Study and review memo from K. Healy re: iviewit intellectual property documents. Review patent applications and correspondence from patent counsel. Inter-office conferences with Zammas re: preparation of binders for patent documents. Draft and preparation of form of executive employment agreement. Preparation of correspondence to Utley re: Employment Agreement.

09/16/99 G KARIBJANIAN .50 Revise provision; discussions w/Mara Lerner-Robinson.

09/17/99 C WHEELER 1.00 Meeting with Mr. Utley re various matters; call to Mr. Brandon

09/21/99 C WHEELER .25 Call to Mr. Utley re patent meeting

09/21/99 C WHEELER 1.00 Conf with Mr. Utley re patent meeting and status of negotiations; call to Mr. Brandon

09/21/99 J ZAMMAS 4.75 Review subscription letter agreements and send to Brian Utley for signature; issue stock to Patricia Daniels and send to Eliot Bernstein for signature; preparation of patent document binders for C. Wheeler; send copies of Subscription Letter Agreements and LLC Agreements of iviewit LLC to Jude Rosario and Zakirul Shirajee; work on trademark binder.

09/22/99 C WHEELER 1.50 Meeting with Mr. Utley and Si Bernstein; call to Mr. Brandon; review of copyright material

09/22/99 J ZAMMAS 3.00 Work on patent binders and trademark binders for C. Wheeler; telephone Raymond Joao regarding all patents; compile all documents by shareholder/noteholder

09/23/99 J ZAMMAS .25 Telephone Raymond Joao regarding patents.

09/24/99 J ZAMMAS .50 Update shareholder list; telephone Raymond Joao's secretary regarding patents; advise C. Wheeler.

09/24/99 C WHEELER 1.00 Call on utilities; follow up on space requirements; conf on patent questions

09/27/99 C WHEELER .50 Follow up on conflict issue



Lorraine Christine Hoffman, Esq.
Assistant Staff Counsel
The Florida Bar
File No. 2003-51, 109(15C)

09/27/99 J ZAMMAS 2.50 Revise consents to indicate that Brian Utley is elected as Chief Operating Officer of the three entities; telephone calls from Mr. Joao's office regarding patents; complete work on patent binders for C. Wheeler; send stock certificate of uview.com, Inc. to Patricia Daniels; send iviewit.com LLC subscription letters to James Armstrong, Andrew Dietz, Lisa Friedstein and James Osterling.

09/28/99 C WHEELER 1.00 Conf with Chris Brandon; Call from Karen Chastain; follow up on consent

09/28/99 J ZAMMAS 1.00 Send subscription documents to Jude Rosario again; add patent to patent binders.

09/30/99 C WHEELER 3.00 Conference w/Brian Utley; conference with Mr. Bernstein; review of status re confidentiality agreement; conference as to transfer of patent information, business plans

11/29/99 J ZAMMAS .25 Copy official filing receipts for two patents, insert in patent binders and give two copies to Brian Utley to insert in his binders.

10/01/99 S KAPP .25 P/u with GB regarding immigration materials and other documents

10/01/99 C WHEELER 1.00 Conf with Mr. Brandon

10/02/99 C WHEELER 2.00 Conf with Mr. Utley; review of mail from Mr. Bernstein; review of status of

10/04/99 R STORETTE .25 Review immigration documents.

10/04/99 C WHEELER 3.00 Follow up on lease; conf with Mr. Brandon; conf with Mr. Utley; conf with Mr. Utley

10/06/99 C WHEELER 2.00 Call from Mr. Brandon; conf with Mr. Utley; attend meeting of board representatives

10/06/99 C WHEELER 1.50 Conf with Mr. Utley and Mr. Brandon

10/12/99 C WHEELER .50 Conf as to meeting;

10/19/99 C WHEELER .25 Call to Leo Abbe

10/20/99 C WHEELER 1.00 Conf with Mr. Brandon; conf with Mr. Utley

10/20/99 C WHEELER 2.00 Message from Mr. Brandon; conf with Mr. Utley; conf with Grunthal; arrange for revisions of Grunthal and Huizenga agreements

10/22/99 C WHEELER 1.00 Conf with Mr. Utley; conf with Mr. Lewin; transmittal of materials



Lorraine Christine Hoffman, Esq.
Assistant Staff Counsel
The Florida Bar
File No. 2003-51, 109(15C)

10/25/99 C WHEELER 2.00 Meeting with Mr. Utley, Messrs. Bernstein, Mr. Lewin; conf with Mr. Lewin; call to Mr. Brandon; arrange transmittal of confidentiality agreement; arrange transmittal to Brandon

10/25/99 M ROBBINS 2.50 Inter-office conferences with Chris Wheeler re: MachineWeb.com Confidentiality Agreement and License Evaluation Agreement. Preparation of Confidentiality Agreement. Preparation of License Evaluation Agreement. Multiple telephone conferences with Stuart Carlin. Preparation of correspondence to Carlin. Organization of iviewit corporate documents and files. Inter-office conference with G. Karibjanian re: transfer of shares to trusts. Telephone conference with S. Bernstein.

10/26/99 C WHEELER 1.00 Conf with Mr. Branden; conf with Mr. Utley

10/27/99 C WHEELER 1.00 Follow up on Grunthal matter

10/28/99 C WHEELER .50 Follow up on Grunthal

10/28/99 M ROBBINS 2.50 Inter-office conferences with Chris Wheeler re: Gruntal agreement. Meeting with Brian Utley re: Jenex amendment. Preparation of correspondence to Irwin Newman. Multiple telephone conferences with Leo Abbe and Mildred Colon re: modifications to Gruntal agreement. Review revised Gruntal agreement. Calculation and update revised iviewit LLC table of grants of membership units. Telephone conference with B. Utley re: Gruntal agreement.

10/29/99 S KAPP .25 F/u regarding immigration matter

10/29/99 M ROBBINS 3.25 Multiple telephone conferences with Mildred Colon of Gruntal re: revisions to Gruntal agreement. Review revised Gruntal agreement. Further revisions to Gruntal agreement. Meeting with S. Bernstein and B. Utley re: capitalization of uview and iviewit LLC. Meeting with Martha re: iviewit LLC Limited Liability Company Agreement. Inter-office conferences with J. Zammas re: Iantoni subscription agreements. Preparation of correspondence to Mildred Colon. Preparation of correspondence to Leo Abbe. Telephone conferences with Leo Abbe. Telephone conferences with E. Lewin re: written consents. Telephone conferences with Jerry Lewin re: capitalization matters. Inter-office conference with J. Zammas re: issuance of shares to Utley and execution of subscription agreement. Review uview certificate of incorporation re: par value. Review file re: New Media Holdings payment for units for Jerry Lewin.



Lorraine Christine Hoffman, Esq.
Assistant Staff Counsel
The Florida Bar
File No. 2003-51, 109(15C)

11/02/99 S KAPP .25 T/c with Zack regarding immigration matter and
E/u message to CCW

11/10/99 R STORETTE .50 General review various immigration cases;
various tel cons. with client; review immigrant
documentation.

11/19/99 D THOMPSON II 3.75 Prepare Letter of Intent with Webcasts;
Conference with Attorney Mara Lerner Robbins re
stock issues and letter of intent; meetings
with Brian Utley re same.

11/23/99 C WHEELER 1.00 Conf with Mr. Utley; review of agreement with
Webcast

11/29/99 M ROBBINS 5.25 Telephone conferences with Martha. Telephone
conferences with Jeff Stark re: issuance of
shares in exchange for furniture. Meeting with
J. Armstrong and S. Bernstein re: generic
website and license agreement and various
corporate matters. Preparation of generic
website and license agreement. Revise
Convertible Promissory Note. Inter-office
conferences with G. Coleman re: securities
issues relative to issuance of additional
shares and convertible note.

----- --
11/30/99 M ROBBINS 3.50 Preparation of modifications to convertible
note, security agreement, purchase agreement
and subscription agreement. Preparation of
modifications to generic website development
and license agreement. Inter-office
conferences with Gayle Coleman re: issuance of
note, security agreement and purchase agreement
for furniture. Inter-office conferences with
Gayle Coleman re: website development and
license agreement.

11/30/99 G COLEMAN 1.75 Preparation of revisions to furniture purchase
transaction documents including purchase
agreement, security agreement, and promissory
note. Inter-office conference with M. Robbins
re: same. Preparation of revisions to Generic
Web Site Agreement.

12/01/99 G COLEMAN .25 Inter-office conference with M. Robbins re:
licensing issues.

12/02/99 M ROBBINS 1.00 Meeting with B. Utley re: generic web site and
licensc agreement. Inter-office conference
with Thompson re: iviewit pending matter list.
Preparation of iviewit pending matter list.



Lorraine Christine Hoffman, Esq.
Assistant Staff Counsel
The Florida Bar
File No. 2003-51, 109(15C)

12/03/99 M ROBBINS 2.25 Meeting with Rocky Thompson re: pending matters and assignments. Preparation of additional revisions to generic website and license agreement. Inter-office conferences with Zammas re: same. Telephone conference with NY library re: background search. Preparation of e-mail re: Doc McGhee. Review Jenex Agreement termination provision. Review Gruntal Agreement. Inter-office conferences with Rocky

12/06/99 M ROBBINS 6.50 Review pending matters list. Telephone conferences with E. Lewin. Modifications to Joan Stark subscription agreement. Preparation of correspondence to Utley and Bernstein re: modified subscription agreement. Inter-office conferences with A. Levy re: blue sky exemption. Review file re: MacKenzie consulting agreement. Revisions to generic website agreement. Meeting with Rocky Thompson and Gayle Coleman re: pending matters. Telephone conferences with E. Lewin. Inter-office conferences with Coleman re: inter-company license agreement. Review sample license agreements. Telephone calls to S. Bernstein.

12/06/99 K HEALY .25 To w/R. Thompson re iVIEWIT work-for-hire agreements; locate copyright language for draft agreements

12/09/99 K HEALY .25 To w/R. Johnson re Confidentiality and Proprietary Rights Agmt.

12/03/99 M ROBBINS 2.25 Meeting with Rocky Thompson re: pending matters and assignments. Preparation of additional revisions to generic website and license agreement. Inter-office conferences with Zammas re: same. Telephone conference with NY library re: background search. Preparation of e-mail re: Doc McGhee. Review Jenex Agreement termination provision. Review Gruntal Agreement. Inter-office conferences with Rocky

12/06/99 D THOMPSON II .75 Telephone conference with Ron Storette re immigration issues; Follow-up re same.

12/06/99 C WHEELER 2.00 Conf with Mr. Utley re status of various matters; follow up on immigration problems; conf as to capital; conf with Mr. Storette



Lorraine Christine Hoffman, Esq.
Assistant Staff Counsel
The Florida Bar
File No. 2003-51, 109(15C)

12/06/99 M ROBBINS 6.50 Review pending matters list. Telephone conferences with E. Lewin. Modifications to Joan Stark subscription agreement. Preparation of correspondence to Utley and Bernstein re: modified subscription agreement. Inter-office conferences with A. Levy re: blue sky exemption. Review file re: MacKenzie consulting agreement. Revisions to generic website agreement. Meeting with Rocky Thompson and Gayle Coleman re: pending matters. Telephone conferences with E. Lewin. Inter-office conferences with Coleman re: inter-company license agreement. Review sample license agreements. Telephone calls to S. Bernstein.

12/07/99 D THOMPSON II 2.50 Finalize Confidentiality and Proprietary Rights Agreement; review pending projects.

12/07/99 C WHEELER 1.00 Conf with Mr. Utley; follow up on immigration matters; check on transfer of Bernstein interests

12/08/99 D THOMPSON II .75 Prepare Work-for-Hire Agreement; Conference with Ray Joa re same.

12/08/99 D THOMPSON II .75 Conference with Attorney C. Wheeler re pending matters; Follow-up re same.

12/08/99 G COLEMAN 2.00 Preparation of inter-company license agreement and form for sublicenses.

12/09/99 D THOMPSON II .50 Analysis of License Agreement issues.

12/09/99 M ROBBINS 3.75 Review draft of Inter-Company License Agreement. Preparation of comments to Inter-Company License Agreement. Inter-office conferences with Coleman and Thompson re: status of assignments and license agreements. Preparation of replacement documents for S. Bernstein. Telephone call to Utley re: Joan Stark agreements. Telephone conference with J. Armstrong re: organization of iviewit entities. Inter-office conference with J. Zammass re: preparation of documents to J. Armstrong re: organization of iviewit entities. Preparation of e-mail to J. Armstrong. Telephone conferences with J. Armstrong. Meeting with Gayle Coleman re: securities matters.

12/09/99 G COLEMAN .75 Preparation of inter-company license.

12/09/99 J ZAMMAS 1.00 Insert documents into patent binders; give documents to Brian Utley to insert in their binders; fax charts to James Armstrong.

12/09/99 D THOMPSON II .50 Analysis of License Agreement issues.



Lorraine Christine Hoffman, Esq.
Assistant Staff Counsel
The Florida Bar
File No. 2003-51, 109(15C)

- 12/10/99 R STORETTE .50 Review Confidentiality Agreement from immigration perspective; various tel conversations DT.
- 12/10/99 D THOMPSON II 1.75 Prepare License Agreements; Coordinate same with Attorneys Mara Lerner Robbins and Gayle Coleman re same.
- 12/10/99 M ROBBINS 5.50 Inter-office conferences with Gayle Coleman re: preparation of offering memorandum. Preparation of offering memorandum. Gather information for use on preparing offering memorandum. Meeting with Gayle Coleman and Rocky Thompson re: modifications to generic website agreement and modifications to inter-company license agreement. Inter-office conferences with Jill Zamas re: D & O Questionnaires. Review D & O Questionnaires and modify same. Review and revise correspondence to Utley, E. Bernstein and S. Bernstein re: D&O Questionnaires. Telephone conferences with J. Armstrong. Modifications to generic website agreement per Armstrong's comments. Revisions to inter-company license agreement. Review correspondence re: summary of current technology. Inter-office conference with C. Wheeler re: Dan Sokiloff background search. Telephone conference with New York library re: Dan Sokiloff background search.
- 12/10/99 G COLEMAN 4.00 Inter-office conference with D. Thompson and M. Robbins re: inter-company license. Preparation of revisions to inter-company license. Preparation of form private offering memorandum.
- 12/13/99 D THOMPSON II 1.75 Meeting with Attorneys Mara Lerner Robbins and Gayle Coleman re securities issues; licensing issues and pending projects; coordinate same.



Lorraine Christine Hoffman, Esq.
Assistant Staff Counsel
The Florida Bar
File No. 2003-51, 109(15C)

12/13/99 M ROBBINS 6.75 Meeting with Simon Bernstein re: furniture purchase, projects and assignments. Meeting with Rocky Thompson and Gayle Coleman re: assignments and projects. Preparation of private offering memorandum. Organization of corporate files. Preparation of Essex term sheet. Multiple telephone conferences with Utley, Martha, E. Lewin, J. Lewin. Preparation of replacement furniture documents for S. Bernstein. Inter-office conferences with J. Zamas. Telephone conferences with NY library re: Sokiloff background search. Preparation of modifications to Inter-Company License Agreement and Web Site and License Agreement. Multiple inter-office conferences with Gayle Coleman re: Web Site and License Agreement and general securities matters. Telephone conference with J. Lewin re: assignment of notes from iviewit.com to uview. Review subscription agreement terms for issuance of notes. Review iviewit LLC Limited Liability Company Agreement.

12/13/99 G COLEMAN 6.50 Preparation of Term Sheet for Essex/Crate offering. Preparation of form Private Offering Memorandum. Inter-office conference with D. Thompson and M. Lerner Robbins re: pending transactions and issues. Study and revise sublicense agreement. Multiple inter-office conferences with M. Robbins re: intercompany license and sublicense agreements. Study, review and revise intercompany license and sublicense agreement.

12/14/99 D THOMPSON II .25 Review License Agreement.

12/15/99 D THOMPSON II 1.50 Review and revise license agreements; Meeting with Attorney Mara Lerner Robbins re same and investment banking matters.



Lorraine Christine Hoffman, Esq.
Assistant Staff Counsel
The Florida Bar
File No. 2003-51, 109(15C)

- 12/17/99 M ROBBINS 7.50 Review and preparation of comments to Independent Contractor Agreement for photographers and videographers. Review draft offering memorandum. Telephone conferences with E. Lewin. Meeting with E. Lewin re: D&O insurance application and election of B. Utley and J. Lewin to boards. Preparation of iviewit LLC corporate documents for E. Lewin. Draft and preparation of written consent electing B. Utley and J. Lewin to boards of uview.com, Inc., iviewit LLC and iviewit.com LLC. Review iviewit LLC and iviewit.com LLC limited liability company agreements. Review outstanding securities of iviewit LLC and uview.com LLC. Inter-office conferences with Jill Zamas re: organizational matters. Review organizational documents. Review Delaware statutes re: restructuring matters. Inter-office conference with Rocky Thompson re: potential restructuring. Preparation of correspondence to Armstrong and Utley. Multiple inter-office conferences with Gayle Coleman re: Independent Contractor Agreement, offering document, business section of offering document, intellectual property matters.
- 12/20/99 M ROBBINS 6.00 Inter-office conferences with Gayle Coleman re: Independent Contractor Agreement. Review and revise same. Draft and preparation of correspondence to Utley and Armstrong re: Inter-Company License Agreement and Web Site License Agreement. Draft and preparation of correspondence to Guy Iantoni re: Independent Contractor Agreement. Meeting with Rocky Thompson and Gayle Coleman re: restructuring and preparation of restructuring documentation. Inter-office conferences with Jill Zamas re: formation of new entities in connection with restructuring. Telephone conference with S. Bernstein re: termination of Jenex agreement. Revisions to Jenex termination letter. Inter-office conferences with Jill Zamas re: execution of Jenex Agreement. Multiple meetings with Gayle Coleman and Rocky Thompson re: restructuring matters. Review certificate of incorporation of iviewit.com, Inc. and iviewit Holdings, Inc. Review and revise Restructuring Checklist. Review and revise agreement between iviewit.com, Inc. and iviewit LLC. Inter-office conferences with Gayle Coleman re: Restructuring Checklist. Telephone conference with S. Bernstein re: solicitation of additional investments.



Lorraine Christine Hoffman, Esq.
Assistant Staff Counsel
The Florida Bar
File No. 2003-51, 109(15C)

- 12/20/99 G COLEMAN 6.75 Preparation of form of private offering memorandum. Inter-office conferences with M. Robbins re: Independent Contractor/Videographer agreement. Review and revise same. Telephone conference with Utley. Telephone conference with G. Iantoni. Multiple inter-office conferences with D. Thompson and M. Robbins re: restructuring and preparation of restructuring documents. Inter-office conference with J. Zamas re: formation of new corporations, preparation of bylaws and organizational resolutions. Telephone conferences with S. Romoff re: tax issues. Preparation and revisions of restructuring checklist. Preparation of agreement between iviewit.com, Inc. and iviewit.com LLC. Preparation of consents. Inter-office conferences with M. Robbins. Telephone conferences with G. Reed. Telephone conferences with R. Joao.
- 12/21/99 G COLEMAN 7.50 Multiple inter-office conferences with M. Robbins re: iviewit.com LLC/iviewit.com, Inc. transaction and iviewit LLC/iviewit Holdings, Inc. transaction. Telephone conference with K. Farrell re: trademarks. Telephone conferences with B. Schiff re: trademark assignments. Telephone conferences with R. Joao's office re: preparation of assignment of patents. Preparation of asset purchase agreement, bills of sale and assignment and assumption agreements. Preparation of consents. Inter-office conferences with J. Zamas. Review Delaware requirements for dissolutions. Study and review llc agreements for iviewit LLC. Preparation of exhibits. Telephone conference with S. Romoff re: lease assignment issues and S corporation. Review terms of lease and sublease. Inter-office conferences re: lease and credit line issues. Multiple telephone conferences with M. Robbins and S. Romoff re: same. Preparation of e-mail correspondence re: llc issues.
- 12/22/99 M ROBBINS 7.00 Telephone conference with S. Bernstein and G. Iantoni re: web site agreement. Revise restructuring checklist. Inter-offices with Zamas re: closing documents and preparation of closing files. Preparation of e-mails to Spencer Romoff re: restructuring matters. Multiple telephone conferences with Spencer Romoff re: restructuring matters. Review and
- 12/28/99 G COLEMAN 8.25 Inter-office conference with C. Wheeler re: term sheet and private offering memorandum. Multiple inter-office conferences with M. Robbins. Study and revise convertible



Lorraine Christine Hoffman, Esq.
Assistant Staff Counsel
The Florida Bar
File No. 2003-51, 109(15C)

01/10/00 G COLEMAN 6.75 Inter-office conference with M. Robbins re: term sheet for Essex. Multiple inter-office conferences with C. Wheeler re: name changes and intellectual property issues. Multiple inter-office conferences with M. Robbins re: name changes and corporate documentation. Inter-office conference with D. Thompson re: term sheets and Essex Capital. Conference with B. Utley re: terms of private offering memorandum. Conference with G. Lewin re: due diligence and net losses. Multiple inter-office conferences with J. Zammas re: due diligence. Preparation of private offering memorandum and subscription documents. Calculation of stock ownership. Study and review Emerald Partners agreement for calculations. Revise stockholder calculations. Study and review amendments and support for name change. Calculation of shares.

01/10/00 J ZAMMAS 2.25 Discussion with M. Robbins regarding name changes for iviewit companies; contact paralegal in NY office regarding assignment of patents; work on name-change amendments; compile due diligence documents.

01/11/00 C WHEELER 1.00 Conf with Mr. Bernstein re patents and infringement

01/11/00 C WHEELER 1.00 Conf with Elliot Bernstein

01/11/00 C WHEELER 1.00 Conf with Mr. Utley

01/11/00 C WHEELER 1.00 Conf with Mr. Joao re patents

01/11/00 C WHEELER .50 Conf with Mr. Lewin re patents

01/11/00 G COLEMAN 7.50 Preparation of private offering memorandum revisions. Multiple inter-office conferences with M. Robbins and J. Zammas re: due diligence

information. Conference with E. Lewin re: due diligence. Study and revise revisions to



Lorraine Christine Hoffman, Esq.
Assistant Staff Counsel
The Florida Bar
File No. 2003-51, 109(15C)

private offering memorandum. Make name changes to offering memorandum. Telephone conferences with M. Robbins re: due diligence, warrants, forms of agreements and intellectual property issues. Preparation of detailed memorandum re: PPM. Inter-office conference with M. Robbins re: due diligence and private offering issues. Follow-up on Investech transaction, name change, et al. Preparation of due diligence.

01/12/00 G COLEMAN .75 Preparation of due diligence response.
01/12/00 J ZAMMAS 8.00 Fax Articles of Amendment for iviewit Holdings, Inc. and uview.com, Inc. to CorpAmerica for filing; work on due diligence documents;
01/13/00 C WHEELER .25 Conf with Ms. Robbins re due diligence
01/13/00 M ROBBINS 9.00 Preparation of due diligence materials for Alpine Venture Capital. Multiple meetings with Erika Lewin, Gayle Coleman and Jill Zammas re: same. Inter-office conference with Rocky Thompson re: new corporate structure, Alpine

term sheet.

01/13/00 G COLEMAN 8.25 Multiple telephone conferences with Martha re: missing information for \$500,000 private offering memorandum. Meeting with B. Utley re: private offering memorandum and Investech. Meeting with E. Bernstein re: private offering memorandum. Multiple office conferences with E. Lewin re: restructure, private offering memorandum, and financial information. Multiple office conferences with M. Robbins re: due diligence. Study and Revise private offering memorandum. Preparation of duplicate offering memorandum re: Investech. Prepare summary of restructure. Telephone conference with G. Lewin re: share ownership. Preparation of memo to B. Utley. Preparation of analysis of corporate structure. Review and revise letter to Bell re: due diligence. Assist in due diligence response.
01/13/00 J ZAMMAS 4.25 Work on compiling due diligence documents; fax name-change amendment of iviewit Holdings, Inc. to the Florida Secretary of State; update stockholder/member lists.
01/14/00 D THOMPSON II .75 Conference and analysis with Attorneys C. Wheeler and G. Coleman re securities and technology issues.
01/14/00 C WHEELER 1.00 Conf with Mr. Utley and Mr. Rubenstein



Lorraine Christine Hoffman, Esq.
Assistant Staff Counsel
The Florida Bar
File No. 2003-51, 109(15C)

01/14/00 M ROBBINS 6.25 Telephone conference with Rodney Bell re: due diligence materials. Meetings with E. Lewin re: additional due diligence items. Telephone conferences with Maurice Buchsbaum and Eliot Bernstein re: business plan. Inter-office conference with Gayle Coleman re: private offering memorandum, revisions to offering memorandum re: risk factors for potential infringement and business plan. Review annotated due diligence list and conferences

with Jill Zammas re: same. Revisions to stockholder lists of iviewit entities. Preparation of memorandum to corporate department re: iviewit structure and organizational charts. Meeting with Erika Lewin re: business plan and audited financials. Preparation of e-mail to Gayle Coleman re: business plan and financials. Draft and preparation of correspondence to Rodney Bell. Preparation of e-mail to Jill Zammas re: due diligence request list documents. Inter-office conferences with Rocky Thompson re: dissolution of iviewit LLC, acknowledgment agreement to employment agreement for stock splits, Investech share exchange, minority shareholder exchange option.

01/14/00 G COLEMAN 3.25 Telephone conference with Martha re: private offering memorandum. Telephone conference with E. Lewin re: audited financial statements. Inter-office conference with R. Thompson re: private offering memorandum and information to be included. Preparation of revisions to intellectual property risk factors. Inter-office conference with C. Wheeler re: potential intellectual property infringement. Multiple inter-office conferences with M. Robbins re: due diligence, private placement and infringement issues. Preparation of chart for corporate restructure. Multiple inter-office conferences re: business plan.

01/14/00 J ZAMMAS 5.25 Work on due diligence lists of documents; fax documents to Rod Bell.



Lorraine Christine Hoffman, Esq.
Assistant Staff Counsel
The Florida Bar
File No. 2003-51, 109(15C)

01/17/00 G COLEMAN 7.75 Inter-office conference with R. Thompson re: financial disclosure issues. Inter-office conference with R. Thompson re: risk factors related to intellectual property. Multiple-inter-office conferences with M. Robbins re: corporate structure and business plan modifications. Conference with E. Lewin re: financial information. Telephone conference with K. Rubinstein re: possible infringement. Review and comment on proposed form of Business Plan. Study and revise form of warrant certificate for Emerald Partners.



01/18/00 G COLEMAN 5.00 Preparation of revisions to form of Warrant for Emerald Partners. Inter-office conference with A. Levy re: same. Preparation of revisions to risk factors relating to intellectual property and to private offering memorandum. Preparation of revisions to business plan.

01/19/00 D THOMPSON II .75 Follow-up on Alpine matter.

02/02/00 M ROBBINS 6.25 Multiple inter-office conferences with Rocky Thompson re: corporate structure and potential merger, Alpine term sheet, calculation of shares, confidentiality agreement. Preparation of correspondence to Villasana. Multiple telephone conferences with Villasana re: due diligence and patent assignments. Multiple inter-office conferences with Jill Zammis re: registration of name change, written consent admitting Buchsbaum to board. Review written consent re: directors. Review Articles of Incorporation and Delaware statutes re: merger, increase size of Board. Telephone conferences with Gayle Coleman re: patent assignments and

From blank page

Alpine transaction. Telephone conferences with



Lorraine Christine Hoffman, Esq.
Assistant Staff Counsel
The Florida Bar
File No. 2003-51, 109(15C)

- 02/02/00 J ZAMMAS 4.00 Order new stock certificates for iviewit Technologies, Inc.; discuss certificates with Blackstone Legal Supply; work on closing binders; telephone Ray Joao and Frank Martinez to obtain copy of filed assignment of patents; discuss election of Maurice Buchsbaum as a director of iviewit Holdings, Inc. with M. Robbins; preparation of written consent electing Maurice Buchsbaum a director of iviewit Holdings, Inc.; preparation of name-change amendment of uview.com, Inc. to be filed in Florida; have amendment signed by Brian Utley; telephone George Villasana regarding patent assignments; fax copy of Confidentiality Agreement to George Villasana.
- 02/03/00 J ZAMMAS 3.50 Discuss assignment of patents received with M. Robbins; fax assignments to George Villasana; give copy to Erika Lewin for their records; place copy in binders; have name-change amendment for uview.com, Inc. filed with the Florida Secretary of State; fax name-change amendments to Ray Joao; deliver closing binders to attorneys and Brian Utley; revise UCC-1 for A. Levy.
- 02/04/00 M ROBBINS 3.25 Telephone conferences with Spencer Romoff re: B Reorganization. Telephone conference with E. Lewin re: patent applications forwarded to Villasana and due diligence. Inter-office conference with Rocky Thompson re: B Reorganization and status of Webcast letter of intent. Telephone conference with Brian Utley re: status of Webcast letter of intent. Preparation of e-mail to E. Lewin. Review redlined Term Sheet re: Alpine investment. Preparation of e-mails to George Villasana. Telephone conference with Rocky Thompson and Spencer Romoff re: share exchange. Review and revise Assignment of License Agreement. Review file re: reorganization documents. Inter-office conferences with Jill Zammass re: additions to due diligence binders. Telephone conferences with Spencer Romoff re: reorganization.



Lorraine Christine Hoffman, Esq.
Assistant Staff Counsel
The Florida Bar
File No. 2003-51, 109(15C)

- 02/07/00 M ROBBINS 9.00 Telephone conferences with Guy Iantoni re: inter-company license agreement and assignment thereof. Revisions to Assignment of License Agreement between iviewit LLC and iviewit Technologies. Revisions of License Agreement between iviewit.com LLC and iviewit.com, Inc. Preparation of memorandum to Brian Utley re: License Agreements. Telephone conferences with Brian Utley re: status of Webcast Agreement. Telephone conference with George Villasana re: Webcast. Inter-office conferences with Rocky Thompson re: transaction documentation. Multiple telephone conferences with George Villasana re: Alpine transaction. Telephone conferences with Brian Utley re: additional note subscription agreements. Review and preparation of comments to Alpine Shareholders Agreement, Purchase Agreement, Investors Rights Agreement, Certificate of Designations and Management Rights Agreement.
- 02/09/00 M ROBBINS 8.25 Multiple telephone conferences with George Villasana. Telephone conferences with E. Lewin re: preparation of schedules to purchase agreement. Inter-office conferences with Rocky Thompson and Jill Zammis re: appointment of Buchsbaum to Board. Review Delaware law re: filling of vacancies on Board. Draft and preparation of subscription agreements for new notes. Preparation of correspondence to Ray Joao re: comments to Securities Purchase Agreement. Telephone conference with Ray Joao re: comments to Securities Purchase Agreement. Telephone conference with E. Lewin re: notes.
- 02/11/00 J ZAMMAS 1.50 Get copy of Exhibit A to Erika; fax name-change amendment of iviewit.com, Inc. to Rob Zeigen; preparation of Confidentiality and Propriety Rights Agreements for Jude Rosario and Zakirul Shirajee; bring to iviewit to have executed; follow-up regarding return of furniture documents; follow-up with iviewit re return of furniture documents; telephone Joan Stark regarding return of documents.



Lorraine Christine Hoffman, Esq.
Assistant Staff Counsel
The Florida Bar
File No. 2003-51, 109(15C)

02/15/00 M ROBBINS 8.75 Telephone conference call with Rodney Bell and Rocky Thompson re: comments to Alpine transaction documents. Inter-office conferences with Rocky Thompson re: Alpine transaction documents and preparation of documents for closing. Inter-office conferences with Jill Zamas re: preparation of schedule to purchase agreement, written consent and closing checklist. Draft and preparation of opinion to Alpine investors. Inter-office conference with Jill Zamas re: proprietary rights agreement. Inter-office conferences with Gayle Coleman re: nondisclosure, noncompete and proprietary rights agreement. Revisions to closing checklist. Preparation of Secretary's Certificate. Preparation of President and Secretary's Certificate re: reps and warranties. Preparation of President and Secretary's Certificate re: performance. Review

from blank page with no page number

and revise schedules to securities purchase

agreement. Multiple telephone conferences with Brian Utley. Review revisions to Alpine transaction documents.

02/15/00 G COLEMAN 5.00 Preparation of subscription document for exchange offering of notes. Preparation of subscription documents for convertible note offering. Preparation of revisions to Convertible Note. Preparation of correspondence. Inter-office conference with J. Zamas re: closing checklist for Alpine transaction. Preparation of Non-Compete, Non-Disclosure and Inventions Agreement for Alpine transaction. Inter-office conference with M. Robbins re: Alpine transaction and supporting documents. Preparation of Non-Disclosure and Inventions Agreement for Alpine transaction. Inter-office conference re: closing checklist and modifications thereto.

02/16/00 D THOMPSON II 2.00 Follow-up matters on Alpine investment.

02/21/00 D THOMPSON II 3.50 Prepare Convertible Note documents and forms of confidentiality, non-compete and inventions agreements.

02/23/00 R ROWE .25 Rev. opinion to investors; Tel. RT re opinion

02/23/00 D THOMPSON II 5.75 Prepare opinion; Follow-up on open issues; Telephone conferences with distribution group; Prepare for closing.



Lorraine Christine Hoffman, Esq.
Assistant Staff Counsel
The Florida Bar
File No. 2003-51, 109(15C)

02/23/00 G COLEMAN 6.25 Multiple conferences with Martha. Multiple interoffice conferences with J. Zammas. Multiple inter-office conferences with R. Thompson. Preparation of form of opinion. Telephone conference with S. Wiener re: blue sky issues. Preparation of Blue Sky memo re: conversation with S. Wiener. Review and revise form of opinion. Inter-office conferences with R. Thompson re: opinion. Telephone conferences with B. Utley re: indemnification agreement. Study and compare Utley employment agreement with new non-compete/non-disclosure agreement. Preparation of revised non-compete/non-disclosure for B. Utley. Preparation of subscription document for J. Armstrong (no note documentation).

02/24/00 R ROWE .50 Rev. opinion to investors; Tel. RT(2x) re opinion

02/24/00 D THOMPSON II .50 Conference with Attorney C. Wheeler re opinion and Gruntal matters.

02/24/00 C WHEELER .50 Conference as to opinion; Conference w/B.Utley

02/24/00 C WHEELER 1.00 Review of iviewit opinion; conference w/R.Thompson re same

02/28/00 M ROBBINS 5.25 Numerous post-closing matters for Alpine transaction. Meetings with Rocky Thompson re: share exchange option agreement, board consents, preferred stock designations. Meeting with Jill Zammas re: post-closing matters and follow up. Conferences with Jill Zammas re: schedules to Alpine purchase agreement. Telephone conferences with Villasana re: license agreements. Review minute books. Telephone conferences with Iantoni re: web site development agreement entity change. Review web site agreement. Telephone conferences with Matacon. Inter-office conferences with Thompson re: Emerald warrants. Review correspondence

from blank page with no page number

from Buchsbaum re: warrants. Review memoranda



Lorraine Christine Hoffman, Esq.
Assistant Staff Counsel
The Florida Bar
File No. 2003-51, 109(15C)

02/29/00 M ROBBINS 5.50 Review closing binder for Investech and correspondence thereto. Inter-office conferences with Jill Zammass re: Investech binder, minutes, Certificate of Correction. Telephone conferences with Martha Matecon re: Web Site License Agreement. Inter-office conference with Gayle Coleman re: Web Site License Agreement. Inter-office conferences with A. Levy re: ECPI warrants. Inter-office conferences with Gayle Coleman re: Certificate of Designations for iviewit Technologies and corresponding issuances in subsidiary. Telephone call to Epstein. Review and revise Certificate of Designations. Review correspondence from Buchsbaum re: warrants. Telephone conferences with Buchsbaum re: warrant. Inter-office conference with Wheeler re: Armstrong employment agreement, Welsch issuance and Gruntal agreement. Review form of executive employment agreement. Place call to Alan Epstein re: exchange option agreement. Review exchange option agreement. Review ECPI engagement letter re: warrants issuable to

from blank page with no page numbers

Buchsbaum. Multiple telephone conferences with E. Lewin re: disclosures on loan application

and corporate structure. Multiple telephone conferences with George Villasana re: post-closing matters.

03/08/00 M ROBBINS 1.50 Meeting with Eliot Bernstein and Mitch Welsch. Inter-office conference with J. Zammass re: notice to stockholders of ability to exchange uvview certificates. Review form letter to stockholders. Inter-office conferences with J. Zammass re: post-closing clean-up matters. Review file re: Gruntal agreement.

03/10/00 M ROBBINS .75 Telephone conferences with E. Bernstein. Inter-office conference with C. Wheeler re: Armstrong Employment Agreement. Review Alpine closing file re: Armstrong noncompetition/inventions agreement

03/13/00 M ROBBINS 3.50 Draft and preparation of Armstrong Employment Agreement. Telephone conference with Randy Greenberg re: name changes. Inter-office conferences with J. Zammass re: execution of nondisclosure and inventions agreements.



Lorraine Christine Hoffman, Esq.
Assistant Staff Counsel
The Florida Bar
File No. 2003-51, 109(15C)

03/13/00 J ZAMMAS .50 Review Securities Purchase Agreement for M. Robbins; check to see if James Armstrong had signed a Non-Compete Agreement; discuss with M. Robbins.

03/14/00 M ROBBINS .50 Preparation of memo to Utley re: Armstrong employment agreement. Telephone conference with Mantecon re: execution of noncompetition/inventions agreement by Armstrong. Inter-office conferences with J.Zammas re: requirements to execute nondisclosure/inventions agreement under Alpine transaction.

03/16/00 M ROBBINS 3.75 Telephone conference with B. Utley re: comments to Armstrong employment agreement, Welsch project. Preparation of modifications to Armstrong employment agreement per Utley's comments and to incorporate non-compete, non-disclosure, inventions language from form of Alpine agreement. Telephone conference with E. Lewin re: capitalization structure. Telephone call to Welsch. Review Alpine agreement. Review form of Non-Compete; Non-Disclosure and Proprietary Rights Agreement. Telephone call to I. Levin re: Armstrong employment agreement.

03/30/00 C WHEELER .25 Conference w/B.Utley re copyright

03/30/00 K HEALY .25 Tc w/M. Lerner Robbins re iviewit copyright "fair use" issues

04/03/00 C WHEELER .25 Address audit questions

04/03/00 G COLEMAN .25 Respond to audit response letter.

04/03/00 J ZAMMAS 1.00 Work on audit letter for iviewit.com, Inc.; send inquiry memoranda to attorneys.

04/04/00 K HEALY .25 Response to Audit Letter

04/04/00 J ZAMMAS .50 Work on audit letter.

04/05/00 C WHEELER .25 Review of status of audit letter

04/07/00 D DE PARIS JR .25 Assist C. Wheeler re: audit response letter.

04/07/00 S KAPP .25 Respond to inquiry re: audit letter

04/07/00 C WHEELER .50 Follow up on iviewit audit letter

04/07/00 G COLEMAN .25 Audit response letter.



Lorraine Christine Hoffman, Esq.
Assistant Staff Counsel
The Florida Bar
File No. 2003-51, 109(15C)

04/11/00 M ROBBINS 1.50 Preparation of e-mail to Wippman re: Armstrong employment agreement. Inter-office conference with C. Wheeler re: pending assignments. Telephone call to Wippman. Review Wippman's comments to Armstrong employment agreement. Review Gruntal agreement. Preparation of e-mail to Rocky Thompson re: pending assignments.

04/12/00 M ROBBINS 5.25 Telephone conference with Tom Wippman re: comments to Armstrong employment agreement. Telephone conference with Mantecon. Review Wippman's comments to Armstrong employment agreement. Preparation of additional comments to Armstrong employment agreement. Review Gruntal agreement terms. Preparation for meeting with B. Utley. Preparation of e-mail to B. Schiff re: patent/trademark office amendment filings. Meeting with Brian Utley re: various assignments. Inter-office conference with J. Zammas re: stock issuance to J. Gregg, executed Board consents. Telephone conference with Mantecon re: Gregg subscription agreement. Draft and preparation of memo to K. Healy re: trademark protection for logo and tag line. Inter-office conference with C. Wheeler re: trademark, pending matters. Telephone conference with G. Coleman re: logo and tag line.

preparation of memo to B. Utley re: preemptive rights notice. Update pending matters list. Draft and preparation of Website Development Agreement. Review Gruntal Agreement. Review Investor Rights Agreement re: affiliated transaction. Additional modifications to pending matters list. Review revised stock ledger. Telephone call to B. Schiff.

04/14/00 M ROBBINS 1.25 Review revised ledger. Preparation of Web Site Development Agreement. Inter-office conference with J. Zammas re: documentary stamps on exchange notes. Review provisions of Gruntal Agreement and ECPI agreement.

04/17/00 M ROBBINS 2.00 Telephone conference with Mantecon. Telephone conference with B. Utley. Telephone conference with T. Wippman. Revisions to Armstrong Employment Agreement. Revisions to Web Site Development Agreement. Inter-office conference with J. Zammas re: doc stamps. Review correspondence to Villasana.

04/18/00 M ROBBINS .50 Draft and preparation of memo to B. Utley re: Ryjo, Inc. Web Site Development Agreement. Telephone conference with G. Iantoni.



Lorraine Christine Hoffman, Esq.
Assistant Staff Counsel
The Florida Bar
File No. 2003-51, 109(15C)

04/19/00 C WHEELER .50 Review of status of web agreement

04/21/00 C WHEELER .50 Review of materials and correspondence

04/24/00 C WHEELER .25 Arrange for review of confidentiality agreement

04/25/00 D THOMPSON II .25 Conference with Attorney Mara Lerner Robbins re confidentiality agreement.

04/25/00 C WHEELER .25 Arrange review of confidentiality agreement

04/25/00 M ROBBINS 2.75 Telephone conferences with B. Utley re: AEC confidentiality agreement. Review and comments on AEC confidentiality agreement. Telephone conference with G. Iantoni re: Sitesnet agreement. Meeting with G. Iantoni re: Sitesnet agreement. Review draft of Sitesnet agreement. Telephone conference with G. Reed re: Sitesnet agreement, copyright issues. Inter-office conference with Rocky Thompson. Preparation of stock option plan. Review Alpine documents re: limitations on adoption of stock option plan.

04/28/00 C WHEELER .25 Conf with Mr. Utley; arrange for review of confidentiality agreements

04/28/00 M ROBBINS .50 Telephone conference with B. Utley re: nondisclosure agreements; capitalization. Review correspondence from Utley re: stock split. E-mail to Thompson re: stock split and pending matters. Inter-office conference with A. Levy re: non-disclosure agreements.

05/01/00 A GORTZ .10 Ken Rubenstein call

05/01/00 A LEVY 2.00 Review and comment on No-Disclosure Agreements; meeting with B. Utley.

05/02/00 J ZAMMAS .75 Discuss promissory notes and documentary stamps with Martha at iviewit; discuss documents with M. Robbins; send copies of Non-Competition, Non-Disclosure and Proprietary Rights Agreements to George Villasana at Holland & Knight; preparation of list of exchange and new noteholders.

05/24/00 M ROBBINS .25 Telephone conference with J. Osterling. Telephone call to M. Mantecon.

06/02/00 G COLEMAN .25 Intellectual property matters.



Lorraine Christine Hoffman, Esq.
Assistant Staff Counsel
The Florida Bar
File No. 2003-51, 109(15C)

06/21/00 C WHEELER	.50 Conf with due diligence representatives at Wachovia
06/29/00 C WHEELER	1.00 Conf as to status of Iviewit; dictation of memo re same
07/10/00 C WHEELER	.25 Conf with Mr. Bernstein re patents as collateral
07/18/00 C WHEELER	1.00 Meeting on Iviewit matters; conf with Andrew Levy; conf with Mr. Utley
07/18/00 C WHEELER	1.00 Board meeting; conf with Mr. Elliot Bernstein
07/26/00 C WHEELER	.50 Conf with Mr. Armstrong; begin review of materials
07/27/00 C WHEELER	1.00 Conf with Mr. Utley re patents; conf with Mr. Bernstein re same
07/30/00 C WHEELER	1.00 Review of Warner's confidentiality agreement
07/31/00 C WHEELER	2.00 Meeting with Iviewit representatives re patent
08/09/00 J ZAMMAS	1.25 Review due diligence binders to locate License Evaluation Agreement; calculate Delaware Franchise Tax for M. Robbins.
08/18/00 C WHEELER	.25 Transmit materials to potential investor
08/25/00 C WHEELER	.25 Conf with Mr. Utley re draft of Wachovia letter
09/05/00 C WHEELER	.50 Conf with Mr. Utley; review of Wachovia letter
09/27/00 C WHEELER	1.50 Conf with Mr. Assaf; conf with Mr. Bernstein; Conf with Mr. Prolow; conf with Mr. Utley
09/28/00 C WHEELER	1.00 Call to Mr. Prolow; conf with Mr. Utley
09/28/00 C WHEELER	.50 Conf with Mr. Prolow
09/29/00 C WHEELER	2.50 Conf with Mr. Prolow and Mr. Utley; conf. with Prolow, Utley, Hersch, Buschbaum, et al re technology;
09/29/00 C WHEELER	.25 Call from Mr. Prolow
10/02/00 C WHEELER	.50 Follow up on conference call; call to Mr. Prolow



Lorraine Christine Hoffman, Esq.
 Assistant Staff Counsel
 The Florida Bar
 File No. 2003-51, 109(15C)

10/03/00 C WHEELER	1.00	Conf with Mr. Utley; conf with Mr. Utley; call to Mr. Prolow
10/03/00 C WHEELER	2.00	Conf call with Mr. Applestein, Mr. Prolow, Mr. Utley, Mr. Herish, et. al.; conf with Mr. Herish
10/03/00 C WHEELER	.50	Conf with auditors
10/04/00 C WHEELER	.25	Review of audit opinion
10/04/00 J ZAMMAS	.75	Preparation of audit update letter; e-mail to NY office for approval; have executed; telephone Martha at iviewit re fax number for Brian Fox; fax and mail letter to Brian Fox at Arthur Andersen.
10/05/00 C WHEELER	2.50	Review of confidentiality agreement; Conf with Mr. Herish; conf with Mr. Utley; conf with Mr. Buschbaum; arrange follow up with Mr. Lineberger
10/10/00 A LEVY	1.00	Matters re Confidentiality Agreement; patent issues.
10/11/00 C WHEELER	1.50	Conf with Mr. Utley re Ken Rubenstein and Time Warner; conf with Mr. Rubenstein
10/11/00 C WHEELER	1.50	Conf with Mr. Utley re Ken Rubenstein and Time Warner; conf with Mr. Rubenstein
CLIENT: IVIEWIT.COM, INC. November 30, 2000		
0894/40017-001 BRLIB1/283497 v1 11/30/00 08:56 AM (111111)		
This comment appears on no other billing pages, the date is strange and looks like it is covering something up		
10/26/00 C WHEELER	1.00	Conf with Mr. Prolow; conf with Mr. Utley; conf with Mr. Reed re trademark and copyright matters
10/31/00 C WHEELER	.50	Conf with Mr. Utley; conf with Mr. Rubenstein; Conf with Mr. Utley re financing
11/01/00 C WHEELER	.25	Conf with Mr. Utley re financing and re Mr. Rubenstein
11/07/00 C WHEELER	.75	Conf with Mr. Utley re financing; call to Mr. Assaf; conf with Mr. Utley re Mr. Rubenstein
11/29/00 C WHEELER	.25	Conf with Mr. Assaf; conf with Mr. Utley



Lorraine Christine Hoffman, Esq.
Assistant Staff Counsel
The Florida Bar
File No. 2003-51, 109(15C)

11/29/00 C WHEELER .50 Review of Cross Bow documents

11/29/00 M ROBBINS 3.00 Respond to e-mail from Rod Bell. Call to Ray Hersh re: Cross Bow transaction. Meeting with Ray Hersh. Meeting with Rocky Thompson re: Crossbow documents. Review D. Thompson's modifications to Cross Bow documents. Calls to Rod Bell. Modifications to Cross Bow documents pursuant to meeting with Ray Hersh. Preparation of correspondence to Rod Bell.

12/01/00 M ROBBINS 6.00 Review redlined revised documents from Rod Bell re: Cross Bow transaction. Preparation of additional modifications to Bell's draft of Securities Purchase Agreement, Investor Rights Agreement and Convertible Note. Telephone conferences with R. Hersh. Meeting with Rocky Thompson re: Cross Bow transaction; shareholders agreement, investor rights agreement, securities purchase agreement. E-mails to Hersh re: deliveries at closing. Correspondence to R. Bell. Draft and preparation of opinion letter. Preparation of Closing Checklist. Telephone conference with R. Hersh re: Disclosure Schedule. Inter-office conferences with Jill Zammis re: documents required for closing and preparation thereof. Preparation of closing documents.

12/08/00 D THOMPSON II 1.75 Follow-up on opinion matters; Conference with Attorney Mara Lerner Robbins re voting and conversion issues.

12/08/00 C WHEELER .25 Conf as to opinion and bridge loan

12/08/00 C WHEELER .50 Review of additional correspondence re opinion

12/08/00 M ROBBINS 7.25 Preparation of closing documents.

12/13/00 C WHEELER 1.00 Review opinion on iviewit closing

01/12/01 C WHEELER .50 Arrange for follow up on investigation; check on status of documentation for Prolow loan

01/18/01 G COLEMAN 3.25 Prepare risk factors. Review subscription documents. Inter-office conferences with M. Robbins.

01/22/01 C WHEELER .50 Conf with Mr. Utley re disclosure law and re license agreement

01/24/01 A LEVY .50 Additional attention to license agreement.



Lorraine Christine Hoffman, Esq.
Assistant Staff Counsel
The Florida Bar
File No. 2003-51, 109(15C)

01/25/01 M ROBBINS .75 Review and revise draft subscription agreement and risk factors.

01/26/01 A LEVY 1.00 Additional drafting re Greg Manning license.

01/30/01 C WHEELER .25 Follow up on license agreement; memo from Mr. Levy

01/30/01 K HEALY .50 Tc w/A. Levy re Iviewit Process License; research license Agmt. language for a process licensee
for M. Robbins.

01/30/01 A LEVY 1.50 Attention to license agreement.

01/31/01 C WHEELER .50 Conf with Mr. Levy re licensing agreement

01/31/01 A LEVY 2.50 Revisions to GM license agreement.

02/05/01 C WHEELER 2.50 Meeting as to structure of Internet train acquisition

02/05/01 C WHEELER .50 Correspondence re intellectual property follow up

02/08/01 A LEVY .50 Meeting with R. Hersh re GMA License Agreement.

02/12/01 A LEVY 1.75 Review cap table; TC with DE Secretary of State re Franchise Tax; TCs with R. Hersh and E. Lewin re same; OC with DET re same; revise and re-distribute draft of GMA License Agreement.

02/26/01 S KAPP .50 Conf. with CCW regarding matter involving dispute with PR person

02/26/01 A LEVY .50 Matters re proposed applet purchase.

03/02/01 A LEVY .25 OC with DET re applet purchase.

03/12/01 A LEVY 4.00 Matters re Apple Purchase Agreement.

03/13/01 D THOMPSON II 2.00 Follow-up on stock split, share exchange and gift matters; Meeting with Brian Utley and Ray Hersh re stock acquisition and asset acquisition.



Lorraine Christine Hoffman, Esq.
Assistant Staff Counsel
The Florida Bar
File No. 2003-51, 109(15C)

03/13/01 A LEVY 2.00 Matters re Apple Purchase Agreement.

03/14/01 D THOMPSON II 4.25 Prepare Acquisition Agreements; Telephone conference with Ray Hersh re same.

03/14/01 C WHEELER 1.00 Follow up on acquisition status; conf with Mr. Utley; receipt of note

03/14/01 A LEVY 1.00 Mtng with B. Utley and R. Hersh and preparation therefor.

03/15/01 D THOMPSON II 5.75 Prepare Asset Purchase Agreement and begin Plan of Exchange.

03/16/01 D THOMPSON II 4.75 Prepare ITrain Agreements for Agreement and Plan of Exchange.

03/19/01 D THOMPSON II 2.25 Meeting with Brian Utley and Ray Hersh re OP and Internet Train.

03/19/01 D THOMPSON II 2.75 Review OP and Internet Train documentation.

03/19/01 A LEVY .75 Matters re Stock Split; Apple Purchase Agreement.

03/20/01 C WHEELER .50 Review of status of acquisition documents

03/20/01 C WHEELER .50 Review of Agreement and Plan of Exchange; Review of Agreement for Purchase and Sale of Assets

03/20/01 J ZAMMAS 3.00 Work on closing checklist and preparation of Assignment and Assumption Agreement.

03/21/01 D THOMPSON II .75 Follow-up on ITrain and Original Productions deals.

03/21/01 C WHEELER .25 Review of Subscription correspondence to Tiedemann/Prolow



Lorraine Christine Hoffman, Esq.
 Assistant Staff Counsel
 The Florida Bar
 File No. 2003-51, 109(15C)

04/12/00 M ROBBINS 5.25 Telephone conference with Tom Wipman re: comments to Armstrong employment agreement. Telephone conference with Nantecon. Review Wipman's comments to Armstrong employment agreement. Preparation of additional comments to Armstrong employment agreement. Review Gruntal agreement terms. Preparation for meeting with B. Utley. Preparation of e-mail to B. Schiff re: patent/trademark office amendment filings. Meeting with Brian Utley re: various assignments. Inter-office conference with J. Zeman re: stock issuance to J. Gregg, executed Board consents. Telephone conference with Mantecon re: Gregg subscription agreement. Draft and preparation of memo to K. Realy re: trademark protection for logo and tag line. Inter-office conference with C. Wheeler re: trademark, pending matters. Telephone conference with G. Coleman re: logo and tag line.

04/18/00 M ROBBINS .50 Draft and preparation of memo to B. Utley re: Ryjo, Inc. Web Site Development Agreement. Telephone conference with G. Iantoni.

10/11/00 C WHEELER 1.50 Conf with Mr. Utley re Ken Rubenstein and Time Warner; conf with Mr. Rubenstein

PROSKAUER ROSELL P

02/21/00 D THOMPSON II 3.50 Prepare Confidentiality Note re confidentiality. non-conf agreements.

05/02/00 C WHEELER .25 Conf as to transfer

05/17/00 G REED .25 Phone w/ Examining Attorney re: PIO's misplaced amendment

06/02/00 G COLEMAN .25 Intellectual property matters.

07/10/00 C WHEELER .25 Conf with Mr. Bernstein re patents as collateral

07/27/00 C WHEELER 1.00 Conf with Mr. Utley re patents; conf with Mr. Bernstein re same

07/30/00 C WHEELER 1.00 Review of Warner's confidentiality agreement

07/31/00 C WHEELER 2.00 Meeting with Iviewit representatives re patent

09/29/00 C WHEELER 2.50 Conf with Mr. Prolow and Mr. Utley; conf. with Prolow, Utley, Hersch, Buschbaum, et al re technology;

08/03/00 G REED .50 Work re: trademark assignments

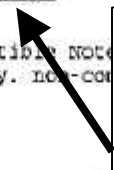

This marking is not on one submitted to bar a new one is??? See above 10/11/00 billing, looks like cover-up



Lorraine Christine Hoffman, Esq.
Assistant Staff Counsel
The Florida Bar
File No. 2003-51, 109(15C)

We also point the Bar to the billing records submitted for 1/99-1/00 where no Proskauer footers are attached, sample page from that period shows no billing or date footers as all Proskauer documents including others from that period that all do. The remaining bills from 01/2000 are all dated and file stamped. The significance of this is that the heart of the billing contention lies in the fact that Iviewit and its investors believed that the billings of Proskauer were going to patent and copyright protections and we are astonished that these earlier billings that are initially paid are nowhere in the corporate files and Proskauer has failed to provide them either to the client or the court where they are part of their own suit.

We submit the following from Wheeler deposition as to why the detail in the bills is now missing:



Lorraine Christine Hoffman, Esq.
Assistant Staff Counsel
The Florida Bar
File No. 2003-51, 109(15C)

52

1 A. Can I show you without examining all this?
2 I don't have - I mean --

3 Q. I want --

4 A. Can I show you? No, I can not show you.

5 Q. Well, is there anything in that Exhibit B
6 that you can point out to me that would show or
7 indicate that the services that are being sued on
8 apply to any other entity other than -- They're all
9 titled client name, iviewit.com, Inc., from what I
10 see.

11 MR. TRIGGS: Object to the form. Same
12 objection as stated previously in terms of basis
13 for it.

14 THE WITNESS: Do you want me to answer
15 this question?

16 MR. TRIGGS: Yeah. If you can answer the
17 question, absolutely.

18 A. Well, I don't have the detail provided
19 beyond this. I mean, I have the - I have the cover
20 pages, but I - I don't have - the detail is not on
21 there.

22 Q. Okay. So this is not actually a bill,
23 then. Is that what you're telling me?

24 A. No, it was a bill, but there were also
25 detailed pages, as you know, well know.

KEN SCHANZER & ASSOCIATES, INC. (954) 922-2660



Lorraine Christine Hoffman, Esq.
Assistant Staff Counsel
The Florida Bar
File No. 2003-51, 109(15C)

53

1 Q. So this was what, a summary sheet of a
2 bill?

3 A. This was the face page of the bill.

4 MR. TRIGGS: For the record, the reason
5 for attaching the face page rather than the
6 entire bill --

7 MR. SELZ: Well, it's actually --

8 MR. TRIGGS: -- is to preserve
9 attorney-client privilege issues when you are
10 filing a complaint against a client.

11 MR. SELZ: With regard to that, sir, and
12 obviously, you know, if you've got an objection,
13 Matt --

14 MR. TRIGGS: All I'm saying is, any
15 suggestion that the entire bill is not being put
16 out there for some purpose is just - it's flat
17 out wrong, and I just want to establish why it
18 was the way it was done.

19 MR. SELZ: You've got an opportunity on
20 cross to elicit whatever testimony you want from
21 him as to whatever was done.

22 MR. TRIGGS: Thanks, Steve.

23 MR. SELZ: Appreciate it.

24 Q. So with regard to this, sir, there is
25 nothing that you can show me on the face of any of

KEN SCHANZER & ASSOCIATES, INC. (954) 922-2660



Lorraine Christine Hoffman, Esq.
Assistant Staff Counsel
The Florida Bar
File No. 2003-51, 109(15C)

Mr. Triggs objection is flawed in his response to the question in that half the billing and detail is provided and the half that is critical is missing and what is there looks suspicious. Mr. Triggs appears to answer the question for Mr. Wheeler as if he were the deposer?

And further regarding missing bills:



Lorraine Christine Hoffman, Esq.
Assistant Staff Counsel
The Florida Bar
File No. 2003-51, 109(15C)

82

1 attached to the complaint is dated January 31st, 2000.

2 Looking at Exhibit B.

3 A. Okay. So what is the nature of your
4 question? I'm sorry.

5 Q. The nature of my question was --

6 A. I mean, there were bills before this.
7 There were - there were ones starting in June, I
8 believe, of 1999, and then you will have one of
9 August.

10 We didn't -- We commenced services in
11 January. We didn't bill them until June. So I mean,
12 our ledger sheets would show when they made payments.

13 Q. Okay. Because I'm looking at the same
14 statements again.

15 A. Okay.

16 Q. So you got that sheet that shows January
17 31st, 2000, invoice for eighty-five thousand three
18 fifteen fifty-four?

19 A. Okay.

20 Q. And the same date for an additional
21 \$1,300? Looks like disbursements and charges?

22 A. Right. Then the February statement.

23 Q. Then the February statement. And that
24 includes prior invoices for -- It's referencing
25 invoice dates from August --

KEN SCHANZER & ASSOCIATES, INC. (954) 922-2660



Lorraine Christine Hoffman, Esq.
Assistant Staff Counsel
The Florida Bar
File No. 2003-51, 109(15C)

83

1 A. August.
2 Q. -- September, October, December.
3 A. Right.
4 Q. The question I have is, do you know why
5 those invoices or summary sheets are not attached to
6 the complaint in this matter?
7 A. No.
8 Q. Do you know if Proskauer Rose is not
9 making any claims for sums due or sums due under those
10 prior invoices?
11 A. No. I don't know why they're not
12 attached.
13 Q. Now, the next funding that we talked about
14 was the Alpine Fund?
15 A. Correct.
16 Q. When did that take place?
17 A. Well, I - I think it was in the spring of
18 2000.
19 Q. And do you recall the amount of that
20 funding?
21 A. No, I don't. I think -- I don't.
22 Q. Did you prepare the transactional
23 documents for that?
24 A. Well, they were prepared under my
25 supervision, but we had specific - I mean, it would

KEN SCHANZER & ASSOCIATES, INC. (954) 922-2660



Lorraine Christine Hoffman, Esq.
Assistant Staff Counsel
The Florida Bar
File No. 2003-51, 109(15C)

And finally in his deposition he claims that not only can he not remember any of his billings but that he has no more comprehensive notes.

11 Q. Again, I know you have answered this, but
12 I just want to make sure, you don't have any more
13 comprehensive notes as to the services provided, other
14 than what's contained in these billing statements, is
15 that correct? You don't have a handwritten billing
16 statement that has a more complete description of the
17 services?
18 A. No, no, no. 

p.178 Wheeler Deposition

Further in this rebuttal we will provide deposition testimony whereby he cannot recall any information regarding any of the patent billings with he and Ken Rubenstein's name, we refer you to numerous examples of such avoidance and sudden memory loss throughout he and Mr. Rubenstein's depositions regarding these billings.

We now submit a page from hundreds prior to 1/2000 that have no Proskauer Rose official footer stamp, which makes them very suspicious:



Lorraine Christine Hoffman, Esq.
Assistant Staff Counsel
The Florida Bar
File No. 2003-51, 109(15C)

CLIENT: IVIEWIT CORPORATION
MATTER: GENERAL CORPORATE ADVICE
PAGE: 2

June 18, 1999

DATE	NAME	HOURS	DESCRIPTION
01/06/99	C WHEELER	1.50	Review of prospectus; conf as to nature of work
01/11/99	C WHEELER	.50	Response to Mr. Bernstein; conf with Mr. Gortz
01/12/99	C WHEELER	.50	Follow up on new corporation
01/12/99	R FOSTER	.25	Conference with Mara Lerner; preparation of corporate searches on IVIEWIT Corporation
01/13/99	C WHEELER	.50	Review details as to corporation
01/13/99	R FOSTER	1.00	Preparation of articles of incorporation, bylaws and organizational minutes for IVIEWIT Corporation
01/14/99	C WHEELER	.50	Follow up on status on intellectual property review and new incorporation
01/14/99	M ROBBINS	1.50	Revisions to Iviewit corporate formation documents. Telephone conferences with S. Bernstein and E. Bernstein re: formation of Iviewit. Inter-office conference with Wheeler re: same.
01/15/99	C WHEELER	.25	Conf as to status of corporation
01/22/99	M ROBBINS	.50	Preparation of revisions to Iviewit corporate formation documentation.
01/25/99	C WHEELER	.25	Check status of incorporation documents
01/26/99	L GARDNER	.50	Electronic filing of corporation.
01/26/99	R FOSTER	.25	Conference with Mara Lerner; telephone call with CT Corporation; preparation of facsimile transmission of designation of resident agent to Jennifer Forman
01/26/99	M ROBBINS	1.75	Revisions to Articles of Incorporation. Inter-office conference with Foster re: filing of Articles. Telephone conferences with Healy re: trademark and copyright matters. Preparation of memorandum to Wheeler re: same.
01/26/99	G GOLDMAN	1.00	Reviewing IVIEWIT's business plan for patentability opinion; conducting an on-line Internet search.

Missing footers 1/99 to 1/00



Lorraine Christine Hoffman, Esq.
Assistant Staff Counsel
The Florida Bar
File No. 2003-51, 109(15C)

And now a page from after 1/00 where it is obvious that the billing records of Proskauer normally have a footnote attached and from that point forward they do:



Lorraine Christine Hoffman, Esq.
 Assistant Staff Counsel
 The Florida Bar
 File No. 2003-51, 109(15C)

CLIENT: IVIEWIT.COM, INC.
 MATTER: GENERAL CORPORATE ADVICE
 PAGE: 2

February 17, 2000

DATE	NAME	HOURS	DESCRIPTION
01/03/00	D THOMPSON II	1.75	Conference re pending projects; prepare amendment to Emerald letter; Meeting with Brian Utley.
01/03/00	D THOMPSON II	2.00	Meetings re conversion issues; Huizenga exchange and structural issues; Follow-up re same.
01/03/00	C WHEELER	3.00	Board Meeting; follow up on restructuring
01/03/00	M ROBBINS	8.50	Inter-office conferences with Rocky Thompson re: modifications to Emerald Capital engagement letter. Telephone conference with Martha re: same. Inter-office conferences with Rocky Thompson and Gayle Coleman re: restructuring and documentation, share exchange agreement for Investech. Inter-office conferences with Jill Zammass re: minute books for new entities, restructuring documentation, foreign qualifications, fictitious name filings. Draft and preparation of Share Exchange Agreement. Inter-office conferences with Jill Zammass re: name change amendment for iviewit.com, Inc. Florida corporation. Review iviewit.com, Inc. organizational resolutions. Meeting with Rocky Thompson and Gayle Coleman re: restructuring matters, share exchange with Investech and offering memorandum. Draft and preparation of written consent of a majority of the Class A Members and managers re: dissolution of iviewit LLC. Revisions to Certificate of Cancellation. Review LLC Agreement re: authority to dissolve and required consent. Inter-office conference with Gayle Coleman re: furniture lease. Inter-office conferences with J. Zammass re: restructure documentation. Revise Share Exchange Agreement. Preparation of private offering memorandum for iviewit Holdings, Inc. modified to uvview.com, Inc. Multiple Inter-office conferences with Gayle Coleman re: dissolution and winding up of limited liability companies and preparation of dissolution documentation.

0894/40017-001 BRLIB1/256265 v1

02/17/00 03:48 PM (12129)

Normal footer on virtually all documents from Proskauer,
 Except earlier billings



Lorraine Christine Hoffman, Esq.
Assistant Staff Counsel
The Florida Bar
File No. 2003-51, 109(15C)

Other pages mysteriously missing footers after 1/00 include the following from the bills submitted to the Florida Bar:



Lorraine Christine Hoffman, Esq.
 Assistant Staff Counsel
 The Florida Bar
 File No. 2003-51, 109(15C)

8

IVIEWIT.COM, INC.
 2255 GLADES ROAD
 SUITE 330 WEST
 BOCA RATON, FL 33431-7360
 ATTENTION: MR. ELIOT E. BERNSTEIN

383449
 December 14, 2000

PROSKAUER ROSE LLP

2255 Glades Road
 Suite 330 West
 Boca Raton, FL 33431-7360

Employer Identification No. 13-184844

CLIENT NAME: IVIEWIT.COM, INC.
 MATTER NAME: TRADEMARK/GENERAL
 FILE #: 40017.0019

FOR LEGAL SERVICES RENDERED INCLUDING DISBURSEMENTS AND
 CHARGES INCURRED FOR THE PERIOD ENDED NOVEMBER 30, 2000
 AS SET FORTH IN THE ATTACHED PRINTOUT

8

TOTAL FEES: \$360.00

TOTAL DUE: \$360.00

OUTSTANDING INVOICES

DATE	INVOICE	AMOUNT	PAYMENTS	REMAINING BALANCE
01/25/00	342887	\$1,000.00	\$.	\$1,000.00
01/25/00	342836	\$881.64	\$.	\$881.64
03/15/00	349191	\$4,032.00	\$.	\$4,032.00
04/18/00	352753	\$2,238.50	\$.	\$2,238.50
07/21/00	363836	\$2,917.26	\$.	\$2,917.26
09/20/00	371505	\$165.00	\$.	\$165.00
11/17/00	380021	\$825.00	\$.	\$825.00

TOTAL OF PRIOR OUTSTANDING INVOICES: \$12,059.40

TOTAL OF CURRENT INVOICE: \$360.00

BALANCE DUE: \$12,419.40

8

and



Lorraine Christine Hoffman, Esq.
Assistant Staff Counsel
The Florida Bar
File No. 2003-51, 109(15C)

8

CLIENT: IVIEWIT.COM, INC.
MATTER: TRADEMARK/GENERAL
PAGE: 2

December 14, 2000

<u>DATE</u>	<u>NAME</u>	<u>HOURS</u>	<u>DESCRIPTION</u>
11/01/00	G REED	.25	Review and process incoming office actions for A SITE FOR SORE EYES (matters 30/31)
11/02/00	G REED	.25	Ltr. Brian Utley re: tm office actions
11/03/00	G REED	.50	Review and process several incoming filing receipts and add'l office actions

SUMMARY OF HOURS

<u>NAME</u>	<u>HOURS</u>
GREGG REED	1.00
TOTAL FOR ASSOCIATE	1.00

TOTAL HOURS: 1.00

8

8



Lorraine Christine Hoffman, Esq.
Assistant Staff Counsel
The Florida Bar
File No. 2003-51, 109(15C)

and

CLIENT: IVIEWIT.COM, INC.
MATTER: IVIEWIT/42/US
PAGE: 2

January 11, 2001

DATE	NAME	HOURS	DESCRIPTION
12/26/00	B SCHIFF	.75	Correcting Recordal of Change of Name and filing with PTO.

SUMMARY OF HOURS

NAME	HOURS
BARBARA SCHIFF	.75
TOTAL FOR LEGAL ASSISTANT	.75
TOTAL HOURS:	.75

DISBURSEMENTS AND CHARGES

DESCRIPTION:	AMOUNT
GOVERNMENT FEES	215.00
TOTAL DISBURSEMENTS AND CHARGES FOR THIS MATTER:	\$215.00



Lorraine Christine Hoffman, Esq.
 Assistant Staff Counsel
 The Florida Bar
 File No. 2003-51, 109(15C)

 IVIEWIT.COM, INC. 386159
 2255 GLADES ROAD January 11, 2001
 SUITE 340 WEST
 BOCA RATON, FL 33431-7360
 ATTENTION: MR. ELIOT I. BERNSTEIN

PROSKAUER ROSE LLP 2255 Glades Road
 Suite 340 West
 Boca Raton, FL 33431-7360 Employer Identification No. 13-194084

CLIENT NAME: IVIEWIT.COM, INC.
 MATTER NAME: IVIEWIT/42/US
 FILE #: 40017.0011

FOR LEGAL SERVICES RENDERED INCLUDING DISBURSEMENTS AND
 CHARGES INCURRED FOR THE PERIOD ENDED DECEMBER 31, 2000
 AS SET FORTH IN THE ATTACHED PRINTOUT



TOTAL FEES:	\$97.00
DISBURSEMENTS AND CHARGES:	\$215.00
TOTAL DUE:	\$312.00

TOTAL OF CURRENT INVOICE: \$312.00



All these missing Proskauer Rose footer stamps lead one to believe that document tampering is occurring since these documents all regard important dates and events



Lorraine Christine Hoffman, Esq.
Assistant Staff Counsel
The Florida Bar
File No. 2003-51, 109(15C)

and in fact come in between hundreds of pages that do, we urge the Florida Bar to look at volume of bills attached and see the inconsistency as they appear.

We further submit evidence gathered from the depositions of Rubenstein, Wheeler and Utley.

From the Rubenstein deposition:

1 Rubenstein

2 Q. Do you have any information at all
3 with regard to any of the IViewIt entities?

4 A. Not at this time, no.

5 Q. "Not at this time." Did you have
6 any information at any time in the past, sir?

7 A. Not that I know of right now.

8 Q. Do you have any files or records
9 indicating that you had any dealings with --
10 and I will go through a list here --

11 IViewIt.com, Inc.?

12 A. Not that I know of.

13 Q. IViewIt, LLC?

14 A. Not that I know of.

15 Q. UViewIt?

16 A. Not that I know of.

17 Q. IViewIt, Inc.?

18 A. Not that I know of.

→ 19 Q. Have you ever heard of an
20 individual named Eliot Bernstein?

21 A. I might have.

22 Q. Well, sir, that's either a "Yes"
23 or "No" question.

→ 24 A. Like I said, I think he works for
IViewIt, and I may have heard his name.



Lorraine Christine Hoffman, Esq.
Assistant Staff Counsel
The Florida Bar
File No. 2003-51, 109(15C)

From a letter authored by Mr. Rubenstein to Eliot Bernstein on how we were going to draft applications for patents we submit the following evidence whereby Ken Rubenstein acknowledges having spoken to Eliot Bernstein and is sending information to Mr. Bernstein to aid in the drafting of the patent applications, no billing records reflect this transfer of documents and the package contained hundreds of pages of patent samples collected by Mr. Bernstein and send overnight mail, yet it was free, as were all of the hours in the billing record for Mr. Rubenstein:



Lorraine Christine Hoffman, Esq.
 Assistant Staff Counsel
 The Florida Bar
 File No. 2003-51, 109(15C)

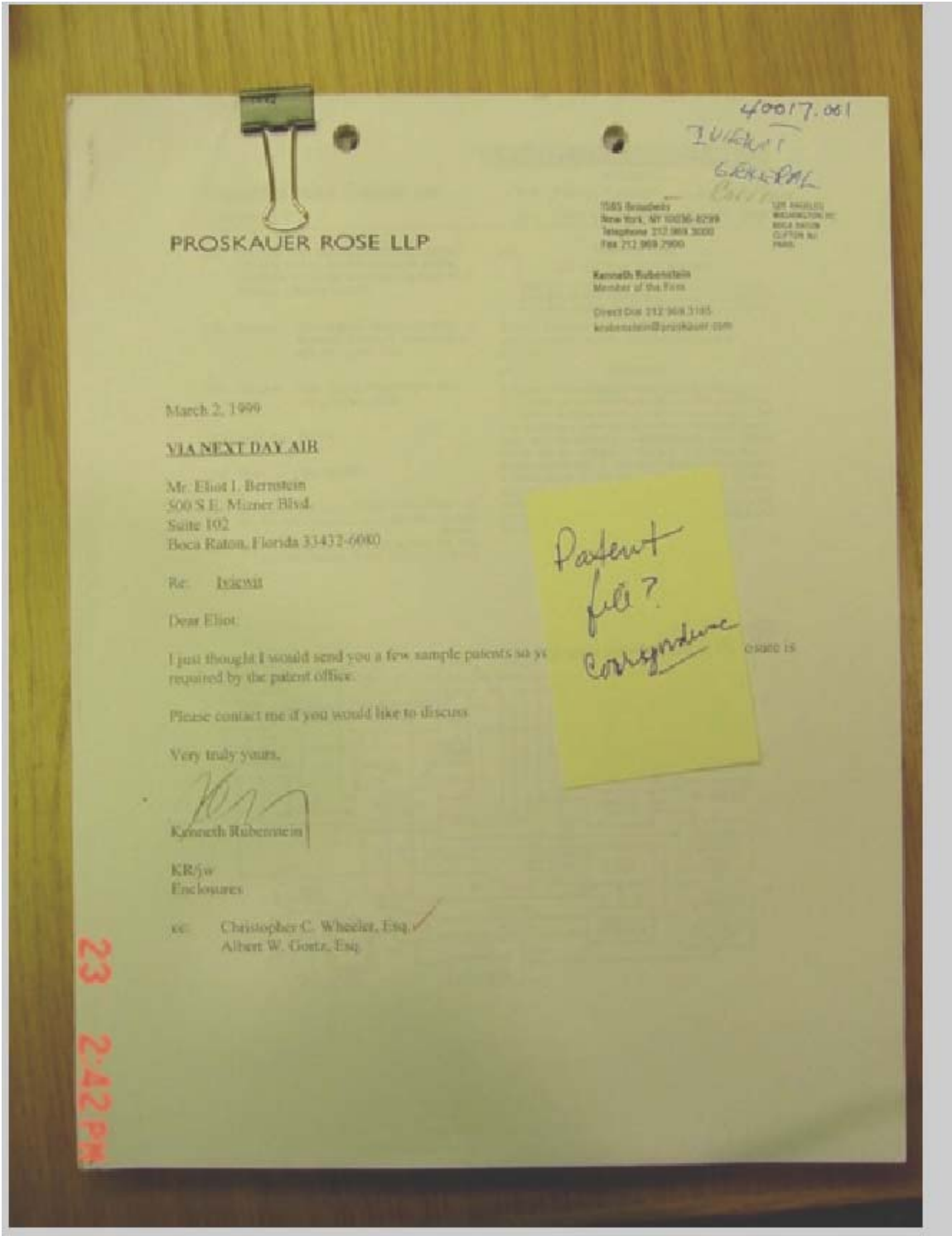



Lorraine Christine Hoffman, Esq.
Assistant Staff Counsel
The Florida Bar
File No. 2003-51, 109(15C)

THIS DOCUMENT IS MISSING FROM THE COMPANY RECORDS BUT FOUND IN THE PROSKAUER DOCUMENTS! THE LETTER CLEARLY SHOWS KEN IS HELPING US IN THE DRAFTING OF OUR PATENTS.

And again from Rubenstein's deposition in the first section Rubenstein states that he does not do patent prosecution and therefore referred the matter to Raymond Joao, yet he fails to mention that the entire Meltzer patent group had transferred with him to Proskauer and they do patent prosecution. Simply go to www.uspto.gov and do a search for Proskauer, what you will find is that since meeting Iviewit they have filed many patents and prior to Iviewit they had virtually none:



Lorraine Christine Hoffman, Esq.
Assistant Staff Counsel
The Florida Bar
File No. 2003-51, 109(15C)

7 A. Like I say, I was not in any way
8 involved with getting patents for IViewIt.
9 Q. What were you involved with, if
10 you were, with IViewIt?
11 A. The only thing I did for IViewIt
12 is I referred them to another patent lawyer.
13 Q. And who is that?
14 A. A guy named Ray Joao.
15 Q. And where did Mr. Joao work?
16 A. I believe he was working at the
17 time at my former law firm, Meltzer Lippe.
18 Q. And what date was this?
19 A. I don't recall.
20 Q. So, you were employed by Proskauer
21 Rose at this time?
22 A. Yes.
23 Q. And you referred IViewIt to
24 Meltzer Lippe?
25 A. I referred IViewIt to Ray Joao,
1 Rubenstein
2 who I believe was working at Meltzer Lippe at
3 that time.
4 Q. Who did you speak to at IViewIt,
5 sir?
6 A. I don't recall.
7 Q. Did you keep any notes of your
8 conversation with regard to this referral?
9 A. No.
10 Q. Did you speak to Mr. Joao with
11 regard to this referral?
12 A. I don't recall.
13 Q. Why did you refer this matter to
14 Meltzer Lippe?
15 A. Because it wasn't work I wanted to
16 undertake myself.
17 Q. And why was that?
18 A. Because I am not generally in the
19 patent prosecution business, in most cases.
20 Q. Did you ever meet with any members
21 of the board of directors of IViewIt.com?
22 A. Not that I know of.
23 Q. Were you ever involved in any
24 meetings with anyone concerning IViewIt.com?
25 A. No, not that I know of.

And further from Rubenstein's deposition



Lorraine Christine Hoffman, Esq.
Assistant Staff Counsel
The Florida Bar
File No. 2003-51, 109(15C)

3 Q. Did you ever have any discussions
4 with anyone at Proskauer Rose concerning the
5 IViewIt Technologies?
6 A. Not that I recall.
7 Q. Did you have any discussions with
8 anyone -- let's say Chris Wheeler,
9 particularly, at Proskauer Rose with regard to
10 anything at IViewIt?
11 A. I might have, but I don't recall
12 anything about it at this time, if I did.
13 Q. Did you ever counsel anyone at
14 IViewIt concerning any matters regarding the
15 patent or patent applications?
16 A. Not that I recall.
17 Q. Did you keep any files yourself
18 with regard to IViewIt and any communications
19 with IViewIt?
20 A. I don't think so, no.
21 MR. PRUSASKI: Objection, asked
22 and answered.
23 Q. Did you ever play a role as an
24 advisory board member for IViewIt?
25 A. Not that I know of, no.
1 Rubenstein
2 Q. Well, sir, I am a little
3 confused. You normally would recall that you
4 would be on a board of directors --
5 A. I don't think I was on any such
6 board.
7 To my knowledge, I was on no such
8 board.
9 Q. And you never had any
10 communications with any board member from
11 IViewIt; is that a correct characterization --
12 A. I had a -- probably a phone call
13 or two with Brian Utley. I am not sure if
14 he's a board member or not.
15 Q. And what were the contents of your
16 conversation with Mr. Utley?
17 A. I don't recall.
18 Q. Did you ever talk to anyone at
19 Warner Bros. with regard to IViewIt?
20 A. You are asking for privileged
21 information, sorry.
22 Q. Well, whether or not you had
23 communications --
24 A. No, you are asking for the content
25 of communications.
1 Rubenstein
2 Q. No, I am not asking for the
3 content.
4 A. Yes, you are.
5 Q. Please listen to my question.
6 MR. PRUSASKI: Mr. --
7 Q. The question was, did you ever
8 discuss any matters concerning IViewIt with

Confide

4/30/2003

And further from Mr.



Lorraine Christine Hoffman, Esq.
Assistant Staff Counsel
The Florida Bar
File No. 2003-51, 109(15C)

9 anyone from Warner Bros., period. I am not
10 asking you for the content because, clearly,
11 if you want to assert a claim of privilege on
12 that, and Warner Bros. is a client of yours,
13 then you can assert it, but I am asking you
14 whether or not you had any discussions at
15 all. I am not asking you for the contents.

16 A. I am --

17 MR. PRUSASKI: Mr. Selz, I am
18 going to object. I am instructing
19 Mr. Rubenstein not to answer. It's
20 privileged attorney/client
21 communication.

22 (DIRECTION NOT TO ANSWER.)

23 MR. SELZ: Not the fact of whether
24 or not he had any discussions --

25 MR. PRUSASKI: I am not arguing.
1 Rubenstein

2 We are not allowed, under the Florida
3 rules, to argue objections. I am
4 instructing him not to answer.

5 MR. SELZ: I understand.

6 MR. PRUSASKI: And I can't argue
7 with you.

8 MR. SELZ: Just so the record is
9 clear, your objection is it's
10 privileged, whether or not he even spoke
11 to Warner Bros.

12 MR. PRUSASKI: Yes, about IViewIt.

13 MR. SELZ: About IViewIt.

MR. PRUSASKI: Yes.

Rubenstein's deposition



Lorraine Christine Hoffman, Esq.
Assistant Staff Counsel
The Florida Bar
File No. 2003-51, 109(15C)

7 Q. Have you ever met with Mr. Chris
8 Wheeler?
9 A. I don't think I ever met him, no.
10 Q. Did you ever speak with him?
11 A. Possibly, yes.
12 Q. Do you have any specific
13 recollection as to when you spoke with him?
14 A. No.

15 Q. Have you ever billed any services
16 to IViewIt or any of the IViewIt entities?

17 A. As far as I know, I have not.

18 Q. Have you been included on a
19 billing statement for IViewIt --

20 A. As far as --

21 Q. -- on Proskauer Rose.

22 A. As far as I know, I have not.

23 Q. Did Mr. Wheeler ever consult with
24 you, to the best of your recollection, with
25 regard to any issues concerning IViewIt?

43
1 Rubenstein

2 A. He might have, but I would not
3 recall the details at this time.

4 Q. Would you have taken any
5 contemporaneous notes of those conversations?

6 A. Probably not.

7 Q. Would you keep any other records
8 of those conversations?

9 A. I am not a big note taker of phone
10 conversations, so the answer would be no.

11 Q. Would those conversations have
12 been reflected in any billing records that you
13 might keep?

14 A. Like I say, to my knowledge, I
15 never billed any services to IViewIt.

16 Q. Well, I don't think that was my
17 question.

18 My question was, sir, if you did
19 have a conversation with Christopher Wheeler
20 with regard to IViewIt, would it have been
21 reflected on your billing records?

22 A. Probably not, because it would
23 have been a minor short conversation.

24 Q. Did you ever come down to Florida
25 to meet with anyone from IViewIt?

44
1 Rubenstein

2 A. No.

3 Q. Did you ever make any
4 representation to any party that you can
5 recall with regard to IViewIt or its
6 technologies?

7 A. Not that I recall.

8 MR. PRUSASKI: Object to the form.

9 Q. Let me rephrase that. Have you
10 ever spoken to any third party with regard to



Lorraine Christine Hoffman, Esq.
Assistant Staff Counsel
The Florida Bar
File No. 2003-51, 109(15C)

11 IViewIt's technologies?

12 A. Not that I recall at this time.

13 Q. Did you ever meet with anyone
14 named Stephen Filipek?

15 A. I don't know who he is.

16 Q. Were you ever included in any
17 business plan of IViewIt as a consultant or
18 any other representation as being involved
19 with the company?

20 → A. Not that I know of at this time.

21 Q. If you were included on that
22 business plan as a consultant or advisor to
23 IViewIt, would you have consented to that or
24 would you have had to have consented to that?

25 → A. I don't know whether I would have

45

1 Rubenstein
2 had to consent to it or not, and I don't know
3 if I would have consented or not.

4 Q. Have you ever seen a business plan
5 for IViewIt?

6 → A. I don't know, I might have. I
7 might not have, I don't know.

8 Q. How about, did you ever speak to
9 anyone at Brian Utley?

10 A. I did have one or two phone
11 conversations with him.

12 Q. With regard to IViewIt?

13 A. Yes.

14 Q. And what were the contents of
15 those conversations?

16 A. I --

17 MR. PRUSASKI: Asked and answered.

18 MR. SELZ: I'm sorry.

19 A. And I will just answer it again,
20 for convenience, I don't know the details at
21 this point in time.

And further Rubenstein deposition testimony and I remind you that this is a guy who said he never heard of us and therefore needed not to be deposed.



Lorraine Christine Hoffman, Esq.
Assistant Staff Counsel
The Florida Bar
File No. 2003-51, 109(15C)

24 Q. Who recommended that IViewIt go to
25 Meltzer Lippe for their patent work?

1 Rubenstein

2 A. I probably suggested it.

3 Q. And was that suggestion
4 communicated in writing?

5 A. Probably not.

6 Q. And, if you can recall, who did
7 you communicate with at IViewIt concerning
8 your recommendation?

9 A. I don't recall.

10 Q. Did you ever meet with Eliot
11 Bernstein?

12 I think you might have said that
13 you never met with him before.

14 A. I don't think I ever met with him.

15 Q. Okay, and you said you don't know
16 who Jude Rosario is; correct?

17 A. Correct.

18 Q. And you don't know who Zackirul
19 Shirajee is; correct?

20 A. Correct.

21 Q. How about Jeffrey Friedstein?

22 A. I don't know who he is.

23 Q. Are you aware of whether or not
24 Proskauer Rose accepted any stock from
25 IViewIt?

1 Rubenstein

2 A. I would have no knowledge of that.

3 Q. Were you ever asked to evaluate
4 for Proskauer Rose the inventions that IviewIt
5 had?

6 A. Not that I recall, no.

And



Lorraine Christine Hoffman, Esq.
Assistant Staff Counsel
The Florida Bar
File No. 2003-51, 109(15C)

further Rubenstein deposition testimony

11 Q. Are you aware of any of the
12 billings that Proskauer Rose presented to
13 IViewIt for services?
14 A. To my knowledge, I have never seen
15 any such bill.
16 Q. Did you have any discussions with
17 any other partner or associate at Proskauer
18 Rose concerning the billings to IViewIt?
19 A. Not that I could recall.
20 Q. Okay. When I refer to "IViewIt",
21 I mean --
22 A. You mean all of those entities.
23 Q. Correct.
24 A. And the answer is, not that I
25 could recall.
1 Rubenstein
2 Q. Did Mr. Wheeler talk with you at
3 all about any infringement problems or patent
4 rights at IViewIt?
5 A. Not that I recall.

From Wheelers deposition:

20 Q. And it says specifically, and I quote,
21 since there seems to be some confusion as to what Ken
22 needs in order to determine the patentability of your
23 process?
24 A. Right.
25 Q. I'm arranging a conference call between



Lorraine Christine Hoffman, Esq.
Assistant Staff Counsel
The Florida Bar
File No. 2003-51, 109(15C)

1 | you, me and Ken in which we can discuss it.

2 | A. Right.

3 | Q. So was that statement on your part in this
4 | letter precipitated by some specific discussion with

5 | Mr. Bernstein?

6 | A. I don't recall.

Wheeler deposition p.37-38

And again from Wheeler regarding patent calls to Rubenstein, who the Company reminds you claims he had NOTHING to do with Iviewit and this is also evidenced in his response to the NY Bar.



Lorraine Christine Hoffman, Esq.
Assistant Staff Counsel
The Florida Bar
File No. 2003-51, 109(15C)

3 Q. How about on 2/16/99, .25, conference with
4 Mr. Bernstein, call to Mr. Rubenstein. Is that Ken
5 Rubenstein?

6 → A. Yes.

7 Q. Can you recall what you spoke to
8 Mr. Rubenstein about?

9 → A. No.

10 Q. I didn't think so. How about the next two
11 entries down, 2/17/99, .25, call to Mr. Rubenstein re:
12 → patent advice?

13 A. Right.

14 MR. TRIGGS: What's your question?

15 Q. Do you recall what that entry involves or
16 what - what you would explain to Mr. Rubenstein about
17 with regard to patent advice?

18 A. It would be logistics, once again. ?

19 Q. Now, by logistics you mean --

And more from Rubenstein deposition



Lorraine Christine Hoffman, Esq.
Assistant Staff Counsel
The Florida Bar
File No. 2003-51, 109(15C)

16 Q. Are you aware, sir, that your name
17 is referenced in billing statements from
18 Proskauer Rose to IViewIt more than a dozen
19 times?
20 A. No, I am not.
21 MR. PRUSASKI: Object to the form.
22 Q. Can you think of any reason, sir,
23 why your name would be mentioned more than a
24 dozen times in billing statements from
25 Proskauer Rose to IViewIt?
1 Rubenstein
2 A. I had a few conversations with
3 different people about the company over time,
4 as I have testified.
5 Q. And you testified that the
6 conversations took place between you and Chris
7 Wheeler and you and Brian Utley.
8 A. Right.
9 Q. Correct?
10 A. Possibly -- I don't know if there
11 was anyone else.
12 Q. Do you have any recollection now
13 as to any other conversations?
14 A. No.
15 Q. Now, with regard to E-mails, were
16 you aware of any E-mails that you received
17 from anyone concerning IViewIt?
18 A. I don't know at this point in
19 time.
20 Q. Do you have records of E-mails
21 that you received?
22 A. I would not know at this point in
23 time.
24 Q. Are they normally kept as part of
25 your files?
1 Rubenstein
2 A. I don't know at this point in
3 time.
4 Q. I had asked you previously, sir,
5 whether or not you had any information on
6 Mr. David Colter.
7 Do you recall that?
8 A. Yes, and I said I wasn't sure who
9 he was, and I suggested you might want to
10 refresh my recollection, and you declined to
11 do so.
12 Q. Okay. Would it refresh your
13 recollection, sir, if I tell you that
14 Mr. Colter was with Warner Bros.?
15 A. You know, I may have heard the
16 name, but I don't think I ever had any
17 dealings with him, although I am not sure.
18 Q. But you do have dealings with
19 Warner Bros.; is that correct?
20 A. Like I said, Warner Bros. is a
21 client.



Lorraine Christine Hoffman, Esq.
Assistant Staff Counsel
The Florida Bar
File No. 2003-51, 109(15C)

22 Q. Right. Would there be any reason
23 why your name would be mentioned in E-mails,
24 that you can think of, from Warner Bros. To
25 someone at AOL?

1 Rubenstein

2 A. I don't know.

3 I mean, I do work -- they are part
4 of the same company, they are clients of the
5 firm, and so, I can't really discuss it
6 because of privilege.

7 Q. Sir, you had indicated earlier you
8 had no idea with regard to any of the
9 intellectual properties or patents for
10 IViewIt; is that correct?

11 A. Not at this point in time.

12 Q. Did you ever issue any opinion to
13 anyone as to the validity of those patents?

14 A. Not that I know of.

15 Q. Did you ever provide any
16 information at all with regard to the validity
17 of any of these patents?

18 A. Not that I know of.

19 Q. So it's possible that you have in
20 the past but you don't recall?

21 A. I don't recall having involvement
22 with these patents. I was not the patent
23 counsel.

And more from Rubenstein's deposition



Lorraine Christine Hoffman, Esq.
Assistant Staff Counsel
The Florida Bar
File No. 2003-51, 109(15C)

11 Q. Do you have any idea what
12 Mr. Wheeler's specialization is?
13 A. No.
14 Q. Have you ever spoken with him with
15 regard to the legal services he was providing
16 to IViewIt?
17 A. You asked me that --
18 MR. PRUSASKI: Asked and
19 answered.
20 A. -- already and I answered it.
21 Q. And what was your answer again,
22 sir, "No"?
23 A. I don't remember the exact
24 question you asked, so I don't remember the
25 exact wording of my answer, what the question
79
1 Rubenstein
2 was -- but the question was asked and
3 answered.



Lorraine Christine Hoffman, Esq.
Assistant Staff Counsel
The Florida Bar
File No. 2003-51, 109(15C)

X. Rubenstein and Wheeler as Advisors to the Board of Iviewit, included in business plans authored, reviewed, billed for and disseminated by Mr. Wheeler and Utley. The plans are relied upon by all investors in Iviewit when considering the efficacy of the patents and Rubenstein is continually referred to as “retained” by Iviewit to oversee the patent pool for Iviewit.

And further to refute Mr. Rubenstein’s deposition testimony we will provide clear examples that Mr. Rubenstein was on the Advisory Board in almost all business plans and we attach a Wachovia Securities Private Placement Memorandum as [Exhibit C](#) that Mr. Utley and Mr. Wheeler authored and Utley signed sworn statements as to the accuracy and Mr. Wheeler billed for his reviews, wherein Rubenstein is listed as an Advisor to the Board. We will also illustrate that Mr. Rubenstein was sent these business plans for review.

It will also become apparent that Mr. Rubenstein and Mr. Thagard of Warner Bros. have a common interest in the DVD patent pool overseen by Rubenstein and Mr. Thagard holds @ 13 essential patents as deemed by Rubenstein to be essential and this COI was never prior exposed to Iviewit. Mr. Rubenstein acted as the main reviewer of Iviewit’s technology for Warner Bros. Mr. Thagard was for a period an Advisory Board member himself. Rubenstein and Thagard are friends and it will be illustrated throughout that they had opined together to other Warner Bros. representatives as to the Iviewit patents and their strengths.



Lorraine Christine Hoffman, Esq.
Assistant Staff Counsel
The Florida Bar
File No. 2003-51, 109(15C)

24 Q. Again, sir, this letter refers to
25 you being on the advisory board of IviewIt
83
1 Rubenstein
2 between fall of 1999/spring of 2000.
3 A. I was never on any advisory board
4 of IViewIt.
5 Q. Did Stephen Lamont ever meet with
6 you in person?
7 A. I think I -- as I testified, I may
8 have had a conversation with him, I don't know
9 if it was in person or not.
10 Q. You previously testified that you
11 had never reviewed any of IViewIt's
12 technologies; is that correct?
13 A. I never testified to that. What I
14 told you is, I don't have any knowledge of it
15 right now.
16 Q. Okay.
17 A. I don't know whether I reviewed it
18 or not.
19 Q. So it's possible, then, sir, that
20 you did review it.
21 A. Like I said, I answered the
22 question. You asked me, I answered it. I
23 don't know whether I reviewed it or not. I
24 have no knowledge of it right now. I was not
25 their patent attorney, I was not involved with
84
1 Rubenstein
2 their patents.
3 Q. Okay, if you don't have a
4 recollection of reviewing it, but then it's
5 possible that you had; is that correct?
6 MR. PRUSASKI: Anything's
7 possible. I think we could stipulate to
8 that.
9 A. Right, I don't think it's possible
10 but -- and I don't think it happened.
11 Q. Do you have any clearer
12 recollection of it because of this letter?
13 A. No, I don't have a detailed
14 recollection or any recollection of it at this
15 point in time.
16 Q. And, again, I think you had
17 testified that you don't know anyone -- Greg
18 Thagard, you don't know Greg Thagard?
19 A. I do know Greg Thagard.
20 Q. Who is Greg Thagard?
21 A. He used to work at Warner Bros.
22 Q. Does Mr. Thagard, to the best of
23 your knowledge, have any information
24 concerning IViewIt?
25 A. I don't know at this point in
85
1 Rubenstein



Lorraine Christine Hoffman, Esq.
Assistant Staff Counsel
The Florida Bar
File No. 2003-51, 109(15C)

2 time.
3 Q. What, to the best of your
4 recollection, was Greg Thagard's role with
5 regard to IViewIt?
6 A. I don't know what he might or
7 might not have done with respect to IViewIt.
8 Q. Who is Greg Thagard?
9 A. He is a person who worked at
10 Warner Bros.
11 Q. Well, what was his position --
12 A. He was in technical -- in the
13 technology side of the company.
14 Q. Do you have any idea where
15 Mr. Thagard is currently?
16 A. No. I believe he left the
17 company.
18 Q. How about Chris Cookson, did you
19 ever have any conversations with Chris Cookson
20 concerning IViewIt Technologies?
21 A. Like I say, Chris Cookson works
22 for Warner Bros., and any conversations I had
23 with Warner Bros. are privileged. So, I am
24 not saying I had a conversation, I am not
25 saying I did not have a conversation, I am
86
1 Rubenstein
2 saying you are asking for privileged material.
3 Q. And David Colter?
4 A. I am not sure I ever had any
5 dealings with him.
6 Q. And who is David Colter?
7 A. You asked and I answered that
8 question already.

Although Respondents response uses Mr. Utley's testimony to defend that Mr. Rubenstein was never involved in the patents, we submit to the Florida Bar Mr. Utley's letter to the Board of Directors that directly contradicts his sworn testimony and claims that as an Advisor to the Board on patents he counseled Mr. Rubenstein regarding patent issues. Based on Mr. Rubenstein's advice Utley then took actions that directly hurt the Company's position with including but not limited to Warner Bros., AOLTW and Sony.

Mr. Utley had also been told by David Colter the senior Iviewit representative of Warner Bros. never to contact members of the AOLTW/WB staff other than himself after Utley was caught lying about his background with Senior Technologists at Universal/Vivendi). But despite this request by Mr. Colter, Mr. Rubenstein as illustrated directed him to send highly confidential and private patent documents to many members of the WB/AOTW group in a direct attempt to hurt the Company. Mr. Utley's letter should be enough direct evidence to start the Florida Bar to investigate these allegations, as they illustrate direct



Lorraine Christine Hoffman, Esq.
Assistant Staff Counsel
The Florida Bar
File No. 2003-51, 109(15C)

perjured statements by Utley, Rubenstein and Wheeler in regards to Rubenstein as an advisor to Iviewit.

When WB/AOTW representatives then wanted to talk to Mr. Rubenstein regarding these documents and to verify his work and his prior discussions he had with representatives of Warner Bros. that were critical to procuring an I View It/WB relationship, Rubenstein claimed he could not opine on Iviewit technologies due to a COI. This led to the end of the relationship with Warner Bros. and interfered with a proposed investment of \$20M with AOLTW.

We submit as evidence

Subject: FW: Minutes of the Board Meeting of April 14, 2001

-----Original Message-----

From: Brian G. Utley [mailto:brian@iviewit.com]

Sent: Wednesday, April 18, 2001 11:17 AM

To: Eliot I. Bernstein; 'simon@adelphia.net'; 'kanderson@myCFO.com'; 'dg_kane@msn.com';

'glewin@goldsteinlewin.com'; 'hankpow@gate.net'; 'bprolow@tiedemannfunds.com'; Maurice Buchsbaum

Cc: 'Christopher C. Wheeler (E-mail)'

Subject: RE: Minutes of the Board Meeting of April 14, 2001

I was advised by Proskauer Rose that anyone who was in an active due diligence stage and who was reviewing our intellectual property as part of that due diligence should receive a copy of the examiners opinion. Therefore the opinion was forwarded to the same people who have received copies of the patent filings namely, Warner Brothers and Irell & Manella. Ken Rubenstein, as our advisor, was also copied. Your father suggested that, because of the importance of our intellectual property, our own Board of Directors should be aware of the current status of our applications. With respect to Irell & Manella, it is quite likely that we will need to engage them or some other alternative counsel in order to respond to the opinion. I have a copy of Alvear's book if you need it.



Lorraine Christine Hoffman, Esq.
Assistant Staff Counsel
The Florida Bar
File No. 2003-51, 109(15C)

-----Original Message-----

From: **Eliot I. Bernstein** [mailto:eliot.bernstein@verizon.net]
Sent: Thursday, January 03, 2002 3:35 AM
To: '[David J. Colter \(E-mail\)](mailto:David.J.Colter@verizon.net)'; '[David J. Colter \(E-mail 2\)](mailto:David.J.Colter@verizon.net)'
Subject: FW: [Ken Rubenstein](#)

-----Original Message-----

From: PSLamont39@aol.com [mailto:PSLamont39@aol.com]
Sent: Thursday, January 03, 2002 3:24 AM
To: eliot.bernstein@verizon.net
Subject: Re: [Ken Rubenstein](#)

In a message dated 1/2/02 10:53:13 PM Eastern Standard Time, eliot.bernstein@verizon.net writes:

| Is he willing to speak to Time Warner?

No, he is unwilling to speak to Time Warner. He states that it would be a conflict of interest for him, as they are a major client in his New York office. Perhaps when he spoke with them before, they were not a major client.

PSL

And then from Mr. Rubenstein's deposition:



Lorraine Christine Hoffman, Esq.
Assistant Staff Counsel
The Florida Bar
File No. 2003-51, 109(15C)

13 Q. Are you aware of any conflict of
14 interest between IViewIt and any of your own
15 clients?
16 A. No.
17 MR. PRUSASKI: What's the
18 relevancy of that, Mr. Selz?
19 MR. SELZ: I think it goes to
20 whether or not IViewIt should have been
21 represented by Proskauer Rose in the
22 first place.
23 MR. PRUSASKI: Oh, is that a new
24 theory that you haven't pled?
25 MR. SELZ: Is that an objection?
72
1 Rubenstein
2 MR. PRUSASKI: Yes, it's objection
3 to relevance.
4 MR. SELZ: Okay, so noted for the
5 record.
6 Q. Mr. Rubenstein, you had indicated
7 that you are not aware of any conflicts
8 between IViewIt and any of your other clients;
9 is that correct?
10 A. Not at this point in time, no.
11 Q. Were you aware of any conflicts in
12 the past?
13 A. Not that I know of.
14 Q. Would there be any records kept of
15 any conflict check that was run by Mr. Wheeler
16 or any other --
17 A. I don't know.
18 Q. Would you let me finish my
19 question, please.
20 -- Mr. Wheeler or any other
21 partner or associate of your firm.
22 A. I don't know what records there
23 might be.
24 Q. You indicated there was a conflict
25 committee. Does that conflict committee meet
73
1 Rubenstein
2 in New York or do they meet in Florida or is
3 there any particular location for their
4 meetings?
5 MR. PRUSASKI: Objection,
6 relevance.
7 You can answer this question, but
8 it's not going to get much further.
9 A. I assume they meet in New York.
10 Q. Is there any particular reason for
11 that assumption?
12 A. Most of the law firm is in
13 New York.
14 Q. Sir, I am a little confused about
15 some of your earlier testimony. I had asked
16 you whether or not you had spoken with any of



Lorraine Christine Hoffman, Esq.
Assistant Staff Counsel
The Florida Bar
File No. 2003-51, 109(15C)

17 your clients concerning IViewIt and its
18 technology, and your response was to claim
19 privilege. Is that still the case, you are
20 claiming privilege with regard to any of those
21 communications?

22 MR. PRUSASKI: Yes.

23 A. Yes.

24 Q. Okay. I am going to just say at
25 this point that you testified that there were

74

1 Rubenstein
2 only two occasions that you had spoken with
3 third parties Mr. Utley and Mr. Wheeler that
4 you can recall with regard to IViewIt; is that
5 correct?

6 MR. PRUSASKI: I don't recall that
7 being his testimony.

8 A. That's not my testimony.

9 Q. What was your testimony?

10 A. We will have to have it read
11 back. I don't remember exactly what I said --

12 Q. Okay.

13 A. -- in response to which particular
14 question right now.

15 Q. Well, let me pose a new question,
16 sir, and I think I have asked you this before,
17 and I am going to pose it again because I am
18 unclear now.

19 You have communicated with third
20 parties with regard to IViewIt; is that
21 correct?

22 A. Well, what do you mean by "third
23 parties"?

24 Q. People or entities other than
25 IViewIt.

75

1 Rubenstein

2 A. Uh -- I might have, I might not
3 have, I am not sure right now.

4 Q. And those third parties you are
5 saying are clients of yours, is that why you
6 are asserting a privilege?

7 A. Well, it depends who you mean by a
8 "third party". You know, "third party" is a
9 vague term.

10 Why don't you name some particular
11 third parties and I will answer the question,
12 if I have haven't answered it already.

13 Q. I think you said that you were
14 asserting a privilege with regard to Warner
15 Bros., I think you said --

16 A. Well, Warner Bros. is a client
17 here.

18 Q. Right. And Sony.

19 A. Sony is a client here.

20 Q. Right. So you refuse to answer



Lorraine Christine Hoffman, Esq.
Assistant Staff Counsel
The Florida Bar
File No. 2003-51, 109(15C)

21 whether or not you had communicated to those
22 parties with regard to IViewIt; is that
23 correct?

24 A. Correct, or anything else I might
25 have communicated to them.

76

1 Rubenstein

2 Q. Well, I am not asking you about
3 anything else, because, really, frankly, sir,
4 that's not only not relevant but, clearly,
5 that would be privileged, but I am asking you
6 with regard to simply IViewIt --

7 A. Well, you know, that's our
8 position, our position is that any
9 conversation with those entities is
10 privileged.

11 Q. Okay, and if there was a
12 discussion -- are you saying there was no
13 discussion or are you saying there was a
14 discussion that was privileged?

15 A. I am not saying there was a
16 discussion, I am not saying there was not a
17 discussion, I am saying it's privileged.

18 Q. So you can't simply answer no,
19 there was no discussion --

20 A. I am not saying there was, I am
21 not saying there was not, I am saying it's
22 privileged.

23  MR. SELZ: I am going to certify
24 that question, we will take it up with
25 Judge Labarga and see what his

77

1 Rubenstein

2 determination is about that.

3 (RULING SOUGHT.)

We cite the following as evidence in direct contradiction that Rubenstein was not an advisor to Iviewit and that he had full knowledge of such relationship and thus constitutes



Lorraine Christine Hoffman, Esq.
Assistant Staff Counsel
The Florida Bar
File No. 2003-51, 109(15C)

further perjured deposition testimony, this page from an I View It business plan was found in the files of Proskauer Rose with what appears to be Mr. Wheeler hand writing to illustrate his thorough review of Mr. Rubenstein as patent counsel for Iviewit and an advisor.



Lorraine Christine Hoffman, Esq.
Assistant Staff Counsel
The Florida Bar
File No. 2003-51, 109(15C)

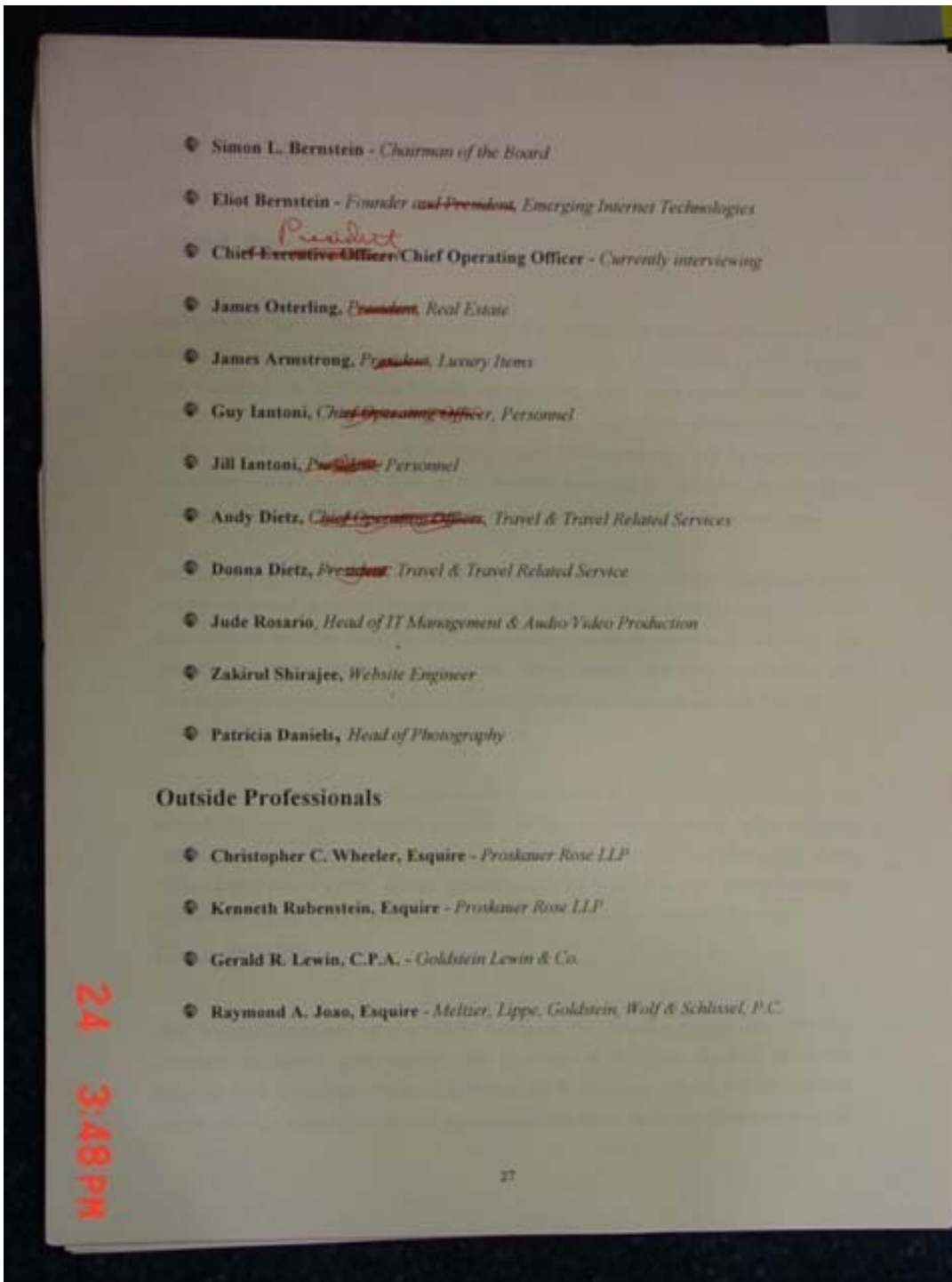



Lorraine Christine Hoffman, Esq.
Assistant Staff Counsel
The Florida Bar
File No. 2003-51, 109(15C)

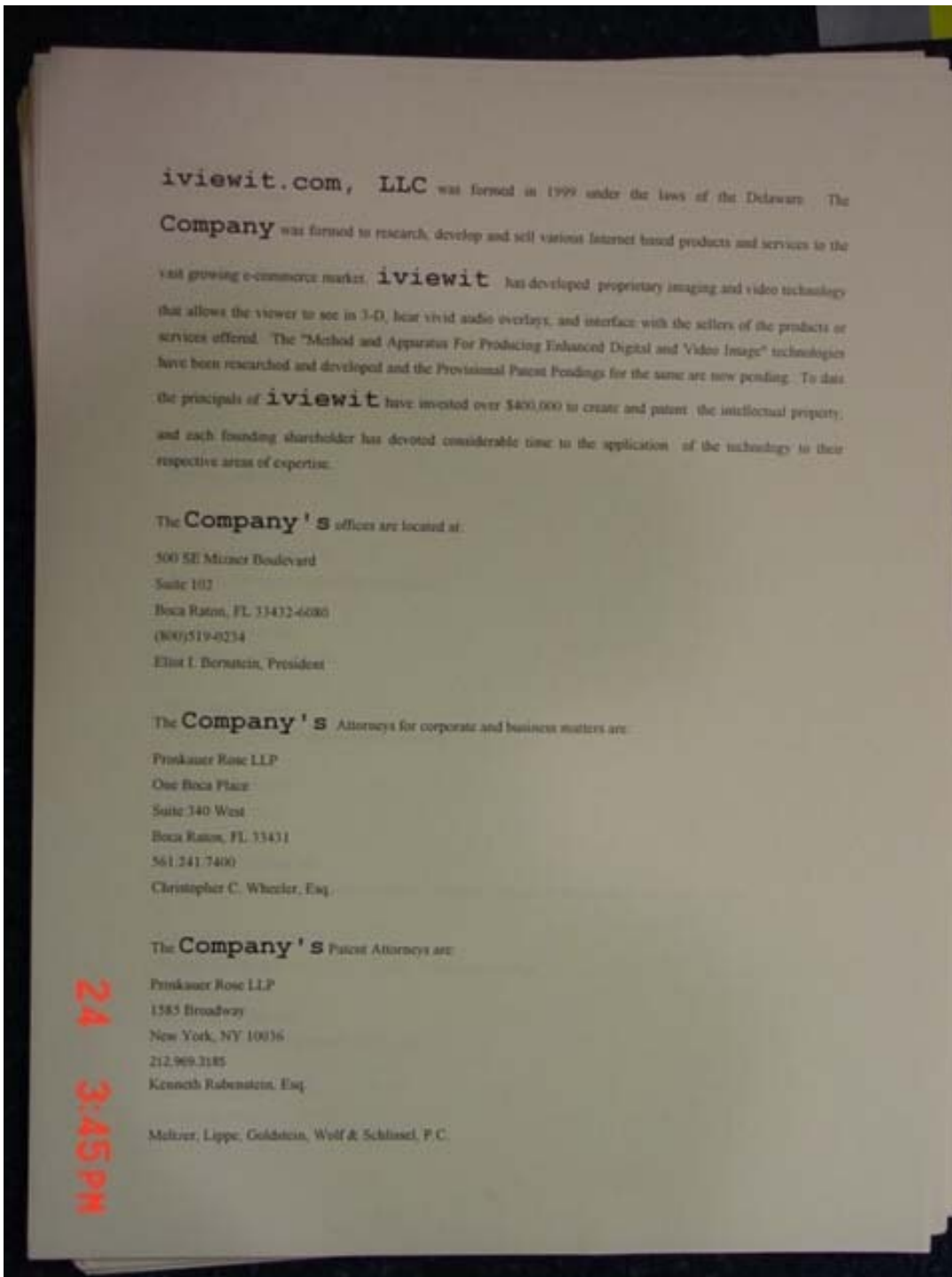



Lorraine Christine Hoffman, Esq.
Assistant Staff Counsel
The Florida Bar
File No. 2003-51, 109(15C)

We also submit from the Wachovia Private Placement the following quips on Mr. Rubenstein and his capacity in the Company, remember this plan was authored and approved by both Christopher Wheeler on behalf of Proskauer Rose and billed for and disseminated by his offices. Mr. Brian Utley is the author for the Company in direct contradiction to his claims that he never used Rubenstein as an advisor. Mr. Utley and Mr. Wheeler distributed the plans to approximately 50 investment firms, countless potential clients and all shareholders and investors in Iviewit. We will provide several business plans authored by various consultants in their entirety as well the Wachovia Private Placement, we quote here from the Wachovia plan:



Lorraine Christine Hoffman, Esq.
Assistant Staff Counsel
The Florida Bar
File No. 2003-51, 109(15C)

Confidential Private Placement Memorandum Number: V19

Offeree: _____

CONFIDENTIAL PRIVATE PLACEMENT MEMORANDUM



\$12 MILLION PREFERRED STOCK

December 2000

WACHOVIA SECURITIES, INC.

WACHOVIA



Lorraine Christine Hoffman, Esq.
 Assistant Staff Counsel
 The Florida Bar
 File No. 2003-51, 109(15C)



CONFIDENTIAL

I. EXECUTIVE SUMMARY

Transaction Overview

Wachovia Securities, Inc. ("WSI") has been engaged by iviewit Holdings, Inc. ("iviewit" or the "Company") as its exclusive agent to assist the Company in raising up to \$12 million in preferred equity capital to become a leading end-to-end solutions provider of video and imaging products for delivery over the Internet. The Company is a developer and provider of proprietary, leading-edge visual and audio enabling, processing technologies supporting rich media streaming and imaging over the Internet. The Company can process and encode (digitize and compress) virtually all types of audio and video media into a variety of Internet-enabled formats while also optimizing the content for distribution across a variety of bandwidths. Using its technology, iviewit can provide multimedia solutions for Internet and CD-based applications. Also, iviewit can store, host, and distribute media content at its data centers or through multiple hosting partners.

iviewit is the leadership company providing video streaming technologies that deliver a rich video experience with virtually distortion-free, full screen capability at normal, TV-equivalent frame rates of 29.97 fps (frames per second) and providing imaging technologies that deliver rich images over the Internet. Similarly, iviewit is the first and only company to provide virtual imaging that preserves and delivers full image quality and detail of the original image - without distortion - not only during compression (up to 100:1), but also through high resolution zooming and panning.

The Company's revenue model is based primarily on encoding, serving, and licensing revenues. The Company commercialized its products in May 2000. Within a short period of time, iviewit has secured 17 customers - primarily in the entertainment, advertising, and hotel markets and many are high profile industry customers. The Company expects to realize approximately \$400,000 in revenue by year-end from these customers.

The Company has developed and launched the following three breakthrough video/audio streaming and image enhancement technologies that enable:

1. **full-screen, full-frame rate video** (including CD quality audio) at 150-300 Kbps, and at lesser bandwidths, a markedly improved video quality over current industry standards, as depicted below:

<u>Bandwidth Range</u>	<u>iviewit Frame Rate</u>	<u>Industry Typical Frame Rate</u>
28-56 Kbps	8-15 frames/sec.	4-8 frames/sec.
56-150 Kbps	15-30 fps	12-20 fps
150-300 Kbps	30 fps	12-24 fps

2. **full-screen, high definition pictures** that have "scan, pan and zoom, and virtual tour" capabilities at all bandwidths
3. **high fidelity, audio streams** at bandwidths as low as 56 Kbps and mono streams at bandwidths as low as 28.8 Kbps.

iviewit, located in Boca Raton, Florida, was formed in 1999 under the laws of the state of Delaware. Over the past year, iviewit has confirmed the efficacy and reliability of its technologies, initiated digital imaging production, established a demonstration website, developed an initial key management infrastructure, and hired an initial sales and production staff.

The Company continues to pursue an aggressive intellectual property strategy. iviewit has protected its enabling technologies by filing 6 patent pending applications in both the United States and abroad for its video streaming and imaging capabilities, covering a wide array of enabling technologies. The Company also has two remaining provisional patent pending applications that will be converted to patent pending status within the allowable period. The



Lorraine Christine Hoffman, Esq.
 Assistant Staff Counsel
 The Florida Bar
 File No. 2003-51, 109(15C)



CONFIDENTIAL



Company has retained Foley & Lardner to shepherd its patent development and procurement. In addition, the Company has retained Kenneth Rubenstein of Proskauer Rose, LLP to oversee its entire patent portfolio – Mr. Rubenstein is the head of the MPEG-2 patent pool.

iviewit has assembled a complementary and seasoned, management team with executive rank, Fortune 100 and early-stage, entrepreneurial experience. The Company has retained Korn / Ferry to assist in the identification and recruitment of a high impact Chief Executive Officer (preferably from the media or entertainment industry) and an experienced Chief Technical Officer.

Since its June 1999 inception, the Company has raised over \$4.3 million of venture capital from Crossbow Ventures, Huizenga Holdings, and individual investors.

Technology Overview

iviewit's suite of video and imaging technology processes work across all industry platforms.

Imaging:

iviewit's imaging process is an enabling technology that creates an unparalleled, content-rich, viewing experience. Significant advantages of iviewit's imaging process include the following:

- Photo-quality Internet images
- Resistance to pixelation even at 30+:1 magnification (note: depending upon the material and the desired magnification)
- Full-screen and panoramic viewing up to 360°
- Consistent quality regardless of the end-user's Internet connection
- File sizes of 30Kb to 700 Kb for full panorama

Video:

The Company's video technologies allow high quality video streaming in the 150-300 Kbps range, providing better product and price performance for the product delivered and a significantly improved results in the 28-150 Kbps range. Below is a chart comparing iviewit's video capability to current industry levels:

<u>Bandwidth Range</u>	<u>iviewit Frame Rate</u>	<u>Industry Typical Frame Rate</u>
28-56 Kbps	8-15 frames/sec.	4-8 frames/sec.
56-150 Kbps	15-30 fps	12-20 fps
150-300 Kbps	30 fps	12-24 fps

The iviewit video technology is a highly scalable process costing approximately \$1.50/min of encoded video. The resulting files are ~25% less than comparable quality files. iviewit's 220Kps streams are equivalent to competition 300Kbps streams.

Business Strategy

iviewit intends to serve as an end-to-end applications solutions provider incorporating iviewit's proprietary imaging and or video technologies as well as a full-service image and video encoding, hosting and serving provider. iviewit licenses its imaging solutions to B2B and B2C clients in the auction, collectibles, and retail space with subsequent marketing into the healthcare and medical markets. iviewit is also structuring OEM and re-seller relationships to bundle the imaging software and processes with existing hardware including: digital cameras, scanners, and PCs. iviewit is structuring video license agreements with major content and broadband access providers to incorporate the iviewit process into video encoding solutions for direct internet streaming.

iviewit technologies are "process technologies" with pending patents based on efficiency equations, and many of the applications for these technologies are just now being recognized.



Lorraine Christine Hoffman, Esq.
 Assistant Staff Counsel
 The Florida Bar
 File No. 2003-51, 109(15C)



CONFIDENTIAL

II. INVESTMENT HIGHLIGHTS

- ◆ ***Unique processing technologies for video and imaging***

iviewit's patent pending processing technologies can create high-definition images with "scan, pan, and zoom" capabilities, high-fidelity audio streams, and full-screen, full-frame rate video for streaming over the Internet. The iviewit video technology is a highly scalable process. The resulting files are approximately 25% less than comparable quality files. iviewit 220Kps streams are equivalent to competitive 300Kbps streams. The Company's imaging process delivers images that are photo-quality, resistant to pixelation even at magnification levels of 30+:1. Images produced by iviewit's proprietary process are identical in quality regardless of the end-user's Internet connection speed. File size options are tailored to minimize download times and optimize the end-user's experience.

- ◆ ***Complementary and Seasoned Fortune 100 and Entrepreneurial Management Team***

iviewit has assembled a complementary and seasoned management team with Fortune 100 and early-stage, entrepreneurial experience. Management consists of former IBM operations executives who have experience in building video delivery capabilities and of marketing talent from successful venture-backed technology companies. The Company recognizes its strength in operations and product development and recognizes the need to attract a capable, experienced CEO and CTO to accelerate the Company's development. iviewit has retained Korn / Ferry to assist in the identification and recruitment of this talent.

- ◆ ***Strong and Experienced Board of Directors and Advisory Board***

iviewit's Board of Directors and Advisors consist of several well-established individuals from the technology, entertainment, and financial community. Directors have extensive backgrounds with top-tier firms such as Goldman Sachs, Kidder Peabody, and McKinsey & Co. Crossbow Ventures has provided \$3.0 million in funding and sits on the Board. Technology and entertainment guidance comes from a partner at Armstrong Hirsch Jackoway & Wertheimer and from Kenneth Rubenstein, the head of the MPEG-2 patent pool.

- ◆ ***Significant Intellectual Property Position and Strategy***

iviewit has protected its enabling technologies by filing 6 patent pending applications in both the United States and abroad for its video streaming and imaging capabilities, covering a wide array of enabling technologies. The Company also has two remaining provisional patent pending applications that will be converted to patent pending status within the allowable period. The Company has retained Foley & Lardner to shepherd its patent development and procurement. In addition, the Company has retained Kenneth Rubenstein of Proskauer Rose, LLP to oversee its entire patent portfolio. The Company's strategy is to establish market precedence through licensing of trade secrets and know-how.

- ◆ ***Substantial Market Penetration and Growing Customer Acceptance***

The Company commercialized its products in May 2000. In just 5 months, iviewit has experienced a 75% success rate in obtaining service and licensing customers, securing 17 customers to date – primarily in the entertainment, advertising, and hotel markets. The Company expects to realize approximately \$400,000 in revenues by year-end from these customers. High profile customers include Ellen DeGeneres, Z.com (Alanis Morissette), Hyatt Hotels, Gear Magazine, and Hollywood.com. Highly probable for closing by year-end 2000 include Warner Brothers and Greg Manning Collectibles.

- ◆ ***Focused on Media Rich Target Markets – Unlocking the Value of Content***

The Company's business strategy is to first target high-profile content owners and distributors as clients to process video and images and to brand those images with iviewit's logo. Secondly, iviewit plans to co-brand with famous celebrities and



Lorraine Christine Hoffman, Esq.
 Assistant Staff Counsel
 The Florida Bar
 File No. 2003-51, 109(15C)

And further from that certain Private Placement Memorandum:



CONFIDENTIAL

Investment Management, both based in London. Among his primary areas of expertise are technology research and economic research, including electronics, telecommunications and computer software. Most recently, he was Senior Technology Analyst and Vice President of Southeast Research Partners, Inc. where he worked with leading technology companies. He earned a bachelor of arts degree at Yale University and a master of business administration degree at Stanford University.

Advisors

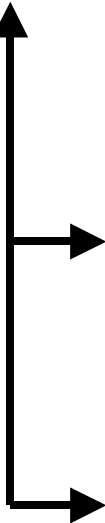

Alan J. Epstein
Partner, Armstrong Hirsch Jackoway Tyerman & Wertheimer, P.C.
 Mr. Epstein's law practice consists of advising Internet companies on various issues pertaining to the entertainment and sports industries, including the creation, licensing and acquisition of content, the introduction and negotiation of strategic partner relationships, and various other matters relating to the convergence of technology and content. Mr. Epstein also advises his firm's numerous celebrity clients on the exploitation and protection of their name and likeness rights and content on the Internet, as well as merchandising, endorsement and sponsorship deals. Prior to entering the UCLA School of Law, Mr. Epstein was a certified public accountant at Deloitte Haskins & Sells in Dallas, Texas.

Kenneth Rubenstein
Partner, Proskauer Rose LLP
 Mr. Rubenstein is a partner at Proskauer Rose LLP law firm and is the patent attorney for iViewit. He is a registered patent attorney before the U.S. Patent & Trademark Office. Mr. Rubenstein counsels his clients with respect to the validity and infringement of competitors' patents, as well as prosecutes patent applications. For the past several years he has worked on the formation of a patent pool, for MPEG-2 technology, involving large consumer electronics and entertainment companies. He is also a former member of the legal staff at Bell Laboratories. Mr. Rubenstein received his law degree, cum laude, from New York Law School, and his Ph.D. in physics from the Massachusetts Institute of Technology where he also graduated with a B.S. Degree.

Christopher C. Wheeler
Partner, Proskauer Rose LLP
 Mr. Wheeler is a member of Proskauer Rose LLP's Corporate Department and as a partner in the Florida office has a versatile transactional practice. He has had extensive experience in real estate and corporate law, institutional lending and workouts, administrative law and industrial revenue bond financing. Moreover, he serves as a strategist and counselor to many clients in handling their other legal and business matters. Mr. Wheeler is well-versed in general corporate law as well as mergers and acquisitions and securities matters. He has guided companies from startup through initial private placements to public offerings. A graduate of Hamilton College and Cornell Law School, Mr. Wheeler was a member of the managing Board of Editor of the Cornell Law Review.

Legal & Accounting Counsel

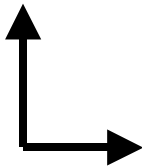

Arthur Andersen, LLP
 Arthur Andersen's vision is to be the partner for success in the New Economy. The firm helps clients find new ways to create, manage and measure value in the rapidly changing global economy. With world-class skills in assurance, tax, consulting and corporate finance, Arthur Andersen has more than 70,000 people in 83 countries that are united by a single worldwide operating structure that fosters inventiveness, knowledge sharing and a focus on client success. Since its beginning in 1913, Arthur Andersen has realized 86 years of uninterrupted growth, with 1999 revenues over \$7 billion. Arthur Andersen is a business unit of Andersen Worldwide.

Proskauer Rose, LLP
 This law firm is one of the nation's largest law firms, providing a wide variety of legal services to major corporations and other clients through the United States and around the



Lorraine Christine Hoffman, Esq.
Assistant Staff Counsel
The Florida Bar
File No. 2003-51, 109(15C)



CONFIDENTIAL

world. Founded in 1875 in New York City, the firm employs 475 attorneys and has wide experience in all areas of practice important to businesses, including corporate finance, mergers and acquisitions, real estate transactions, bankruptcy and reorganizations, taxation, litigation and dispute resolution, intellectual property, and labor and employment law.

Armstrong Hirsch Jackoway Tyerman & Wertheimer, P.C.

One of the nation's leading entertainment law firms. Based in Los Angeles, California, it represents many of the most prominent actors, writers, directors and producers of feature films, television programming and other entertainment content. The firm also represents various content and technology companies in the Internet industry, including prominent web sites, entertainment-oriented portals, aggregated celebrity sites and various e-commerce companies. The firm is assisting in developing the business structure and strategic relationships for iviewit.

Foley & Lardner

One of the oldest and largest law firms in America. Founded in 1842, the firm now has more than 750 attorneys in 14 offices, following the February 1996 merger with Weissburg and Aronson, Inc. Foley & Lardner's over 100 highly skilled intellectual property attorneys constitute one of the largest and most sophisticated technology groups in a general-practice law firm in the United States. As one of the few large national law firms with a global intellectual property law group, it is uniquely positioned to help iviewit capitalize on its foreign filings. The firm's broad-based representations in litigation, regulatory affairs and general business counseling is complemented by one of the world's most highly trained staffs, which includes 65 engineering and advanced technical degrees, including 12 Ph.D.'s. The list of clients using Foley & Lardner to fill their intellectual property legal needs ranges from small entrepreneurial start-up companies to large international and multinational corporations. Foley & Lardner attorneys provide solutions and successfully serve the needs of clients around the world, including those situated in the United States, Canada, Latin America, the European Union, Eastern Europe, the Middle East, and the Pacific Rim.

- **William J. Dick** - Special Counsel to the West Palm Beach office of Foley & Lardner. A member of the firm's Intellectual Property Department (Electronics Practice Group), Mr. Dick currently focuses on mentoring other members of the Electronics and Consumer Products Practice Groups in various IP related matters. He also conducts weekly classes in patent related matters for new associates. Mr. Dick joined Foley & Lardner after 26 years with IBM. He began as a patent attorney, and has handled all phases of patent, trademark and copyright duties, including litigation. Mr. Dick's most recent position with IBM was as Assistant General Counsel to IBM Asia Pacific. Mr. Dick is a graduate of the University of Virginia (B.M.E., 1956; L.L.B., 1962 changed to J.D., 1970)
- **Douglas Boehm** - a partner in the Milwaukee office of Foley & Lardner and a member of the firm's Intellectual Property Department (Consumer & Industrial Products Practice Group and Health Information Technology Practice Group), Mr. Boehm practices in the areas of patent, trademark, copyright, and trade secret counseling; U.S. and foreign patent prosecution; and computer software and intellectual property licensing and technology transfers. Mr. Boehm's technical focus encompasses electrical and electronic engineering, including analog/digital/RF circuitry, radio telecommunications, lasers and fiber optics, and computer hardware and software. He has extensive experience in private industry, having worked as a development engineer and patent agent for Motorola, and as patent counsel for a subsidiary of Amoco Technology Company.



Lorraine Christine Hoffman, Esq.
Assistant Staff Counsel
The Florida Bar
File No. 2003-51, 109(15C)

And we submit from Mr. Wheeler's deposition testimony under oath the following statement:



Lorraine Christine Hoffman, Esq.
Assistant Staff Counsel
The Florida Bar
File No. 2003-51, 109(15C)

207

1 business plan that was produced or that you were
2 involved with, did it contain representations
3 concerning intellectual properties?

4 A. We weren't intimately involved in the
5 business plan, so I really don't recall the latest
6 reiteration. No.

7 Q. Do you know if Ken Rubenstein was ever
8 listed as an advisor to the board of directors or an
9 advisor to iviewit in any documents?

10 MR. TRIGGS: Object to the form. By whom?

11 Q. (By Mr. Selz) Do you know if Ken
12 Rubenstein was listed --

13 A. In any documents?

14 Q. -- by iviewit or - in any documents that
15 were submitted to any third parties as an advisor or
16 was represented as an advisor to the board?

17 A. Not - not that I'm aware of.

18 Q. What was the last business plan for
19 iviewit that you can recall seeing?

20 A. Well, I don't recall. I don't -- I
21 actually don't recall the last business plan. I mean,
22 the reason is, everything kept on changing so much.

23 Q. Was there ever any problem with
24 erroneously issued stock or anything of that nature
25 that you're familiar with?

KEN SCHANZER & ASSOCIATES, INC. (954) 922-2660



Lorraine Christine Hoffman, Esq.
Assistant Staff Counsel
The Florida Bar
File No. 2003-51, 109(15C)

Quite to the contrary of Mr. Wheeler's deposition statement where he is unclear if this plan was disseminated it was distributed to amongst others, referrals from Wachovia Securities John D. Deering, Senior Vice President Investment Banking, who we will evidence sent over 20 copies out to members of, including but not limited to:

Adobe Products
Cox Communications Inc., - Mr. Deering's close personal friend, Dallas S. Clement, Senior Vice President Strategy and Development
Audax Management Company LLC
AOLTW
Warner Bros.
Goldman Sachs

We submit to the Florida Bar in direct contrast to Mr. Wheeler's claims that he did not review the business plans the following sampling of Proskauer Rose billings for such reviews and we urge the Florida Bar to review the entire bill, of which much is still missing, for a complete accounting of how many billings were for business plan reviews:



Lorraine Christine Hoffman, Esq.
Assistant Staff Counsel
The Florida Bar
File No. 2003-51, 109(15C)

01/06/99 C WHEELER	1.50	Review of prospectus; conf as to nature of work
01/26/99 G GOLDMAN	1.00	Reviewing IVIEWIT's business plan for patentability opinion; conducting an on-line Internet search.
04/14/99 C WHEELER	.50	Receipt of business plan; begin review of same
04/15/99 G COLEMAN	1.75	Study and review the current form of business plan. Preparation of summary memo re: comments.
04/29/99 K HEALY	.50	Draft Authorization and Release; review Business Plan
04/30/99 K HEALY	.50	Review Iviewit Business Plan
08/09/99 C WHEELER	1.50	Review of business plan
08/11/99 D THOMPSON II	.75	Conference with Attorney C. Wheeler re Business Plan; prepare disclaimers re same.
08/11/99 C WHEELER	2.00	Conf with Mr. Bernstein; conf with Mr. Utley; call to Mr. Epstein; brief conf with Mr. Epstein; conf with Mara Lerner re subscription agreements; call to Mr. Henninger re meeting and business plan;
08/11/99 C WHEELER	.25	Conf with Mr. Utley re business plan and Real 3D
08/11/99 C WHEELER	2.50	Review of business plan; conf with Mr. Utley; conf with Mr. Bernstein re changes
08/11/99 M ROBBINS	3.00	Research Delaware corporate statutes re: merger and voting rights. Review received note subscription agreements. Preparation of promissory notes for execution and mailing. Inter-office conferences with Zamas re: preparation of notes and documentary stamps. Preparation of correspondence to E. Bernstein. Inter-office conferences with Zamas re: issuance of promissory notes. Review files re: business plan legend. Revisions to correspondence to E. Bernstein. Inter-office conference with Thompson re: merger and voting rights. Inter-office conferences with Wheeler re: business plan review and intellectual property matters.
08/13/99 C WHEELER	2.00	Arrange transmittal of various business plans; preparation of correspondence re same; message from Mr. Henninger
09/30/99 C WHEELER	3.00	Conference w/Brian Utley; conference with Mr. Bernstein; review of status re confidentiality agreement; conference as to transfer of patent information, business plans



Lorraine Christine Hoffman, Esq.
Assistant Staff Counsel
The Florida Bar
File No. 2003-51, 109(15C)

12/10/99 D THOMPSON II .25 Conference with Attorney Gayle Coleman re private placement memorandum.

12/14/99 G COLEMAN 5.00 Conference with Guy Iantoni and M. Robbins re: agreement for photo/videographer (independent contractor). Study and review form of LLC Agreement. Preparation of form private offering memorandum.

12/14/99 M ROBBINS 4.75 Review document forwarded to E. Lewin re: noteholders for reconciliation. Meeting with G. Iantoni and G. Coleman. Inter-office conferences with Gayle Coleman re: independent contractor agreement for photographer/videographer. Revisions to License Agreement. Draft and preparation of Jenex termination letter. Telephone conferences with J. Lewin re: transfer of shares to David Bernstein, assignment of notes from iviewit.com to uview. Telephone conferences with NY library re: Dan Socolof. Telephone conferences with E. Bernstein re: Dan Socolof. Preparation

of e-mails re: independent contractor agreements. Review S-B Rules re: officer and

Missing rest of sentence and rest of page blank on next page also next page is not numbered although text appears on it



Lorraine Christine Hoffman, Esq.
Assistant Staff Counsel
The Florida Bar
File No. 2003-51, 109(15C)

director questionnaires and general securities issues relative to PPM. Telephone call to S. Bernstein. Preparation of e-mail to Gayle Coleman re: control persons. Preparation of private offering memorandum.

01/10/00 M ROBBINS 8.50 Multiple inter-office conferences with Gayle Coleman re: name changes and corresponding documentation. Telephone conference with Brian Utley re: D&O Questionnaire. Meeting with Jerry Lewin re: completion of D&O

01/10/00 A LEVY 1.00 Work on bio for PPM; review documents re name changes.

01/14/00 M ROBBINS 6.25 Telephone conference with Rodney Bell re: due diligence materials. Meetings with E. Lewin re: additional due diligence items. Telephone conferences with Maurice Buchsbaum and Eliot Bernstein re: business plan. Inter-office conference with Gayle Coleman re: private offering memorandum, revisions to offering memorandum re: risk factors for potential infringement and business plan. Review annotated due diligence list and conferences

with Jill Zammass re: same. Revisions to stockholder lists of iviewit entities. Preparation of memorandum to corporate department re: iviewit structure and organizational charts. Meeting with Erika Lewin re: business plan and audited financials. Preparation of e-mail to Gayle Coleman re: business plan and financials. Draft and preparation of correspondence to Rodney Bell. Preparation of e-mail to Jill Zammass re: due diligence request list documents. Inter-office conferences with Rocky Thompson re: dissolution of iviewit LLC, acknowledgment agreement to employment agreement for stock splits, Investech share exchange, minority shareholder exchange option.



Lorraine Christine Hoffman, Esq.
Assistant Staff Counsel
The Florida Bar
File No. 2003-51, 109(15C)

- 01/14/00 G COLEMAN 3.25 Telephone conference with Martha re: private offering memorandum. Telephone conference with E. Lewin re: audited financial statements. Inter-office conference with R. Thompson re: private offering memorandum and information to be included. Preparation of revisions to intellectual property risk factors. Inter-office conference with C. Wheeler re: potential intellectual property infringement. Multiple inter-office conferences with M. Robbins re: due diligence, private placement and infringement issues. Preparation of chart for corporate restructure. Multiple inter-office conferences re: business plan.
- 01/17/00 M ROBBINS 6.50 Inter-office conferences with Gayle Coleman re: business plan. Inter-office conferences with Jill Zamas re: forwarding additional due diligence documents to Rodney Bell, revisions to list of due diligence documents and circulation of memo to corporate department and iviewit re: due diligence documents forwarded to Rodney Bell. Review and revise due diligence documents list. Review iviewit LLC Agreement re: dissolution. Inter-office conferences with Gayle Coleman re: financials for offering memorandum. Telephone conferences with Spencer Romoff re: tax matters relative to share exchange option agreement. Review and preparation of comments to business plan. Review and revise organizational lists.
- 01/17/00 G COLEMAN 7.75 Inter-office conference with R. Thompson re: financial disclosure issues. Inter-office conference with R. Thompson re: risk factors related to intellectual property. Multiple-inter-office conferences with M. Robbins re: corporate structure and business plan modifications. Conference with E. Lewin re: financial information. Telephone conference with K. Rubinstein re: possible infringement. Review and comment on proposed form of Business Plan. Study and revise form of warrant certificate for Emerald Partners.
- 01/18/00 M ROBBINS .25 Telephone conference with G. Coleman re: business plan.
- 01/18/00 G COLEMAN 5.00 Preparation of revisions to form of Warrant for Emerald Partners. Inter-office conference with A. Levy re: same. Preparation of revisions to risk factors relating to intellectual property and to private offering memorandum. Preparation of revisions to business plan.



Lorraine Christine Hoffman, Esq.
Assistant Staff Counsel
The Florida Bar
File No. 2003-51, 109(15C)

02/01/00 C WHEELER 1.00 Conference w/B.Utley; conference w/M.Robbins;
conference w/R.Thompson; arrange for follow up
re business plan

02/01/00 M ROBBINS 8.00 Inter-office conferences with A. Levy re:
furniture documentation. Preparation of binder
for Cris Branden. Inter-office conferences
with Jill Zammass re: issuance of stock
certificates to Investech and iviewit Holdings.
Meeting with Buchsbaum re: capitalization.
Multiple telephone conferences with George
Villasana re: due diligence. Inter-office
conferences with Jill Zammass re: capitalization
charts. Inter-office conferences with Rocky
Thompson re: replacement stock certificates.
Inter-office conferences with Jill Zammass re:
form letter to stockholders regarding name
change. Multiple telephone conferences with
Erika Lewin re: balance sheets and accrual of
compensation. Telephone conference with Chris
Wheeler re: insert to business plan. Draft and
preparation of insert to business plan re:
corporate structure. Legal research re: notice
of written action and inter-office conference
with Rocky Thompson re: same. Inter-office
conferences with Rocky Thompson re:
corresponding issuance of shares to subsidiary.
Preparation of correspondence to Cris Branden.
Telephone call to Spencer Romoff re: tax issues
for corresponding issuances. Calculation of
shares for Alpine transaction. Inter-office
conferences with Rocky Thompson re: Alpine
share issuance and term sheet.

02/01/00 G COLEMAN 3.25 Modify business plan insert. Inter-office
conference re: furniture documentation.
Preparation of Intercompany assignment of IP.
Inter-office conference re: accredited investor
issues. Calculations re: Alpine. Telephone
conferences with E. Lewin re: balance sheet
information. Inter-office conferences re:
stockholder and share issuances.

06/04/00 I LEVIN .50 Review plan.

08/17/00 C WHEELER 1.00 Conf with Mr. Utley as to financing; review of
business plan materials; conf as to Soros group

09/05/00 C WHEELER .50 Conf with Mr. Utley; review of Wachovia letter

12/01/00 C WHEELER .50 Conf with Mr. Hersh; arrange transmittal of
business plan to prospective investors

01/15/01 G COLEMAN .75 Review business plan. Inter-office conferences
with M. Robbins. Inter-office conference with
R. Thompson.



Lorraine Christine Hoffman, Esq.
Assistant Staff Counsel
The Florida Bar
File No. 2003-51, 109(15C)

As malfeasances started to unfold regarding Utley and his background and his misstatements in the plan, Utley unilaterally began to change the Wachovia plan in meetings to a distance learning sexual harassment presentation and at a meeting attended by Mr. Deering at Cox Communications, Mr. Deering became visibly upset with Mr. Utley for changing the Company from a technology company and asked until matters were further resolved that Iviewit distribute no more Wachovia plans. This led to the end of the Wachovia business arrangement putting Iviewit in even more peril caused by Utley/Wheeler. As the allegations regarding the malfeasances began surfacing and then began to get validated Wachovia pulled out of their relationship with the Company, especially when they found that statements regarding Mr. Utley's past were misrepresented to them as well patents malfeasances.

We submit the following confirmation evidence to refute Mr. Wheeler's testimony that he did not think the plan, he billed for, co-authored, disseminated, had ever been distributed:

And we submit as evidence the following business plan completed by a consultant for Iviewit, you can see that it has been sent to Christopher Wheeler and has his review comments added prior to dissemination.

-----Original Message-----

From: Eliot I. Bernstein [mailto:viewmaster@iviewit.com]
Sent: Tuesday, February 01, 2000 8:11 PM
To: James F Armstrong (E-mail); Simon L. Bernstein (E-mail); Donald G. Kane II (E-mail); Jeffrey Friedstein (E-mail); Maurice Buchsbaum (E-mail)
Subject: **FW: Business Plan with Chris Wheeler's Info and Corporate Structure**

DRAFT

-----Original Message-----

From: [Kathv Yeung \[mailto:kathyeung@sroconsultants.com\]](mailto:kathyeung@sroconsultants.com)
Sent: Tuesday, February 01, 2000 6:31 PM
To: alps@netline.net
Subject: **Business Plan with Chris Wheeler's Info and Corporate Structure**

[<<Iviewit Business Plan Version 1.9.doc>>](#)

And the distribution list clearly shows this plan sent to Kenneth Rubenstein and Christopher Wheeler.



Lorraine Christine Hoffman, Esq.
Assistant Staff Counsel
The Florida Bar
File No. 2003-51, 109(15C)

-----Original Message-----

From: EIB [mailto:alps@netline.net]
Sent: Saturday, February 05, 2000 8:58 AM
To: Alan J. Epstein (E-mail); **Christopher C. Wheeler (E-mail)**; Donald G. Kane II (E-mail); Gerald R. Lewin (E-mail); Iantoni (E-mail); James F. Armstrong (E-mail); Jeffrey Friedstein (E-mail); Jeffrey Friedstein (E-mail 3); **Kenneth Rubenstein (E-mail)**; Leo Abbe (E-mail); Maurice Buchsbaum (E-mail); Mitchell Welsch (E-mail); Raymond A. Joao (E-mail); Simon L. Bernstein (E-mail)
Subject: iviewit business plan final draft

This is the final draft of the new business plan that will be ready Monday afternoon. We are waiting for an audit on the financial section from our accountants and then we can begin disseminating to prospective investors. Please send any comments or changes ASAP.

Thanks - Eliot

And from that business plan we provided the following evidence to support the claim that Rubenstein was an approved Advisor by Wheeler and these plans were also sent to Mr. Rubenstein for his approval. This plan as the front page illustrates was managed and distributed by Mr. Brian G. Utley, Mr. Wheeler's best friend.



Lorraine Christine Hoffman, Esq.
Assistant Staff Counsel
The Florida Bar
File No. 2003-51, 109(15C)



*A Leader in New Visual Technologies for Tomorrow's
Markets*

Business Plan

Contact Information:

→ **Brian G. Utley, President & COO**

iviewit.com

One Boca Place

2255 Glades Road, Suite 337W

Boca Raton, Florida 33431

561-999-8899 ext. 304

brian@iviewit.com



Lorraine Christine Hoffman, Esq.
Assistant Staff Counsel
The Florida Bar
File No. 2003-51, 109(15C)

Attachment B – iviewit.com’s Advisory Board, Legal Counsel and Consultants

Advisory Board

- **Don G. Kane** - Don Kane is President of GDI, a privately held holding company that controls 4 business-to-business Internet companies. Prior to joining GDI, Don was a Managing Director in the Investment Banking Division of Goldman Sachs & Co. During his fourteen-year career at Goldman Sachs, Don created the firm’s Midwest Financial Institutions practice and founded a Global Financial Institutions Technology Group. Don is a Board member and Vice Chairman of Sagence Systems, Inc., a GDI company and is a member of the Board of Versifi, Inc. and Erogo Systems. Don is an advisor to Signcast, Inc., Gryphon Holdings and Capita Technologies. He is a member of the Kellogg Graduate School of Management Advisory Board at Northwestern University and is a member of the Board of the Metropolitan YMCA of Chicago.
- **Alan Epstein** – Alan Epstein is a shareholder of the entertainment law firm Armstrong Hirsch Jackoway Tyerman & Wertheimer, P.C., which is based in Los Angeles. Alan’s law practice consists of advising Internet companies on various issues pertaining to the entertainment industry, including the creation, licensing and acquisition of content, the introduction and negotiation of strategic partner relationships, and various other matters relating to the convergence of technology and content. Alan also advises his firm’s numerous celebrity clients on the exploitation and protection of their name and likeness rights and content on the Internet, as well as merchandising, endorsement and sponsorship deals. Prior to entering the UCLA School of Law, Alan was a certified public accountant at Deloitte Haskins & Sells in Dallas, Texas.
- **Chris C. Wheeler** – Chris Wheeler, a member of Proskauer Rose LLP’s Corporate Department and a partner in the Florida office, has a versatile transactional practice. Chris has had extensive experience in real estate and corporate law, institutional lending and workouts, administrative law and industrial revenue bond financing. Moreover, he serves as a strategist and counselor to many clients in handling their other legal and business matters. Chris is well-versed in general corporate law as well as mergers and acquisitions and securities matters. He has guided companies from startup through initial private placements to public offerings. A graduate of Hamilton College and Cornell Law School, Chris was a member of the managing Board of Editor of the Cornell Law Review.



Lorraine Christine Hoffman, Esq.
Assistant Staff Counsel
The Florida Bar
File No. 2003-51, 109(15C)

Hamilton College and Cornell Law School, Chris was a member of the managing Board of Editors of the Cornell Law Review.

- **Kenneth Rubenstein** – Ken is a partner at Proskauer Rose LLP law firm and is the patent attorney for iviewit.com. He is a registered patent attorney before the U.S. Patent & Trademark Office. Ken counsels his clients with respect to the validity and infringement of competitors' patents, as well as prosecutes patent applications. For the past several years Ken has worked on the formation of a patent pool, for MPEG-2 technology, involving large consumer electronics and entertainment companies. Ken is also a former member of the legal staff at Bell Laboratories. Ken received his law degree, cum laude, from New York Law School, and his Ph.D. in physics from the Massachusetts Institute of Technology where he also graduated with a B.S. Degree.

After Mr. Wheeler added his comments to this plan he received the following letter from Alan Epstein of Armstrong Hirsh Jackoway and Wertheimer where the plan was disseminated to their clients which consisted of many of the top studios, including but not limited to WB, Fox, Vivendi, and Disney, all of whom the Company had been working on a digital download of their entire video library's using the scaling techniques and other inventions by Bernstein, Rosario, Friedstein and Shirajee. This letter was also sent to Donald Kane and Jeffrey Friedstein, along with the business plan, members of Goldman Sachs.



Lorraine Christine Hoffman, Esq.
 Assistant Staff Counsel
 The Florida Bar
 File No. 2003-51, 109(15C)

Eliot I. Bernstein

Subject: FW: Iviewit Private Offering

-----Original Message-----

From: [Epstein, Alan \[mailto:Aepstein@AHJTW.com\]](mailto:Aepstein@AHJTW.com) ←
 Sent: Tuesday, January 04, 2000 4:15 PM
 To: 'Don Kane'
 Cc: 'Bernstein, Eliot (Bellsouth)'; 'Bernstein, Eliot (netline)';
 'Bernstein, Simon'; 'Utley, Brian'; ['Wheeler, Chris'; 'Lewin, Gerry';](#)
 Friedstein, Jeff; 'Friedstein, Jeff (MSN)'
 Subject: [Iviewit Private Offering](#) ↑

Don:

We had a two day brainstorming session in LA with several consultants, with the purpose of developing a more professional and comprehensive business plan. The consultants absolutely loved the technology. One guy thinks that the video and imaging technology are worth over \$500M today alone. We had to do a lot of talking to get them down to a \$100M valuation. My guess is that this company is worth a lot (as in billions) or very little. Market acceptance of technology, the strength of the patents and execution of the business plan are some of the key variables.

I'm concerned that raising funds at a \$25M valuation today will make it difficult to go out at a much higher valuation in the next few weeks, which was the plan. (We decided that the company needed \$10M to launch as a licensing [not content] company.) I suggested that we hold off on the interim round, or try to reprice it with a flexible pricing formula. Everyone seems to be saying that we don't have the luxury of choice right now. But I think we'll pay a price (how much I don't know) when we're trying to convince the next round of investors to buy in at a much higher price.

Your skepticism as to the \$100M price may be well founded. I know that it's going to be difficult to get the price up that high, unless we're able to put together a kick ass package and create some competitive bidding pressure. But the \$25M interim round certainly won't help.

I like your idea of selling common stock in the next round at the \$25M valuation. We can then argue that the higher valuation (or at least a portion of it) for the following round is justified due to the preferred or senior nature of the position. By copy of this email, I'm asking Chris, Brian and Gerry to consider this as a possibility. This means that the next round of investors would be buying common stock, without any liquidation or dividend preferences, in the same manner as the founders. (Ordinarily, the investors would want some type of preferred stock.)

Hope you had a great new year!

Regards,

Alan J. Epstein
 aepstein@ahjtw.com
 tel. 310/553-0305
 fax. 310/553-5036

The information contained in this email is confidential. It is intended solely for the addressee. Access to this email by anyone else is

Now with this knowledge the next major machination of the business plan was with Wachovia securities for a \$12-25M raise and Mr. Wheeler was again an author, billed for, and disseminator of such plan that contained both him and Mr. Rubenstein as key



Lorraine Christine Hoffman, Esq.
Assistant Staff Counsel
The Florida Bar
File No. 2003-51, 109(15C)

advisors. In this plan it is apparent that they both are fully cognizant of all the applications the technologies are applied for and we will submit a fully copy of the Wachovia plan as [Exhibit C](#).

As you will see below the plan in January 2001 had been distributed by Wachovia alone to 20 potential investment firms.

-----Original Message-----

From: Eliot I. Bernstein [mailto:eliot@iviewit.com]
Sent: Monday, January 08, 2001 12:53 PM
To: '[John Deering](#)'; Eliot I. Bernstein; Brian G. Utley; Maurice R. Buchsbaum; Joe Lee
Cc: Jeffrey Friedstein (E-mail); Jeffrey Friedstein (E-mail 2)
Subject: RE: iviewit PPM Distribution Update
Importance: High

John, you most certainly may pursue. My connections are at Goldman in Chicago, Sheldon and Jeff Friedstein. I do not know the Pequot people, Maurice does. You are welcome to call Jeff at 800.233.9622. Thanks!

Eliot

-----Original Message-----

From: John Deering [mailto:John.Deering@WachoviaSecurities.com]
Sent: Monday, January 08, 2001 8:28 AM
To: 'Eliot I. Bernstein'; Brian G. Utley; Maurice R. Buchsbaum; Joe Lee; John Deering
Subject: RE: iviewit PPM Distribution Update

Eliot, thanks for the note on Jim Orlando. Two names I've put on hold are Goldman and Pequot b/c I assumed they have already reviewed the opportunity via your connections. Should I pursue these two firms? John



Lorraine Christine Hoffman, Esq.
Assistant Staff Counsel
The Florida Bar
File No. 2003-51, 109(15C)

-----Original Message-----

From: Eliot I. Bernstein [<mailto:eliot@iviewit.com>]
Sent: Friday, January 05, 2001 7:01 PM
To: Brian G. Utley; Maurice R. Buchsbaum; Joe S. Lee (E-mail); John D. Deering (E-mail)
Subject: FW: iviewit PPM Distribution Update

David Colter of Warner Brothers knows Jim Orlando ot of San Jose at Battery Ventres and told Jim to review iviewit's site. Hope this helps.

-----Original Message-----

From: Joe Lee [<mailto:Joe.Lee@WachoviaSecurities.com> <<mailto:Joe.Lee@WachoviaSecurities.com>>]
Sent: Friday, January 05, 2001 4:47 PM
To: 'Brian Utley'; 'Maurice Buchsbaum'
Cc: 'Eliot Bernstein'; 'ray@iviewit.com'; 'hpowell@cb-ventures.com'; John Deering
Subject: iviewit PPM Distribution Update

Gentlemen,

Attached you will find a summary of the PPM distribution. We have contacted

20 investors: 16 have PPMs and 4 have passed.

We will make another round of calls to those with the books beginning Tuesday since Mondays tend to be partner meetings.

Regards,
Joe

<<PPM Distribution Management to Company 01-05-01.xls>>

Joe Lee
Investment Banking
Wachovia Securities, Inc.
(P) 404-240-5023
(F) 404-240-5121
joe.lee@wachoviasecurities.com



Lorraine Christine Hoffman, Esq.
Assistant Staff Counsel
The Florida Bar
File No. 2003-51, 109(15C)

Finally, Mr. Deering attending at a meeting with COX whereby Mr. Utley speaks of a merger with a Distance Learning Company and the Company doing sexual harassment modules for fees, all unbeknownst to Mr. Deering who arranged the meeting that the Company had been transformed with no prior knowledge, submits the following letter. No further Wachovia Business plans were disseminated from this point forward. An investigation into the transfer of assets to a distance learning company is still pending investigation of the remaining Proskauer Rose documents. It appears that part of the Proskauer Rose bill is for an authorized merger of which Proskauer prepared documents for, with no consent from the Board or investors.

We submit:

Page 1 of 1

Brian G. Utley

From: jddeering [jddeering@email.msn.com]
Sent: Monday, April 02, 2001 11:04 PM
To: brian@iviewit.com; eliot@iviewit.com; maurice@iviewit.com
Subject: status

Dear Brian, Eliot, and Maurice; The email we delivered today reflected a shrinking list of potential financial investors. While there are still several strong names being pursued we're obviously at a stage warranting more thoughts on strategy. While I'm curious where Warner stands, I think it makes sense to think more along the lines of pure strategic names. If so, I think there needs to be a more straightforward message as the company needs to choose a path - Is this more of a patent play or building of a business? If it's the patent story, we talk about the locked up markets and we minimize the e-learning focus. If it's the building of a business, then the e learning piece becomes more critical. Look forward to your thoughts. John



Lorraine Christine Hoffman, Esq.
Assistant Staff Counsel
The Florida Bar
File No. 2003-51, 109(15C)

XI. Mr. Rubenstein and Mr. Joao misrepresented by Mr. Wheeler as Proskauer partners and correspondences showing that the Company was in belief that they were initially at Proskauer Rose. It was not until March of 1999 supposedly that a retainer was taken with Meltzer Lippe Goldstein and Schlissel, three or months after Joao and Rubenstein began reviewing the patent processes for Iviewit. According to Mr. Joao MLGS no longer has any files as the originals they claim were sent to Foley and Lardner, who no longer has any files as they sent their originals to BSTZ.

Raymond Joao was initially represented as Ken Rubenstein's underling at Proskauer Rose who would be filing the patents for Ken as Ken was a litigator and his role would be in pursuing litigation against infringers and overseeing the Iviewit portfolio. It is interesting to note that Ken Rubenstein and Raymond Joao both were prior at the firm MLGS at the time of the Iviewit processes being invented and after such inventions were discovered Mr. Rubenstein is transferred. It was not until we questioned Mr. Al Gortz and Christopher Wheeler as to Mr. Rubenstein not being listed on the website nor in the phone directory at Proskauer Rose at the end of January of 1999 months after meeting Mr. Bernstein and learning of his inventions, that Mr. Wheeler claimed they were in transition from MLGS to Proskauer Rose and that we would need to take a retainer with MLGS and pay for their work until Raymond would officially transfer over to PR. This transfer never occurred and Iviewit was stuck retaining two firms PR and MLGS to the dismay of the Board and investors. This was after retaining PR and giving them stock and agreeing that their bill would mainly be paid by future royalties from the patent pools overseen by Rubenstein and PR clients. It is apparent in the Proskauer billings that several months pass before Raymond Joao is mentioned and almost five months before a retainer agreement is signed with Meltzer Lippe Goldstein and Schlissel.

We cite the following evidence that Mr. Rubenstein was not locatable at the firm as late as 1/28/99 and not listed on the corporate website, contrary to deposition testimony, although he was unclear on exactly when he started, it appears in Wheeler response to the Florida Bar that they are now claiming he was with the firm since 6/98. As of 1/28/99 his lookup at Martindale was at either of two firms below and NOT at PR. You will note that his email address is also listed as MLG and not Proskauer Rose. Almost 6 months after his transfer as now claimed in Mr. Wheeler's response to the Florida Bar. It is interesting to note that in Mr. Rubenstein's deposition he is unclear of his transfer dates to Proskauer.



Lorraine Christine Hoffman, Esq.
Assistant Staff Counsel
The Florida Bar
File No. 2003-51, 109(15C)

-----Original Message-----

From: Eliot Bernstein [mailto:alps@netline.net]
Sent: Thursday, January 28, 1999 8:42 PM
To: 'agortz@proskauer.com'
Subject: Ken Rubenstein

AI,
I was unable to locate a contact at your firms website for Ken. I did find the following contacts, is he either one or both listed.

KENNETH RUBENSTEIN
MELTZER LIPPE GOLDSTEIN WOLF & SCHLISSEL PC ←

190 Willis Ave
Mineola, New York 11501-2639
Phone: (516) 747-0300
Fax: (516) 747-0653
krubenstein@mlg.com
Position: Member

New York Law School, New York, NY

Patent, Trademark & Copyright Law
or

KENNETH A. RUBENSTEIN ←
BAER MARKS & UPHAM LLP

805 Third Ave
New York, New York 10022-7513
Phone: (516) 741-5553
Fax: (212) 702-5941
Admitted: New York, 1983 New Jersey, 1983

Education: New York Law School, New York, NY

Areas Of Practice: Patent, Copyright and Trademark Law Trade Secret
Born: 1954



Lorraine Christine Hoffman, Esq.
Assistant Staff Counsel
The Florida Bar
File No. 2003-51, 109(15C)

It is interesting to note that in his deposition Mr. Rubenstein fails to mention his employment at the firm of Baer Marks & Upham LLP in his deposition?

Further confirmations that Mr. Rubenstein was receiving patent process information with Mr. Joao and that the Companies position was that these were reviews by Proskauer Rose attorneys is evidenced in the next correspondence. The Company feels that this next piece of evidence although it helps the case against the attorney's is not a true copy of this correspondence and asks the Florida bar to investigate all parties for their true and accurate copies of this document to verify it's validity. As can already been seen in Mr. Rubenstein's deposition, he cannot recall if he maintains emails or the Company does. Mr. Joao likewise has destroyed much of his record as is exhibited in the 7/31/00 transcript [Exhibit E](#).



Lorraine Christine Hoffman, Esq.
Assistant Staff Counsel
The Florida Bar
File No. 2003-51, 109(15C)

>-----Original Message-----

>From: Eliot Bernstein [mailto:alps@netline.net]
>Sent: Tuesday, February 23, 1999 7:53 AM
>To: Kenneth Rubenstein (E-mail); Christopher C. Wheeler
(E-mail)
>Subject: Please call when you receive this message.
800.519.0234 or
>561.417.8980

>

>

>Ken,

>

>Per our discussion, I have attached the following file =
process.doc.

>

>Eliot

> << File: ATT00027.html >> << File: PROCESS.doc >>

-----Original Message-----

From: Eliot Bernstein [mailto:alps@netline.net]
Sent: Friday, March 05, 1999 6:42 AM
To: Simon L. Bernstein (E-mail)
Subject: FW: Please call when you receive this message.
800.519.0234 or
561.417.8980

from the patent attorney at Proskauer

Eliot:

I got the e-mail. I looked over the materials. You have invented a process which appears to be a processing and/or manufacturing process for providing enhanced video images for use on the World Wide Web. There appears to be no reason why we could not get an application out in a rather short time period to establish patent pending. I'll be out of the office until about 3:00 pm today, but I will call you when I get back.

Ray Joao 516-747-0300 x240

>-----Original Message-----

>From: Eliot Bernstein [SMTP:alps@netline.net]
>Sent: Thursday, March 04, 1999 6:18 PM
>To: Raymond A. Joao
>Subject: FW: Please call when you receive this message.
800.519.0234 or
>561.417.8980



Lorraine Christine Hoffman, Esq.
Assistant Staff Counsel
The Florida Bar
File No. 2003-51, 109(15C)

This letter will also serve to illustrate that Mr. Wheeler and Mr. Rubenstein were aware of video processes far earlier than Mr. Wheeler's claim in his deposition that he was unaware of such video inventions until 6/99, another perjured statement in his deposition was that he did not know of the video until after the 5/99 Real3D meeting. Also of note is that Eliot Bernstein comments to his father that this is from the patent attorneys at Proskauer Rose, not MLGS. In Mr. Joao's response to the NY Bar we find that Joao claims we knew him in 2/99 at MLGS and MLGS has lost their retainer agreement with the Company. Mr. Joao in his statements goes so far as to allege that Iviewit is infringing on his patents, of which he now has **50+** many of them after and during his engagement with Iviewit. His claim to the New York bar that we are infringing on his patents is almost criminal. In fact, how could he even take Iviewit as an account with a COI as major as this, and how could Mr. Rubenstein have referred us to someone who would have had competing patents, let alone as patent counsel.

We submit evidence that as Joao was working with Iviewit his own personal patent portfolio was blooming into areas that conflict with Iviewit.



Lorraine Christine Hoffman, Esq.
Assistant Staff Counsel
The Florida Bar
File No. 2003-51, 109(15C)

-----Original Message-----

From: Eliot I Bernstein [mailto:iviewit@direcway.com]
Sent: Sunday, February 02, 2003 8:12 AM
Subject: FW:
Importance: High
Sensitivity: Confidential

This is really sick stuff re our patent attorney Raymond Joao . In 5/99 while representing IVIEWIT Joao says his next patent is in digital cameras!!! Also shows 6 guys from Meltzer jump to Proskauer, right as PR views my products.

THIS DOES SAY THAT JOAO HAS A PATENT FOR DIGITAL CAMERAS AND REMOTE CONTROL APPS , TWO OF OUR INVENTIONS . READ ON. THIS IS SICK !!!!!

LI LAW / A Varied Background Is His Trademark / Engineering, patent experience helps specialist in copyright law

Date: 05-03-1999; Publication: Newsday; Author: Manny Topal

LAW / A Varied Background Is His Trademark / Engineering, patent experience helps specialist in copyright law

Manny Topal

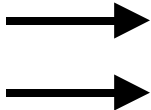

RAYMOND A. Joao is a man for all seasons. He is an engineer, and an inventor who has been awarded nine patents and has another 20 pending. He has worked on designs of electronic warfare and strategic defense systems and software. He also has an MBA. Putting it all together, he is now a lawyer and heads the Intellectual Property Rights / Technology group at the Mineola-based law firm of Meltzer, Lippe. Coming from law firms in Yonkers and Manhattan, **Joao**, 38, joined the Mineola firm in February. His emerging area of law covers trademarks, copyrights and patents - and he expects Long Island's growing technology sector will be deeply involved with intellectual property law because of its reliance on the Internet. The growth of the Internet and the information age, he said, has had a dramatic impact on the law practiced on Long Island. "There's a lot of technology here," **Joao** said, "but where it used to be predominantly defense related, now most of that technical talent has had to be converted to commercial." You see that in the Internet, and you see it with the advent of all these Internet and software companies springing up all over



Lorraine Christine Hoffman, Esq.
Assistant Staff Counsel
The Florida Bar
File No. 2003-51, 109(15C)

the Island . . . Everything on the Internet is computer driven. Methods of doing business are starting to be patentable. That's all because of the information age." He added, "Now you are going to see more lobbying efforts on behalf of the Internet companies and software companies, whereas before, you saw most of the lobbying for insurance companies, banks, tobacco, NRA. "You're going to see lobbying for copyright owners, for patent owners, for software companies and international companies . . . once people realize what they have to do to protect themselves, to protect their intellectual property and to enforce those rights, Long Island is going to be an even better place to live and work." All of that will create more demand for attorneys who specialize in intellectual property law. **Joao** also sees a need for people like himself - with scientific and technical backgrounds. One of his pending patents is a system of monitoring vehicles over the Internet, using the Global Positioning System, and another is for digital camera technology. He just received a patent for a financial transaction notification system and a method of managing employee benefits online. Still, he's drawn to the law. Intellectual property law is changing and evolving rapidly because of the growing use of the Web and Internet. Laws are being tested in several areas that had gone unnoticed before, such as the use of domain names for Web sites. As an example, **Joao** said, somebody claimed the domain name McDonald's. That person was the first to use the domain name, but the effort didn't work. McDonald's, the fast-food giant, earned the right to use its name on the Web, because domain names are considered the same as trademarks. "I always wanted to be a lawyer," **Joao** said, "and I always loved technology, so I ended up getting degrees in engineering. Then I started getting my own patents and I grew more interested in the business aspect of things, so I went out and got an MBA in business finance." While working as an engineer at Sperry in Lake Success, **Joao** earned a law degree from St. John's University, and the marriage was made. "It seemed natural, combining patent law, intellectual property law and engineering," he said.

And shortly thereafter he grows his patents again from 20 to 50:

DOING BUSINESS WITH: LAW FIRMS / From Elderly To Internet: Law's New Domains

By Manny Topol. STAFF WRITER

"It's an industry that people are trying to get in," he said. "If you have a computer, you can do it. This area is explosive." **Joao** is also an electrical engineer and an inventor who has been awarded about 10 patents and has about another 40 to 50 patent-pending inventions. He also has an MBA from City University.

We submit Mr. Joao's response as [Exhibit D](#)

Further Mr. Wheeler is confirming that he has sent Mr. Rubenstein patent materials and that Mr. Rubenstein is in receipt:



Lorraine Christine Hoffman, Esq.
Assistant Staff Counsel
The Florida Bar
File No. 2003-51, 109(15C)

-----Original Message-----

From: [Christopher Wheeler](mailto:CWheeler@proskauer.com) [mailto:CWheeler@proskauer.com]
Sent: Wednesday, February 24, 1999 4:47 PM
To: alps@netline.net
Subject: Jenex deal for iviewit -Reply

** High Priority **

I sent Irwin a copy of the agreement by fax. I received your E-mail—we have confirmed that Ken received it as well—we will be back in touch with you concerning the patent—any response to my copyright letter?

Also, please make sure you return the corporate material after you have signed it.

Regards,
Chris

Further we submit that Rubenstein was being summoned to meetings to discuss problems that were being questioned regarding Raymond Joao's patent filings

-----Original Appointment-----

From: eib [mailto:alps@netline.net]
Sent: Wednesday, June 02, 1999 2:44 PM
To: [Proskauer Rose LLP Wheeler, Christopher C. \(E-mail\); Proskauer Rose LLP Rubenstein, Kenneth \(E-mail\); Proskauer Rose LLP Healy, Kevin J. \(E-mail\); Joao, Raymond A. Meltzer, Lippe, Goldstein, Wolf & Schlissel, P.C. \(E-mail\); iviewit.c \(E-mail\)](mailto:Proskauer Rose LLP Wheeler, Christopher C. (E-mail); Proskauer Rose LLP Rubenstein, Kenneth (E-mail); Proskauer Rose LLP Healy, Kevin J. (E-mail); Joao, Raymond A. Meltzer, Lippe, Goldstein, Wolf & Schlissel, P.C. (E-mail); iviewit.c (E-mail))
Subject: [Ray Joao to come to Florida to discuss iviewit issues](#)
When: Thursday, June 10, 1999 12:00 AM to Tuesday, June 15, 1999 12:00 AM (GMT-05:00) Eastern Time (US & Canada).
Where: Phone

Another correspondence whereby Rubenstein was to opine on the strength of the patents that were being claimed to be filed



Lorraine Christine Hoffman, Esq.
Assistant Staff Counsel
The Florida Bar
File No. 2003-51, 109(15C)

-----Original Appointment-----

From: EIB [mailto:alps1@bellsouth.net]
Sent: Thursday, May 27, 1999 3:19 PM
To: Bernstein, Simon L. (E-mail); Joao, Raymond A. Meltzer, Lippe, Goldstein, Wolf & Schlissel, P.C. (E-mail); **Proskauer Rose LLP Wheeler, Christopher C. (E-mail)**; **Proskauer Rose LLP Healy, Kevin J. (E-mail)**; **Proskauer Rose LLP Rubenstein, Kenneth (E-mail)**
Subject: Ray Joao - MEETING FOR PATENT STRENGTH
When: Wednesday, June 02, 1999 2:00 PM-4:00 PM (GMT-05:00) Eastern Time (US & Canada).
Where: Proskauer Rose for Teleconference

Chris & Kevin is this time OK for you?

And another meeting where Rubenstein is requested to speak with Hassan Miah

-----Original Appointment-----

From: iviewit [mailto:alps@netline.net]
Sent: Monday, June 07, 1999 10:52 PM
To: iviewit; iviewit.com (E-mail); Joao, Raymond A. Meltzer, Lippe, Goldstein, Wolf & Schlissel, P.C. (E-mail); **Proskauer Rose LLP Wheeler, Christopher C. (E-mail)**; **Proskauer Rose LLP Rubenstein, Kenneth (E-mail)**; **Proskauer Rose LLP Healy, Kevin J. (E-mail)**; **The Goldman Sachs Group, Inc. Friedstein, Jefferey (E-mail)**; **The Goldman Sachs Group, Inc. Friedstein, Jefferey (E-mail 3)**; **The Goldman Sachs Group, Inc. Kane, Donald G. (E-mail)**; **Xing Technology Corporation Miah, Hassan (E-mail)**; **Rosman, Richard D. (E-mail)**
Subject: Hassan and technician out to review iviewit patent information.
When: Friday, June 11, 1999 12:00 AM to Saturday, June 12, 1999 12:00 AM (GMT-05:00) Eastern Time (US & Canada).
Where: Florida - Proskauer

**Spoke with Hassan he will call back with exact travel times -
Friday is day to discuss patent and related issues.**

Although this next message appears in the corporate record the Company maintains that Mr. Rubenstein never sent this mail and it was disingenuously inserted into the record and based on his deposition statements that he is not sure if he has records we respectfully ask that the Florida Bar ask for procurement of the original email sent by Mr. Rubenstein, which under deposition he states he is unsure of if he keeps records for emails. By the by, it makes one question why he was planning on attending this meeting at all if he had nothing to do with the patents.and Hassan Miah who he says in deposition he never heard the name?



Lorraine Christine Hoffman, Esq.
Assistant Staff Counsel
The Florida Bar
File No. 2003-51, 109(15C)

-----Original Message-----

From: [Kenneth Rubenstein \[mailto:KRubenstein@proskauer.com\]](mailto:KRubenstein@proskauer.com)
Sent: Tuesday, June 01, 1999 2:58 PM
To: simon@adelphia.net; rjoao@mlg.com; alps@netline.net;
CWheeler@proskauer.com; KHealy@proskauer.com
Subject: Updated: Ray Joao - MEETING FOR PATENT STRENGTH -
Reply

I am sorry but I am not available on Wed. or Thurs.

It is also interesting to note that this email that is questionable shows that Mr. Rubenstein is emailing Board members, has their addresses and Eliot Bernstein is the alps email address listed whom in deposition he claims he does not know.

We will now submit evidence regarding Mr. Wheeler in relation to his deposition statements and evidence contrary to such deposition testimony.

From Mr. Wheeler's deposition:

20	Q. And do you remember who that patent
21	counsel was?
22	A. It was a gentleman named Ray Joao at a
23	firm, Meltzer, et cetera.
24	Q. Meltzer Lippy?
25	A. I believe so.



Lorraine Christine Hoffman, Esq.
Assistant Staff Counsel
The Florida Bar
File No. 2003-51, 109(15C)

1 Q. At the time that matter was referred out,
2 was there another individual who worked on the patent
3 matter as well as Meltzer Lippy, if you're aware of
4 that person? Anyone other than Ray Joao?

5 A. No, I - by the time I was in the process,
6 the only one I knew of was Ray Joao.

7 Q. How about Ken Rubenstein? 

8 A. I don't believe Ken --

9 MR. TRIGGS: Object to form. What's your
10 question about Ken Rubenstein?

11 Q. Was he involved in the patent process or
12 any of the proceedings or services provided with
13 regard to the patents?

Freudian Slip

14 MR. TRIGGS: Object to the form. 

15 A. No. He - he was -- First of all, I don't
16 believe he worked -- I believe he worked at Proekauer
17 at the time and not at Meltzer - Meltzer Lippy. Is
18 that the name of the firm? And secondly, he - his
19 involvement was only to -- He - he - he obviously is
20 a - one of our patent contacts and his - his --

21 Q. Now, when you mean he, you mean Ken
22 Rubenstein?

23 A. Ken Rubenstein.

24 MR. TRIGGS: Let him answer the question.

25 You can ask any clarifying questions after he's



Lorraine Christine Hoffman, Esq.
Assistant Staff Counsel
The Florida Bar
File No. 2003-51, 109(15C)

25

1 done. And Chris, if you can answer the question
2 he's asking you.
3 A. Okay. So the answer is no, Rubenstein
4 didn't do any patent work on it.
5 Q. Now, with regard to the services provided
6 to the iviewit entities, you stated previously there
7 is no written retainer agreement for the first part of
8 the relationship, is that correct?
9 A. Correct.
10 Q. And you said that went on until about
11 midyear you thought? Midyear 1999. Is that correct?
12 A. That's correct.
13 Q. So from January through approximately July
14 there was no written retainer agreement?
15 A. No written agreement.
16 Q. Okay. What was the oral agreement, to the
17 best of your recollection?
18 A. The oral agreement was we - they would
19 come in and request services, we would provide the
20 services, and they would pay for them at our normal
21 hourly rates.

We now submit a letter penned by Mr. Wheeler in 1/99 regarding Proskauer Rose securing patents and nothing to do with any outside firms.



Lorraine Christine Hoffman, Esq.
Assistant Staff Counsel
The Florida Bar
File No. 2003-51, 109(15C)

Christopher C. Wheeler

Member of the Firm

Direct Dial 561.995.4702

cwheeler@proskauer.com

January 8, 1999

Eliot I. Bernstein
500 SE Mizner Boulevard
Suite 102
Boca Raton, FL 33432-6080

Re: Iviewit Legal Work

Dear Elliott:

I apologize for the delay in getting back to you. Our year end was quite hectic, but we are now focusing on your project and we are prepared to devote our full resources to it. We have reviewed your proposed business plan and offering with great interest. In helping you move this matter ahead, we would propose the following:

1. Formation of Corporation

We recommend that we immediately form a Florida corporation on your behalf. We would propose that the corporation be named Iviewit Corp. or Iviewit Corporation. We would also propose that the Florida corporation have 5 million authorized shares of common stock and one class of preferred stock. The common stock would be a 1¢ par value. The corporation would be formed immediately (we anticipate this could be completed within one or two days) and would be a C Corporation. The fees and costs associated with the formation would approximate between \$1,000 and \$1,500;

2. Additional Corporate Documentation

We would recommend that shareholders' agreements and perhaps employment contracts be prepared at this time. The shareholders' agreement is necessary because individuals other than yourselves will be involved as shareholders. The employment agreements, while not absolutely necessary, would help conceptualize your present relationship with the firm and would allow you to define your benefits now prior to the involvement of



Lorraine Christine Hoffman, Esq.
Assistant Staff Counsel
The Florida Bar
File No. 2003-51, 109(15C)

Eliot I. Bernstein
January 8, 1999
Page 2

accredited investors. We anticipate that the preparation of these shareholders' and investment agreements would cost approximately \$2,000 to \$3,000 depending upon their complexity. We would recommend commencing this work immediately and would anticipate that it could be completed within the next three weeks;

3. Protection of Intellectual Property Rights

We strongly recommend trademark and copyright protection of the Iviewit name under Federal law. This protection should be commenced immediately. In addition, if possible, strong consideration should be given to some patent or proprietary protection of the assemblage of software and the methodology used in connection with the production of Iviewit's services. We are presently discussing this protection with our New York intellectual property attorneys and verifying the appropriate fees and costs of each. We would propose to commence the trademark and copyright work immediately, and we would anticipate that the trademark/copyright matter would take approximately a month. The patent work should also be commenced now and may take considerably longer;

4. Offering Circular

In connection with your fund-raising efforts, we would propose to use your present business plan and offering as a base and revise it to provide the appropriate disclaimers and disclosures. In the event you raise capital from a limited number of accredited investors, we would anticipate that the cost of the revision of the offering memorandum would approximate \$5,000 - \$10,000. In the event that you begin to sell to non-accredited investors, we would need to expand the documents significantly. The cost could approximate \$15,000 to \$25,000. We are prepared to commence this work immediately and anticipate that it could be completed within the next few weeks;

5. Additional Corporate Work

From time to time, there will be additional corporate work most probably involving investment banks, underwriters, contracts, general corporate matters and securities matters. We will be available to handle this work on a daily basis. It is difficult to estimate what this would approximate dollar-wise since it will depend on what matters arise.

6. Staffing

We are prepared to dedicate whatever portion of our professionals' time is necessary to handle your matters successfully. We are prepared to offer you continuing corporate, intellectual property and other support as you may require in the years ahead. Your business is important to us and we will fully commit whatever resources are necessary to do the work quickly and to build what we hope will be a long-term relationship.

7. Fees

Generally, we will bill you monthly based on our hourly billing rates plus out-of-pocket expenses. All tactical and strategic decisions would be discussed with you and other members of your management team as appropriate.



Lorraine Christine Hoffman, Esq.
Assistant Staff Counsel
The Florida Bar
File No. 2003-51, 109(15C)

Eliot I. Bernstein

January 14, 1999
Page 3
The attorneys who would be assigned to your matter have various billing rates. We would anticipate that most of your work be done by me, Rocky Thompson, Gayle Coleman and Mara Lerner Robbins. Our billing rates are \$385, \$275, \$220, and \$165 respectively. Please note that in addition to attorneys' fees, you would also be responsible for out-of-pocket expenses for the cost of mailing, telephone, photocopying, faxes, hand deliveries and the like.

We are in a service business and that is the primary orientation of our Firm; we believe in a thoughtful but rapid response to our clients needs in delivering value for our client's money. We believe we have a non-nonsense approach in providing the best in legal services. We welcome the opportunity to handle Iviewit's initial legal work and look forward to continuing to service your future legal needs.

Please call me at your earliest convenience. We are prepared to form the corporation and commence trademark and copyright protection upon your authorization.

Sincerely,

Christopher C. Wheeler

CCW/gb



Lorraine Christine Hoffman, Esq.
 Assistant Staff Counsel
 The Florida Bar
 File No. 2003-51, 109(15C)

Another document relating to Rubenstein and Wheeler working on the Iviewit patents for Proskauer Rose:

FEB 18 1999 14:39 FR PROSKAUER ROSE 561 241 7145 TO 089440017001441 P.02/03

PROSKAUER ROSE LLP

2255 Glades Road
 Suite 340 West
 Boca Raton, FL 33431-7360
 Telephone 561.241.7400
 Elsewhere in Florida
 800.432.7746
 Fax 561.241.7145

NEW YORK
 LOS ANGELES
 WASHINGTON DC
 CLIFTON NJ
 PARIS

Christopher C. Wheeler
 Member of the Firm
 Direct Dial 561.995.4702
 cwheeler@proskauer.com

VIA FAX

February 18, 1999

Mr. Eliot I. Bernstein
 iviewit, Inc.
 500 S.E. Mizner Boulevard
 Suite 102
 Boca Raton, FL 33432-6080

Re: Status Report Regarding Various Matters

Dear Eliot:

I thought it best to confirm the status of a number of loose ends:

1. I have spoken to Gayle Coleman about the application of the "confidentiality language" to the "web site". She is calling you directly to discuss the preparation of this language. This should be completed no later than today;
2. We have revised the Jenex language to deal with the broker/dealer issue. As I dictate this letter, the revised document is being faxed to you. We need you to review the document and give us your comments prior to our forwarding it to Irwin Newman at Jenex. Once you have had an opportunity to review the document, please call us concerning your comments;
3. I have traded phone calls with our patent expert, Ken Rubenstein. Since there seems to be some confusion as to what Ken needs in order to determine the patentability of your process, I am arranging a conference call between you, me and Ken in which we can discuss it. After that discussion, I will also provide you with a proposal as to how we should proceed and what fees and costs will be involved. I know that your father was concerned as to the patent expense. We will need to give you a more definite answer and thereafter receive authorization from you as to the expenditure of these monies;

089440017-001 BRUB1/219897 v1

02/18/99 01:16 PM (2743)



Lorraine Christine Hoffman, Esq.
Assistant Staff Counsel
The Florida Bar
File No. 2003-51, 109(15C)

FEB 18 1999 14:40 FR PROSKAUER ROSE 561 241 7145 TO 0894#40017001#41 P.03/03

PROSKAUER ROSE LLP

Mr. Eliot I. Bernstein
February 18, 1999
Page 2

4. We just received your Corporate Minute Book, and I have asked Mara Lerner Robbins of this office to follow up and complete your Corporate By-laws, your initial series of Corporate Minutes and arrange for the issuance of stock to you. I have also asked Mara to follow up with respect to a fictitious name affidavit for iviewit; and
5. With respect to copyright trademark protection, I have also asked Mara to coordinate trademark copyright protection so that you may protect the iviewit name. Today she will be faxing to you the fee information in order to secure authorization from you to proceed and finalize that matter.

I believe this covers all present loose ends. If you have any questions whatsoever, please call me.

We will keep you advised.

Best regards.

Cordially,

Christopher C. Wheeler

CCW/gb

cc: Albert W. Gortz
Jerry Lewin

0894/40017-001 BRL/B1/219697 v1

02/18/99 01:16 PM (2743)

** TOTAL PAGE.03 **



Lorraine Christine Hoffman, Esq.
Assistant Staff Counsel
The Florida Bar
File No. 2003-51, 109(15C)

And now from Mr. Wheeler's deposition:

17 Q. Okay. Now, I want to direct your
18 attention more specifically, sir, to paragraph three.
19 It's actually numbered three --
20 A. Right.
21 Q. -- on that first page?
22 A. Right.
23 Q. And it talks about a discussion with a
24 Mr. Ken Rubenstein? You -- I'm sorry. Go ahead.
25 A. You mean a potential discussion.



Lorraine Christine Hoffman, Esq.
Assistant Staff Counsel
The Florida Bar
File No. 2003-51, 109(15C)

37

1 Q. Okay.

2 A. Okay.

3 Q. So you were contacting Ken Rubenstein?

4 A. I was trying to.

5 Q. Did you ever contact Mr. Rubenstein?

6 A. I can't tell you I did or didn't. I'd
7 have to see the follow-up.

8 Q. Would that be reflected in the billing
9 statements that you provided to iviewit?

10 A. Yes.

11 Q. Do you know if Mr. Rubenstein's name is
12 mentioned in the billing statements to iviewit --

13 A. Yes.

14 Q. -- from Proskauer Rose?

15 A. Yes. They might answer it -- Right.

16 Q. Are you aware of whether or not the
17 conference call referenced in that paragraph number
18 three ever took place?

19 A. No, I'm not.

20 Q. And it says specifically, and I quote,
21 since there seems to be some confusion as to what Ken
22 needs in order to determine the patentability of your
23 process?

24 A. Right.

25 Q. I'm arranging a conference call between

KEN SCHANZER & ASSOCIATES, INC. (954) 922-2660



Lorraine Christine Hoffman, Esq.
Assistant Staff Counsel
The Florida Bar
File No. 2003-51, 109(15C)

38

1 you, me and Ken in which we can discuss it.

2 A. Right.

3 Q. So was that statement on your part in this
4 letter precipitated by some specific discussion with
5 Mr. Bernstein?

6 A. I don't recall.

7 Q. Did you ever have a discussion with
8 Mr. Bernstein about Proskauer Rose providing an
9 opinion with regard to the patentability of any of
10 these processes?

11 A. No.

12 Q. What was the process that was being
13 discussed or was mentioned in your letter or reference
14 to Eliot?

15 MR. TRIGGS: Object to form.

16 Q. Let me rephrase it. What process were you
17 referring to in your letter?

18 A. We were referring to Eliot's technology.
19 Whatever that technology was.

20 Q. Okay. Well, let's go back to that, to the
21 technology issue, because I think you had provided a
22 little testimony about that before, saying it was a
23 portal?

24 A. Right.

25 Q. Okay. Was there anything more specific on

KEN SCHANZER & ASSOCIATES, INC. (954) 922-2660



Lorraine Christine Hoffman, Esq.
Assistant Staff Counsel
The Florida Bar
File No. 2003-51, 109(15C)

And again his letter to Richard Rosman clearly emphasizes that he has committed perjury under deposition as he over and over claims “we” and the document is on Proskauer Rose letterhead.



Christopher C. Wheeler
Member of the Firm

Direct Dial 561.995.4702
cwheeler@proskauer.com

April 26, 1999

Mr. Richard Rosman
Lewinter and Rosman
16255 Ventura Blvd., Suite 600
Encino, CA 91436

Re: iviewit, Inc.

Dear Richard:

Under separate cover I have forwarded you a revised Confidentiality Agreement.

As you know we have undertaken representation of iviewit, Inc. (“iviewit”) and are helping them coordinate their corporate and intellectual property matters. In that regard, we have reviewed their technology and procured patent counsel for them. We believe the iviewit technology is far superior to anything presently available with which we are familiar. Iviewit has filed a provisional patent application on a method for providing enhanced digital images on telecommunications networks. We are advised by patent counsel that the process appears novel and may be protected by the patent laws. While in all matters of this sort, it is far to early to make any final pronouncements, we do believe that there is an extremely good prospect that iviewit will protect their process which is novel and superior to any other format which we have seen.

Very truly yours,

Christopher C. Wheeler

CCW/gb

0894/40017-001 BRLIB/1/227137 v1

04/22/99 03:57 PM (2743)

And a signed and distributed statement to an Investor from Mr. Wheeler:



Lorraine Christine Hoffman, Esq.
 Assistant Staff Counsel
 The Florida Bar
 File No. 2003-51, 109(15C)

JUN 10 1999 11:37 FR PROSKAUER ROSE 561 241 5280 TO 4174470H P.02/06

PROSKAUER ROSE LLP

2255 Glades Road
 Suite 340 West
 Boca Raton, FL 33431-7300
 Telephone 561.241.7400
 Elsewhere in Florida
 800.432.7746
 Fax 561.241.7145

NEW YORK
 LOS ANGELES
 WASHINGTON
 NEWARK
 PARIS

Christopher C. Wheeler
 Member of the Firm

Direct Dial 561.985.4702
 cwheeler@proskauer.com

June 9, 1999

Via Fax

Mr. Gemal Seede
 Nercubator
 30 W. Green Street
 Pasadena, CA 91105

Dear Mr. Seede:

At the request of Alan Epstein, I am forwarding the enclosed two Confidentiality Agreements to you. I would appreciate your signing and returning them to me.

We have undertaken representation of iviewit, Inc. ("iviewit") and are helping them coordinate their corporate and intellectual property matters. In that regard, we have reviewed their technology and procured patent counsel for them. We believe the iviewit technology is far superior to anything presently available with which we are familiar. iviewit has filed a provisional patent application on a method for providing enhanced digital images on telecommunications networks. We are advised by patent counsel that the process appears novel and may be protected by the patent laws. While in all matters of this sort, it is far too early to make any final pronouncements. We do believe that there is an extremely good prospect that iviewit will protect their process which is novel and superior to any other format which we have seen.

Sincerely,

Christopher C. Wheeler

CCW/gb

cc: Alan J. Epstein - Via Fax

0694/40017-001 BRLIB1/232305 v1

06/09/99 06:52 PM (2743)

and further in his deposition



Lorraine Christine Hoffman, Esq.
Assistant Staff Counsel
The Florida Bar
File No. 2003-51, 109(15C)

2 Q. Now, that same paragraph three talks
3 about -- And I'll refer you to the last sentence of
4 that paragraph? Well, actually, let's go to the next
5 sentence after the one I referred you to previously
6 which was, after that discussion, I will also provide
7 you with a proposal as to how we should proceed and
8 what fees and costs will be involved? Do you know if
9 this was ever done?
10 A. I don't know if it was done.
11 Q. Where would that proposal have come from,
12 if it was prepared?
13 MR. TRIGGS: Object to the form.
14 A. It could have come from me or it could
15 have come from our IP people.
16 Q. IP meaning intellectual property?
17 A. Right. Or it could not have come.
18 Q. Okay. If it - if it was produced in any
19 kind of form, that would exist in the files of
20 Proskauer Rose?
21 A. I'm sure it would.
22 Q. How about the last sentence of that same
23 paragraph?
24 A. What would you like to know?
25 Q. Well, we will need to give you a more

And from Mr. Wheeler's files a conversation he had with Kevin Healy regarding the Iviewit patents and to keep the patent in the inventors name and not assign it to the Company which is exactly opposite of what Mr. Wheeler ended up doing which resulted in 9-10 corporations being formed and has put the patents in extreme jeopardy. Mr. Wheeler suggested changing the corporate structure and advised us that he was protecting the patents and in essence his current lawsuit attempts to sue the Company with the patents although he provides no bills to that Company.



Lorraine Christine Hoffman, Esq.
Assistant Staff Counsel
The Florida Bar
File No. 2003-51, 109(15C)

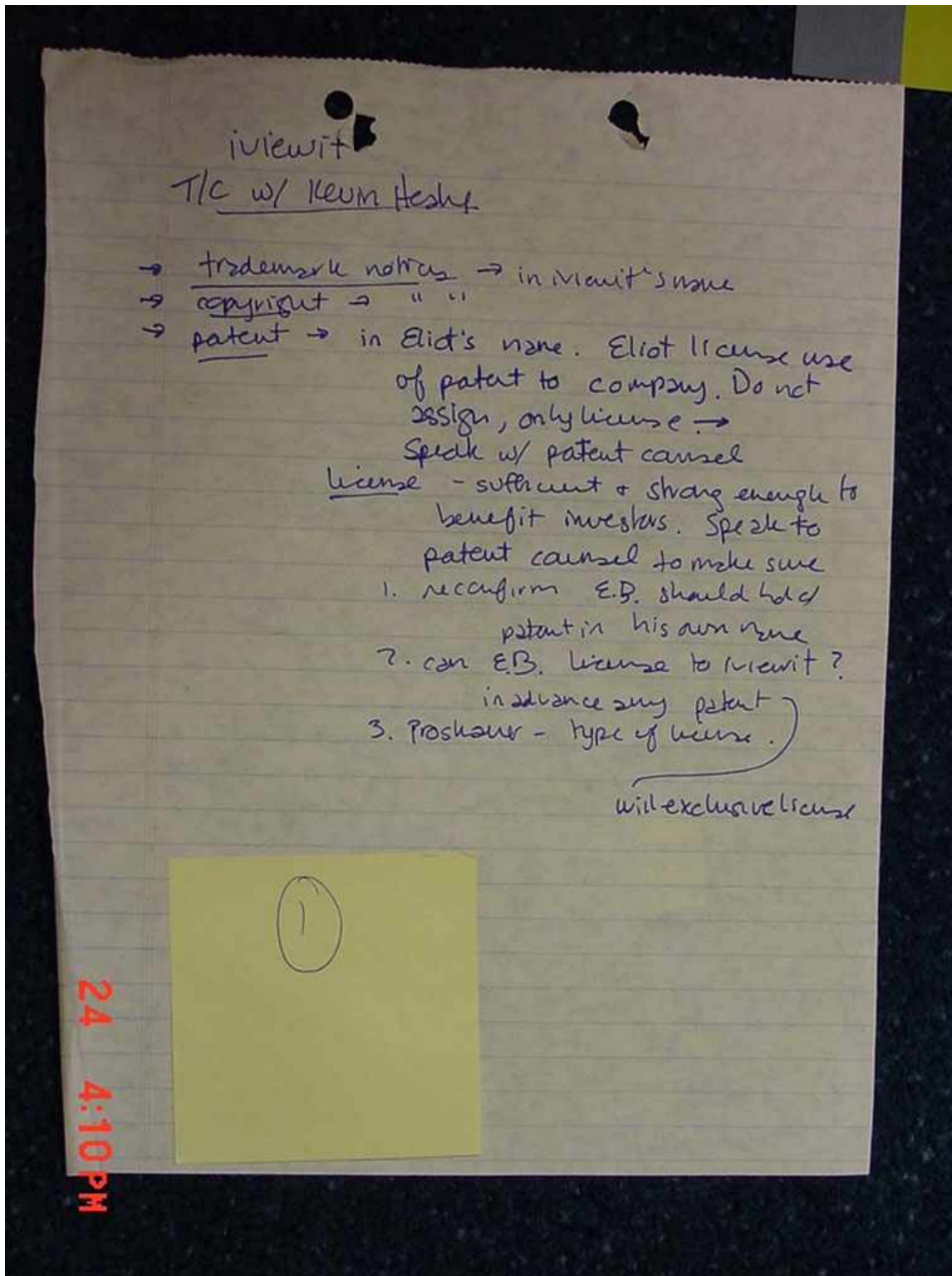



Lorraine Christine Hoffman, Esq.
Assistant Staff Counsel
The Florida Bar
File No. 2003-51, 109(15C)

And further Excerpts from a 5.4.99 Business Plan, Wheeler who says he did not know of video technology existed before 6/99 had authored and reviewed the business plan and as on the distribution list of the following email.



Lorraine Christine Hoffman, Esq.
 Assistant Staff Counsel
 The Florida Bar
 File No. 2003-51, 109(15C)

Page 1 of 3

Eliot I. Bernstein

Subject: FW:
Importance: High
Sensitivity: Confidential

-----Original Message-----

From: EIB [mailto:alps1@bellsouth.net] **On Behalf Of** iviewit, inc. (E-mail)
Sent: Tuesday, May 04, 1999 7:29 AM
To: James F. Armstrong (E-mail); Simon L. Bernstein (E-mail); Andrew R. Dietz (E-mail);
 Donna Dietz (E-mail); Theodore D. Lanzaro (E-mail); Guy Iantoni (E-mail); James A. Osterling
 (E-mail); Kevin J. Healy (E-mail); Christopher C. Wheeler (E-mail); Jude Rosario (E-mail)
Subject: Business plan revisions

iviewit intends to establish itself as a global leader in virtual multimedia display by licensing its patented virtual imaging and streaming video technologies as well as utilizing these proprietary technologies to build an e-commerce portal with production values exceeding those of any existing portals. **iviewit** will generate revenues from the licensing of proprietary technologies, strategic e-commerce revenue sharing agreements, strategic advertising agreements, and by establishing an image and video production capability. In the **iviewit** web site, products are represented in a high definition virtual reality environment where the end user can control and manipulate the product environment to view multifaceted dimensions with high-powered magnification. **iviewit** video technology enables the user to see TV quality full motion and full screen Internet video without the standard grainy picture and lengthy download times. Simply put, **iviewit** technology redefines the quality of the virtual viewing experience.

The **Company** intends to apply this pioneering process to a multitude of products focusing on the core markets mentioned herein and then expanding to create a virtual reality shopping mall. **iviewit's** patented speed and imaging technologies will differentiate **iviewit** from portals such as Lycos, Excite, AOL, Yahoo and Ebay, and create a new Internet E-commerce platform.

Virtual Reality Experience - Have you ever wished you could climb inside a picture and see the rest of the surroundings as if you were there? Utilizing **iviewit's** revolutionary new technology and processes, you can do just that.

The **Company's** imagery enables you to experience a location or object, allowing you to;

- ✦ Maneuver within an image using mouse commands
- ✦ zoom in and zoom out, up to an amazing 1700 times magnification with minimal pixelation and distortion
- ✦ Rotate the image to obtain a full 360° panoramic view

4/16/2003



Lorraine Christine Hoffman, Esq.
 Assistant Staff Counsel
 The Florida Bar
 File No. 2003-51, 109(15C)

iviewit's clarity and speed brings **3-D** images onto the computers full screen for your viewing pleasure
iviewit represents a pivotal enhancement to global E-commerce. Currently, most E-commerce occurs across a two-dimensional plane; websites are simply brochures posted to the web. Products bought and sold use flat lifeless pictures and text. **iviewit technology is remarkably different because the product appears to come alive without distortion, enabling the user to closely inspect all dimensions of the product.** The **iviewit** web site features integrated voice overlays and a live videoconference capability enabling buyer and seller to engage in a real-time discussion. This live interface adds a dynamic new element to E-Commerce; **THE LIVE AND PERSONAL SALESMAN.** All Internet websites currently lack the personal sales approach. This advancement in site design will give the **Company's** vendors & customers a significant advantage over current web sites.

iviewit allows this enhanced digital imaging technology to occur without the need for complicated plug-ins or special software. Companies with existing web sites will have the ability to link their site directly to the virtual pages maintained by **iviewit**, or create new websites based entirely on the **iviewit** process.

The **Company's** offices are located at:
 500 SE Mizner Boulevard
 Suite 102
 Boca Raton, FL 33432-6080
 (800)519-0234
 Eliot I. Bernstein, President

The **Company's** Attorneys for corporate and business matters are:
 Proskauer Rose LLP
 One Boca Place
 Suite 340 West
 Boca Raton, FL 33431
 561.241.7400
 Christopher C. Wheeler, Esq.

The **Company's** Patent Attorneys are:
Meltzer, Lippe, Goldstein, Wolf & Schlissel, P.C.
 The Chancery
 190 Willis Avenue
 Mineola, NY 11501
 516.747.0300
 Raymond A. Joao, Esq.

Proskauer Rose LLP

4/16/2003

 New York, NY
Ken Rubenstein, Esq.



Lorraine Christine Hoffman, Esq.
Assistant Staff Counsel
The Florida Bar
File No. 2003-51, 109(15C)

And now from his deposition you will note Mr. Wheeler addressing his patent billings in his bill by answering that he cannot recall and has NO notes or backup regarding these most highly critical meetings regarding the iVIEWIT patents:



Lorraine Christine Hoffman, Esq.
Assistant Staff Counsel
The Florida Bar
File No. 2003-51, 109(15C)

146

1 A. Oh, all right.

2 Q. -- does that refresh your recollection?

3 A. Yes.

4 Q. How about the next entry? I mean, we
5 talked about the fact that you were doing
6 transactional work and involved with the business
7 side. You indicated in your earlier testimony you had
8 nothing to do with regard to the intellectual property
9 side or the transactional side of the whole
10 transaction.

11 A. That's correct.

12 Q. I'm looking at an entry dated January
13 14th, 1999, for a half hour. I'm assuming .5 is a
14 half hour billing increment time?

15 A. Right.

16 Q. Follow up on status on intellectual
17 property review and iviewit Corporation new
18 incorporation?

19 A. Right.

20 Q. What intellectual property review were you
21 involved with?

22 MR. TRIGGS: Object to the form.

23 Q. What did you review in that billing
24 statement in that particular entry, sir? What did you
25 do in that particular entry?

KEN SCHANZER & ASSOCIATES, INC. (954) 922-2660



Lorraine Christine Hoffman, Esq.
Assistant Staff Counsel
The Florida Bar
File No. 2003-51, 109(15C)

147

1 A. Well, I can't tell you exactly what I did
2 a couple of years ago, but this would reflect that
3 this was logistics. I was -- On the status of the
4 intellectual property review. In other words, how
5 were we going to handle the review of the intellectual
6 property matters. And you can't tell as to what
7 portion of this component relates to that and what
8 portion of that relates to new incorporation. I mean,
9 it was all built into one bundle. But obviously, I
10 was make an inquiry as to how we were going to handle
11 that.

12 Q. And who were you making that inquiry to?

13 A. It doesn't say.

14 Q. The follow up on new corporation, would
15 that have been internal within the firm?

16 A. Yes.

17 Q. Do you have any reason to believe the
18 follow-up on the intellectual property would have been
19 made to any other party besides within the firm?

20 A. Well, it's internal right now because it
21 hadn't been referred out yet.

22 Q. How about, who is G. Goldman? Is that a
23 member of the firm as well?

24 A. That was an associate. I'm sorry -- Yes,
25 that was an associate.

KEN SCHANZER & ASSOCIATES, INC. (954) 922-2660



Lorraine Christine Hoffman, Esq.
Assistant Staff Counsel
The Florida Bar
File No. 2003-51, 109(15C)

148

1 Q. Gregg Goldman?

2 A. Gregg Goldman.

3 Q. Okay. I'm referring you to the entry of
4 January 26, 1999.

5 A. Which one?

6 Q. January 26, 1999.

7 A. Right. I don't know Mr. Goldman. I mean,
8 I did not talk to Mr. Goldman, that I can recall.

9 MR. TRIGGS: Again, Steve, on this topic,
10 I'm not going to instruct Mr. Wheeler not to
11 answer based on relevancy, but you know that
12 this June 18 statement is not an invoice that we
13 contend is unpaid and doesn't form the basis of
14 our claims. So you're again not covering topics
15 that are relevant to the case.

16 MR. SELZ: Well, I think I'm covering a
17 topic which is relevant. Based on his earlier
18 testimony, there were no issues concerning
19 patents and the only scope of Proskauer's work
20 was simply transactional or with regard to
21 trademark or copyright, which is what his
22 earlier testimony was.

23 MR. TRIGGS: If your bottom line
24 suggestion is that Proskauer did any improper
25 patent related work, as you know, that subject

KEN SCHANZER & ASSOCIATES, INC. (954) 922-2660



Lorraine Christine Hoffman, Esq.
Assistant Staff Counsel
The Florida Bar
File No. 2003-51, 109(15C)

149

1 was dealt with --

2 MR. SELZ: Well, but --

3 MR. TRIGGS: -- by means of a motion in
4 limine.

5 MR. SELZ: Wait, is this a speaking
6 objection, then?

7 MR. TRIGGS: No.

8 MR. SELZ: Okay.

9 MR. TRIGGS: I'm pointing out the law on
10 this piece and the status of this case.

11 MR. SELZ: I understand that. But I
12 certainly have a right to inquire as to whether
13 or not he was mistaken in his earlier testimony
14 about the scope of Proskauer's representation of
15 iviewit or not. And I'm not - I can't be
16 limited because of his earlier testimony.

17 MR. TRIGGS: Look, and like I said, I'm
18 not instructing him not to answer. All I'm
19 telling you is, as I indicated earlier, that I
20 think a day is fair with Mr. Wheeler, and choose
21 your time wisely.

22 A. Goldman is obviously an associate who
23 worked for us and was, I'm sure, in coordination with
24 Ms. Robbins working on looking at the business plan to
25 see how we should approach, whether there was

KEN SCHANZER & ASSOCIATES, INC. (954) 922-2660



Lorraine Christine Hoffman, Esq.
Assistant Staff Counsel
The Florida Bar
File No. 2003-51, 109(15C)

150

1 something we could get our arms around that could be
2 patented. It hadn't been decided how it was going to
3 be handled yet.

4 Q. Okay.

5 A. I mean, identifying whether it was even
6 worthwhile. And obviously they conducted on line
7 Internet search, even seeing if there were -- I'm not
8 exactly familiar with how they - what they do on line
9 on their Internet searches, but they look for
10 conflicts and they look for - look for -- They look -
11 they - they research and look for items whether it
12 seems like it's been handled before. But I can't - I
13 can't speak in detail to it because I'm not an expert
14 in that area. So that's obviously more logistics on
15 that.

16 Q. Okay. How about on the next page, page 3
17 of that statement, January 28th, 1999, A. Gortz?

18 A. That's my partner.

19 Q. Okay. That's Al Gortz?

20 A. Right.

21 Q. .75?

22 A. Right.

23 Q. Ken Rubenstein call, looks like CF, call
24 from?

25 A. Conference --

KEN SCHANZER & ASSOCIATES, INC. (954) 922-2660



Lorraine Christine Hoffman, Esq.
Assistant Staff Counsel
The Florida Bar
File No. 2003-51, 109(15C)

151

1 Q. Conference?

2 A. -- with Mara Robbins regarding the
3 confidentiality agreement. So Mr. Gortz had a
4 conference with Mara Robbins as to the confidentiality
5 agreement. He also had a conference with Eliot
6 Bernstein and Ken Rubenstein, perhaps introducing
7 them.

8 This again was all at the initial stages,
9 saying this is a new client, we want you to know him,
10 we're probably going to - he's probably going to be in
11 touch with you, and we're going to have some issues to
12 review here.

13 Q. How about the 02/01/1999, conference as to
14 status of intellectual property work?

15 A. Well, yeah, that --

16 MR. TRIGGS: What's the question?

17 MR. SELZ: I want him to see if he can
18 explain the entry.

19 Q. What intellectual property work were you
20 talking about in that particular entry?

21 A. I don't know.

22 Q. Don't have any recollection of what it was
23 for?

24 A. No.

25 Q. Is there any place where there would be a

KEN SCHANZER & ASSOCIATES, INC. (954) 922-2660



Lorraine Christine Hoffman, Esq.
Assistant Staff Counsel
The Florida Bar
File No. 2003-51, 109(15C)

152

1 more complete description of the service provided?

2 A. No.

3 Q. How about on 2/16/99, .25, conference with

4 Mr. Bernstein, call to Mr. Rubenstein. Is that Ken

5 Rubenstein?

6 A. Yes.

7 Q. Can you recall what you spoke to

8 Mr. Rubenstein about?

9 A. No.

10 Q. I didn't think so. How about the next two

11 entries down, 2/17/99, .25, call to Mr. Rubenstein re:

12 patent advice?

13 A. Right.

14 MR. TRIGGS: What's your question?

15 Q. Do you recall what that entry involves or

16 what - what you would explain to Mr. Rubenstein about

17 with regard to patent advice?

18 A. It would be logistics, once again.

19 Q. Now, by logistics you mean --

20 A. How are we going to handle this. Is -

21 is - are you signing it, are we going to refer it out,

22 are we going to - did you receive - did you receive

23 the matter, did you -- But he - he would be definitely

24 a patent person. So the IP there would be patent.

25 Right. But it didn't mean we were dealing with

KEN SCHANZER & ASSOCIATES, INC. (954) 922-2660



Lorraine Christine Hoffman, Esq.
Assistant Staff Counsel
The Florida Bar
File No. 2003-51, 109(15C)

153

1 substantive matters.

2 Q. Well, to determine logistics, would you
3 have to look at the substantive matters at all?

4 MR. TRIGGS: Object to form.

5 Q. If you know. I mean, I'm --

6 MR. TRIGGS: Are you asking him what he
7 did?

8 A. I don't know. I don't do IP work.

9 Q. Sir, with regard to services provided, we
10 talked about corporations and formation of
11 corporations early on, and you testified that
12 obviously the more complex the corporate setup, the
13 more expensive the services would be in establishing a
14 corporation.

15 Do you consider preparation of an
16 application for an employer identification number, an
17 SS-4, to be a complicated matter?

18 A. No.

19 Q. How about preparation of a fictitious name
20 application?

21 A. No.

22 Q. How long do you think those should take,
23 respectively?

24 A. I don't know, but that's a paralegal
25 putting in that time. I don't consider those

KEN SCHANZER & ASSOCIATES, INC. (954) 922-2660

And later from Wheeler deposition



Lorraine Christine Hoffman, Esq.
Assistant Staff Counsel
The Florida Bar
File No. 2003-51, 109(15C)

154

1 unreasonable periods of time.

2 Q. How about the entry 2/23/99, .25, review
3 of correspondence re: patent matters, do you have any
4 recollection of who that correspondence was from?

5 A. No. I'd have to see what the
6 correspondence was. But --

7 Q. How about with regard to the entries on
8 the next page, 2/26/99? L. Gardner, 2.0, prepare
9 proof of publication, file fictitious name
10 application, obtain FEIN number, letter to E.
11 Bernstein regarding FEI number. I understand it's a
12 paralegal, but weren't those some of the same services
13 billed earlier on this billing statement?

14 A. Right. But she could have been -- One's
15 preparing -- I mean, she could continue with the
16 preparation of it. And we don't know it's the same
17 one.

18 Q. Now, this --

19 A. Two hours at \$75 or, let's say it was \$65.
20 I don't know what it was at that time. It was \$60.
21 It would be \$120.

22 MR. TRIGGS: Steve, we'll write that one
23 off. You guys cut the check for the balance.
24 How about that?

25 Q. How about 3/24/99? .50. Call to

KEN SCHANZER & ASSOCIATES, INC. (954) 922-2660



Lorraine Christine Hoffman, Esq.
Assistant Staff Counsel
The Florida Bar
File No. 2003-51, 109(15C)

155

1 Mr. Lewin; conference with Mr. Healy regarding
2 copyright; conference with patent counsel.

3 A. I see it.

4 Q. Okay?

5 MR. TRIGGS: What's your question?

6 Q. Do you have any specific recollection of
7 who that patent counsel was?

8 A. No.

9 Q. How about --

10 A. But I believe it's Ray Joao and myself. I
11 have no recollection, but I believe that's who it is.

12 Q. How about the entry, 3/31/99?

13 A. Of?

14 Q. K. Healy.

15 A. Uh-huh.

16 Q. .25, TC with K. Rubenstein re: patent
17 advice.

18 A. With Eliot Bernstein.

19 MR. TRIGGS: What's your question?

20 A. Oh, K. Rubenstein.

21 Q. Re: patent advice?

22 MR. TRIGGS: What's your question?

23 Q. Do you have any knowledge as to what that
24 entry involves?

25 A. No. It's not my entry.

KEN SCHANZER & ASSOCIATES, INC. (954) 922-2660



Lorraine Christine Hoffman, Esq.
Assistant Staff Counsel
The Florida Bar
File No. 2003-51, 109(15C)

156

1 Q. Does it change your earlier testimony that
2 Proskauer Rose was providing any patent advice or any
3 intellectual properties advice to iviewit?

4 A. No, because if you go up to 3/29/99, the
5 same Guy, Kevin Healy, it shows he had a telephone
6 conference with Raymond Joao regarding patent pending.
7 So chances are he was responding to Ken Rubenstein
8 tell Ken Rubenstein that he got Ray Joao involved.

9 Q. Well, that's speculation, because you
10 don't know for sure.

11 A. You're right.

12 MR. TRIGGS: Steve, you are the one who
13 asked him a question --

14 MR. SELZ: No, I didn't.

15 MR. TRIGGS: -- about a billing entry.

16 That's not his name.

17 A. You asked me if it changed my mind, and I
18 said no. And I'm telling you the reason why it
19 wouldn't change my mind.

20 Q. That's fine. How about Real 3D, there is
21 an entry here on 4/30/99, confirm appointment with
22 Real 3D?

23 A. Right.

24 MR. TRIGGS: What's the date again?

25 MR. SELZ: It's 4/30/99.

KEN SCHANZER & ASSOCIATES, INC. (954) 922-2660



Lorraine Christine Hoffman, Esq.
Assistant Staff Counsel
The Florida Bar
File No. 2003-51, 109(15C)

And later from Wheeler deposition



Lorraine Christine Hoffman, Esq.
Assistant Staff Counsel
The Florida Bar
File No. 2003-51, 109(15C)

166

1 Q. Correct.

2 A. I - I may not - I may or I may have not
3 looked at the agreements, depending upon who had
4 reviewed them and the level of comfort that we had
5 with the person handling it.

6 MR. TRIGGS: Steve, when you get to a
7 breaking point, take like a five-minute break.

8 MR. SELZ: You want to take a five-minute
9 break?

10 MR. TRIGGS: That's fine with me. Two to
11 five minutes. Whatever you guys want. I want
12 to be quick. I want to get the maximum
13 deposition coverage.

14 MR. BERNSTEIN: I need about fifteen.

15 MR. SELZ: How about compromise, say, at
16 ten?

17 MR. BERNSTEIN: Okay.

18 (Brief recess.)

19 Q. (By Mr. Selz) Okay. Who is Hassan Mia?

20 A. He was -- Hassan Mia?

21 Q. Yeah. Hassan Mia.

22 A. He was a friend of Eliot -- Is it Eliot

23 Cohen?

24 Q. Yeah.

25 A. He was a friend of someone's. Eliot or

KEN SCHANZER & ASSOCIATES, INC. (954) 922-2660



Lorraine Christine Hoffman, Esq.
Assistant Staff Counsel
The Florida Bar
File No. 2003-51, 109(15C)

167

1 one of Eliot's contacts who flew in from the West
2 Coast, and he had been purported to be associated
3 with - had sold one of his first high tech companies
4 out and - and then was involved in some way with Real
5 Player or Real Audio or whatever, but my sole contact
6 was when he flew in for the weekend and we met him.
7 Or I believe that's my sole contact.

8 What date is that?

9 Q. 5/24/99. I suspect that's a weekday.

10 A. No, I think it was a weekend. They flew
11 in on a weekend. Wait a minute. 4/24. Let me see.

12 Q. 5/24.

13 A. 5/24.

14 Q. Because you've also got a conference that
15 day with - or, rather, D. Thompson had a conference
16 with you regarding confidentiality issues.

17 A. Okay. Well, maybe Hassan Mia was here
18 twice for longer periods of time. Or I could have
19 talked to Thompson separately.

20 Q. How about this one for 5/26/99, the
21 1.0-hour entry?

22 MR. TRIGGS: What's your question?

23 Q. It says, review of patent; set up patent
24 conference; arrange follow-up on shares. You reviewed
25 the patent?

KEN SCHANZER & ASSOCIATES, INC. (954) 922-2660



Lorraine Christine Hoffman, Esq.
Assistant Staff Counsel
The Florida Bar
File No. 2003-51, 109(15C)

168

1 A. Well, I reviewed what I had. We came
2 back -- If you noticed, we went on the trip on 5/25.
3 At that meeting, for the first time, Eliot displayed
4 to all of us a new product. A video product. And I
5 was driving with his - with his father and with Jerry
6 Lewin in one car and Eliot was in another car, and as
7 we were driving back I said - I asked the question, I
8 said, this new product, is this - what have you done
9 on the patent on this? And Eliot told us all - he was
10 on the phone, he was in another car - he told us all
11 that they hadn't done any work on that yet.

12 So what I did was, I - Eliot had - as he
13 had the patents, he wanted us to lock them up, so I
14 had them locked up. So I pulled - when we returned, I
15 pulled up the locked up patents out to make sure I had
16 them. So I was reviewing them, and we determined we
17 were going to have to set up a conference to make sure
18 he was covered with Joao and everybody to see what to
19 do in view of this new development.

20 So reviewing the patent -- There's
21 reviewing the patent and reviewing the patent. If
22 you're saying reviewing it substantively, no.
23 Reviewing it to see that I have what was supposedly
24 the patent in the right thing and what everyone was
25 going to talk about in the conferences, yes.

KEN SCHANZER & ASSOCIATES, INC. (954) 922-2660



Lorraine Christine Hoffman, Esq.
Assistant Staff Counsel
The Florida Bar
File No. 2003-51, 109(15C)

169

1 Q. Okay. Well, maybe I misunderstood part of
2 your earlier testimony. You said you looked at the
3 patents to figure out whether or not - maybe I'm
4 mistaken - they covered the issue and whether or not
5 to bring it to Joao's attention?

6 A. No, I wasn't looking to see if it covered
7 the issue. I was looking to see if -- I was looking
8 to see what I had in my filing cabinet Eliot had been
9 giving to me and to store away for him. And since we
10 were going to be talking in anticipation of the
11 conference saying I better pull this out, it was a
12 logistical thing, because I had no idea when we
13 started talking to Joao or whatever what he was - what
14 they were going to be referring to, because there was
15 not - whether it was going to be one patent, two
16 patents, three, if some were modifications or
17 whatever. So I was reviewing to see what I had.

18 Q. Okay. Well, let's go on to the last page,
19 the next page of the bill, I should say.

20 A. Right.

21 Q. Which is page 18.

22 A. Right.

23 Q. And I'm going to direct you to - actually,
24 let's see, there is 5/27/99.

25 A. Right.

KEN SCHANZER & ASSOCIATES, INC. (954) 922-2660



Lorraine Christine Hoffman, Esq.
Assistant Staff Counsel
The Florida Bar
File No. 2003-51, 109(15C)

170

1 Q. It says 1.5, entry for you: Overview of
2 iviewit patent matters and corporate matters?

3 A. Right.

4 Q. What did that entail?

5 A. It would entail sitting down, taking a
6 piece of paper and seeing where we are on each thing;
7 who is doing what on corporate; who is doing -- Now
8 that we've gone to this weekend, now that we've gone
9 to these conferences, now that we see and really
10 giving myself an overview of who is doing what and who
11 is following through and on what patent matters and on
12 what corporate matters. Again, more logistical.

13 Q. I'm sorry, that's -- The only distinction
14 between that and the entry on 5/26 is what?

15 MR. TRIGGS: Object to the form. I think
16 he's testified as to what the entries were. You
17 want him to tell you again?

18 Q. What's the difference in the entry on 5/26
19 which says, review of patents and set up patent
20 conference, and 5/27, overview of patent matters?

21 A. Well, first of all, overview, it's
22 overview of patent matters and corporate matters. So
23 I was looking at -- I mean, a portion of it was the
24 patent matters, but a portion of it was the corporate
25 matters. So it's quite distinguishable on that. And

??

KEN SCHANZER & ASSOCIATES, INC. (954) 922-2660



Lorraine Christine Hoffman, Esq.
Assistant Staff Counsel
The Florida Bar
File No. 2003-51, 109(15C)

171

1 as far as review of the patent, it was actually
2 looking at the real patent documents for the first
3 time to sort them out in anticipation of a conference
4 call we were going to have which resulted from Eliot
5 telling us he had not followed up with Joao in doing
6 the video.

7 And so, I mean, there were a bunch of
8 documents. So it was organizing, putting them
9 together in anticipation of the whole conference.

10 Q. Okay. And 5/28/99, D. Thompson II,
11 conference with D. Thompson it appears, according to
12 that?

13 A. Right. Re: patents and confidentiality
14 agreements?

15 Q. Correct.

16 MR. TRIGGS: What's your question?

17 Q. I don't see an entry for a meeting you had
18 with D. Thompson on that date.

19 A. I probably missed it. We don't always put
20 down our time.

21 Q. So it's a freebee. Is that how that one
22 works?

23 A. I would say that mine is probably subsumed
24 by 5/28, a meeting as to patent issues and management
25 matter.

KEN SCHANZER & ASSOCIATES, INC. (954) 922-2660



Lorraine Christine Hoffman, Esq.
Assistant Staff Counsel
The Florida Bar
File No. 2003-51, 109(15C)

172

1 Q. And how about 5/31, review of patent and
2 other materials?

3 MR. TRIGGS: Again, what's your question?

4 Q. What did that entry entail, if you can
5 recall?

6 A. I don't recall.

7 MR. SELZ: Number six?

8 (Thereupon, said document was marked as
9 Defendant's Exhibit Number 6 for identification
10 by the reporter.)

11 Q. (By Mr. Selz) During the summer, were
12 there any other discussions that you could recall with
13 Ken Rubenstein regarding the patents or the
14 intellectual properties of iviewit?

15 MR. TRIGGS: Object to form. During what
16 period of time?

17 Q. During the period of time that we've
18 discussed for the first bill, which was January 1999
19 through May '99.

20 A. What was the question?

21 Q. Can you recall any other conversations or
22 discussions you had with Ken Rubenstein?

23 A. Other than as reflected in there?

24 Q. Other than as are reflected in these
25 billing statements.

KEN SCHANZER & ASSOCIATES, INC. (954) 922-2660

And later from Wheeler deposition



Lorraine Christine Hoffman, Esq.
Assistant Staff Counsel
The Florida Bar
File No. 2003-51, 109(15C)

176

1 things we had going. It could have been -- At one
2 time, I don't know if - I can't say whether this is
3 the time or not, but there were occasional matters
4 that - that came in that were threatened or whatever.

5 For instance, Jim -- For instance, the
6 person from New Jersey, Armstrong wanted to get his
7 money back or - and so he threatened a lawsuit, and
8 this could have been a response letter or something
9 else like that.

10 From time to time there were peripheral
11 litigation matters. I don't know if any of them
12 blasted into full-fledged lawsuits. I don't recall.

13 Q. Okay. How about on -- Let's see, we've
14 got the ninth page of that billing statement.

15 A. All right.

16 Q. 1/11/2000, 1.0, conference with
17 Mr. Bernstein regarding patents and infringement.

18 That doesn't sound administrative to me. Could you
19 describe what that activity was?

20 MR. TRIGGS: Object to the preface as
21 argumentative.

22 MR. SELZ: I'll retract that.

23 Q. Could you describe for me what that was
24 dealing with, sir?

25 A. I can't remember. But Eliot was disturbed

KEN SCHANZER & ASSOCIATES, INC. (954) 922-2660



Lorraine Christine Hoffman, Esq.
Assistant Staff Counsel
The Florida Bar
File No. 2003-51, 109(15C)

177

1 What did he
2 do about it?
3 Cover it up?

1 that - at times that people may have been trying to
2 steal his patents. So I believe he came in and talked
3 to me about it.

4 Q. And the same day there is another
5 conference with Eliot Bernstein for an hour.

6 A. Right.

7 Q. And a one-hour conference with Mr. Utley.

8 A. Right.

9 Q. And a one-hour conference with Mr. Joao.

10 A. Right.

11 Q. And another one-hour conference with
12 Mr. Thompson and Mrs. Robbins regarding work.

13 A. Right.

14 Q. Whatever that was.

15 A. Right.

16 Q. And another half hour conference with
17 Mr. Lewin regarding patents.

18 A. Right.

19 Q. And then another half hour conference with
20 Mr. Bernstein, Mr. Utley, regarding status of patents
21 and corporate setup.

22 A. Right.

23 Q. And then you've got another entry for 8.75
24 hours -- I'm sorry. That's Robbins. I'm sorry.

25 A. Robbins.

KEN SCHANZER & ASSOCIATES, INC. (954) 922-2660



Lorraine Christine Hoffman, Esq.
Assistant Staff Counsel
The Florida Bar
File No. 2003-51, 109(15C)

178

1 Q. I'm sorry.

2 A. You are going to commend me on working so
3 hard.

4 Q. I was going to say, you got to cut back.
5 So you have - but again, it references --

6 Do you have anything with regard to that - those ones
7 referencing patents, the 1/11/2000 to --

8 A. I don't recall exactly. So - I mean, it
9 would be speculation. I would believe they're all
10 related, to be honest with you.

11 Q. Again, I know you have answered this, but
12 I just want to make sure, you don't have any more
13 comprehensive notes as to the services provided, other
14 than what's contained in these billing statements, is
15 that correct? You don't have a handwritten billing
16 statement that has a more complete description of the
17 services?

18 A. No, no, no.

19 Q. Or you don't have some interim billing
20 statement and then it's produced or redacted or
21 whatever?

22 A. No. Here's the name of the person, Cris
23 Branden was his last name, at Huizenga Holdings --

24 Q. Okay. Thank you.

25 A. -- that we were concerned about.

KEN SCHANZER & ASSOCIATES, INC. (954) 922-2660

And further in his deposition



Lorraine Christine Hoffman, Esq.
Assistant Staff Counsel
The Florida Bar
File No. 2003-51, 109(15C)

181

1 a conference with the two of us or two separate
2 conferences. So, no, I don't recall what it is.

3 Q. How about on January 14th, 2000, it says
4 conference with Mr. Utley and Mr. Rubenstein?

5 A. Uh-huh.

6 Q. Is that Ken Rubenstein?

7 A. Uh-huh.

8 Q. You have to say yes or no for the court
9 reporter.

10 A. Yes. I'm sorry.

11 Q. Do you have any recollection as to what
12 that conference was about?

13 A. No.

14 Q. Was that in person or was that telephonic?

15 A. Telephonic. I mean, Utley was probably
16 with me in person, and Rubenstein was probably on the
17 line.

18 Q. Do you have any recollection at all what
19 you discussed?

20 A. No.

21 Q. And this was past the initial formation
22 phase of the corporation? This was in January of 2000
23 already, is that correct?

24 A. Correct.

25 Q. What was Investech, if you know?

KEN SCHANZER & ASSOCIATES, INC. (954) 922-2660



Lorraine Christine Hoffman, Esq.
Assistant Staff Counsel
The Florida Bar
File No. 2003-51, 109(15C)

182

1 MR. TRIGGS: Point him to a place in the
2 bill.

3 A. That was Huizenga's subsidiary. That was
4 the affiliated company. That was his - that's his
5 high tech affiliate. I believe that's correct.

6 Q. How about - I don't know if you have any
7 information on this, but let me ask it to you. It's
8 on January 14th, 2000, G. Coleman.

9 A. Uh-huh.

10 Q. 3.25 entry. It's a telephone conference
11 with Martha re: private offering memorandum; telephone
12 conference with E. Lewin re: audited financial
13 statements; interoffice conference with R. Thompson.
14 Then it goes, preparation of revisions to intellectual
15 property risk factors.

16 A. Uh-huh.

17 Q. Interoffice conference with C. Wheeler
18 regarding potential intellectual property
19 infringement.

20 A. Uh-huh. She was doing a Private Placement
21 Memorandum, so she was explaining how she was
22 approaching it.

23 Q. Would she prepare some kind of --

24 A. Well, I mean, it says the disclosure.
25 There was a private placement they were putting

KEN SCHANZER & ASSOCIATES, INC. (954) 922-2660



Lorraine Christine Hoffman, Esq.
Assistant Staff Counsel
The Florida Bar
File No. 2003-51, 109(15C)

183

1 together. I don't think the private placement ever
2 came to fruition. I think it was called off. I could
3 be wrong. Maybe the document was used. I'd have to
4 go back and check.

5 Q. When iviewit LLC was dissolved, did you
6 ever make an attempt to get any other signed retainer
7 agreement?

8 A. No.

9 Q. Or signed engagement agreement from any of
10 the other entities?

11 A. No.

12 Q. Was there any particular reason why you
13 didn't?

14 A. No.

15 Q. There's an entry on the next page, page
16 14, 1/17/2000, G. Coleman. I don't know if you've got
17 any information about this. But it says, conference
18 with E. Lewin regarding financial information;
19 telephone conference with K. Rubenstein regarding
20 potential or possible infringement it says.

21 A. Uh-huh.

22 Q. Do you have any information about that at
23 all?

24 A. No.

25 Q. Did you --

KEN SCHANZER & ASSOCIATES, INC. (954) 922-2660

And later in Wheeler deposition



Lorraine Christine Hoffman, Esq.
Assistant Staff Counsel
The Florida Bar
File No. 2003-51, 109(15C)

201

1 of thing.

2 Q. So representation with regard to --

3 A. I'd have to see them exactly to tell you.

4 Q. Now, we talked earlier that there were -
5 there were intellectual properties that were involved,
6 and let's see if I have a billing entry.

7 A. Are we done with this exhibit?

8 Q. Yeah. We are.

9 MR. BERNSTEIN: Steve?

10 MR. SELZ: Yeah.

11 MR. BERNSTEIN: What was that? I missed
12 the last part.

13 MR. SELZ: No, I didn't finish it.

14 MR. BERNSTEIN: Okay.

15 Q. Okay. We started talking about some of
16 these entries. We've got --

17 Okay. I think we already talked about
18 there were some entries here dealing with intellectual
19 property review and incorporation. We went over that.
20 Let's see.

21 Do you know if Ken Rubenstein ever billed
22 on any of the matters or any references that he had
23 for any of the work for iviewit?

24 A. I don't believe he did.

25 Q. Do you know why that would be the case?

KEN SCHANZER & ASSOCIATES, INC. (954) 922-2660



Lorraine Christine Hoffman, Esq.
Assistant Staff Counsel
The Florida Bar
File No. 2003-51, 109(15C)

202

1 A. I think his time was minimal on it, and it
2 was --

3 Q. Back in, let's see, what was this? June
4 of 1999, was - let's see, I'm sorry, January '99 --
5 Here. February of 1999. Was Mr. Rubenstein
6 affiliated or associated with Proskauer Rose? Let's
7 see, which exhibit is that?

8 A. February of 1999?

9 Q. Yes.

10 A. So we started work in January of 1999.

11 Q. Correct.

12 A. I believe so.

13 Q. Let me just double-check my notes. 2/17.
14 There is an entry here, 2/17/99, dealing with
15 telephone call to Mr. Rubenstein regarding patent
16 advice. I think you already said you don't have any
17 specific recollection what was said at that
18 conference, is that correct?

19 A. Right. But -- Right.

20 Q. Does Proskauer Rose maintain any kind of
21 records regarding Internet web site visits in
22 correlation to the billing provided to iviewit? In
23 other words, did you keep any kind of log as to time
24 spent doing - other than the billing statements
25 themselves - any kind of log keeping track of how much

KEN SCHANZER & ASSOCIATES, INC. (954) 922-2660



Lorraine Christine Hoffman, Esq.
Assistant Staff Counsel
The Florida Bar
File No. 2003-51, 109(15C)

203

1 time was spent Internet searching for different
2 aspects of the corporate work?

3 MR. TRIGGS: Object to the form.

4 MR. SELZ: Okay.

5 MR. TRIGGS: I have no idea where you're
6 going with that.

7 MR. SELZ: It's going to the billing.

8 Q. When you were - the billing statements
9 themselves were prepared, was there any kind of
10 separate log kept for Internet time spent or anything
11 dealing with the Internet research that I think is
12 referenced in here as well?

13 MR. TRIGGS: Same objection.

14 A. I don't know of any separate logs. I
15 don't know how they keep the -- The only Internet logs
16 that I know of are -- The only services that we have
17 are Lexis/Nexis, which is a research.

18 Q. Right.

19 A. You're as familiar with how that is kept
20 as I am.

21 Q. Right.

22 A. I honestly don't know the mechanism by
23 which they tie in for their searches on copyright and
24 trademark.

25 Q. Now, with regard to Jay Joao, Ray Joao,

KEN SCHANZER & ASSOCIATES, INC. (954) 922-2660



Lorraine Christine Hoffman, Esq.
Assistant Staff Counsel
The Florida Bar
File No. 2003-51, 109(15C)

204

1 was there ever a time when it was represented that Ray
2 Joao was involved with Proskauer, was involved with
3 Proskauer directly, either as a partner or associate
4 or anything of that nature?

5 A. Not to my knowledge.

6 MR. TRIGGS: Object to form.

7 A. To who?

8 Q. To anyone who attended a board meeting or
9 anything of that nature.

10 A. Not to my knowledge.

11 Q. Do you recall any meetings with
12 Mr. Stanley?

13 A. Jerry Stanley.

14 Q. Yes.

15 A. Yes.

16 Q. And what were those meetings dealing with,
17 if you can recall?

18 A. He was Real 3D. He was the expert from
19 Real 3D.

20 Q. Right. Who came down from Orlando I think
21 you said?

22 A. Right. He had been out - I contacted him
23 when he was out visiting Intel. Real 3D had been part
24 of General Electric. Had been sold to -- I believe it
25 was part of General Dynamics at that time, and so I

KEN SCHANZER & ASSOCIATES, INC. (954) 922-2660



Lorraine Christine Hoffman, Esq.
Assistant Staff Counsel
The Florida Bar
File No. 2003-51, 109(15C)

205

1 contacted him, and he was kind enough on one of his
2 journeys in South Florida to stop and see the product.

3 Q. Okay.

4 A. I explained that.

5 Q. Right. At that point in time, can you
6 recall if all the copyright and trademark protections
7 for Iviewit's products were in place?

8 MR. TRIGGS: Object to form.

9 A. Well, no. Okay. The -- I'm not the right
10 person to ask that question because I wasn't doing the
11 trademark and copyright. But if - but I - I can tell
12 you that I've already said on the record that when we
13 were driving back from the meeting in Orlando --

14 Q. Right. The video product.

15 A. That we discovered that Eliot advised his
16 dad and Jerry Lewin and myself that he had not done
17 anything with Ray Joao on the video.

18 Q. Okay.

19 A. So the answer to your question is, from
20 that standpoint, after that meeting I knew that he had
21 not put anything in place.

22 Q. Okay. How about with regard to any of the
23 other aspects of U.S. products?

24 A. I was not aware.

25 Q. You were checking on the status of the

KEN SCHANZER & ASSOCIATES, INC. (954) 922-2660



Lorraine Christine Hoffman, Esq.
Assistant Staff Counsel
The Florida Bar
File No. 2003-51, 109(15C)

206

1 copyrights and the trademark?

2 MR. TRIGGS: Object to form. As to when?

3 Q. As to when this occurred, back in -- When
4 was it?

5 MR. TRIGGS: What occurred?

6 Q. 4/21/99 or thereabouts. The meeting with
7 Mr. Stanley.

8 A. There were certain times when it's
9 reflected I was checking on the status of copyrights
10 and trademarks.

11 Q. All right. Was there ever a nondisclosure
12 agreement that you're aware of that Mr. Stanley
13 signed?

14 A. Yes. I believe they signed -- My
15 recollection is they signed nondisclosure agreements.
16 They signed confidentiality agreements.

17 Q. Okay. Which is basically, obviously, the
18 same thing, nondisclosure.

19 A. Correct.

20 Q. The business plan itself for iviewit, did
21 that include references to the intellectual properties
22 that iviewit held?

23 A. It depends on what stage you meant the
24 business plan.

25 Q. Okay. The latest iteration of the

KEN SCHANZER & ASSOCIATES, INC. (954) 922-2660



Lorraine Christine Hoffman, Esq.
Assistant Staff Counsel
The Florida Bar
File No. 2003-51, 109(15C)

207

1 business plan that was produced or that you were
2 involved with, did it contain representations
3 concerning intellectual properties?

4 A. We weren't intimately involved in the
5 business plan, so I really don't recall the latest
6 reiteration. No.

7 Q. Do you know if Ken Rubenstein was ever
8 listed as an advisor to the board of directors or an
9 advisor to iviewit in any documents?

10 MR. TRIGGS: Object to the form. By whom?

11 Q. (By Mr. Selz) Do you know if Ken
12 Rubenstein was listed --

13 A. In any documents?

14 Q. -- by iviewit or - in any documents that
15 were submitted to any third parties as an advisor or
16 was represented as an advisor to the board?

17 A. Not - not that I'm aware of.

18 Q. What was the last business plan for
19 iviewit that you can recall seeing?

20 A. Well, I don't recall. I don't -- I
21 actually don't recall the last business plan. I mean,
22 the reason is, everything kept on changing so much.

23 Q. Was there ever any problem with
24 erroneously issued stock or anything of that nature
25 that you're familiar with?

KEN SCHANZER & ASSOCIATES, INC. (954) 922-2660



Lorraine Christine Hoffman, Esq.
Assistant Staff Counsel
The Florida Bar
File No. 2003-51, 109(15C)

208

1 A. I don't - I have no recollection of it.

2 Q. Okay. There's an entry here of 5/12/99
3 just want to reference you to. Conference with Joao;
4 meeting with Thompson to arrange for confidentiality
5 agreements and generic agreements?

6 A. Uh-huh.

7 Q. Do you remember what those generic
8 agreements were?

9 A. Yeah, they were a generic form of a
10 confidentiality agreement so the company could use it
11 without coming back to us each time.

12 Q. So it was basically like a
13 fill-in-the-blank form?

14 A. As much as we could do it. Perhaps.
15 There might have been more than one. There might have
16 been the one that you use in this instance, the one
17 that you use in that.

18 Q. One for a potential investor, one for an
19 employee, one for a different situation than that? Is
20 that what you're referring to?

21 A. Right. Right.

22 Q. Do you recall --

23 A. Well, not exactly an employee. I don't
24 know. There would have been -- My recollection is we
25 were looking at a couple of variations of it for

KEN SCHANZER & ASSOCIATES, INC. (954) 922-2660



Lorraine Christine Hoffman, Esq.
Assistant Staff Counsel
The Florida Bar
File No. 2003-51, 109(15C)

XII. On the errors discovered with the work of Mr. Raymond Joao, the knowledge of Mr. Wheeler as to these errors of his referral and the conflicts associated with your patent attorney having his own patents in your space.

When I View It finally received Mr. Joao's patents we found multiple instances of documents that appear as frauds submitted to; Mr. Wheeler, the US Patent office and Iviewit. You will find missing inventors, switched content in the filed patents vs. what iviewit thought was being filed, and in some instances faxes that are written in January 1999 by Joao and transmitted in January 2000 and even faxes transmitted in March of **1900**.

We submit as evidence Mr. Joao's fax on a very important document submitted to the patent office, under further investigation of the faxes of Mr. Joao including faxes submitted to Mr. Wheeler what one will find is that Mr. Joao's faxes appear to all be unbilled for and fraudulent documents. The reason this fax is important is because it is the Company's contention that this was supposed to be for a second video patent with file number 5865-2 that later becomes lost after review by Proskauer Rose attorney Jill Zamas who also wonders where 5865-2 went. The image patent shown here should have been filed in January 1999 and the video in March of 1999. This has led to the Company being exposed to massive liabilities with the video patents. We have attached the Complaint submitted to the New York State Bar against Raymond Joao as further evidence that Joao worked in collusion with Mr. Wheeler in damaging the Iviewit patents and has since lost or destroyed his records. In the 7/31/00 transcripts [Exhibit E](#) Mr. Wheeler is fully aware that Joao has destroyed records and as counsel does not do a single thing to try and rectify or obtain his documents at that point.



Lorraine Christine Hoffman, Esq.
 Assistant Staff Counsel
 The Florida Bar
 File No. 2003-51, 109(15C)

FROM : 1900-03-10 12:04 #440 P.01/04

 *** TX REPORT ***

TRANSMISSION OK

TX/RX NO 1332
 CONNECTION TEL 15619998810
 SUBADDRESS
 CONNECTION ID
 ST. TIME 03/10 09:28
 USAGE T 01:50
 PGS 5
 RESULT OK

Note fax sent
 3.10.1900

LAW OFFICES
MELTZER, LIPPE, GOLDSTEIN & SCHLISSEL, P.C.

THE CHANCERY
 190 WILLIS AVENUE
 MINEOLA, NEW YORK 11501
 (516) 747-0300

BWDL
3
10.15.0

DATE: March 10, 2000 TIME: 9:29AM
 Telecopier Message From: RAYMOND A. JOAO, ESQ.
 of Meltzer, Lippe, Goldstein & Schlissel, P.C.
 Please deliver the following pages to:

TO:	MR. ELIOT BERNSTEIN
OF:	IVIEWIT
FAX NUMBER:	561-999-8810
NUMBER OF PAGES, INCLUDING THIS COVER PAGE:	5
COMMENTS/INSTRUCTIONS:	
Re: Patent Application Entitled:	APPARATUS AND METHOD FOR PRODUCING ENHANCED DIGITAL IMAGES
Our Ref. No. :	5865-1
Eliot - attached herewith please find the a Declaration, a Small Entity Statement - Independent Inventor and a Small Entity Statement - Small Business Concern.	
Please sign and date the Declaration and Small Entity Statement - Independent Inventor where indicated and have Brian Utley sign the Small Entity Statement - Small Business Concern where indicated and return the signed, dated documents to us via facsimile (516-747-9363) as soon as possible so that we may file the above-indicated patent application in	



Lorraine Christine Hoffman, Esq.
 Assistant Staff Counsel
 The Florida Bar
 File No. 2003-51, 109(15C)

FROM : 1900-03-10 12:04 #448 P.02/04

LAW OFFICES
MELTZER, LIPPE, GOLDSTEIN & SCHLISSEL, P.C.

THE CHANCERY
190 WILLIS AVENUE
MINEOLA, NEW YORK 11501
(516) 747-0300

Note fax sent
 3.10.1900

DATE: March 10, 2000 TIME: 9:29AM
 Telecopier Message From: RAYMOND A. JOAO, ESQ.
 of Meltzer, Lippe, Goldstein & Schlissel, P.C.
 Please deliver the following pages to:

TO:	MR. ELIOT BERNSTEIN
OF:	IVIEWIT
FAX NUMBER:	561-999-8810
NUMBER OF PAGES, INCLUDING THIS COVER PAGE:	5
COMMENTS/INSTRUCTIONS:	
Re: Patent Application Entitled:	APPARATUS AND METHOD FOR PRODUCING ENHANCED DIGITAL IMAGES
Our Ref. No. :	5865-1
Eliot - attached herewith please find the a Declaration, a Small Entity Statement - Independent Inventor and a Small Entity Statement - Small Business Concern.	
Please sign and date the Declaration and Small Entity Statement - Independent Inventor where indicated and have Brian Utley sign the Small Entity Statement - Small Business Concern where indicated and return the signed, dated documents to us via facsimile (516-747-9363) as soon as possible so that we may file the above-indicated patent application in the PTO today.	
If you have any questions, please do not hesitate to contact me.	

Transmitting
 from a Panasonic 733 Digital Facsimile Transceiver. The FAX number is (310) 761-9363. If you do not receive all of the pages, please call us back as soon as possible at (516) 747-0300, extension 247.
 THIS MESSAGE IS INTENDED FOR THE USE OF THE INDIVIDUAL OR ENTITY TO WHICH IT IS ADDRESSED AND MAY CONTAIN INFORMATION THAT IS PRIVILEGED, CONFIDENTIAL AND EXEMPT FROM DISCLOSURE UNDER APPLICABLE LAW. IF THE READER OF THIS MESSAGE IS NOT THE INTENDED RECIPIENT, OR THE EMPLOYEE OR AGENT RESPONSIBLE FOR DELIVERING THE MESSAGE TO THE INTENDED RECIPIENT, YOU ARE HEREBY NOTIFIED THAT ANY DISSEMINATION OR COPYING OF THIS COMMUNICATION IS STRICTLY PROHIBITED. IF YOU HAVE RECEIVED THIS COMMUNICATION IN ERROR, PLEASE NOTIFY US IMMEDIATELY BY TELEPHONE AND RETURN THE ORIGINAL MESSAGE TO US AT THE ABOVE ADDRESS VIA U.S. POSTAL SERVICE. THANK YOU.

205406.1

B3
 10.15.02



Lorraine Christine Hoffman, Esq.
 Assistant Staff Counsel
 The Florida Bar
 File No. 2003-51, 109(15C)

FRONT 1 1900-03-10 12:05 #440 P.03/04

Please type a plus sign (+) inside this box →

PTO/SB/01 (12-97)

Approved for use through 5/20/00. OMB 0031-0032
 Patent and Trademark Office, U.S. DEPARTMENT OF COMMERCE

Under the Paperwork Reduction Act of 1995, no persons are required to respond to a collection of information unless it carries a valid OMB control number.

Note fax sent
 3.10.1900

DECLARATION FOR UTILITY OR DESIGN PATENT APPLICATION (37 CFR 1.63)	Attorney Docket Number <u>5865-1</u>
	First Named Inventor <u>Eliot J. Bernstein</u>
	COMPLETE IF KNOWN
	Application Number <u>/</u>
	Filing Date
	Group Art Unit
<input type="checkbox"/> Declaration Submitted with Initial Filing	<input type="checkbox"/> Declaration Submitted after initial Filing (surcharge (37 CFR 1.16 (e)) required)
Examiner Name	

As a below named inventor, I hereby declare that:

My residence, post office address, and citizenship are as stated below next to my name.

I believe I am the original, first and sole inventor (if only one name is listed below) or an original, first and joint inventor (if plural names are listed below) of the subject matter which is claimed and for which a patent is sought on the invention entitled:

APPARATUS AND METHOD FOR PRODUCING ENHANCED DIGITAL IMAGES

the specification of which *(Title of the invention)*

is attached hereto
 OR
 was filed on (MM/DD/YYYY) _____ as United States Application Number or PCT International Application Number _____ and was amended on (MM/DD/YYYY) _____ (if applicable).

I hereby state that I have reviewed and understood the contents of the above identified specification, including the claims, as amended by any amendment specifically referred to above.

I acknowledge the duty to disclose information which is material to patentability as defined in 37 CFR 1.56.

I hereby claim foreign priority benefits under 35 U.S.C. 119(a), (b) or 365(a) of any foreign application(s) for patent or inventor's certificate, or 365(b) of any PCT international application which designated at least one country other than the United States of America, listed below and have also identified below, by checking the box, any foreign application for patent or inventor's certificate, or any PCT international application having a filing date before that of the application on which priority is claimed.

Prior Foreign Application Number(s)	Country	Foreign Filing Date (MM/DD/YYYY)	Priority Not Claimed	Certified Copy Attached?	
			<input type="checkbox"/>	YES	NO
			<input type="checkbox"/>	<input type="checkbox"/>	<input type="checkbox"/>
			<input type="checkbox"/>	<input type="checkbox"/>	<input type="checkbox"/>

Additional foreign application numbers are listed on a supplemental priority data sheet PTO/SB/02B attached hereto.

I hereby claim the benefits under 35 U.S.C. 119(e) of any United States provisional application(s) listed below.

Application Number(s)	Filing Date (MM/DD/YYYY)
60/125,824	03/24/99

Additional provisional application numbers are listed on a supplemental priority data sheet PTO/SB/02B attached hereto.

(Page 1 of 2)

Briefing Hour Statement: This form is estimated to take 0.4 hours to complete. Time will vary depending upon the needs of the individual case. Any comments on the amount of time you are required to complete this form should be sent to the Chief Information Officer, Patent and Trademark Office, Washington, DC 20231. DO NOT SEND FEES OR COMPLETED FORMS TO THIS ADDRESS. SEND TO: Assistant Commissioner for Patents, Washington DC 20231.

10.15.03



Lorraine Christine Hoffman, Esq.
 Assistant Staff Counsel
 The Florida Bar
 File No. 2003-51, 109(15C)

FD001 :

1900-03-10 12:05 #440 P.04/04

Please type a plus sign (+) inside the box Approved for use (this Patent and Trademark Office, U.S. 28
 Under the Paperwork Reduction Act of 1996, no persons are required to respond to a collection of information unless it displays a valid OMB control number.

Note fax sent
3.10.1900

DECLARATION — Utility or Design Patent Application

I hereby claim the benefit under 35 U.S.C. 120 of any United States application(s), or 365(c) of any PCT International application designating the United States of America, listed below and, insofar as the subject matter of each of the claims of the application is not disclosed in the prior United States or PCT International application in the manner provided by the first paragraph of 35 U.S.C. 112, I acknowledge the duty to disclose information which is material to patentability as defined in 37 CFR 1.56 which became available between the filing date of the prior application and the national or PCT International filing date of the application.

U.S. Parent Application or PCT Parent Number	Parent Filing Date (MM/DD/YYYY)	Parent Patent Number (if applicable)

Additional U.S. or PCT International application numbers are listed on a supplemental priority data sheet (PTO/SB/01) attached hereto.

As a named inventor, I hereby appoint the following registered practitioner(s) to prosecute the application and to transact all business in the Patent and Trademark Office connected therewith:

Customer Number Also Customer Number/Bar Code Label/Doc

Registered practitioner(s) name/registration number listed below

Name	Registration Number	Name	Registration Number
Raymond A. Joao, Esq.	35,907		

Additional registered practitioner(s) named on supplemental Registered Practitioner Information sheet (PTO/SB/02) attached hereto.

Direct all correspondence to: Customer Number OR Correspondence address below

Name: Raymond A. Joao, Esq.,
 Address: Meltzer, Lippe, Goldstein & Schissel, P.C.
 Address: The Chancery, 190 Willis Avenue
 City: Mineola State: NY ZIP: 11501
 Country: USA Telephone: 516-747-0300 Fax: 516-747-9363

I hereby declare that all statements made herein of my own knowledge are true and that all statements made on information and belief are believed to be true; and further that these statements were made with the knowledge that willful false statements and the use so made are punishable by fine or imprisonment, or both, under 18 U.S.C. 1001 and that such willful false statements may jeopardize the validity of the application or any patent issued thereon.

Name of Sole or First Inventor: A petition has been filed for this unnamed inventor

Given Name (first and middle if any): Elior I. Family Name or Surname: BERNSTEIN

Inventor's Signature: *[Signature]* Date: 03/10/00

Residence: City: Boca Raton State: FL Country: USA Citizenship: USA

Post Office Address: 500 S.E. Mizner Blvd., Suite 102
 Post Office Address: Boca Raton, FL 33432-6080
 City: Boca Raton State: FL ZIP: 33432-6080 Country: USA

Additional inventors are being named on the supplemental Additional Inventor(s) sheet(s) (PTO/SB/02A) attached hereto.

+
 03
 10.15.04

[Page 2 of 2]



Lorraine Christine Hoffman, Esq.
Assistant Staff Counsel
The Florida Bar
File No. 2003-51, 109(15C)

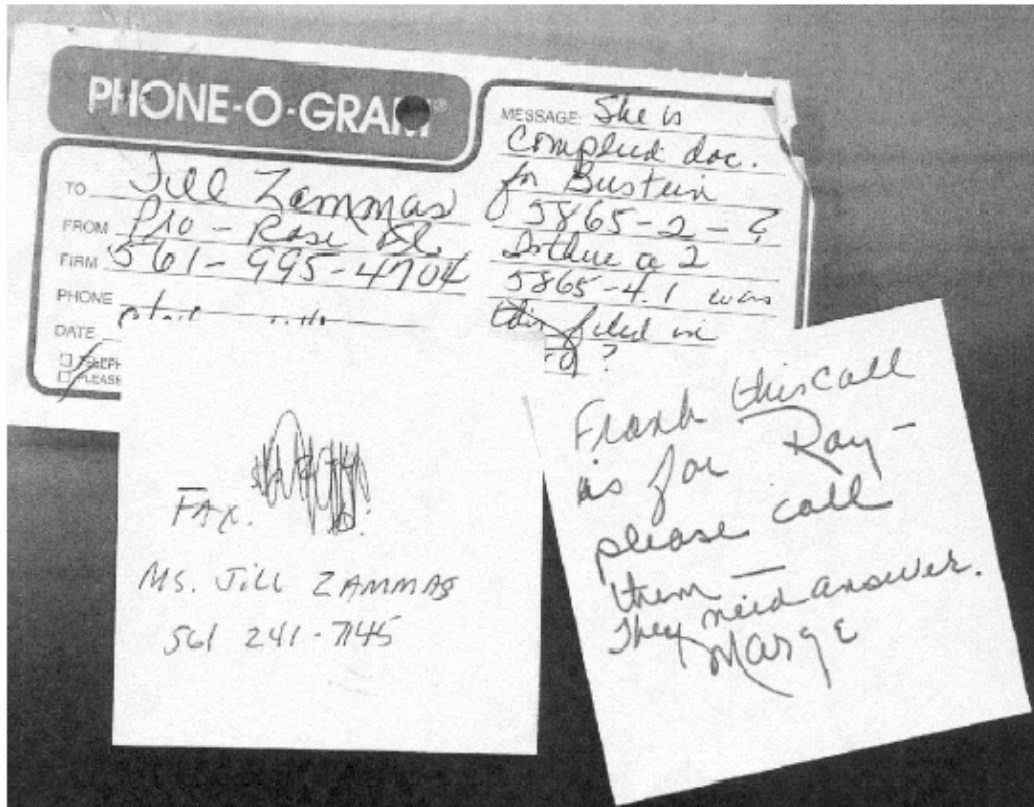

And further regarding Mr. Joao being misrepresented by Mr. Wheeler we find here a letter dated 1/99 regarding the Iviewit patents authored by Mr. Joao who was according to Mr. Wheeler and Mr. Rubenstein not referred to Iviewit until 3/99? The Company does not attest to the validity of this document as we feel it is another forged document mischievously placed in the corporate records by Mr. Utley.



Lorraine Christine Hoffman, Esq.
 Assistant Staff Counsel
 The Florida Bar
 File No. 2003-51, 109(15C)

01/13/00 THU 10:37 FAX ←

001

 *** TX REPORT ***

TRANSMISSION OK

TX/RX NO	0196	
CONNECTION TEL		15619998810
SUBADDRESS		
CONNECTION ID		
ST. TIME	01/13 10:36	
USAGE T	01'10	
PGS.	4	
RESULT	OK	

To: Eliot Bernstein
 From: Ray Joao
 Date: January 12, 1999
 Fax No.: 1-561-999-8810
 No. Pages: 4 (including cover)
 Eliot:



*Gu 26
 BN 3
 26.4*

Please find attached a draft description in response to your request. Please note that any subsequent assignment of the patent applications from Iviewit Holdings, Inc. to yourself would require that we change the description to reflect Iviewit's interests. For, example, if you grant Iviewit an exclusive license with right to sublicense the technology, such a new relationship would have to be included.

Please don't hesitate to contact me if you have any questions.

Ray Joao



Lorraine Christine Hoffman, Esq.
Assistant Staff Counsel
The Florida Bar
File No. 2003-51, 109(15C)

And we submit further evidence that Mr. Joao's work as overseen by Rubenstein/Wheeler had severe problems including filed documents with the patent office that have blanked out dates to hide the facts.



Lorraine Christine Hoffman, Esq.
 Assistant Staff Counsel
 The Florida Bar
 File No. 2003-51, 109(15C)

PFD-105P
 (Rev. 8-95)

**PROVISIONAL APPLICATION
 FILING RECEIPT**



**UNITED STATES DEPARTMENT OF COMMERCE
 Patent and Trademark Office
 ASSISTANT SECRETARY AND COMMISSIONER
 OF PATENTS AND TRADEMARKS
 Washington, D.C. 20231**

APPLICATION NUMBER	FILING DATE	FIL FEE REC'D	ATTORNEY DOCKET NO.	DRWGS
60/137,297	06/03/99	\$75.00	5865-3	0

RAYMOND A JOAO
 MELTZER LIPPE GOLDSTEIN & SCHLISSEL PC
 190 WILLIS AVENUE
 MINEOLA NY 11501

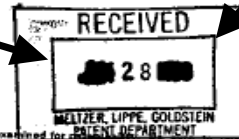

Receipt is acknowledged of this Provisional Application. This Provisional Application will not be examined for patentability. To provide the PROVISIONAL APPLICATION NUMBER, FILING DATE, NAME OF APPLICANT, and TITLE OF INVENTION when inquiring about this application. Fees transmitted by check or draft are subject to collection. Please verify the accuracy of the data presented on this receipt. If an error is noted on this Filing Receipt, please write to Box Provisional Application within 10 days of receipt. Please provide a copy of the Provisional Application Filing Receipt with the changes noted thereon. This Provisional Application will automatically be abandoned twelve (12) months after its filing date and will not be subject to revival to restore it to pending status beyond a date which is after twelve (12) months from its filing date.

Applicant(s) ELIOT BERNSTEIN, BOCA RATON, FL.

IF REQUIRED, FOREIGN FILING LICENSE GRANTED 06/22/99 ** SMALL ENTITY **
 TITLE
 APPARATUS AND METHOD FOR PRODUCING ENHANCED VIDEO IMAGES

DATA ENTRY BY: SMALL, DONNA TEAM: 05 DATE: 06/22/99

(see reverse)



Lorraine Christine Hoffman, Esq.
Assistant Staff Counsel
The Florida Bar
File No. 2003-51, 109(15C)

And we submit from Joao's files the document used to open 5865-2, missing any partners signatures, we submit as evidence that Joao was losing patents and as you will find later, filing patents with very similar content as that learned from Iviewit at this very time period of 1/99-3/99. **IT IS CRITICAL TO NOTE THAT PATENT 5865-2 IS MISSING AND THIS BECOMES SOME KIND OF GENERAL FOLDER?**



Lorraine Christine Hoffman, Esq.
 Assistant Staff Counsel
 The Florida Bar
 File No. 2003-51, 109(15C)

F 33
 9/17

MELTZER, LIPPE, GOLDSTEIN, WOLF & SCHLISSEL, P.C.
 CLIENT/MATTER IN-TAKE FORM

CLIENT #: 5865 MATTER #: 2

W 26
 B.N.M.
 26.32

1. CLIENT LEVEL:

CLIENT NAME: IVIEWIT

CONFLICT SEARCH: List company name, subsidiaries, names of owners, names of partners and other companies owned by client:

1. _____	5. _____	9. _____	13. _____
2. _____	6. _____	10. _____	14. _____
3. _____	7. _____	11. _____	15. _____
4. _____	8. _____	12. _____	16. _____

Indicate with an "A" to whom bills and statements should be directed. Indicate with a "B" to whom other mailings should be directed.

COMPANY NAME: IVIEWIT

COMPANY ADDRESS: 500 S.E. Mizner Road, Suite 102

CITY: Boca Raton STATE: Florida ZIP: 33432

ATTN: Mr. Eliot Bernstein FED. ID #: _____

BUSINESS PHONE: (561) 417-8980 BUSINESS FAX: (561) 417-4470

NATURE OF CLIENT'S BUSINESS (Informative but concise): Internet Services

NAME _____ SOC. SEC. # _____

HOME ADDRESS: _____

CITY: _____ STATE: _____ ZIP: _____

HOME PHONE: () _____ DATE WORK COMMENCED: _____

ORIGINATING ATTORNEY: R.A. Joao BANK INFO: _____

2. MATTER LEVEL:

MATTER NAME: Genl - Correspondence file

CONFLICT SEARCH: List any company name, subsidiaries, names of owners, names of partners and other companies owned by client:

1. _____	4. _____	7. _____	10. _____
2. _____	5. _____	8. _____	11. _____
3. _____	6. _____	9. _____	12. _____

DESCRIBE MATTER (Informative but concise)

GENERAL INTELLECTUAL PROPERTY MATTERS

CLIENT UNBILLED VALUE: _____

PREV. BILLED & UNPAID: _____

CLIENT TOTAL: _____

BILLING ATTORNEY R.A. Joao FEE ARRANGEMENT _____

SPECIAL RATES? YES NO EXPLAIN: _____

UNUSUAL BILLING PROCEDURE? YES NO EXPLAIN: _____

WORK TYPE:

- | | | |
|---|---|--|
| <input type="checkbox"/> (A) ART | <input type="checkbox"/> (EP) ESTATE PLANNING | <input type="checkbox"/> (M) MUNICIPAL |
| <input type="checkbox"/> (AQ) MERGERS & ACQUISITION | <input type="checkbox"/> (G) GENERAL | <input type="checkbox"/> (P) PARTNERSHIP |
| <input type="checkbox"/> (AR) ARBITRATION | <input checked="" type="checkbox"/> (IP) INTELLECTUAL PROPERTY | <input type="checkbox"/> (PT) PATENT |
| <input type="checkbox"/> (BR) BANKRUPTCY | <input type="checkbox"/> (IN) INTERNATIONAL | <input type="checkbox"/> (PL) PRODUCTS LIABILITY |
| <input type="checkbox"/> (CV) CONVERSION, COOP. CONDO | <input type="checkbox"/> (L) LITIGATION | <input type="checkbox"/> (RE) REAL ESTATE |
| <input type="checkbox"/> (CR) CORPORATE - GENERAL | CASE NAME: _____ | <input type="checkbox"/> (RA) RETIREMENT PLAN ADMIN. |
| <input type="checkbox"/> (E) EMPLOYMENT | <input type="checkbox"/> (LA) LABOR | <input type="checkbox"/> (SC) SECURITIES, REG. & COMP. |
| <input type="checkbox"/> (EN) ENVIRONMENTAL | <input type="checkbox"/> (LEG) LEGISLATIVE & REGULATORY AFFAIRS | <input type="checkbox"/> (TX) TAX |
| <input type="checkbox"/> (EA) ESTATE/TRUST ADMIN. | <input type="checkbox"/> (MA) MATRIMONIAL | <input type="checkbox"/> (W) WORKOUT |
| <input type="checkbox"/> (EB) EMPLOYEE BENEFITS/ERISA | | |

REJECTED

IS THERE A WRITTEN RETAINER AGREEMENT? YES NO IF YES, SIGNED BY _____ IF NO, WHY? _____

EXPECTED RETAINER: \$ _____ RECEIVED? YES NO IF YES, DATE REC'D _____

IF NO, WHY? _____

CREDIT LIMIT: \$ _____ APPROVING PARTNER: _____

ATTY REQUESTING FILE TO BE OPENED: R.A. Joao ATTY SIGNATURE: [Signature]

APPROVING PARTNER SIGNATURES: (EITHER LSM, SMG, CG, ASK, OR CAB UNLESS BILLING OR ORIGINATING ATTORNEY)

TWO REQUIRED: 1. _____ 2. _____

DATE: June 3, 1999 SECRETARY OPENING FILE: N. Etisw - Finca

Later becomes Joao's wife →



Lorraine Christine Hoffman, Esq.
Assistant Staff Counsel
The Florida Bar
File No. 2003-51, 109(15C)

And also in question was the late filing of 5865-1 which again the client intake form provided by Meltzer Lippe Goldstein & Schlissel appears to be missing ALL signatures and has only Raymond Joao's name, with no dates and may we remind you this is for a patent filing on file with the US Patent Office which the Company contends is a work of forgery by Mr. Joao, for the bar to review:



Lorraine Christine Hoffman, Esq.
 Assistant Staff Counsel
 The Florida Bar
 File No. 2003-51, 109(15C)

MELTZER, LIPPE, GOLDSTEIN, WOLF & SCHLISSEL, P.C.

CLIENT/MATTER IN-TAKE FORM

CLIENT #: 5865 MATTER #: 1

ev-
178

1. CLIENT LEVEL: CLIENT NAME: IVIEWIT

CONFLICT SEARCH: List company name, subsidiaries, names of owners, names of partners and other companies owned by client:
 1. _____ 5. _____ 9. _____ 13. _____
 2. _____ 6. _____ 10. _____ 14. _____
 3. _____ 7. _____ 11. _____ 15. _____
 4. _____ 8. _____ 12. _____ 16. _____

Indicate with an "A" to whom bills and statements should be directed. Indicate with a "B" to whom other mailings should be directed.
 COMPANY NAME: IVIEWIT
 COMPANY ADDRESS: 506 S.E. Mizner Road, Suite 102
 CITY: Boca Raton STATE: Florida ZIP: 33432
 ATTN: Mr. Eliot Bernstein FED. ID #: _____
 BUSINESS PHONE: (561) 417-8980 BUSINESS FAX: (561) 417-4470
 NATURE OF CLIENT'S BUSINESS (Informative but concise): INTERNET SERVICES

NAME _____ SOC. SEC. # _____
 HOME ADDRESS: _____
 CITY: _____ STATE: _____ ZIP: _____
 HOME PHONE: () _____ DATE WORK COMMENCED: _____
 ORIGINATING ATTORNEY: RAJ BANK INFO: _____

2. MATTER LEVEL: MATTER NAME: _____

CONFLICT SEARCH: List any company name, subsidiaries, names of owners, names of partners and other companies owned by client:
 1. _____ 4. _____ 7. _____ 10. _____
 2. _____ 5. _____ 8. _____ 11. _____
 3. _____ 6. _____ 9. _____ 12. _____

DESCRIBE MATTER (Informative but concise): Provisional patent application
 CLIENT UNBILLED VALUE: _____
 PREV. BILLED & UNPAID: _____
 CLIENT TOTAL: _____

BILLING ATTORNEY _____ FEE ARRANGEMENT _____
 SPECIAL RATES? YES NO EXPLAIN: _____
 UNUSUAL BILLING PROCEDURE? YES NO EXPLAIN: _____

WORK TYPE:
 (A) ART (EP) ESTATE PLANNING (M) MUNICIPAL
 (AQ) MERGERS & ACQUISITION (G) GENERAL (PL) PARTNERSHIP
 (AR) ARBITRATION (IP) INTELLECTUAL PROPERTY (PT) PATENT
 (BR) BANKRUPTCY (IN) INTERNATIONAL (PL) PRODUCTS LIABILITY
 (CV) CONVERSION, COOP. CONDO (L) LITIGATION (RE) REAL ESTATE
 (CR) CORPORATE - GENERAL CASE NAME: _____ (RA) RETIREMENT PLAN ADMIN.
 (E) EMPLOYMENT (LA) LABOR (SC) SECURITIES, REG. & COMP.
 (EN) ENVIRONMENTAL (LEG) LEGISLATIVE & REGULATORY AFFAIRS (TX) TAX
 (EA) ESTATE/TRUST ADMIN. (MA) MATRIMONIAL (W) WORKOUT
 (EB) EMPLOYEE BENEFITS/ERISA

REJECTED

IS THERE A WRITTEN RETAINER AGREEMENT? YES NO IF YES, SIGNED BY _____ IF NO, WHY? _____
 EXPECTED RETAINER: \$ _____ RECEIVED? YES NO IF YES, DATE REC'D _____
 IF NO, WHY? _____
 CREDIT LIMIT: \$ _____ APPROVING PARTNER: _____
 ATTY REQUESTING FILE TO BE OPENED: Raymond A. Joao ATTY SIGNATURE: _____
 APPROVING PARTNER SIGNATURES: (EITHER LSM, SMG, CG, ASK, OR CAB UNLESS BILLING OR ORIGINATING ATTORNEY)
TWO REQUIRED: 1. _____ 2. _____
 DATE: _____ SECRETARY OPENING FILE: _____



Lorraine Christine Hoffman, Esq.
Assistant Staff Counsel
The Florida Bar
File No. 2003-51, 109(15C)

Later after we find that the video and imaging patents were not filed timely, per Christopher Wheeler/Rubenstein, the inventors were then summoned to Mr. Wheeler's offices to re-disclose to Rubenstein and Joao the video processes. In this meeting Mr. Bernstein and Zkirul Shirajee taped the conversation as can be seen in the document and we were unable to locate the tape in the materials provided under court order by Judge Labarga to have everything, and maintain that unless such tape is procured it has been destroyed. The tape contains many statements from the inventors regarding the open cell phone left by Mr. Lewin in the conference room transmitting a very private patent disclosure meeting to unknown listeners. We respectfully ask the Florida bar to attempt to secure the tape left with Mrs. Gloria Burfield, Mr. Wheeler's secretary who can also attest to the events of that day with inventors Bernstein and Shirajee. Mr. Wheeler then had the tape transcribed and it is also missing key information disclosed regarding the process, which he then personally transfers to Mr. Joao. This missing information has again caused massive liability not only in the late filing but the missing content, as well as, the missing inventors. It is interesting to note that Mr. Joao claims never to have known the other inventors, Shirajee and Rosario, although he met with them several times.



Lorraine Christine Hoffman, Esq.
Assistant Staff Counsel
The Florida Bar
File No. 2003-51, 109(15C)

XIII.

We submit as evidence the following materials evidencing Raymond Joao took pertinent information from patent filings shown and developed with the inventors and switched the content with damaging content to the detriment of the Company with the US Patent Office:

What was given to Mr. Joao and typed up by him with the inventors is the first part of this sample. What ends up at the patent office is completely different and severely limits and in fact misses the entire invention. Although the changes may seem minimal, they will probably prevent Iviewit from getting their patents if not corrected. We urge the Florida bar to have a patent expert review these and many others (available upon request) errors and consult with the USPTO to see what corrective actions can be taken when your patent attorney submits fraudulent patents for his clients after being fully aware of the disclosures and inventors:

This is what we told him:



Lorraine Christine Hoffman, Esq.
Assistant Staff Counsel
The Florida Bar
File No. 2003-51, 109(15C)

SUMMARY OF THE INVENTION

The present invention provides an apparatus and a method for producing digital images which overcomes the shortcomings of the prior art. The apparatus includes a camera, which can be a conventional print film camera, digital camera and/or digital developing device, which can be any device or collection of devices for developing the image taken by the camera, into an enlarged print film image or a digital image, and an enlarging device, for enlarging the image. A digital camera can also be utilized to obtain the image. If the image is taken with a digital camera, a print image may be obtained from the digital image. The image can then be enlarged. The image may be enlarged without the need for a print set.

The apparatus also includes a computer and associated peripheral devices for performing the various processing routines of the method of the present invention. The apparatus also includes a scanning device, for scanning the print film image or photograph in order to obtain a digital image representation of same.

The print or digital film image, which is obtained by the camera, can be developed by the developing device, and enlarged by the enlarger. The image print may then be scanned by the scanner in order to generate a digital file or other high quality image extension file. A plurality of these digital files can then be stitched together thereby creating a panoramic scene or image.



Lorraine Christine Hoffman, Esq.
Assistant Staff Counsel
The Florida Bar
File No. 2003-51, 109(15C)

The computer may be utilized in order to perform touch-up operations on the obtained image or image collection in order to make refinements and/or enhancements thereto. The image can then be converted from a high resolution image compression extension file to a low resolution graphic or video image extension file.

The resulting file may then be processed so that the image represented therein can be displayed and/or posted for display to a host computer or other suitable device.

The above process can be repeated using different photo depths for any of the obtained images, or portions thereof, in order to create areas of higher resolution for closer inspections of these areas at different image depths.

Accordingly, it is an object of the present invention to provide an apparatus and a method for providing enhanced digital images from print or digital images.

It is another object of the present invention to provide an apparatus and a method for producing digital images, from images, which have improved and enhanced resolution.

It is still another object of the present invention to provide an apparatus and a method for producing digital images, from print film images, which are suitable for display and/or downloading to a digital computer, a television, a telecommunications environment, and/or any other communications environment.



Lorraine Christine Hoffman, Esq.
Assistant Staff Counsel
The Florida Bar
File No. 2003-51, 109(15C)

It is still another object of the present invention to provide an apparatus and a method for providing a digital image which is characterized by effective image compression subsequent to a stitching operation, thereby avoiding any dramatic loss in image quality.

It is another object of the present invention to provide an apparatus and a method for providing a digital image which dispenses with the need to compress the image data.

It is yet another object of the present invention to provide an apparatus and a method for producing digital images which are characterized by high definition resolution, and which are suitable for high definition television, Web television and large, full screen, panoramic internet applications, without loss of resolution upon image magnification or reduction.

It is another object of the present invention to provide an apparatus and a method for producing and transmitting digital images in a network environment which dispenses with the need for plug-in software.

It is still another object of the present invention to provide an apparatus and a method for producing digital images which facilitates high speed file transfer in a network environment and/or in a computer environment.



Lorraine Christine Hoffman, Esq.
Assistant Staff Counsel
The Florida Bar
File No. 2003-51, 109(15C)

Other objects and advantages of the present invention will be apparent to those skilled in the art upon a review of the Description of the Preferred Embodiment taken in conjunction with the Drawings which follow.

What Mr. Joao the same day files with the US Patent office, instead of what was disclosed to him follows. Note that all references to digital images and devices have been reduced to print film images and numerous other removals of vital content:

Attorney Docket No. 5865-10

5 APPARATUS AND METHOD FOR PRODUCING
ENHANCED DIGITAL IMAGES

FIELD OF THE INVENTION

10 The present invention is directed to an apparatus and a method for producing enhanced digital images and, in particular, to an apparatus and a method for producing enhanced resolution digital images from a print film image.

Way different then above!



Lorraine Christine Hoffman, Esq.
Assistant Staff Counsel
The Florida Bar
File No. 2003-51, 109(15C)

Limits to print vs. above example, no digital images all print film!!!!

SUMMARY OF THE INVENTION

The present invention provides an apparatus and a method for producing digital images which overcomes the shortcomings of the prior art. The apparatus includes a camera, which can be a conventional print film camera, a developing device, which can be any device or collection of
5 devices for developing the image taken by the camera, into a print film image, and an enlarging device, for enlarging the print film image. A digital camera can also be utilized to obtain the image. If the image is taken with a digital camera, a print image is obtained from the digital image. The print image can then be enlarged.

The apparatus also includes a computer and associated peripheral devices for performing the
10 various processing routines of the method of the present invention. The apparatus also includes a scanning device, for scanning the print film image or photograph in order to obtain a digital image representation of same.

The print film image, which is obtained by the camera, can be developed by the developing device, and enlarged by the enlarger. The image print may then be scanned by the scanner in order
15 to generate a digital file or other high quality image extension file. A plurality of these digital files can then be stitched together thereby creating a panoramic scene or image.

The computer may be utilized in order to perform touch-up operations on the obtained image or image collection in order to make refinements and/or enhancements thereto. The image can then be converted from a high resolution image compression extension file to a low resolution graphic
20 or video image extension file.

The resulting file may then be processed so that the image represented therein can be displayed and/or posted for display to a host computer or other suitable device.

The above process can be repeated using different photo depths for any of the obtained images, or portions thereof, in order to create areas of higher resolution for closer inspections of
25 these areas at different image depths.



Lorraine Christine Hoffman, Esq.
Assistant Staff Counsel
The Florida Bar
File No. 2003-51, 109(15C)

???

Accordingly, it is an object of the present invention to provide an apparatus and a method for providing enhanced digital images from print film images.

It is another object of the present invention to provide an apparatus and a method for producing digital images, from print film images, which have improved and enhanced resolution.

5 It is still another object of the present invention to provide an apparatus and a method for producing digital images, from print film images, which are suitable for display and/or downloading in a digital computer and/or in a telecommunications environment.

10 It is still another object of the present invention to provide an apparatus and a method for providing a digital image which is characterized by effective image compression subsequent to a stitching operation, thereby avoiding any dramatic loss in image quality.

It is yet another object of the present invention to provide an apparatus and a method for producing digital images which are characterized by high definition resolution, and which are suitable for high definition television, Web television and large, full screen, panoramic internet applications, without loss of resolution upon image magnification or reduction.

15 It is another object of the present invention to provide an apparatus and a method for producing and transmitting digital images in a network environment which dispenses with the need for plug-in software.

20 It is still another object of the present invention to provide an apparatus and a method for producing digital images which facilitates high speed file transfer in a network environment and/or in a computer environment.

Other objects and advantages of the present invention will be apparent to those skilled in the art upon a review of the Description of the Preferred Embodiment taken in conjunction with the Drawings which follow.

25

205806.1

4



Lorraine Christine Hoffman, Esq.
Assistant Staff Counsel
The Florida Bar
File No. 2003-51, 109(15C)

To one skilled in the art this above example will become apparent as fraud!



Lorraine Christine Hoffman, Esq.
Assistant Staff Counsel
The Florida Bar
File No. 2003-51, 109(15C)

We now submit another instance of malfeasance between Mr. Wheeler and Mr. Joao whereby Mr. Wheeler submits to Mr. Joao the video patent process and remember in his deposition statements Wheeler claims he is unaware of ANY video processes by Iviewit, the following evidence is directly in contradiction to those statements and represents another instance of perjury. Of note is that this process is incorrect and completely removes the step of scaling the video, which is the key step of the process. Mr. Wheeler has transcribed such process from disclosures at his office with the inventors, Mr. Joao and Mr. Rubenstein.

From Wheeler's deposition we submit first:



Lorraine Christine Hoffman, Esq.
Assistant Staff Counsel
The Florida Bar
File No. 2003-51, 109(15C)

1 doing nothing more than harassing at this point.

2 MR. SELZ: Well, with all due respect to
3 your objection, obviously, speaking objections
4 aren't appropriate, certainly in a deposition,
5 but with regard to that, I think it's actually
6 something that's referenced in Mr. Wheeler's own
7 letter.

8 So I think I certainly have an ability to
9 inquire as to what this process was that he was
10 referencing.

11 MR. TRIGGS: You're wasting time, is what
12 you're doing.

13 MR. SELZ: Well, you're certainly entitled
14 to your opinion.

15 Q. Okay. Now, with regard to this image, was
16 there something also, pan and zoom, or something of
17 that nature, that was demonstrated to you?

18 A. I'm not familiar with that.

19 Q. How about something called -- I'm sorry.

20 A. It wasn't demonstrated at all at this
21 stage.

22 Q. I'm talking about at any time during your
23 representation of iviewit?

24 A. Okay. I'm not familiar with the terms,
25 pan and zoom.

Did he say that????

KEN SCHANZER & ASSOCIATES, INC. (954) 922-2660



Lorraine Christine Hoffman, Esq.
Assistant Staff Counsel
The Florida Bar
File No. 2003-51, 109(15C)

1 Q. How about - how about full-screen video?

2 MR. TRIGGS: Object to form. What about
3 full screen video?

4 Q. Are you familiar with the term?

Contradicts himself on this
throughout rest of deposition.
Says later he was familiar.

5 A. Not in any technical sense.

6 Q. Okay. It isn't in your opinion or your
7 knowledge any way related to the process that

8 Mr. Bernstein was involved with?

9 MR. TRIGGS: Object to the form,
10 foundation.

11 A. The process was larger pictures than
12 available on - presently available on the Internet, as
13 I understood it.

14 Q. So it was basically an enlargement of a
15 picture without pixilation. That was your
16 understanding of the process.

17 A. Right.

18 Q. That you referred to in your letter.

19 A. Correct.

20 Q. Was there any other technology that you
21 were aware of that iviewit had developed?

22 A. No.

23 Q. Were there any specific applications that
24 were discussed between iviewit and yourself in the
25 sense of the purpose of these corporations?

KEN SCHANZER & ASSOCIATES, INC. (954) 922-2660



Lorraine Christine Hoffman, Esq.
Assistant Staff Counsel
The Florida Bar
File No. 2003-51, 109(15C)

And now regarding full knowledge of the video invention:

205

1 contacted him, and he was kind enough on one of his
2 journeys in South Florida to stop and see the product.

3 Q. Okay.

4 A. I explained that.

5 Q. Right. At that point in time, can you
6 recall if all the copyright and trademark protections
7 for Iviewit's products were in place?

8 MR. TRIGGS: Object to form.

9 A. Well, no. Okay. The -- I'm not the right
10 person to ask that question because I wasn't doing the
11 trademark and copyright. But if - but I - I can tell
12 you that I've already said on the record that when we
13 were driving back from the meeting in Orlando --

14 Q. Right. The video product.

15 A. That we discovered that Eliot advised his
16 dad and Jerry Lewin and myself that he had not done
17 anything with Ray Joao on the video.

18 Q. Okay.

19 A. So the answer to your question is, from
20 that standpoint, after that meeting I knew that he had
21 not put anything in place.

22 Q. Okay. How about with regard to any of the
23 other aspects of U.S. products?

24 A. I was not aware.

25 Q. You were checking on the status of the

KEN SCHANZER & ASSOCIATES, INC. (954) 922-2660



Lorraine Christine Hoffman, Esq.
Assistant Staff Counsel
The Florida Bar
File No. 2003-51, 109(15C)

And then from a letter sent by Mr. Wheeler to Mr. Joao with the video process for full-screen video:



Lorraine Christine Hoffman, Esq.
 Assistant Staff Counsel
 The Florida Bar
 File No. 2003-51, 109(15C)

PROSKAUER ROSE LLP

2255 Gades Road
 Suite 340 West
 Boca Raton, FL 33431-7380
 Telephone 561.241.7400
 Telefax 561.241.7400
 Fax 561.241.7145

NEW YORK
 LOS ANGELES
 WASHINGTON DC
 CHICAGO
 PHOENIX

PERSONAL AND CONFIDENTIAL

Fax Transmittal

Date June 1, 1999	Client-Matter 0894/40017/001	Sender's Room Number
Total Pages (including Cover) 2		Main Fax Operator 561.241.7400
From Christopher C. Wheeler		Fax No. 516.747.9363
Sender's Voice Number 561.995.4702		Voice No. 516.747.0300.x240
To Ray Joao		
Company Meltzer, Lippe		

Message

The attached is from Eliot Bernstein.

*EB
561-417-4470*

*20 25
B.N.I
35.00*

Confidentiality Note: This message is confidential and intended only for the use of the addressee(s) named above. It may contain legally privileged material. Dissemination, distribution or copying of this message, other than by such addressee(s), is strictly prohibited. If you have received this message in error, please immediately notify us by telephone and return the original to us at the address above. We will reimburse you for the cost of the telephone call and postage. Thank you.

0894/40017-001 BRLIB 1/23 1297 v1

06/01/99 01:07 PM (27:3)



Lorraine Christine Hoffman, Esq.
 Assistant Staff Counsel
 The Florida Bar
 File No. 2003-51, 109(15C)

PATENT FOR VIDEO TECHNOLOGY

Step 1. Is to record the video under any format, beta, VHS, digital, any of the standard file formats. *VHS camera, first camera used to record, live video.*

Step 2. After the video is shot, the second step is to capture the video using any capture device and capture software. *Adobe Premier ~~5~~ Version 5.1 or Final Cut Studio 5.1*

Step 3. Is to edit the video, if necessary, using any standard video editing tools. *Final Cut Studio Version 5.1*

Step 4. Is to convert to real video format. *Real 8.0*

Step 5. Then we manually set the size of the video within the HTML code to 640 by 480. *Frame Resolution of 640 x 480*

Step 6. We then post to the Web using any Web FTP software. *WS FTP 9.25*

Step 7. We then write an Ascii file that calls the real video to stream. This makes it a streaming real at full screen with very good clarity and quality. Under Step 7 we write a separate script saved as our *.rm (star.rm) file that will call the original real video file. This script is included in the HTML codes. For MPEG videos, we follow Steps 1 through 3 the same, then we, in Step 4, convert, if not already, to the MPEG format. 5, insert the video in the HTML codes and expand to 640 by 480. Then we upload the video file to the Web in Step 6. Step 7, this MPEG file is played from the Web by first downloading a small portion of the file and played through the necessary player or any player, actually, that supports AVI, MPEG-type video formats. *9:00 x 6:00 10:20-2:00 1:00-1:20 1:00-1:20*

This tape was recorded on 6/1/99 at the law firm of Proskauer Rose LLP.

When it was discovered that Raymond Joao was not filing timely patents and completely failing to file other inventions, Ken Rubenstein was contacted by Mr. Wheeler who advised the Board and investors that after review of the patents there may have been some errors but that everything was OK and that Ray Joao was leaving MLGS and that he and Brian Utley had an excellent referral a Mr. Bill Dick of F&L. Please refer to the transcripts of the Foley & Lardner meetings attached that show Mr. Wheeler opining on the validity of the patent work done by Joao (contrary to his statements that he knows nothing regarding the patents) and further supporting the contention that problems existed in the filings by Joao and overseen by Rubenstein, that exposed the company to massive liabilities. Foley and Lardner then proclaimed that they could possibly fix the errors, although they could not guarantee such statements. Mr. Wheeler attended these meetings after consulting with Mr. Rubenstein and you will read his claims again that everything is OK and that Raymond Joao's work is flawed. Raymond Joao subsequent to I View It and even during his retained period filed in excess of 50 patents, some which now appear directly related to ideas he learned from iviewit inventors.

We submit the following as evidence that Mr. Wheeler had far more knowledge of the patent materials than he claims under deposition and in fact was acting in the capacity of opining on critical patent matters although he is not a registered patent agent, in a meeting regarding the problems he and Mr. Utley claim to be unaware of in Mr. Joao's work:



Lorraine Christine Hoffman, Esq.
Assistant Staff Counsel
The Florida Bar
File No. 2003-51, 109(15C)

First from Wheeler's deposition:

17 Q. Do you do any work advising clients with
18 regard to patents or patent rights?
19 A. No. Only directing them to the -- When
20 they come in, when our corporate clients come in, we
21 direct them to the proper people.
22 Q. Now, when you say the proper people, you
23 mean the proper people within Proskauer Rose?
24 A. Sometimes.
25 Q. And if a client came in with an

And further



Lorraine Christine Hoffman, Esq.
Assistant Staff Counsel
The Florida Bar
File No. 2003-51, 109(15C)

2 MR. SELZ: Well, with all due respect to
3 your objection, obviously, speaking objections
4 aren't appropriate, certainly in a deposition,
5 but with regard to that, I think it's actually
6 something that's referenced in Mr. Wheeler's own
7 letter.

8 So I think I certainly have an ability to
9 inquire as to what this process was that he was
10 referencing.

11 MR. TRIGGS: You're wasting time, is what
12 you're doing.

13 MR. SELZ: Well, you're certainly entitled
14 to your opinion.

15 Q. Okay. Now, with regard to this image, was
16 there something also, pan and zoom, or something of
17 that nature, that was demonstrated to you?

18 A. I'm not familiar with that.

19 Q. How about something called -- I'm sorry.

20 A. It wasn't demonstrated at all at this
21 stage.

22 Q. I'm talking about at any time during your
23 representation of iviewit?

24 A. Okay. I'm not familiar with the terms,
25 pan and zoom.

KEN SCHANZER & ASSOCIATES, INC. (954) 922-2660

Now from a taped conversation with members of Foley & Lardner, Brian Utley, Christopher Wheeler (representing the work done by Joao/Rubenstein, Maurice Buchsbaum and Eliot Bernstein.



Lorraine Christine Hoffman, Esq.
Assistant Staff Counsel
The Florida Bar
File No. 2003-51, 109(15C)

Transcription of Telephone Conference
Conducted July 31, 2000

Participants:

Eliot Bernstein, Maurice Buchsbaum,
Brian Utley, Doug Boehm, Chris Wheeler
Docket 57103-120

Note: *Square brackets [] are used to indicate inaudible or indecipherable text. Text found inside brackets indicates transcriptionist's best guess. Since speaker names are not specifically identified, transcriptionist has made an attempt to identify based upon comments made in conversation but cannot guarantee that each speaker has been accurately identified. Note also that this recording has numerous instances of participants speaking at once or carrying on simultaneous side conversations that make it difficult to follow and transcribe the entire line of discussion.*

Utley: <begins midstream>...status of the original digital image filings, and basically the fact that the original filings do not cover the full subject matter of the imaging technology; and to wit, one of the missions, in particular in reading the claims section of the provisional and the formal filing, relates to the zooming and panning capability that is inherent in the technology. This has become a topic due to the fact that we are currently in the second phase of filing imaging patent protection which is driven by the provisions that were filed late in last year, between August and December of last year. So the concern that were expressed by Eliot in reviewing this is that this omission of the zooming and panning capability was attributable to a failure, for whatever reason, on the part of Ray [Joa?], the patent attorney of record, in constructing <tape cuts out here>...that are important to moving ahead. The first is: "Given that the filings are what they are, and given what we know about the filing which is scheduled to take place this week on Wednesday, what means do we have to correct the situation; and given



Lorraine Christine Hoffman, Esq.
Assistant Staff Counsel
The Florida Bar
File No. 2003-51, 109(15C)

whatever corrections we find, what then is the big [backdoor] exposure to iviewit based upon what actions we can take. Then, lastly, what, if any, recourse might iviewit have vi sa vi the omissions in the original Are there any other issues, Doug?

Bernstein: Yeah, just correcting back to Ray [Joa?]'s work of the formal filing that he filed. Do we have a copy of that?

Utley: I think you have it.

Bernstein: I don't. I've got the provisional and I've got...

Utley: ...the formal.

Bernstein: This one?

Utley: Yes, that's the formal.

Bernstein: Okay.

Wheeler: I just have one question. Does anybody have, or are we allowed to get, the files of Ray [Joa]?

Boehm: I have them.

Wheeler: Do you have all of the work that he had?

Bernstein: No, not all of it.

Wheeler: What was purported to be in the files?

Bernstein:  And he also claimed to us that he destroyed part of his files.

Boehm: And I have some of his files. I have what was purported to be all of his important files.

<Inaudible comment.>

Utley: Well, there's a whole history, then, because I tried to get complete copies of the files originally, and found out later that not only did he not send us all the files, he didn't mention



Lorraine Christine Hoffman, Esq.
 Assistant Staff Counsel
 The Florida Bar
 File No. 2003-51, 109(15C)

that there was an extra filing out there that we
 didn't even know about.

Bernstein: This one that's in question.

Wheeler: You have no notes, no data on...?

Utley: No, I have the application. I have things that you could get from the patent office—that I had to get from the patent office. I have very few notes. I do have some scribbled Ray [Joa's?] notes, but I think you gave me those notes.

Wheeler: I did. I gave you [] the notes that I had.

Bernstein: And Ray's made disclosures to us that he destroyed the documents to protect us, which I don't know what he was thinking.

Utley: Destroyed what documents?

Bernstein: Whatever he had in his files. Other patent copies, copies of the drafts as they proceeded...all that he destroyed to protect us from something I asked him to explain, and his reasoning...because I said to him, you know, usually you destroy documents when you are protecting somebody from something illegal or something. Have I done something that would force you to hurt me possibly? He said it was typical, normal, that all lawyers destroy their records.

Wheeler fully aware that documents were destroyed and yet he does nothing about it. Cover up.

Wheeler: If that, in fact, is the case—I've never heard of a lawyer that's a victim—<laughter> the work is ours. My wife says when we pay for a lawyer and we pay for the work, the work is ours.

Boehm: The product is yours. You may get copies of his files and everything; but his confidential notes to himself are not necessarily yours. But the word "product"...

Wheeler: You say that anything germane to the issue belongs to him?

Boehm: Well, I mean if he wrote notes...in sidebars...yeah.



Lorraine Christine Hoffman, Esq.
Assistant Staff Counsel
The Florida Bar
File No. 2003-51, 109(15C)

Bernstein: How about revised []. How about copies?

Wheeler: But things which would reinforce your patent, obviously, that is germane to the spec, that you can, yes, you would be entitled to copies.

Bernstein: He's claiming he [] his notes. He destroyed all faxes.

Wheeler: Can I ask you a question?

Bernstein: Yes.

Wheeler: Just so both of us understand...was this patent done prior to his flying down here, or was this patent done as a result of his flying down here and having discussions with you? I was under the impression that when he flew down here--this was before Brian came--I was under the impression that followed our meeting with Reel 3-D. I was under the impression that he was coming down to discuss, at the very least, the video aspect so that you could complete that; but were you also completing the imaging package?

Bernstein: Correct.

Wheeler: So he went to your [kitchen]?

Bernstein: Right.

Wheeler: And the two of you spent all the days...

Bernstein: That's right.

Wheeler: And did he, in front of you, write notes?

Bernstein: Some.

Wheeler: And did he then produce them on his computer and talk about certain things?

Bernstein: Yes.



Lorraine Christine Hoffman, Esq.
Assistant Staff Counsel
The Florida Bar
File No. 2003-51, 109(15C)

Wheeler: I was under the impression he was doing that with you.

Bernstein: He did.

Wheeler: And did you read those?

Bernstein: I did. I did []. But going to that same nature, I think that's the provisional I think we're talking about...

Wheeler: Right.

Bernstein: But he flew out here again with me and Brian and went through this as he went to file this--this is a 3/23/2000 file--that also failed to make mention of.

Wheeler: So that's the formal file...the formal one?

Bernstein: The formal file. So Beau also missed the point.

Wheeler: I just wanted to know and to put things in proportion, when you read the provisionals, because Brian wasn't with the company then, and when there were all those drafts, because obviously we didn't receive them...

Bernstein: Well, you saw that we gave you the documents. I'd get a document from Ray and bring it to you so you would have records of everything up to that point because I didn't want to keep them at my house.

Wheeler: The final...the final...but I'm not reviewing the patent. I was keeping and maintaining the...

Bernstein: Okay, so you have every record...

Wheeler: Every meeting that we maintain. We don't...

Boehm: Any notes that could be produced...

Wheeler: We don't throw away anything.

Bernstein: Yeah, I know.



Lorraine Christine Hoffman, Esq.
Assistant Staff Counsel
The Florida Bar
File No. 2003-51, 109(15C)

Buchsbaum: I know you don't You're very thorough.

Wheeler: So, I'd file it away; so if you gave it to me, it's in our archives.

Bernstein: Right.

Wheeler: I wanted to know, when you read those drafts...

Bernstein: Oh, it was...

Wheeler: Answer my question...when you read the drafts, did you see the panning and scanning elements?

Bernstein: Yeah, and zooming, up to 1,000 times we thought it was. That was the big...you know, we got that in there...as a matter of fact, he just said it...somewhere it's in there up to 1,000 times, isn't it?

Utley: 1,700.

Bernstein: Right. That was our old mistaken a number of times. So, yeah, for him to miss that, Chris, would be the essence of stupidity.

Wheeler: So it was in there?

Bernstein: Absolutely.

Utley: The zooming, it was in the body, but not in the claim.

Boehm: But a provisional doesn't really...doesn't have to have claims.

Wheeler: It doesn't have claims.

Bernstein: But then in our claims of our patent, it's not there. This is what you're representing, Brian.

Wheeler: So you're saying that it wasn't put in the file, but it was put in the provisional.

Boehm: No, I could see where he's going to argue that it's there.



Lorraine Christine Hoffman, Esq.
Assistant Staff Counsel
The Florida Bar
File No. 2003-51, 109(15C)

Bernstein: Let's see. Let's take a look.

Wheeler: ...what the language of the patent claims are that he filed.

Bernstein: Okay, let's see what he...

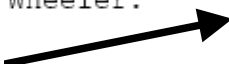
Wheeler:  And this isn't the final decision because I can go back right now and amend those claims.

Bernstein: Wow, yes, but we have elements of exposure that creep in.

Wheeler: I'm just telling you the whole thing, then we'll go back. So you did look it over, and there are no claims in the provisional?

Boehm: There are no claims in a provisional. You can file them, but they are never examined.

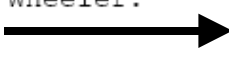
Wheeler:  But the zooming and the panning and the scanning element was incorporated in that?

Boehm: Go ahead, Brian.

Utley: Let me make sure that we say that properly. The provisional filing had a claims section which migrated into the final filing, but Eliot is correct in saying that the provisional does not need a claims section. The provisional never gets examined, so it doesn't need the claims. It just holds your place in line for one year.

Bernstein: But then when I look through this...

Wheeler: Hold on, Eliot, I need to understand this. What you're saying, then, is assuming any negligence on his point, at that point the negligence doesn't become realistically damaging to the company until he actually made a claim...until he actually made a provisional filing. This took our place in line.

Boehm: If the provisional filing covered the invention, your place in line is only as good as the subject matter described in accordance with the law.



Lorraine Christine Hoffman, Esq.
Assistant Staff Counsel
The Florida Bar
File No. 2003-51, 109(15C)

Utley: Obviously, it should have had the panning and zooming in there.

Boehm: Well, the word "zoom" is in there.

Bernstein: But not really to describe what we're doing.

Wheeler: But do you see what I'm saying? It's only to the amount of subject matter and attested where the average person skilled in the art could make and use an invention as it's described in this document, and without "undue" experimentation, without inventing it himself.

→
Wheeler as
patent counsel!

Utley: Right.

Wheeler: Now, this provisional application, you throw it...different patent attorneys do different things with it. On one end of the spectrum, you do an invention disclosure. Most big corporations have invention disclosure form which leads the inventor to write out good disclosures and figures and things, and I've seen people actually file that invention disclosure because if you're coming up on a bar date, you don't have time to write an application or think about what your invention is. All you've got to do is get something on file, and then hope that it will protect...that whatever you had on file covered your invention.

Boehm: Is that what we've done so far?

Bernstein: No.

Wheeler: I don't want to answer that, but that's the line.

Boehm: It's a grey question, it's a grey area, I think.

Utley: That's what we're aiming to do, that's what we're hoping to do.

Wheeler: But on one end of the spectrum, you file very minimal work, and that's what Ray did on some of the applications, like on the one...



Lorraine Christine Hoffman, Esq.
Assistant Staff Counsel
The Florida Bar
File No. 2003-51, 109(15C)

Boehm: He was trying to do it in a broad...

Wheeler: He did say thing conceptually that his method was to do a broad stroke of it.

Boehm: Right. Well, a broad stroke on drafting the claims.

Wheeler: Okay. Right.

Boehm: That doesn't happen in a provisional at all, generally. If you want to, you can write the provisional claims just so you know what you're doing, and it's actually used as subject matter; but the claims are never examined. It doesn't matter if it's in proper format or anything, it just sits there. Now, if you pick up the provisional a year later—it has to be within that year—if it's a real well-done application, you just file it. There's no money involved in turning the provisional into a regular filing. Oftentimes, with these one-page disclosures, there's a substantial amount of money involved in taking that from there to there. The problem is you cannot add subject matter to the patent application later on once it's filed.

Bernstein: Unless it's really the patent application, correct?

Boehm: No, the subject matter has to be supported—has to be described—

Wheeler: As provisional.

Boehm: To that text, or you lose your filing date.

Wheeler: But the zooming element, then, is not in addition. You can't add subject matter. So if he did describe zooming, then it's not in addition.

→

Bernstein: Did he, Doug?

Boehm: I'm not clear on what you mean. You can't add additional subject matter after the filing date



Lorraine Christine Hoffman, Esq.
Assistant Staff Counsel
The Florida Bar
File No. 2003-51, 109(15C)

of an application or you'll lose the right to that filing date.

Wheeler: → The provisional. You can't add subject matter to the provisional.

Boehm: To any application...any patent.

Wheeler: → But if he did describe the zooming, then the zooming element is not an addition in the formal.

Boehm: Right. It's supported. If he described it in the original, you can base claims on it later.

Wheeler: And have we said that the zooming is in the provisional?

Bernstein: Nowhere that I can see.

Buchsbaum: Wait. You're the lawyer reading another lawyer's work. Is it in there?

Boehm: Do you have a copy of it?

Bernstein: Yeah, right here. It isn't in there if it bites you.

Buchsbaum: It's not in the filing either.

Wheeler: → It's obviously not in the filing if it's not in the provisional.

Bernstein: No.

Wheeler: → Can you make reference to something...let's say he uses the word "zoom".

Boehm: Exactly. I'm pretty sure the word "zoom" is in there, isn't it Eliot?

Bernstein: But what Doug's saying is that had you written the patent, you would have described the invention as the ability to do this great zoom that we all...and just said this is the cool part of what we're doing. What Ray's missing in the



Lorraine Christine Hoffman, Esq.
Assistant Staff Counsel
The Florida Bar
File No. 2003-51, 109(15C)

outline is the ability for you to put a picture on a Web page.

Utley: He did know that an important element was the fact that when we went in and made it bigger, we didn't pixelate.

Bernstein: Not in here at all.

Buchsbaum: Not even mention to that concept.

Bernstein: Complete failure. It's not.

Boehm: But if said it doesn't distort when we zoom...

Bernstein: Nope. Nothing like that.

Boehm: That's the same thing, isn't it?

Bernstein: Yeah, but he hasn't said anything...he doesn't even tell you ...

Boehm: What about the panning element, or is that element not patentable?

Bernstein: No, that's part of the whole process is to be able to zoom while panning.

Boehm: Here it is. "The above process can be utilized in order to create higher zoom capability with each new depth layer of..."

Bernstein: No, but that's a new depth layer which is bringing in another hotspot image, so it's really a completely different subject.

Boehm: Oh. Okay.

Wheeler: Okay. Where is that?

Boehm: "Where the zoom capacity of up to 1700 times or greater may be easily obtained with the [present conventions.]" Are they talking about the hotspot now?

Bernstein: No.



Lorraine Christine Hoffman, Esq.
Assistant Staff Counsel
The Florida Bar
File No. 2003-51, 109(15C)

Boehm: No, it's the general zooming capability.

Wheeler: So it's not in addition.

Bernstein: Well, it's [] or it's missing.

Wheeler:  You guys didn't put it in the formal...I don't mean you...he didn't put it in the formal one and the fact that we want to zoom it, but could have without it being construed as an addition.

Bernstein: Yes.

Boehm: Well <Laughs; cannot understand his comment.>

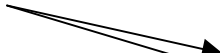
Wheeler:  Whether or not it's supported is a question that's going to be determined either between you and the examiner...probably not, it's between you and another lawyer someday when the case is litigated. And again, the test is: Can the average person skilled in the art—the average designer of this type of software—can he read this document and make and use this invention without inventing it? That's the test. Now, whether he uses the word "zoom" in here and "magnification" later, that doesn't matter as long as he would have gotten it. If it is so simple to build by reading this, you don't need any subject matter. If you're combining three elements A, B, and C, and A, B, and C are standard in art, and you tell them these are standard in the art, go combine A, B, and C, that could be a one-page application. The average person will pick it up and he could. It's a patent test. Are you with me? The more complex it is, the more you want it supported in this text.

Wheeler:  What if it is basically simple, and he just wrote it as basically simple, does that support our position anyway though?

Boehm: Does that support our...Sure...

Wheeler: I mean, against another [] that infringes on our...



Lorraine Christine Hoffman, Esq.
Assistant Staff Counsel
The Florida Bar
File No. 2003-51, 109(15C)

Boehm: Right. Yes. That is what I'm saying. I hope so.

Wheeler: So then I don't know that, at least from this [__]...

Bernstein: That's the provisional you're reading though, right?

Boehm: Aren't they the same? I think they're identical, aren't they?

Utley: You can check in his notebook.
Boehm: Are there differences?

Bernstein: Where did you find that piece?

Wheeler: Is the reason...now continue answering my question...is the reason we came to the formal in March of this year, which I didn't realize that [Joa?]. I thought that we had agreements for doing everything, but apparently [Joa] filed...

Boehm: For that one, yes.

Wheeler: But he didn't bother telling anybody.

Boehm: That's the one that we didn't find out until way late.

Wheeler: Okay, perhaps the reason that he did that was that was the easiest way to do it and the course of least resistance, and he thought he could go back...is there an amendment procedure?

Boehm: Yeah, there's an amendment procedure.

Wheeler: That he could do it a few months later or something like that?

Utley: We had a conversation before the formal filing, and, in fact, I have my notes here from that conversation.

Wheeler: Okay.



Lorraine Christine Hoffman, Esq.
Assistant Staff Counsel
The Florida Bar
File No. 2003-51, 109(15C)

Bernstein: And he mentioned that there was no zoom.

Utley: Yeah, I said...

Bernstein: Claim one.

Utley: Yeah, Here are my notes. This is my original copy. "[Graves? Ray?] did not reference []. The patent ap does not cover providing enhanced digital image zoom and pan control. It covers creating enhanced pages to show zoom and pan functionality without distortion." Those are my notes.

Bernstein: And you told him that.

Wheeler: Here's a man that was cognizant of what was necessary to be in there. Hired a guy to file a patent without any of us—obviously, not me, but Eliot, Brian...

Boehm: Jim wasn't around yet.

Wheeler: Okay, but Chris was and so on and so forth—how did they get through the crack that he did this?

Boehm: It didn't get through the crack. Brian addressed it with him.

Bernstein: And everything is shredded now, too. Everything else is shredded.

Utley: Kind of what he was going to do—his time factor—he was going to...he didn't think he would get this done. He would submit it and then would turn right around and amend it.

Boehm: Did he really say that?

Bernstein: Yeah.

Utley: I wouldn't say amended, it was because [] was coming...

Bernstein: It was supposed to be in there.



Lorraine Christine Hoffman, Esq.
Assistant Staff Counsel
The Florida Bar
File No. 2003-51, 109(15C)

Utley: ...he was going to smash that all together and finalize it.

Wheeler: Was that the same time, Brian, that he was leaving the firm?

Bernstein: Yeah.

Wheeler: So would you say that probably he knew at the time that he probably would be leaving?

Utley: Right.

Wheeler: But he wanted to get all of this in place so he could do the billing and get that part of it in...

Utley: I don't know that.

Boehm: Just speculating.

Wheeler: What day did you give him those [documents]?

Utley: I don't have my address book with me...I didn't write the date down, but it was the date that he was here. He came.

Wheeler: <Inaudible. Everyone talking at once.> That could be too. One other reason is...

Boehm: We're just speculating.

Wheeler: And I'm not trying to... <Everyone talking at once.> I thought he was trying to work on our best behalf, but one time or two times that I met him, he [] was trying to help. Who knows? Maybe he was incompetent. I mean we're only suggesting that...

→

Bernstein: Well, the fact that it's not in your patents, right up front, this is the invention, is a gross neglect. And the fact that it doesn't say, "this is what the invention is trying to do. This is the piece of..."



Lorraine Christine Hoffman, Esq.
Assistant Staff Counsel
The Florida Bar
File No. 2003-51, 109(15C)

Wheeler: The point is not whether it's gross neglect or not, it's what the damage is if there is...if, one, gross neglect is of any import; and two, what is the damage? [] That's what I think we need to ascertain here, and if we can ascertain it.

Utley: How do we fix it?

<Everyone talking at once.>

Boehm: Let me go over the procedures so everybody's clear. Again, on one end of the spectrum you file a very sparse, like a one-page provisional application, and it's cheap, and the purpose of the provisional is to get you in line...it is to protect your date. What you're trying to do is get the benefit of your priority date. When you invented it. When you're in line in terms of the next guy that invented it.

Wheeler: Sometimes they ask you the second day after who first invented...Who's the first inventor, that's what you're after.

Utley: I understand. I really understand...you don't physically stand...

Boehm: Not physically in line is right, or even in physically in line in order as well. Okay. One year later, the provisional expires and you have to file a non-provisional patent application, okay? Many times it's identical. If you do a good job up front, you just file that, but you need to put claims on at this time. When I do a provisional, I try, if there is money and time up front, to do it once up front. I even write the claims. As a matter of fact, I don't even like to file provisionals because there's not much of an advantage. If you've got the time and the money up front to do a good job, well then, just file it as a regular application.

Wheeler: Understand that at the beginning, the time and the money...I mean, the time was certainly available, but the money was a short substance.



Lorraine Christine Hoffman, Esq.
Assistant Staff Counsel
The Florida Bar
File No. 2003-51, 109(15C)

So it was obvious that Ray would be working in
almost expeditious way.

Buchsbaum: Well, that's why Ray short-circuited us because
of all of that funk.

Boehm: Well, that's true because the filing date is
3/24/99...that was very early in the game.

Wheeler: We did it in your office...in your conference
room. The only meeting I had with him was while
we were going to file the patent.

Boehm: Okay, 3/24/99 is the provisional application.

Buchsbaum: That's what I'm saying.

Boehm: So even at a year, he filed the second one with
claims.

Buchsbaum: Well, Chris, two things happened during the year.
One, somebody was doing other things, even though
they knew that was coming up, and two, I guess
there wasn't a whole lot of money to allocate
towards doing that much.

Wheeler: Here's what we did. We hired Ray [Joa?] on the
monies that were raised by the investors; and
then when Huizenga was coming in with their
money, and when that money came in, we made a
company decision that the first and foremost
thing was to get the patent filed properly. So
the fact that we were going to spend more money
and get them completed at that point had already
been reached.

Buchsbaum: Okay, but prior to that, we were working on short
forms. Then after that, we started to raise
capital, and we always knew that the priority was
intellectual property, so were going to make sure
that those got done right. Brian's been working
on it ever since, and I felt comfortable...I
never did feel comfortable with Ray [Joa?]. . .just
an observation.

Boehm: Hmm...is it all patent attorneys? <Laughter>



Lorraine Christine Hoffman, Esq.
Assistant Staff Counsel
The Florida Bar
File No. 2003-51, 109(15C)

Buchsbaum: No, no, there's nothing wrong. He came in, he's a nice guy, he tried hard, you know, all the nice things, but his work always appeared sloppy, okay? And that's the only thing I can say. You're a patent attorney, you see what I did. If I'm wrong, then let me know; but to me, it looked like it was a little slipshod. And then he made some statements that really bothered me, too, that I don't think he should have made to a client, and that is that he was filing his own patent. <Chuckling.> I mean, personally, I haven't heard of a patent attorney in my life telling me that he's an inventor filing his own patent. It really did bother me.

<Everyone talking at once.>

Bernstein: Transmitting video files on a communication network for airlines and...

Buchsbaum: It probably meant nothing because I don't think the guy was of the nature to be stealing from us, but I don't know! But I'll tell you this, it did ring a bell. From a pure novice, it made me a little nervous. I asked Eliot why he was dealing with somebody, but we were assured that this was a good firm...

Buchs a bit paranoid too!!!

Let me look back in my...here with the provisional. You file a provisional, then within one year, you file a regular application with the claims. You can add claims to it; but if you add subject matter to it—in other words, if the zoom and pan concept wasn't well described, you have lost the benefit of that first phase. Right. Now why is that going to hurt you? Two main reasons. One is if you put it on sale—offered it for sale—or you publicly disclosed it, there are certain regulations that say you've got to get something on file, so if you had publically disclosed it, that would protect...getting the application on file will protect you from losing your []because of public disclosure and offer for sale. I think that's what he was trying to get the earlier dates for.



Lorraine Christine Hoffman, Esq.
Assistant Staff Counsel
The Florida Bar
File No. 2003-51, 109(15C)

Wheeler: Sure.

Boehm: I spoke with Ray when I was trying to get all of these files, and his comments to me were...when we were on the phone—you remember, we were asking him where was this stuff, and he said, well, he kept building on and he learned more as he got in there. After I reviewed these applications, I agree that you're learning more as you go along. I'm doing the same thing. So it's kind of a learning curve.

Bernstein: If they ever find a zoom description that adequately meets...especially in the claims...I mean, if you're reading the claims...

Boehm: But Eliot, he's going to say that the claims are of no import right now. All you have to do...

Bernstein: In the filings?

Boehm: In the filings. I can go amend those right now. We can sit down today and re-write them.

Wheeler: → We can definitely amend it. There's no problems.

Boehm: There's no problems.

Is Wheeler a registered patent attorney????

Wheeler: → There's always maybe a little money that's been dislocated.

?

Boehm: Here's the problem, and that's what I want to get across about that. If he's trying to claim zoom and pan and I rewrite the claims to claim zoom and pan, and the examiner says, that's great, but it's new ...

Bernstein: But it's in the provisional that you can zoom up to 1700 times.

Boehm: If my claim is supported by the spec on that date, then you're fine.

Bernstein: → Isn't it?



Lorraine Christine Hoffman, Esq.
Assistant Staff Counsel
The Florida Bar
File No. 2003-51, 109(15C)

Boehm: I can't answer that without going into the...

Bernstein: But when we read the provisional and we see that, it says...

Wheeler: Before this meeting took place, before we called this meeting, aren't you privy to everything that's been done?

Boehm: Oh, sure. I have everything.

Wheeler: So when Eliot asked you that question, why can't you answer it?

Boehm: Because there's no...in my opinion, there's no clear-cut answer, yes or no, on the embodiment or product. It's a judgment call.

Bernstein: So that's an exposure, and what if the judgment
→ is against us?

Wheeler: It's [an examiner] judgment call is what we're saying.

Boehm: The damage?

Wheeler: No, the examiner. <Everyone talking at once.>

Wheeler: Whether the subject matter is new or not.

Boehm: The examiner would...hold on...it's...

Wheeler: Who's judgment call is it?

Boehm: It could be the examiner's, if he catches it. If it's not caught, and you get it to patent and you litigate the patent, ... at court. Or if the examiner catches it and I want to appeal it to the board of appeals in the patent office, it's their...

Wheeler: → Okay, so we go to court and we're fighting over the patent, we would argue that it's supported by the zoom 1700 in our language, and the other side of it, say you have baloney that's too broad...



Lorraine Christine Hoffman, Esq.
Assistant Staff Counsel
The Florida Bar
File No. 2003-51, 109(15C)

Boehm: You didn't have your invention...

Bernstein: Then you lose.

Boehm: We would lose only if you had a bar date come in there if somebody else invented before you, or if you put something on sale...or if we offered something up for sale.

Bernstein: Which we did.

Boehm: But the offer-for-sale date from our first meeting is not until September.

Bernstein: Right.

Boehm: So the offers for sale won't normally kick off a foreign...

Buchsbaum: Could you explain to me what offer for sale means?

Boehm: Sure. As soon as you...you can't get a patent on a product after you've been using it for more than a year. As soon as you publically disclose your invention, you've got one year in the United States to get a patent on file, okay? Even if you don't publically disclose it...let's say I've got a method of making [] in my factory, but it never gets outside. I'm starting to commercialize it, I'm making money off my invention...the commercialization date a year later is you can't patent it in the U.S. So that's that one-year grey period.

Utley: Aren't we within that period?

Boehm: Yes. As far as we know, yeah. As far as we know.

Wheeler: Okay, somebody explain to me, what am I doing here? Why am I sitting here? Are we saying that Ray [Joa?], other than being sloppy, but there's not much damage that could have been done or can be done because we can fix it, which really would make you happiest to hear that.



Lorraine Christine Hoffman, Esq.
Assistant Staff Counsel
The Florida Bar
File No. 2003-51, 109(15C)

Utley: Can I jump in? Let's just say there are two steps. We're going to make a filing this week; and to the best of my knowledge, we expect to have all of this done by Friday [] week, and that will be within the commercialization period. The second thing that we're going to do is we're going to look at filing an addendum to the original product filing to [expect] them to [] ... to the maximum extent that we can, if we need it...if we need it.

Boehm: I'll be a lot of this was swept up into...

Utley: What we're trying to do is protect the date...

Boehm: The original...

Utley: The original date as March the 24th, but filing should remain an objective.

Buchsbaum: Brian, if you broadened the language now, would that be a red flag to the commissioner that you should have done it earlier? Or should we just say that this has always been there?

Wheeler: You mean the examiner of...

Bernstein: We'd like to be able to say it was in the claim.

Utley: What happens when you start those amendments or broaden them is you start to admit that you didn't do it.

Boehm: Um, yes and no. We...I do that all the time.

Utley: It's common then?

Bernstein: If they do it all the time, then we have to do it.

Utley: But not until I feel more comfortable with it.

Boehm: We normally have a search done. The patent examiner will do a patentability search, and he will come back and reject it. The problem is if the claims are too narrow to begin with, he will



Lorraine Christine Hoffman, Esq.
Assistant Staff Counsel
The Florida Bar
File No. 2003-51, 109(15C)

not come back and reject it, he'll allow it, and boom! Now I can't amend it. [], we're done. But I can file an continuation on it. I can keep dragging this out and get broader claims as long as the subject matter is...

Utley: So that's why he started it broadly versus singly?

Boehm: No.

<Somebody comes into the room to take food/and or drink orders.>

Boehm: No, but in part, doing it broadly, if you're saying the claim is broadly...which I doubt the claim is as broad as the [] allows...

Wheeler: Right. That's what I'm saying.

Boehm: And this is claimed broadly.

Wheeler: Right.

Boehm: And that's the normal tactic, to claim things broadly, and then wait for the examiner to come back and say, "Oh, you can't get it that broad," and then narrow down your claim.

Wheeler: Okay, so isn't that what he was in part trying to do? That's what he's been saying, yeah.

Boehm: Yeah.

Wheeler: Well, would that not be consistent with how patent attorneys try to do things?

Bernstein: Well, claim one, if you look at their claim one, Chris, that they've written, it identifies...

Wheeler: Who's they?

Bernstein: [] and Marder. It identifies what you're trying to do.

Wheeler: Okay, so maybe it should have been written differently.



Lorraine Christine Hoffman, Esq.
Assistant Staff Counsel
The Florida Bar
File No. 2003-51, 109(15C)

Boehm: You won't get two patent attorneys to write the same claims.

Bernstein: Well, no, but you try to write the claim, and that's the teaching you and Steve and both represented us here, to describe in its broadest term...

Boehm: Right.

Bernstein: ...the invention.

Boehm: Well, I can't say that this isn't broad. This is very broad. This might be rejected for indefiniteness...I don't know what it is...but now he's got the opportunity to go back and...

Bernstein: → And Brian, you know, there's print film image in here, it's all supposed to be out of here.

Wheeler: What you're telling me is that in your corner of the world that all this going back and refining and refining and refining, that was wrong.
<Everyone talking at once; two different conversations going on at once.>

Bernstein: This is like he just completely ignored what we said over a year. He didn't do a thing. Nothing. No comments, nothing.

Boehm: And some people intentionally file narrow just to get something on file. Then they can come back and repair it without damage to it.

Bernstein: But you don't know that because an examiner...

Utley: You'll never know that until you have a litigation.

Bernstein: And then the question is what potential damage does that...

Utley: That damage potential and that remedy will be then taking place at that time, not now.



Lorraine Christine Hoffman, Esq.
Assistant Staff Counsel
The Florida Bar
File No. 2003-51, 109(15C)

And later from these transcripts



Lorraine Christine Hoffman, Esq.
Assistant Staff Counsel
The Florida Bar
File No. 2003-51, 109(15C)

Utley: Yeah, but after...I primed everybody, we can get guys to sign.

Buchsbaum: We aren't that many. I don't know on that sheet what you have, but I don't think there are that many names.

Buchsbaum: There's aren't that many...you don't have that many. I don't know on that sheet you have, I don't think there's that many names.

Boehm: No, there's not.

Utley: We had early problems with Jeff, if we can get Jude and Brett.

Wheeler: You just have to get them all around and sign.

Utley: No, that should not be an issue.

Buchsbaum: That might be questions brought up when people do due diligence.

Bernstein: That's why we're disclosing it. Right?

Wheeler: We'll record what's in the patent now.

Utley: They do. We have a piece that's not in any part of the original filings, which is the reduction of the technology to a disciplined concept—the mathematical representations of how it works and stuff like that.

Buchsbaum: That will also be included in there, right?

Boehm: We'll put it in the new filing...one of the new filings.

Wheeler: My opinion of everything, and we can talk about post solutions but I think Brian wants to get this back on track, but to me there's bad news and there's good news in this. The bad news is, just like anything in life, perhaps we would have liked to have tidied up some things better, like those having [Joa?]tidy them up. The good news is considering the state that the corporation was in



Lorraine Christine Hoffman, Esq.
Assistant Staff Counsel
The Florida Bar
File No. 2003-51, 109(15C)

in the early stages and the variable limited resources that it had, I'm glad that we have an awful lot on record that we do have on record, to be honest with you.

Utley: As long as it's not to the detriment of what we thought we were filing, I have no...I couldn't agree with you more.

Wheeler: But I think I like your approach, and I assume it's your approach, too, in that I assume that you're doing a fairly comprehensive new one, but then you're going to probably...

Utley: Claim prior back to the old one.

Wheeler: Right, but you're also going to do your amendment because now we're finding out that it's not an uncommon procedure and it's not a red flag.

Utley: Two things: the new filing on Wednesday will claim priority all the way back for as much as possible back to March 24th last year. Second, we will look at the March 24th year 2000 filing and determine how we should amend that to include additional claims and broaden that claim so that it more fully represents the knowledge of the invention as of that time.

Bernstein: Does it claim all the way back?

Wheeler: It'll go all the way back as long as...

Boehm: You don't go outside what was described.

Bernstein: No, the math is just describing the original invention.

Boehm: We'll, I'll never know the answer to that until it's litigated.

Utley: Due diligence.

Bernstein: Right, but from your perspective here, that's what we're setting up. Correct?

Boehm: We're going to try.



Lorraine Christine Hoffman, Esq.
Assistant Staff Counsel
The Florida Bar
File No. 2003-51, 109(15C)

Bernstein: Okay.

Wheeler: The question never even gets answered half the
→ time in the real world. The guy will claim
priority back on the document, and then if nobody
cares,...

Bernstein: It gets through.

Wheeler: It gets through.

→ Buchsbaum: Would it be a fair assessment—I'm posing this
more as a novice, not as an attorney here—since
we're not at IBM and we don't sit down at the
very beginning and work out all these equations
and all that, that in an invention such as this
by a Ma-and-Pa type of inventor, and now since
we're getting into the nuts and bolts and really
uncovering, in essence, what's behind it, as
Brian dissected it as we moved along, but that's
all we're doing? I mean, that Ma-and-Pa inventors
do that as they go along? They add the flesh to
the bones as they go along?

Boehm: Boy, that happens, and we try not...we try to
minimize the amount because if the flesh that you
have to add is new subject matter and you've
already sold your invention a year ago, you're
dead.

Buchsbaum: Let me at it a different way. It does this, but I
can't describe how it does this. But now we find
out...we tell you what it does, now we're telling
you in detail how it does it.

Boehm: Yeah, in terms of we claimed it properly.

Buchsbaum: So I'm not adding flesh in defense...

Utley: New flesh.

Buchsbaum: ...new flesh. I've got the box, now I'm
disclosing what's in the box including the gears
and how it works.



Lorraine Christine Hoffman, Esq.
Assistant Staff Counsel
The Florida Bar
File No. 2003-51, 109(15C)

Utley: No. Here's what the big difference is. The original filing claims a process for print film imaging.

Bernstein: Well, that was all stricken, by the way. That's why I'm having a big problem. I was going to get to that next, Brian.

Utley: Okay, good.

Bernstein: But we have discussed with Ray [Joa?] numerous times to take out the references to print images. Over the course of the year in the 59,000 modifications back and forth, we continuously pushed him away from the words that I see in this filing, and that's what's so disturbing to me because we sat there when...

<End Side 1; begin Side 2>

Buchsbaum: That would be conditional, probably.

Utley: Right, they probably will.

Wheeler: Right. As a matter of fact, they may say take your...

Utley: Crossbow knows that it would be converted to equity when someone else comes in.

Si? Right, and that's gone. And those issues are gone. So it adds new value.

Boehm: Well, Yeah, so it was intelligent...and I'm not...

Utley: By the way, if we did do a deal by which we tried to collateralize it even further, then we'd have to have some sort of provisions as well to get rid of [].

Buchsbaum: Yes, of course. As soon as it converts to equity, it's gone.

Wheeler: But I mean, what if you didn't convert your []?



Lorraine Christine Hoffman, Esq.
Assistant Staff Counsel
The Florida Bar
File No. 2003-51, 109(15C)

Buchsbaum: Then you'd have to lose it anyway.

Wheeler: But at a point. It just becomes a normal stockholder...

Buchsbaum: Right. It would have to drop away or something. For instance, it would drop away when theirs drops away.

Utley: The stockholders, in the event of a default, the stockholders, the distribution that takes place, includes all the stockholders according to the rank of the preference. So the preferred get first cut, and the common stockholders get the second cut, whatever is for distribution. [] unless there's nothing to distribute.

Boehm: Not if one of the preferred stockholders has a collateralized position and the others don't. If one of these preferred stockholders...

Utley: ...those stockholders that have the collateralized position.

Boehm: That's true.

Buchsbaum: You're talking about the small lump of money, [] any value, it should be reasonable value, and those should be taken out anyway.

Utley: Except that we seem to feel that we have an obligation to those, particularly the other stockholders who...

Buchsbaum: A good way to do it is the way he said to do it, and that's to [].

Utley: Will you look it up and see what it's going to take to do it?

Wheeler: I'm not clear. What are we trying to do? Are we trying to provide for collateral for new money coming in, or are we trying to...? We're not trying to collateralize money which has already been...



Lorraine Christine Hoffman, Esq.
Assistant Staff Counsel
The Florida Bar
File No. 2003-51, 109(15C)

And further in this transcript



Lorraine Christine Hoffman, Esq.
Assistant Staff Counsel
The Florida Bar
File No. 2003-51, 109(15C)

Buchsbaum: Then you'd have to lose it anyway.

Wheeler: But at a point. It just becomes a normal stockholder...

Buchsbaum: Right. It would have to drop away or something. For instance, it would drop away when theirs drops away.

Utlely: The stockholders, in the event of a default, the stockholders, the distribution that takes place, includes all the stockholders according to the rank of the preference. So the preferred get first cut, and the common stockholders get the second cut, whatever is for distribution. [] unless there's nothing to distribute.

Boehm: Not if one of the preferred stockholders has a collateralized position and the others don't. If one of these preferred stockholders...

Utlely: ...those stockholders that have the collateralized position.

Boehm: That's true.

Buchsbaum: You're talking about the small lump of money, [] any value, it should be reasonable value, and those should be taken out anyway.

Utlely: Except that we seem to feel that we have an obligation to those, particularly the other stockholders who...

Buchsbaum: A good way to do it is the way he said to do it, and that's to [].

Utlely: Will you look it up and see what it's going to take to do it?

Wheeler: I'm not clear. What are we trying to do? Are we trying to provide for collateral for new money coming in, or are we trying to...? We're not trying to collateralize money which has already been...



Lorraine Christine Hoffman, Esq.
Assistant Staff Counsel
The Florida Bar
File No. 2003-51, 109(15C)

Utley: Right. So if we claim all the way back to March of last year, do we need to touch the filing that's already in motion?

Boehm: The one that's out there?

Utley: Yes. Do we need to touch that?

Boehm: No, no. There's a PCT and a US.

Utley: Right.

Boehm: The PCT, we will get a search back. In fact, we should get it in a month or so, and then you'll decide what you want to do with that, what foreign country and possibly the US, but he files the same thing basically in the US, and now it's in line in the US.

Utley: Right, right. But what I'm saying is if the new filing that we make this week creates priority all the way back and embraces all of the teachings of the prior...

Boehm: Zoom and pan stuff.

Utley: Zoom and pan stuff, filings, do we need to go and modify and update and amend those other two?

Buchsbaum: Or would that be your recommendation?

Boehm: It depends on two things. One is how quickly do you want to get the US for the new filing? This is a PCT that we're preparing right now. If we file the US right away with it, then it makes less difference.

Bernstein: Less?

Boehm: Less difference because he's in line sooner. That's all. It just depends on how soon you want to get your patent.

Bernstein: Well, we want to go for the sooner.

Utley: The sooner the better.



Lorraine Christine Hoffman, Esq.
Assistant Staff Counsel
The Florida Bar
File No. 2003-51, 109(15C)

Bernstein: Right.

Boehm: Except you're going to get an office action back from the patent office on here...

Bernstein: On that.

Boehm: For free. There's nothing involved.

Bernstein: Right, but it doesn't claim anything.

Boehm: I don't know yet. It claims...he'll get this blasted. It will will be rejected.

Bernstein: Yeah.

Boehm: It will be rejected. The question is do we want to pick this, or where are we with the other things? So there's no decisions to be made now on this, it's just that do you want to file a US and a PCT?

Bernstein: And we do want to fix the original work?

Boehm: We can decide that later.

Bernstein: Well, why would we leave it unfixed?

Boehm: Because you can't get two patents on the same thing. So if we fix this, you're not going to get it over here.

Bernstein: But then we lose the date.

Buchsbaum: No we don't.

Utley: That's what he's saying.

Buchsbaum: You really don't lose the date.

Utley: Because he's stating all the way back.

Boehm: We may. It depends on...

Bernstein: May and less, these are words that scare me.

Boehm: You don't like that, do you?



Lorraine Christine Hoffman, Esq.
Assistant Staff Counsel
The Florida Bar
File No. 2003-51, 109(15C)

Bernstein: No, I do not.

Boehm: But I don't think this is the right time to make that decision now.

Utley: What is the right time?

Boehm: When we get the [] action back on this patent. And when we hear from the patent office, we'll sit down and see if we want to take this, or do we want to take this, or have we uncovered some killer Prior Art that blows this whole thing out of the water? You don't want to spend money right now if you can avoid it.

Utley: We've never done a search, have we?

Boehm: We did a search...I've done a search on...<Everyone talking at once.> on a dozen patents that really weren't on points. We didn't find any close Prior Art; and all I can tell these...

Utley: This was on imaging and video?

Boehm: Yeah.

Utley: That's incredible.

Buchsbaum: Yeah, it was huge.

Bernstein: If it is found impossible to do these things, why would people be doing them?

Boehm: I want to make...the tape recorder's off, right?
<recorder turned off>

Buchsbaum: What does PCT mean?

Boehm: Patent Cooperation Treaty. It's a formal filing process for filing foreign patents.

Buchsbaum: ~~Oh, that's the thing with the different~~ countries?



Lorraine Christine Hoffman, Esq.
Assistant Staff Counsel
The Florida Bar
File No. 2003-51, 109(15C)

Buchsbaum: Reality, though, this is not the...more likely six to nine months as some licenses start to unfold here and as things start to come back, and that's when this thing will start to have some relevance more than it does right now? From the standpoint of the...

Boehm: The patent technology?

Buchsbaum: No, no. The technology has a value that can be created in the marketplace and turned to bidding.

Utley: Well, you can look at the technology as almost value added to the company. I mean, the company has worth because of the process and what we can provide and we can build it up. But it'll even astronomical more worth assuming that we have...that it's totally proprietary to ourselves. Now some companies have great technology that's proprietary to themselves, and it doesn't earn them money. For instance, Wang Laboratories went down the tubes. They had the best word processing, and they had the best of everything else. And, of course, a lot of their technology is licensed out there, as I understand it, to VisionAire and to...they did the true ones, and...

Buchsbaum: It's was also to get to the possible strategy for the company's investors, okay?

Utley: Right.

Buchsbaum: Or it may be at some point a window of huge value placed on this technology where you may take advantage of it.

Utley: Well, and to our investors, we have said, and we can continue to say, we are attempting to create a pool of intellectual property and protect it.

Utley's dep says we had no patent pool

Buchsbaum: Okay.

Utley: But there can be no assurances that this will withstand the test of time.



Lorraine Christine Hoffman, Esq.
Assistant Staff Counsel
The Florida Bar
File No. 2003-51, 109(15C)

Boehm: That is exactly it. And you never want even one addition. You will get a good comfort level when you have a US patent issued in your hands.

Bernstein: Why?

Boehm: Because you've had an examination.

Buchsbaum: Because you've got some review.

Boehm: Because you have a presumption of validity.

Bernstein: For our part, we need to get that first one corrected because that's the first one that's going to be examined.

Boehm: No, we've got one...oh, yeah, it is. It's the US.

Bernstein: And therefore I want that to be important. The investors are going to say...

Wheeler: The first one that we're going to be issued will be Issue One.

Bernstein: And the investors are going to say what happened to 2001.

Boehm: 3/10 of 2000 was when it was filed. Typically a year...they'll get around to it within a year. Maybe it'll issue in. Anything less than two years...

Buchsbaum: From right now or from then?

Boehm: From 3/10.

Bernstein: What is the process speed up? If you can show...

Boehm: If you can show somebody's infringing, you can have an expedited examination; but that doesn't always buy you much time, and you really have to get into the patent office the first time, and I'm not sure we can do that.

Wheeler: Wouldn't a good example of one way be that Apple had really great patents, and Microsoft was still



Lorraine Christine Hoffman, Esq.
Assistant Staff Counsel
The Florida Bar
File No. 2003-51, 109(15C)

able to come in and duplicate it, even though everyone knows they violated the hell out of the patent of Apple.

Boehm: Um, hum.

Wheeler: So I mean you could have a good patent and it could still go down the tubes. But another one I'm thinking of that did stand up was Polaroid had patents and Kodak tried to come in and do everything to distinguish, and whether they will go and get clobbered, right? And there's probably a lot of every variation in between.

Boehm: Yeah.Wheeler:

Wheeler: Are those the two extremes?

Boehm: Yeah, those would be the two extremes.

Utley: Especially when it comes to method patents and software patents.

Boehm: Yeah, what was the first thing that...and the more patents you have, the less chances. It's like putting out mine fields...less chances to get around you. But if the original concept is broad enough and claimed right, Yeah, we can be okay.

Wheeler: But what I guess what you're asking for is when we have that first claim promised, probably within two years of when you filed, which is March 10, 2000, I would probably say come back, close it out again.

<Inaudible comment.>

Boehm: There were two points. One was the PCT [].

Buchsbaum: Right.

Boehm: The second point was everybody was saying you don't destroy documents. Lawyers do destroy documents; and in the patent realm, it is common practice to get rid of all of our attorney notes, but it depends on what the practice is in your



Lorraine Christine Hoffman, Esq.
Assistant Staff Counsel
The Florida Bar
File No. 2003-51, 109(15C)

—————→ law firm and your corporation. Most patent attorneys who use this practice that I've seen, it happens after it's issued. You never do it before. I don't even like to do it then. I like to do it after all the...

Bernstein: I don't even understand why you're destroying it. If you've got nothing to hide and everything's on the up-and-up.
—————→

Boehm: But throw in the concept that I'm leaving the law firm. Let's say I'm leaving the law firm, my notes, let's say, who's going to follow up and destroy my notes to benefit you, because I do want them six months from now. Maybe that's what he's doing.

Wheeler: → Yeah, he could have done it to protect you. He didn't want them around in the other office.

Bernstein: I don't know. I don't know. I don't even know if he knew he was leaving then.

Utley: Let's close it up. Let's file PCT and US on the new one. We're going to wait for the old one to get kicked back; and when it gets kicked back by the examiners, we'll then determine how we want to amend it. Is that what you said?

Boehm: No, I want to say something on that again. I think if you want a patent to pop quickly—if that's the goal, which sounds like it's a good goal—then, no, I think we should amend the claims with a preliminary amendment before the examination.

Utley: A preliminary amendment?

Boehm: A preliminary amendment.

Bernstein: Encompassing everything we can throw in there?

Boehm: Yeah, whatever support there is. But a preliminary amendment on whatever it is on the...



Lorraine Christine Hoffman, Esq.
Assistant Staff Counsel
The Florida Bar
File No. 2003-51, 109(15C)

Bernstein: So we're going back to the original March 3, 2000, to encompass what we've embraced.

Utley: When will you be in a position to recommend what that amendment will look like?

Bernstein: It should look a lot like the one we just did.

Boehm: Yeah, that's...

Bernstein: That's my guess.

Utley: When will you be in a position to...

Boehm: I'd have to...a few days...

Utley: About a week or so?

Boehm: Oh, Yeah, within a week, sure.

Bernstein: Okay. That's good.

<End of meeting.>

And from Utley's deposition we find the following comments:



Lorraine Christine Hoffman, Esq.
Assistant Staff Counsel
The Florida Bar
File No. 2003-51, 109(15C)

Utley lies about why Meltzer was fired from doing patents. We had found major problems if not fraud in Joao's work. We found that Joao was writing patents in his name that sounded similar to ours and we decided to replace them with Foley and Lardner at the request of Wheeler and Utley. This next statement is a total lie as Meltzer still does patent work for clients.

Q. Why did the company choose to switch
Meltzer to Foley & Lardner?
A. Because Meltzer decided to

Page 22

discontinue intellectual property representation.
Q. In general for all its clients?
A. Yes.



Lorraine Christine Hoffman, Esq.
Assistant Staff Counsel
The Florida Bar
File No. 2003-51, 109(15C)

Proskauer Rose, et al. vs Iviewit.Com, Inc., et al. 8/22/02

1 was its purpose? 21

2 A. Twofold. One, it was the point of
3 entry, if you will, for the remaining 5 percent
4 equity holders. Secondly, Iviewit Technologies,
5 Inc. was assigned the intellectual property
6 rights.

7 Q. What firm performed the legal work
8 for Iviewit Technologies, Inc.?

9 A. For corporate matters, Proskauer
10 Rose and for intellectual property, our patent
11 attorneys.

12 Q. Do you remember what company that
13 was?

14 A. Well, until April of 2000, that was
15 the New York firm, Meltzer, Lipper & something or
16 other.

17 Q. Was Foley & Lardner ever involved?

18 A. Foley & Lardner became involved.
19 That's the Milwaukee firm. They became involved
20 in April of 2000.

21 Q. After Meltzer?

22 A. Um-hum. Yes.

23 Q. Why did the company choose to switch
24 Meltzer to Foley & Lardner?

25 A. Because Meltzer decided to

Pat Carl & Associates (763)591-0535 or (800)591-9PCA (722)



Lorraine Christine Hoffman, Esq.
Assistant Staff Counsel
The Florida Bar
File No. 2003-51, 109(15C)

Proskauer Rose, et al. vs Iviewit.Com, Inc., et al. 8/22/02

1 discontinue intellectual property representation. 22

2 Q. In general for all its clients?

3 A. Yes.

4 Q. Okay. To your knowledge, did Foley
5 & Lardner ever stop representing the Iviewit
6 companies?

7 A. Foley & Lardner took the position
8 that they would no longer represent Iviewit with
9 new intellectual property work, and eventually,
10 as I recall, did cease doing any work whatsoever.

11 Q. Why?

12 A. Basically due to lack of payment.

13 Q. Of its attorneys fee bills?

14 A. Yes.

15 Q. Do you know if those bills were ever
16 resolved by the companies?

17 A. I don't know.

18 Q. At the time when you left in April
19 of 2001, were those bills for Foley & Lardner
20 still outstanding?

21 A. Yes.

22 Q. Who were the principals -- getting
23 back to the Iviewit Technologies, who were the
24 principals of that company?

25 A. The same principals as the other

Pat Carl & Associates (763)591-0535 or (800)591-9PCA.(722)

And later from Utley's deposition



Lorraine Christine Hoffman, Esq.
Assistant Staff Counsel
The Florida Bar
File No. 2003-51, 109(15C)

Proskauer Rose, et al. vs Iviewit.Com, Inc., et al. 8/22/02

70

apologize for that.

A. Okay.

Q. Who is Ken Rubenstein?

A. Ken Rubenstein is an intellectual property department head at Proskauer Rose in New York, and he is the person who recommended Meltzer as the patent attorneys to take care of the Iviewit intellectual property matters.

Q. What's your background in IP?

A. Well, I hold a number of patents. I, as general manager of a major IBM facility, an intellectual property department of patent attorneys reported to me. I was involved in promoting IBM's intellectual property activities. I sold an IBM company with intellectual property attributes and a portfolio that went with the company. So I've been involved in various aspects of intellectual property for many years.

Q. Do you believe that one of the reasons why you were brought into Iviewit was because of your intellectual property background?

A. Yes.

Q. Who from Iviewit directed the firm that Rubenstein recommended to do the IP work?

A. Before I joined the company, it was

at Carl & Associates (763)591-0535 or (800)591-9PCA (722)



Lorraine Christine Hoffman, Esq.
Assistant Staff Counsel
The Florida Bar
File No. 2003-51, 109(15C)

Proskauer Rose, et al. vs Iviewit.Com, Inc., et al. 8/22/02

Eliot Bernstein.

71

Q. Was he satisfied with that firm's work?

A. I don't recall any complaint.

Q. Did you have any complaints?

A. No.

Q. Do you know if any intellectual property work for Iviewit was ever mishandled by any law firms?

A. No.

Q. Do you recall Proskauer ever agreeing to accept fixed fees for work, that's fixed fees for doing work for Iviewit?

A. No.

Q. Would you know if they did?

A. Subsequent to my employment, yes.

Q. I asked you if any law firms had mishandled any patent work for Iviewit. Do you know if any law firms failed to do necessary patent work for Iviewit?

A. I'm not aware of any law firms that did not complete their assignments.

Q. Did you oversee, subsequent to the beginning of your employment, the work done by the patent attorneys?

Pat Carl & Associates (763)591-0535 or (800)591-9PCA (722)

And again from Utley's deposition:



Lorraine Christine Hoffman, Esq.
Assistant Staff Counsel
The Florida Bar
File No. 2003-51, 109(15C)

And again from Utley deposition:

Proskauer Rose, et al. vs Iviewit.Com, Inc., et al. 8/22/02

and specifically in the MPEG area, there is a 75
patent pool that Ken Rubenstein is personally
involved with relating to licensing the usage of
MPEG based intellectual property. And the reason
this pool is established is because the licensors
basically formed a consortium or a pool for the
purpose of granting rights so that people in the
industry could practice the collection of
intellectual property, which was held across a
number of different companies. So they form a
pool and the pool collects the royalties and then
distributes the royalties across the pool
members.

Q. Was there ever patent pool errors?

A. There was no such pool that Iviewit
has ever been involved.

Q. So were there any patent pool
errors?

A. There was no patent pool.

Q. Do you have any idea what Eliot
Bernstein is referring to in his interrogatory
answers?

A. No.

Q. Were there any missing copyrights?

A. No.

Pat Carl & Associates (763)591-0535 or (800)591-9PCA (722)



Lorraine Christine Hoffman, Esq.
Assistant Staff Counsel
The Florida Bar
File No. 2003-51, 109(15C)

and from the Foley transcripts

Utley: Well, and to our investors, we have said, and we
 can continue to say, we are attempting to create
 a pool of intellectual property and protect it.

And from Utley's hand written notes you will see he claims that there are Major Missing items in Joao's work and he writes this in 3/9/2000 after he had been working with Christopher Wheeler, Kenneth Rubenstein and Raymond Joao on the patent since approximately 6/1999. It was a cover-up letter that attempted to show that Utley suddenly realized that items were missing and blame this on Joao when he had been working with Joao on these patents:



Lorraine Christine Hoffman, Esq.
Assistant Staff Counsel
The Florida Bar
File No. 2003-51, 109(15C)

516.747.0653
3/9/2000

Guidance
BIN 1 2 F101

Ray Joao

Ray, there are major missing items in docket's 1+6:

1. Claims do not reference stitching
2. Process is amended as shown on the diagram
3. The relationship between the enhanced digital image and the zoom and pan function together with controls is not clear
4. The description and claims stop at the production and loading of the image.

5. Object model Brian



Lorraine Christine Hoffman, Esq.
 Assistant Staff Counsel
 The Florida Bar
 File No. 2003-51, 109(15C)

Becker, Steven C.

From: Becker, Steven C.
sent: Monday, July 24, 2000 4:44 PM
To: Eliot I. Bernstein (E-mail); Brian G. Utley (E-mail)
Cc: Boehm, Douglas A.
Subject: PCT Patent Application for "Zoom and Pan" Imaging

*Have you
 this till all
 you got both
 these books*

Re: PCT Patent Application for System and Method for Providing an
 Enhanced Digital Image File
 Inventor: Bernstein
 Our Ref. No.: 57103/120

Brian:

During our brief telephone conversation today, you provided a few comments in response to my letter to you dated July 21, 2000. These comments were based on your review of the prior provisional applications, and are summarized below.

1. The step of "enlarging" is not essential for all embodiments of the invention.
2. The aspects of zooming and panning, and the function of the applet must be described in greater detail.
3. The disclosure relating to acquiring a photograph of a film video should be removed. However, the disclosure relating to processing one frame of a video according to the process steps of the invention should be retained.
4. In the provisional patent application having our reference number 57103/108, the flowchart in FIG. 2A does not match the corresponding description in the specification. Correction is needed.
5. Again, in the application for 57103/108, the claims in their current form may not be of the proper scope and should be revised.
6. You commented that the prior-filed PCT applications relating to enhanced video files did not specifically mention potential applications in radiographic images, X-rays, MRIs, etc. Regardless of whether these specific applications are supported, additional subject matter cannot be introduced to the prior-filed PCT applications unless additional patent applications are filed. Please advise if you would like us to file patent applications directed to these specific applications.

*IMAGE/and a video that
 we were focused on
 opposite of what Blankley says*

We discussed the possibility that the provisional applications currently on file may not provide sufficient disclosure to support all of the claims we may eventually want to file in the PCT patent application we are currently preparing, and therefore, the sale of images using this process in September, 1999 may bar patentability in some foreign countries. You instructed us to proceed with the PCT filing to preserve whichever foreign filing rights are available.

Accordingly, comments 1-5 will be incorporated in the above-referenced PCT patent application. If you have any further questions or comments, please do not hesitate to contact me.

Steve Becker
 Foley & Lardner
 (414)297-5571

*They say of poor
 on tape*

NOTE: The information transmitted in this correspondence is intended only for the person or entity to which it is addressed and may contain confidential and/or privileged material. Any review, retransmission, dissemination or other use of, or taking any action in reliance upon, this information by persons or entities other than the intended recipient is prohibited. If you receive this correspondence in error, please contact the sender and delete the material from any computer.

And further evidence that Joao was not sending complete files and applications were missing which turn up altered, we submit the following evidence:



Lorraine Christine Hoffman, Esq.
 Assistant Staff Counsel
 The Florida Bar
 File No. 2003-51, 109(15C)

JUN. 6. 2000 3:36PM 3RD FLOOR

NO. 920 P. 2/8

FOLEY & LARDNER

ATTORNEYS AT LAW

CHICAGO
 DENVER
 JACKSONVILLE
 LOS ANGELES
 MADISON
 MILWAUKEE
 ORLANDO

PISTAR CENTER
 777 EAST WISCONSIN AVENUE
 MILWAUKEE, WISCONSIN 53202-5507
 TELEPHONE (414) 271-2400
 FACSIMILE (414) 297-4600

SACRAMENTO
 SAN DIEGO
 SAN FRANCISCO
 TALLAHASSEE
 TAMPA
 WASHINGTON, D.C.
 WEST PALM BEACH

EMAIL ADDRESS
 dabohm@foleylaw.com

Via Facsimile

WRITER'S DIRECT LINE
 (414) 297-5718

June 6, 2000

Mr. Lewis S. Meltzer
 Meltzer, Lippe, Goldstein & Schlissel, P.C.
 190 Willis Avenue
 Mineola, New York 11501

Re: Transfer of IP files for IVIEWWIT.COM

Dear Mr. Meltzer:

As you may recall, I am the patent attorney at Foley & Lardner that is currently handling the Iviewit.com IP matters that were previously handled by Ray Joao of your firm.

I recently received the following correspondence from your firm: (1) the original Assignment recorded in the United States Patent and Trademark Office (USPTO) for your Docket No. 5865-8 (U.S. Provisional Patent Application No. 60/169,559); and (2) the USPTO Filing Receipt (copy attached) for your Docket No. 5865-1 for Application No. 09/522,721. Although I sincerely appreciate your firm's diligence in continuing to forward Iviewit materials to me, this latest correspondence raises some very serious issues with respect to the Iviewit.com IP matters that were supposed to have been transferred to Foley & Lardner.

I was not previously told about this U.S. Non-Provisional Application being filed (item 2 above). It does not appear in any of the correspondence previously sent to Foley & Lardner. This raises the question of exactly what was filed in the U.S. Patent and Trademark Office, since I do not have a copy of any filing papers for this application. Was a U.S. Declaration filed? What specification and claims were filed? Was an Assignment filed for this application? I must have this information in order to take over prosecution of this application.

More importantly, however, this raises the question of whether any other provisional or non-provisional applications have been filed in the United States or any other country. Both the client, Brian Utley, President of Iviewit.com, and myself have previously asked your firm to transfer all of the Iviewit.com Intellectual Property files to me. (See attached letter to you dated April 28, 2000.) When the files that were sent to me were incomplete, I sent an e-mail (copy attached) to Dawn Laffin of your firm, asking her to look for other Iviewit matters. I subsequently requested that Nicole, Ray's former secretary,

001.79391B.2

ESTABLISHED 1842

A MEMBER OF GLOMBECK WITH MEMBER OFFICES IN BEULI, BRUSSELS, DRESDEN, FRANKFURT, LONDON, SINGAPORE, STUTTGART AND ZURICH



Lorraine Christine Hoffman, Esq.
Assistant Staff Counsel
The Florida Bar
File No. 2003-51, 109(15C)

JUN. 6. 2000 3:37PM 33RD FLOOR

NO. 920 P. 3/6

FOLEY & LARDNER

Mr. Lewis S. Meltzer
June 6, 2000
Page 2

double-check that there were no other miscellaneous files that were not on the list of applications (also attached). Now I find out that, after three or four separate requests, all of the Iviewit patent matters were not transferred to us.

I formally request that you have your firm's Docket Administration Department review all of Ray Joao's files to ensure that all of the Iviewit.com materials have been transferred to me. Please forward all letters, memorandums, faxes, e-mails, notes, CD's, disks, and other correspondence between Iviewit.com and your firm, and between any third parties and your firm on behalf of Iviewit.com. It is particularly important that I know which patent applications were filed and what correspondence was submitted to the U.S. Patent & Trademark Office before the expiration of a critical date. Otherwise, the client could possibly lose patent rights. Please confirm that the attached "Iviewit.com Patent Portfolio" table, which lists the patent applications filed for Iviewit.com by your firm, is accurate and complete.

I also request that you contact Ray Joao to confirm which applications were filed in what countries and whether or not Ray has any additional Iviewit correspondence or materials that were not transferred to Foley & Lardner.

Furthermore, the client requests that I obtain a written confirmation from both you and Ray that all files, materials, and correspondence have been transferred to Foley & Lardner.

Please confirm receipt of this facsimile and let me know that these matters will be handled promptly and appropriately.

Very truly yours,

Doug Boehm
Douglas A. Boehm

Enclosure(s)

cc: Mr. Brian Utley, Iviewit.com

001.733919.2



Lorraine Christine Hoffman, Esq.
Assistant Staff Counsel
The Florida Bar
File No. 2003-51, 109(15C)

-----Original Message-----
From: Boehm, Douglas A. [mailto:daboehm@foleylaw.com]
Sent: Tuesday, May 09, 2000 4:33 PM
To: 'Brian Utley (Iviewit)'
Cc: Becker, Steven C.
Subject: FW: Iviewit.com Files

FYI ...

(Dawn Laffin is the office administrator person at Meltzer, Lippe.)

-----Original Message-----
From: Boehm, Douglas A.
Sent: Tuesday, May 09, 2000 5:28 PM
To: 'dlaffin@mlg.com'
Subject: Iviewit.com Files

Dawn --

As I mentioned on the telephone this afternoon, I received your Federal Express package this morning containing the Meltzer, Lippe files for Iviewit.com. The package contained 7 folders corresponding to your docket numbers 5865-1, 3, 4, 4.1, 5, 6, and 7. However, the file folder for your docket no. 5865-8 is missing. Furthermore, not all of the paperwork for the PCT application (your docket no. 5865-10) was included in the first file 5865-1 (which is the PCT's parent case). Is there a 5865-10 file also?

During our phone conversation, you agreed to review your docket and files for 5865-8, 5865-10, and any other 5865 matters for Iviewit.com tomorrow, and forward these files to me right away.

Thanks for your assistance.

--Doug

*Douglas A. Boehm
Foley & Lardner
777 East Wisconsin Avenue
Milwaukee, Wisconsin 53202
Tel: (414)297-5718
Fax: (414)297-4900
Email: daboehm@foleylaw.com*

NOTE: The information transmitted in and/or attached to this message is intended only for the person or entity to which it is addressed and may contain confidential and/or privileged material. Any review, retransmission, dissemination, or other use of, or taking any action in reliance upon, this information by persons or entities other than the intended recipient is prohibited. If you received this information in error, please contact the sender and delete the material from any computer.

Outgoing mail is certified Virus Free.
Checked by AVG anti-virus system (<http://www.grisoft.com>).
Version: 6.0.459 / Virus Database: 258 - Release Date: 2/25/2003

1

XIV. Foley and Lardner takes over patent filings from Joao based on improper filings and continues to file incorrect patents for Iviewit and personal patents for Mr. Utley to his home of Iviewit technologies, without notice to the Company. It is important to note that the patents to Utley's home are similar to the patents with bad math.

Mr. William Dick was introduced to the Company by Mr. Utley and Mr. Wheeler as an outstanding patent attorney that Mr. Utley had used at IBM. What was failed to be



Lorraine Christine Hoffman, Esq.
Assistant Staff Counsel
The Florida Bar
File No. 2003-51, 109(15C)

disclosed and did not turn up until Utley's deposition is that Mr. William Dick was the attorney involved with Mr. Utley in patent malfeasances at Mr. Utley's prior job at DTL. Had the Company been informed of this major issue, again we would have fired Mr. Utley and never hired Mr. Dick. This deception and misrepresentation led to even more problems with the patents that were not uncovered until much later. Foley and Lardner was brought in after Mr. Utley and Mr. Wheeler became aware of the problems with Mr. Joao's work. Foley and Lardner continued in a path that left inventors off inventions, although they had full knowledge of the true inventors, wrote patents secretly into Mr. Utley's name for digital camera and the zoom technologies source code algorithms and further sent them to his Utley's without assignment to the Company or investors and finally filed patents with wrong content, major math errors and changed titles.

We submit as evidence the following evidence to support the allegations that Mr. Wheeler, Brian Utley and now Foley & Lardner will continue to wreak havoc on the Iviewit patents by a series of malfeasances including fraud on the US Patent and Trademark office.

We start with the 1st series of events that have Foley and Lardner writing patents with switched inventors and bad math, although they had been corrected on all errors and were fully aware of the true inventors.

Here as evidence we submit an application whereby the name is switched at filing to the Patent office from Providing an Enhanced Digital Video file to Streaming an Enhanced Digital Video File, although subtle the change has major implications to one skilled in the art. You will also notice that Mr. Jude Rosario gets left off the filing and Brian Utley later tries to insert himself with the patent office.

Case of the changing patent title

Here we have evidence that on 6/1/2000 a day before filing to the USPTO a copy of what appears to be my hand notes prior to filing and you again clearly see Jude and Zakirul were the intended inventors. What else this shows is that on June 2, 2000 the name of the application changes to Streaming vs. Providing, a major difference completely against all we had talked about and perhaps limiting us. Who changes the title?



Lorraine Christine Hoffman, Esq.
Assistant Staff Counsel
The Florida Bar
File No. 2003-51, 109(15C)

JUN. 1. 2008 12:30PM 3RD FLOOR

NO. 859 P. 4/37

57103/111

DRAFT

PCT INTERNATIONAL PATENT APPLICATION
for
SYSTEM AND METHOD FOR PROVIDING
AN ENHANCED DIGITAL VIDEO FILE

162
231.8
Eu 31

Inventors: Eliot I. Bernstein
[home address]
[citizenship]
Zach Zakirul Shirajee
[home address]
[citizenship]
Jude Jude Rosario
[home address]
[citizenship]

FOLEY & LARDNER
Attorneys at Law
777 E. Wisconsin Avenue
Milwaukee, Wisconsin 53202
(414) 271-2400



Lorraine Christine Hoffman, Esq.
 Assistant Staff Counsel
 The Florida Bar
 File No. 2003-51, 109(15C)

JUN. 1. 2000 12:33PM 33RD FLOOR

NO. 859 P. 5/37

57103/111

TITLE OF THE INVENTION

SYSTEM AND METHOD FOR PROVIDING AN
 ENHANCED DIGITAL VIDEO FILE

CROSS-REFERENCE TO RELATED APPLICATIONS

This application claims the benefit of U.S. Provisional
 Application No. 60/137,297, filed June 3, 1999, U.S. Provisional
 Application No. 60/155,404, filed September 22, 1999, and U.S.
 Provisional Application No. 60/169,559, filed December 8, 1999.

FIELD OF THE INVENTION

The present invention relates generally to video
 imaging. More specifically, the present invention relates to a system
 and method for providing high quality digital video files for streaming
 across a network.

BACKGROUND OF THE INVENTION

Streaming video is a technique by which video is played
 in real time as it is downloaded over the Internet, as opposed to
 storing it in a local file first. A plug-in to a web browser, such as
 Netscape Navigator, decompresses and plays the data as it is
 transferred to a user computer over the World-Wide Web. Streaming
 video avoids the delay entailed in downloading an entire file and then
 playing it with a plug-in application. Streaming video requires a fast
 connection and a computer powerful enough to execute the
 decompression algorithm in real time.

In the field of streaming video, the primary design
 challenge is that the viewer desires perfect video quality over a

*1760
 #131.4
 EV 31*

*not true that
 it must be
 fast
 and our
 process
 increases
 quality of
 broadcast
 video*



Lorraine Christine Hoffman, Esq.
 Assistant Staff Counsel
 The Florida Bar
 File No. 2003-51, 109(15C)

FOLEY & LARDNER

ATTORNEYS AT LAW

CHICAGO
 CINCINNATI
 DENVER
 HOUSTON
 LOS ANGELES
 MADISON
 MILWAUKEE
 ORLANDO

FIRST STAR CENTER
 777 EAST WISCONSIN AVENUE
 MILWAUKEE WISCONSIN 53202-5387
 TELEPHONE (414) 271-2100
 FACSIMILE (414) 297-4900

SACRAMENTO
 SAN DIEGO
 SAN FRANCISCO
 TALLAHASSEE
 TAMPA
 WASHINGTON, D.C.
 WEST PALM BEACH

E-MAIL ADDRESS
 slbocken@foleylaw.com

WRITER'S CHECK LINE
 (414) 297-5571

August 1, 2000

Mr. Brian G. Utley
 President
 Iviewit.com, Inc.
 One Boca Place
 2255 Glades Road, Suite 337 West
 Boca Raton, Florida 33431

Changes title!!!!



Re: PCT International Patent Application
 Title: System and Method for Streaming an Enhanced Digital Video File
 Applicant: Iviewit Holdings, Inc.
 Our Ref.: 57103/111

Dear Brian:

We are pleased to confirm that the above-identified application was filed with the U.S. Receiving Office on June 2, 2000, and accorded Application Number PCT/US00/15408. In accordance with your instructions, all PCT member countries were designated, and the European Patent Office was appointed as the International Searching Authority for this matter. Enclosed for your records is a copy of the application as filed, the transmittal of filing fees, and the related notification from the United States Receiving Office.

Please note that the deadline for entering the national phase of this application is February 3, 2001. National phase may be deferred for another ten months, until December 3, 2001, by filing a Chapter II Demand for International Preliminary Examination. This Demand must be filed by January 3, 2001. For any country in which we do not meet the national phase deadline or, alternatively, the International Preliminary Examination deadline, the PCT application will be considered withdrawn.

ESTABLISHED 184

A MEMBER OF GLOBALEX WITH MEMBER OFFICES IN BERLIN, BRUSSELS, DAKAR, FRANKFURT, LONDON, SINGAPORE, STOCKHOLM AND STUTTGART



Lorraine Christine Hoffman, Esq.
Assistant Staff Counsel
The Florida Bar
File No. 2003-51, 109(15C)

FOLEY & LARDNER

Mr. Brian G. Utley
August 1, 2000
Page 2

We will forward reminder letters to you well before these deadlines. Please do not hesitate to contact our office with any questions or comments regarding this matter.

Sincerely,

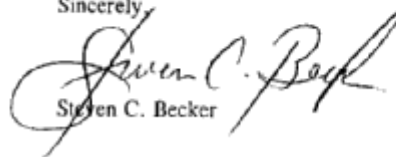

Steven C. Becker

Enclosure(s)

cc: Douglas A. Boehm

1.817090.1



Lorraine Christine Hoffman, Esq.
Assistant Staff Counsel
The Florida Bar
File No. 2003-51, 109(15C)

57103/111

TITLE OF THE INVENTION

SYSTEM AND METHOD FOR STREAMING AN
ENHANCED DIGITAL VIDEO FILE

31.6
Ev 31
Tab 1

CROSS-REFERENCE TO RELATED APPLICATIONS

This application claims the benefit of U.S. Provisional Application No. 60/137,297, filed June 3, 1999, U.S. Provisional Application No. 60/155,404, filed September 22, 1999, and U.S. Provisional Application No. 60/169,559, filed December 8, 1999.

FIELD OF THE INVENTION

The present invention relates generally to video imaging. More specifically, the present invention relates to a system and method for providing high quality digital video files for streaming across a network.

BACKGROUND OF THE INVENTION

Streaming video is a technique by which video is played in real time as it is downloaded over the Internet, as opposed to storing it in a local file first. A video player decompresses and plays the data as it is transferred to a user computer over the World-Wide Web. Streaming video avoids the delay entailed in downloading an entire file and then playing it with a plug-in application. Streaming video requires a communications connection (e.g., a network, Internet, etc.) and a computer powerful enough to execute the decompression algorithm in real time.

In the field of streaming video, the primary design challenge is that the viewer desires perfect video quality over a



Lorraine Christine Hoffman, Esq.
Assistant Staff Counsel
The Florida Bar
File No. 2003-51, 109(15C)

Next we submit that on a patent that was developed by Eliot Bernstein, Jude Rosario and Zakirul Shirajee that Foley and Lardner now drops Zakirul as an inventor and replaces him with Brian Utley. Read the fax cover notes to see how they start referring to Utley as an inventor! Also note that the application on the fax cover changes from 57103-111 to 5703-112.



Lorraine Christine Hoffman, Esq.
 Assistant Staff Counsel
 The Florida Bar
 File No. 2003-51, 109(15C)

JUN. 2. 2000 6:25PM 33RD FLOOR NO. 898 P. 1/35

FOLEY & LARDNER
 ATTORNEYS AT LAW
 FIRSTAR CENTER
 777 EAST WISCONSIN AVENUE
 MILWAUKEE, WISCONSIN 53202-8387
 TELEPHONE (414) 871-8400
 FACSIMILE (414) 887-4800

FACSIMILE TRANSMISSION



Total # of Pages 35 (including this page)

TO:	PHONE:	FAX #:
Brian Utley	(561) 999-8899	(561) 999-8810

From: Steve Becker
 Sender's Direct Dial: (414)297-5571
 Date: June 2, 2000
 Client/Matter No: 57103/111# 2
 User ID No: 1963

31.10
 EUB
 Tab 3

MESSAGE: **They try here to add Utley**

CONFIDENTIAL AND PRIVILEGED

Brian: Attached is a second draft of a patent application (our reference number 57103/112). Please review per the instructions in my prior letter of May 29, 2000. In particular, please ensure that all named inventors (Eliot, Brian, and Jude) read and understand the proposed claim scope. If you have any questions, please contact me. - Steve

If there are any problems with this transmission or if you have not received all of the pages, please call (414) 297-5444.

Operator:	Time Sent:	Return Original To:
		SCB

CONFIDENTIALITY NOTICE: THE INFORMATION CONTAINED IN THIS FACSIMILE MESSAGE IS INTENDED ONLY FOR THE PERSONAL AND CONFIDENTIAL USE OF THE DESIGNATED RECIPIENT. THIS MESSAGE MAY BE AN ATTORNEY-CLIENT COMMUNICATION, AND AS SUCH IS PRIVILEGED AND CONFIDENTIAL. IF THE READER OF THIS MESSAGE IS NOT THE INTENDED RECIPIENT OR ANY AGENT RESPONSIBLE FOR DELIVERING IT TO THE INTENDED RECIPIENT, YOU ARE HEREBY NOTIFIED THAT YOU HAVE RECEIVED THIS DOCUMENT IN ERROR, AND THAT ANY REVIEW, DISSEMINATION, DISTRIBUTION OR COPYING OF THIS MESSAGE IS STRICTLY PROHIBITED. IF YOU HAVE RECEIVED THIS COMMUNICATION IN ERROR, PLEASE NOTIFY US IMMEDIATELY BY TELEPHONE AND RETURN THE ORIGINAL MESSAGE TO US BY MAIL. THANK YOU.

001.789628.1

Cover Page 1 of 1



Lorraine Christine Hoffman, Esq.
Assistant Staff Counsel
The Florida Bar
File No. 2003-51, 109(15C)

Now for a case of bad math filed by Foley and Lardner engineers with the Patent office and further after being corrected on the math they still file wrong math and the letters that follow. See also the transcripts from 8/2/00 [Exhibit F](#) and 8/4/00 [Exhibit G](#) meetings.



Lorraine Christine Hoffman, Esq.
 Assistant Staff Counsel
 The Florida Bar
 File No. 2003-51, 109(15C)

AUG 2 2003 10:13AM

Vol. 1325 F. 17/40

Atty. Dkt. No. 57103/120

Window Aspect Ratio:

$0.8 > 0.75$ therefore:

$vwh = vwh = 320$ pixels

$vhw = vwh / 0.8 = 320 / 0.8 = 400$ pixels

should be view on p. 19

The Viewing Image size = $vls = 320 \times 400 = 128,000$

pixels — how does this equate to other, macro pixel, (15/14) magnifying

Need to second the photo or formula on p. 14

The Target Image size = $vis = vls \times 20 = 128,000 \times 20 = 2,560,000$ pixels

$TIS = \frac{vls}{MF}$

$TIS = \frac{128,000}{.20}$

The Target Image width = $\sqrt{2,560,000 / 0.8} = 1789$ pixels

$TIM = \sqrt{\frac{TIS}{SICR}} = \sqrt{\frac{2,560,000}{.8}} = 1789.25$

The Target Image height = $1789 \times 0.8 = 1431$ pixels

IS THE formula on p. 13 is right?

The Minimum Scan Density = $1789 / 4 = 447.25$ pixels per inch

$1,789 / 4 = 447.25$

The photo scan can be any scan density > 357 pixels per inch

447.25

Thus, a 4" x 5" print film image should be scanned at greater than 357 pixels per inch to allow magnification/zoom up to 20 times in a viewing window of 320 x 240 pixels. An enhanced digital image file having 2,560,000 pixels provides a sufficient number of pixels for this example.

EXAMPLE 2

Determine the Target Image size and dimensions, and minimum scan density for the following case:



Lorraine Christine Hoffman, Esq.
 Assistant Staff Counsel
 The Florida Bar
 File No. 2003-51, 109(15C)

Now after being corrected on math they file with the USPTO the wrong math again

AUG-04-00 12:46 PM THE ARMSTRONG GROUP, LTD. 732 747 5500 P. 03

Atty. Ref. No. 57103/120

and the viewing window is also shown. A zoom to the maximum level will be shown in the viewing window as illustrated at representation 120 of FIG. 7. By panning the viewing window, every portion of the target image may be viewed from each level of zooming.

To determine the minimum scan density (msd) to avoid pixelation at the desired maximum magnification factor (mmf):

$$msd = \frac{mmf}{vwh}$$

EXAMPLE 1

Determine the Target Image Area and dimensions, and minimum scan density for the following case:

Source Image = 5" wide x 4" high

Desired Magnification Factor = 20

Source Image Aspect Ratio = 5 / 4 = 1.25

Define the Viewing Window: assume 480 x 320h pixels

Viewing Window Aspect Ratio = 480 / 320 = 1.5

The Source Image Aspect Ratio is < the Viewing Window Aspect Ratio:

1.25 < 1.5 therefore: vwh

$$vh = vwh = 320 \text{ pixels}$$

$$vw = \frac{vh}{1.25} = 320 \times 1.25 = 400 \text{ pixels}$$

The Viewing Image Area = $va = 320 \times 400 = 128,000$ pixels

The Target Image Area = $ta = va \times 20 = 128,000 \times 20 = 2,560,000$

$$\text{pixels} \quad \sqrt{2,560,000 \times 1.25} = 1789$$

The Target Image width = $2,560,000 / 0.8 = 1789$ pixels

The Target Image height = $1789 \times 0.8 = 1431$ pixels

The Minimum Scan Density = $1789 / 5 = 358$ pixels per inch

The photo scan can be any scan density > 357 pixels per inch

Thus, a 5 x 4" print film image should be scanned at greater than 357 pixels per inch to allow magnification/zoom up to 20 times in a viewing window of 320 x 320 pixels. An enhanced digital

480 x 320
-13-

001.000000.4

RECEIVED TONE AUG. 4, 11:28AM

PRINT TIME AUG. 4, 11:34AM



Lorraine Christine Hoffman, Esq.
Assistant Staff Counsel
The Florida Bar
File No. 2003-51, 109(15C)

Evidence of why the math remained wrong follows, it is imperative to note that the patent that ends up going to Brian Utley's house unbeknownst to the Company has the correct math. So it appears that Foley and Lardner knowingly was making the Iviewit patents have errors so that Brian Utley could steal the same formulas in his own name to his home. Looking back it is easy to establish intent, then it just seemed like incompetence.



Lorraine Christine Hoffman, Esq.
Assistant Staff Counsel
The Florida Bar
File No. 2003-51, 109(15C)

Armstrong, Si Bernstein, and Eliot. Okay, guys.

Armstrong: And that, Steve, I think the most important question to have answered is what are our rights and obligation and opportunities to correcting this without any ill effects to us?

Becker: Yeah. There's plenty of opportunity essentially. We can file...if there are substantial errors in the application as it was filed, we can simply file a new application as soon as we get those fixed either on Monday or Tuesday or what have you. The goal of filing on Wednesday was to maintain priority back to the provisional application, which was filed a year ago.

Bernstein: So, did we lose that if they're wrong?

Becker: No, because we can only claim priority back to the extent that the subject matter was originally disclosed in the provisional filing of August 2nd of last year, and none of these equations were filed back then.

Bernstein: But the original process was.

Becker: Right. And the original process is the [] in the application. We're just talking about the details of the math examples that are in here. So we haven't lost anything.

Bernstein: Will we lose claiming back to the priority of the original provisional? So we did lose something, or am I incorrect in what I'm hearing.

Becker: No, we didn't lose...the original provisional can only provide priority for what was originally disclosed, and the math was not originally disclosed, right?

Bernstein: Well, no, but the math is a subject of the invention, not vice-versa.



Lorraine Christine Hoffman, Esq.
Assistant Staff Counsel
The Florida Bar
File No. 2003-51, 109(15C)

Becker: The reason I'm putting the math in there is essentially to provide concrete examples...

Bernstein: Of the invention.
Becker: Right.

Bernstein: But the invention was in there as of the priority date, and we had already talked with Chris Wheeler and everything regarding this. Were you on that conversation?

Becker: I don't remember.

Bernstein: Well, Brian, you were on that conversation. It's the conversation where we were going back to try to get the soonest date on the filing and correcting the provisional to encompass all of these things.

Utley: Well, you can't correct the provisional, but you can...what it does is it claims back for everything that references back to the original, but then incorporates all the new elements to bring it into...to make it into more of a complete statement.

Bernstein: I'm not sure I understand this. It was my understanding that we were going back to Ray [Joa's] patent and fixing it by inserting what we have here. When I talked to Doug, that was what he was under the impression we were going to do, and now that's all changed as of today.

Becker: You really can't fix a provisional application.

Bernstein: Not the provisional-the regular filing of August whatever-whatever day it was.

Utley: No, in March. March 24th.

Becker: Oh, okay. Yeah.

Bernstein: And that way, if that patent gets approved with all this in it, that's what we were doing, and we wanted that one to be approved



Lorraine Christine Hoffman, Esq.
Assistant Staff Counsel
The Florida Bar
File No. 2003-51, 109(15C)

first correctly because it obviously
expedites our life by a long way.

Becker: This is the PCT application file of March
23rd. Is that what we're talking about?

Utley: Yeah, but the way that I recall the
conversation, the spec cannot be changed...

Becker: Right.

Utley: ...but the claims can be.

Becker: Right, and they can be changed as long as
they're supported by teachings that are in
that specification.

Utley: Right.

Becker: Which is why you really...

Bernstein: And the specification can't change?

Becker: Right.

Bernstein: Why?

Becker: Because it would be kind of like...

Bernstein: I thought that was based on new matter.

Becker: That's exactly it can't be changed.

Bernstein: So it can be changed if it's still the same
matter?

Becker: The claims can be amended as long as they
are still fully supported by the matter
that's in the specification that's
originally filed. Now, if you want to change
your claims and they're not supported by the
specification as originally filed, then you
have to file a whole new application adding
new matter to your specification that will
support those claims.



Lorraine Christine Hoffman, Esq.
Assistant Staff Counsel
The Florida Bar
File No. 2003-51, 109(15C)

Armstrong: Does the fact that a direct interpretation of what in general amounts to typos and oversights, but a direct interpretation of that affect our ability to change that supporting matter of that matter? Because if we directly interpret the math in the certain circumstances here, it will bring you to a wrong conclusion if it's a direct interpretation without having to reverse such an error but was meant to occur.

Becker: Well, I see. Then we need to get the math right, but it doesn't affect our priority. Only by a few days essentially.

Bernstein: Well, do we lose the ability to claim priority to what we were trying to claim here...

Becker: No.

Bernstein: ...by that date? So you can go back in and change the matter of this?

Becker: You don't go back and change the matter, you just file a new application which claims priority back to a prior application only for the subject matter that was...

Bernstein: But we missed that application.

Becker: No, we've got it in the form of this continuation, or this PCT, that we filed claiming priority back to that patent application. So we've preserved that chain of priority.

Armstrong: Are then completely confident that errors that we need to correct right now then are not going to hurt us in any way, shape, or form as being able to claim as part of our invention all of the correct things that we want in there?

S. Bernstein: That's what I heard at that meeting, that we could go back and re-do that at a later date without having any implication.



Lorraine Christine Hoffman, Esq.
Assistant Staff Counsel
The Florida Bar
File No. 2003-51, 109(15C)

Bernstein: As long as it wasn't new subject matter.

S. Bernstein: Exactly right. These are just corrections to the...

Bernstein: They're corrections, they're math, whatever.

S. Bernstein: Okay, but we're not saying this is a new way to get to that.

Bernstein: No.

S. Bernstein: Okay, that's what I heard. That's the notes I took. Eliot, you should have that on the tape recorder so that we know that.

Armstrong: Well, we do, and that would also support, I think, another issue, which is that we now have to go through the refileing of something else which was originally corrected several days ago and was somehow ignored so that this whole refileing shouldn't even cost us anything.

Bernstein: Well, and beyond that, Doug <sic>, what I'd like to really get down to is a letter from you, in writing, explaining all of my, you know, both from the Ray [Joa] patent forward, and I think you need to talk to Doug about it, of what our potential pitfalls are here with these filing errors, what our potential pitfalls are, what it caused to happen with that priority, priority equals, and if there's any harm to us. Because we keep just slipping back by these things. This should have been right. I mean, we have well documented, and Brian's well documented, that these changes were sent, and now we've missed a priority claim to that by not being able to go back and change our last filing. I need to know the liability here.

Becker: You know, I was not there on Wednesday night. Brian talked to Doug on this and then made final changes, and then...



Lorraine Christine Hoffman, Esq.
Assistant Staff Counsel
The Florida Bar
File No. 2003-51, 109(15C)

Utlely: Yeah, Doug sent me a next-to-last copy, which I went through and there were a number of errors—I have my notes on each one of those at home—and then I reviewed each one of those with Doug, agreed on what they were, and then Doug was going to send me the last copy, which apparently he didn't because I never received it. At that point in time, it was, I guess, about 11:30 or 11:45 our time.

Bernstein: And these were also discussed in great length with him for a whole day on the phone.

S. Bernstein: Yes, well, how about in the...

Bernstein: No, no, Dad, this is separate. But at great length this was discussed, every one of these changes.

Becker: The changes you sent me here, is this Brian's handwriting?

Utlely: No, some of it isn't correct.

Bernstein: Well, let's go through it because I'd like to...

Armstrong: Yeah, let's go through it.

Becker: I don't know if that's going to help that much because it's a question of what actually was filed and whether it incorporated the changes that Brian asked for the last minute.

Bernstein: It didn't.

Armstrong: We know that. This is what was filed.

Becker: Brian, didn't you just say that Doug didn't send you the final draft of what was filed?

Bernstein: He did it the next day.

Becker: Oh, he did the next day?



Lorraine Christine Hoffman, Esq.
Assistant Staff Counsel
The Florida Bar
File No. 2003-51, 109(15C)

Armstrong: Yeah, Jim, can you forward that to Steve real quick?

Armstrong: What?

Bernstein: Email it to him...the final draft?

Armstrong: Yeah.

Becker: Well, I'm not going to question...

Bernstein: Okay, but we need to go through and get the changes acknowledged, accepted, have you put it into the next whatever you're going to do to solve this, with a letter explaining what we've lost here.

Becker: All right.

Bernstein: Okay. Any liability, potential liability where we're exposed to from this.

Becker: Oh, I wouldn't worry about it. You guys are making a mountain...

Bernstein: Well, you know, I gotta tell you, I worry a lot about it from what Doug told us. So, you know what I mean? You tell me not to worry, but then you tell me it's very important that we're accurate in this filing; and then we're very inaccurate in the filing, and then we're not supposed to worry. I'll feel much better not worrying with a letter from you explaining why I shouldn't worry.

Armstrong: Steve, what's at your email?

Becker: Sbecker@foleylaw.com.

Armstrong: Sbecker?

Becker: Yeah, "S" as in Steven, "becker."

Armstrong: Got it.

Bernstein: Okay. Let's just go through this with you, Steve, so we can get the next step done.



Lorraine Christine Hoffman, Esq.
Assistant Staff Counsel
The Florida Bar
File No. 2003-51, 109(15C)

Becker: All right.

Bernstein: Which is correcting the issues. Are you with us on page 13?

Becker: Right.

Bernstein: Okay. Jim?

Armstrong: On page 13, line 19, the expression of VWH should follow the way we express it in our definitions, which is VIH. Even though the two are equal, let's just follow the way that we have it expressed in our definitions on page 12.

Becker: Oh, I see. Okay.

Armstrong: Then on line 23, each of those expressions is not congruent with the way we've defined them. Despite the fact that we arrive at the same results, it doesn't apply the formula in exactly the same way. So for a reader, it ought to be the same. So for line 23, it should be the "square root of 2,560,000 times 1.25."

Becker: All right.

Armstrong: Okay. Not "2560 divided by .8."

Becker: Okay.

Armstrong: On line 24, it ought to be "1789 divided by 1.25."

Becker: I see. Okay.

Armstrong: Then on line 25, it ought to be "1441 divided by 4." Again, the results are the same; the expressions are not.

Utley: No, that last one, Jim, it's correct.

Armstrong: It's what?



Lorraine Christine Hoffman, Esq.
Assistant Staff Counsel
The Florida Bar
File No. 2003-51, 109(15C)

Utley: The scan density is 1789 divided by 5.

Armstrong: Okay, hold on. Scan density is defined by us as being...where the heck is it...oh, it's right up above..."target image height..." right up above on line 7..."minimum scan density is target image height," which in this case we just defined to be 1431...

Utley: Where are you reading from?

Armstrong: Line 7 of the same page. Line 7, page 13. So target image height is 1431 divided by the source image height, which is 4, so it should be 1431 divided by 4.

Utley: Well, the...I guess that that equation, "MSD equals TIH/SIH," did not come from my documentation.

Becker: Hold on, let me look at this documentation. I've got it right here, too.

Bernstein: Well, Steve, you have copies of this, too, that were sent to you...

Becker: Right.

Bernstein: ...of what Brian's looking at, several days ago. So how isn't this stuff flowing forward into the patents, especially when we pointed it out two times before filing? I mean, I'm just dumbfounded at this.

Utley: There was a change, Steve, which you were not involved...

Becker: The proper equations, that wasn't there the last night when the last changes were put in, so I can't really speak to it.

Bernstein: No, but he sent you his changes several days ago.

Utley: Steve, there was a change that we decided on on Wednesday afternoon, which was to reflect aspect ratio as width divided by height, which I made, and that was created by the



Lorraine Christine Hoffman, Esq.
Assistant Staff Counsel
The Florida Bar
File No. 2003-51, 109(15C)

desire to reflect aspect ratio the way that displays are expressed as opposed to the way photographic images are expressed. Photographic images are expressed the opposite way, and that's the way the documentation had been originally prepared. But it was thought that it was perhaps more consistent with current technology to express it the way that displays are expressed. So I went through and changed...

Becker: You mean from that change in [invention? convention?]?

Utley: Yes. So that caused the equations to be reconstructed to reflect the inverse of what was there before because the affect ratio now is inverted.

Becker: I see.

Utley: And what happened was Doug apparently did not pick up all of those changes, even though I went through them very methodically the last thing Wednesday night when he sent me his almost-final draft.

Becker: I see.

Utley: And, Jim, just for your edification, that also affected the MSD shifting from a height to a width orientation. The number is the same, but it changed it from a height to a width.

Armstrong: So what's the correct formula for MSD?

Utley: It's TIW/SIW.

Armstrong: Okay.

Bernstein: So, you made this change with Doug, and it's still wrong in the patent?

S. Bernstein: I'm a little concerned about the proficiency of the legal aspect of this. We sat there for hours, and then Brian stayed late into



Lorraine Christine Hoffman, Esq.
Assistant Staff Counsel
The Florida Bar
File No. 2003-51, 109(15C)

the night with this guy, and then he comes back and we don't file it right anyway? It seems like there's something wrong here. I mean, ...

Bernstein: I mean this is, yeah...

S. Bernstein: I mean, I'm just budding in because I have little or no knowledge as to what the numbers mean, I'm just listening to a conversation in which I'm hearing is that after four or five hours in a room locked together with lawyers and everybody else, we reach an agreement that those changes will be made. No, my understanding is Brian stayed and made those changes, and then the lawyer didn't file the changes? What's the sense of that?

Bernstein: These are good points. Let's move forward, Jim.

S. Bernstein: These are points that have to go back to stockholders with money invested.

Bernstein: That's why I've asked Steve to send us a letter of what's happening, what our exposure is, by Monday or Tuesday, explaining how this didn't occur, get in, and what we're going to do to resolve it, and what that resolve initiates in the chain of events.

S. Bernstein: Well, the other side of it is this. If after all of this precaution has been taken—and Brian, you can correct me if you think different—but after all of this precaution has been taken, it appears that the fallacy of worrying about it ever gets accomplished. Brian stays, everybody works on it, it's still filed wrong. Now what if Jim Armstrong hadn't caught it. Brian was on a plane today...

Bernstein: Then none of Brian's changes even sent several days ago even would have been in there. Math would have been wrong, equations



Lorraine Christine Hoffman, Esq.
Assistant Staff Counsel
The Florida Bar
File No. 2003-51, 109(15C)

would have been wrong, verbiage would have been wrong.

S. Bernstein: Am I right, Brian, in having this concern?

Utley: Well, yeah, obviously it's clearly a major concern because there's nothing more disciplined than the mathematical expressions.

S. Bernstein: And you're comfortable that what you did, even if some of them were wrong, that we could have later corrected...

Bernstein: No, Dad, we sat here with Brian and Jim and Doug, and we went through it, and we all agreed it was right, and those changes do not appear.

Utley: No, we...

S. Bernstein: That makes me very nervous. Well, it makes me nervous to the extent that are all of the other patents done right?

Bernstein: Well, that's what I'm...I'm going to start having somebody review all of this. I mean, obviously there's...it opens up a whole can of worms.

S. Bernstein: Well, the other thing that I heard was—and not negatively or anything else—but I heard that perhaps Ray [Joa] did this work and he was either concerned about it being a bit sloppy, blah, blah, blah, blah. What is the excuse for this law firm?

Bernstein: Well, let them write us what's happened here. I mean, I definitely need to see on paper, Steve, some kind of report on this. That it describes what occurred, why it's not reflected in the patent filings, and what our exposures are, and that'll tell us what we're dealing with in firm, etc., liabilities. I mean, we don't know that.



Lorraine Christine Hoffman, Esq.
Assistant Staff Counsel
The Florida Bar
File No. 2003-51, 109(15C)

Armstrong: We should continue to look at the changes so that he's copy that reflects everything.

S. Bernstein: Well, even if there is no liability, what I'm still concerned about, even if it can be corrected, it's the exact same position— Brian, am I right?—that we found ourselves in with the last lawyer who did it. Okay, thank God we can make changes, but that isn't the answer. Why not just get it right, get it filed...

Bernstein: No, don't just say thank God we can make changes, Dad, because all of that brings additional liability to you. You miss dates, you miss claiming, you miss this and that— words that are very tricky and confusing, and only these guys can understand. So that's why I need it to be put in writing so I can have it analyzed...

S. Bernstein: Absolutely, I want it definitely, because I need to take it...you know, I need to have board member approval...

Bernstein: Oh, I think our board is going to be disastrous with this stuff about several things when we take this to them. And we need to know from the Ray [Joa] level to the Foley-[Larver] level, how this is going to be cleared up and what the problems were that occurred.

End quip 2

Armstrong: It's redundant, but that's okay. Do you see any other problems with the formulas? Did you review all of this again today, Brian?

Utley: I've not reviewed anything today. I wasn't aware of the problem until about three minutes ago.

Armstrong: Okay. So that covers my comments on that.

End quip 3



Lorraine Christine Hoffman, Esq.
Assistant Staff Counsel
The Florida Bar
File No. 2003-51, 109(15C)



Lorraine Christine Hoffman, Esq.
Assistant Staff Counsel
The Florida Bar
File No. 2003-51, 109(15C)

Becker: Eliot, why don't we go through the list of things that you've asked me to do so we can be perfectly clear on this?

Bernstein: Okay.

Becker: The first is to amend Ray's PCT application, at least the claims, so that we have a good filing there, at least based on whatever Ray has in his specification. That's task #1.

Bernstein: Claims plus any additional language that's not new matter.

Becker: All right.

Bernstein: Okay.

Becker: You want a letter describing the...what was omitted or what was incorrect in this application filed Wednesday and to what extent that may have any bearing on rights.

Bernstein: Correct.

Becker: And also a course of action we feel is necessary to file new applications to amend these, make these corrections, or if there's something we feel we can do in an amendment that would not introduce new matter.

End quip 4

Transcription of Telephone Conference
Conducted July 31, 2000

Participants:

Eliot Bernstein, Maurice Buchsbaum,
Brian Utley, Doug Boehm, Chris Wheeler
Docket 57103-120

Note: Square brackets [] are used to indicate inaudible or indecipherable text. Text found inside brackets indicates transcriptionist's best guess. Since speaker names are not specifically identified, transcriptionist has made an attempt to identify based upon comments made in conversation but cannot guarantee that each



Lorraine Christine Hoffman, Esq.
Assistant Staff Counsel
The Florida Bar
File No. 2003-51, 109(15C)

Then after making corrections for two days we submit the following transcripts from a taped call submitted as [Exhibit G](#).

Transcription of Patent Meeting
Conducted August 4, 2000

Participants:

Eliot Bernstein, Jim Armstrong,
Brian Utley, Steven Becker, Simon Bernstein
Docket 57103-120

Bernstein: What bothered me about that as well is that we'd go through the math, and then suddenly you have a document Brian sent you several days earlier regarding the math that has a bunch of changes in it, and none of that's in there. I mean, I don't understand that.

Becker: ...was changed from that document anyway.

Boehm: Yeah, it was changed from that document anyway. I was working with Brian, who I thought was the master of that math, but...

Bernstein: But he had sent you an updated map three days earlier that didn't appear in the final document that we were trying to...



Lorraine Christine Hoffman, Esq.
Assistant Staff Counsel
The Florida Bar
File No. 2003-51, 109(15C)

Boehm: Okay, I don't know. Steve was handling that. I don't know whether...you know, Steve says he did put it in there, but then I don't...

Bernstein: But then we go through the document that we're filing, and it's not there.

Boehm: Okay, but we were on the third draft when I took it over. You guys had opportunities like crazy to...

Bernstein: But that's the thing. Brian had sent it to you earlier, and it still wasn't appearing in final drafts.

Boehm: If that's true, then something crossed in the email because Steve said he put it in there, and maybe there's a piece of the math missing between the crossing the emails. You're right in terms of...

Bernstein: Is Steve there?

Boehm: I don't know. He probably is.

Bernstein: And then my other question is quite a simple question my dad asked about electrical engineers being mathematicians and said, "Didn't they sit and pencil out the math of all this themselves?"

Boehm: Uh, huh. Here's what happened on that. Steve was filling the application. We worked with Brian and you, Eliot, on the application. In some of the letters and emails he said that he doesn't understand the math.

Bernstein: I'm not getting any of those.

Boehm: Huh?

Bernstein: I'm not getting any of those emails.

Boehm: Well, then, talk to Brian because we were corresponding with Brian on that, and I don't know why you weren't getting it if that was the



Lorraine Christine Hoffman, Esq.
Assistant Staff Counsel
The Florida Bar
File No. 2003-51, 109(15C)

case, and I don't know which letter went to who, blah, blah, blah, but I do know that we mentioned that we didn't understand the math, and we were up to the third draft, if I recall; and you're right, Jim, that it shouldn't have taken...it shouldn't have been last minute and you should have had time to do it. I totally agree, but I can't take total blame for that...

Bernstein: But wait a minute. Steve has fundamental errors on understanding the math, and yet we're going to file it with him having math problems?

Boehm: It's your duty to either help us to understand...

Bernstein: But then I've got a point. We did help you. We sat on the phone for an entire day, walked through this...

Boehm: The day of the filing you mean?

Bernstein: And if this math is still wrong, I mean, there's something really fundamentally wrong here.

Armstrong: Let me check it again.

Bernstein: Yeah, let us call you back in a while. Is Steve in today, too?

Armstrong: I didn't get involved until Wednesday.

Boehm: Right.

Armstrong: I'll tell you one thing, Doug, that you should do as just a matter of course going forward. Eliot being the owner of the company and the person that Brian reports to is any future email correspondence should always be copied to him. That's kind of just a standard practice we all do in the company.

Boehm: To copy?

Armstrong: Yeah.

Boehm: Okay. I didn't know that.



Lorraine Christine Hoffman, Esq.
Assistant Staff Counsel
The Florida Bar
File No. 2003-51, 109(15C)

Bernstein: You ask me to review and sign these patents, and you're not sending me information. What do you mean.

Armstrong: I think had we known that there was a question of validating Brian's math, Eliot would have brought me in a lot earlier.

Bernstein: I would have brought a mathematician in. I mean, this is ridiculous.

Armstrong: Yeah, I'm just a friend that's good at math, not a mathematician.

Boehm: Right, well.

Armstrong: Go to your meeting. We're going to check the stats out, and we'll talk to you letter.

Boehm: Well, you've got to talk to Brian, too.

Armstrong: Yeah.

Bernstein: I think because I now seriously have to report a lot of things to a board of people that we're going to have to have a meeting at some point either today or Monday with a few of the key people in the company who are investors, etc., so that they understand what they are investing or not investing in.

Becker: Don't jump to conclusions.

Bernstein: No, I'm not, but if this is correct, we've got some fundamental things that need to be discussed.

Boehm: If what's correct?

Armstrong: If he's correct about the math being wrong, but let's check it...

Boehm: No, I'll bet we could get a good patent if the math is totally wrong. I think we're barking up a tree here that's not a big wall.



Lorraine Christine Hoffman, Esq.
Assistant Staff Counsel
The Florida Bar
File No. 2003-51, 109(15C)

Bernstein: But wait a minute. The question is if it still remains wrong and we gave you the right changes, it should have been filed right. All the sudden I'm left with a patent that...

Boehm: Okay, talk to Brian.

Bernstein: I will.

Boehm: Brian gave me the right changes. I filed what Brian gave me.

Bernstein: Okay.

Armstrong: Okay.

Boehm: And I don't mean to...you know...yell out of that, but that's what happened.

Bernstein: That's no problem. I totally hear that.

Armstrong: Thanks, Doug.

Boehm: Okay. Talk to you Monday.

<Hang up phones.>

Bernstein: 8/4/2000. 8:30 Doug Boehm conference call. Jim Armstrong, Eliot Bernstein. Steve, Jim, everybody, I'm taping the conversation, 8/4/ patent discussion regarding Docket 57103-120 with Brian Utley, Steve Becker, Jim Armstrong, Si Bernstein, and Eliot. Okay, guys.

Becker: [], too, if that's all right with everybody.

Bernstein: Yeah, did you get the fax from Jim?

Becker: I haven't received it yet.

Armstrong: It was sent actually to Doug on the "cc" line, but to a machine at 297-4900.



Lorraine Christine Hoffman, Esq.
Assistant Staff Counsel
The Florida Bar
File No. 2003-51, 109(15C)

Becker: That's right. It'll go to our central fax department, and I just phoned up there and asked them to deliver that to me when it comes in.

Bernstein: Okay, but you've got the patent in front of you?

Becker: I don't. I don't, but I can get it.

Bernstein: Okay, well, let's do that.

Becker: Okay. I'll need a minute. I've got to go over the Doug's office.

Bernstein: Okay.

Armstrong: The fax is on its way to you now.

Becker: It's on the way to me?

Armstrong: Yeah.

Becker: Okay, then I'm going to put you guys on hold...

Armstrong: It's not done yet.

Becker: Well, I've got to go upstairs and get it, so hold on.

Armstrong: Never a dull moment.

Utley: They didn't put...they didn't put...

Bernstein: <Inaudible comment.>

Utley: And I did it again on Wednesday night.

Bernstein: And he said to me all these changes were in when I went through them at 11:15 at night with them. That all the math has been changed. I was looking at him and said these haven't been changed. He said, "No, I'm working on a copy that's been changed. I'm going to send it to Brian, and sign off..." So, well, now, again, we're back at this same thing. How do we change things? What effects does it have on us?

Utley: This has no effect. Mathematically, that's...



Lorraine Christine Hoffman, Esq.
Assistant Staff Counsel
The Florida Bar
File No. 2003-51, 109(15C)

S. Bernstein: Were those faxed?

Bernstein: Yeah.

S. Bernstein: Okay. Nine pages.

Utley: But obviously this has an effect.

Bernstein: A huge effect because you have completely altered numbers.

Utley: Well, you could explain it; but the only way you could derive this is by having that be the square root.

Bernstein: But this is wrong that he missed this, and isn't that on your current math? Do you have your sheet that you did...current math...that he said he didn't have, had, whatever? Brian, do you have the patent book?

Utley: Yes.

Bernstein: Okay. I need to borrow that.

Armstrong: I would think that in a patent document being as important to us as it is, there's not an acceptable level of error. It's either got to be all right, or it's not acceptable.

Bernstein: Oh, and that's what we heard from Doug this morning. So, I mean it's hard to fathom this.

S. Bernstein: You know what guys? I don't understand. Why doesn't somebody... take five minutes, and tell me what...because I say it in a meeting with all the lawyers, and...

Bernstein: Here, Dad, let me give you an example. Is 2,560,000 times .8 the same as 2,560,000 times 1.25? Yes or no?

S. Bernstein: I doubt it!



Lorraine Christine Hoffman, Esq.
Assistant Staff Counsel
The Florida Bar
File No. 2003-51, 109(15C)

Bernstein: Okay, well, that's the issue. That's how far off these are.

S. Bernstein: Okay.

Becker: This is Steve. I'm back, and I can't seem to find that file. Doug is out today. You guys may know. So, I don't know how much help I'm going to be.

Bernstein: Okay, well, do you have the fax? Hey, D-Man, you've got the file right there. Just email it to him.

Becker: Here it is. I've got the fax now.

Bernstein: Okay. Steve, Doug also mentioned that you had emailed some correspondence to us that you didn't think the math was right earlier? I have no records of any of that.

Becker: No, what I did was I faxed the draft over on Monday night, which incorporated some additional disclosure that Brian had sent. Basically, it was examples. It had the equations set out for both print film and digital examples, and then he had three examples for print film and one example for digital, and I essentially...I exactly basically cut and pasted that into the application.

Bernstein: Well, the application we got from Doug didn't have any of that.

Becker: I don't really know because at that point Doug was down there with you guys, and I presumed you were reviewing it on like Tuesday and Wednesday. And the Doug said he would take care of just...because we figured there would just be some minor changes after we'd incorporate all of that.

Bernstein: Well, it wasn't incorporated, so there were huge changes.

Becker: Oh.



Lorraine Christine Hoffman, Esq.
Assistant Staff Counsel
The Florida Bar
File No. 2003-51, 109(15C)

Bernstein: And it would have been filed completely wrong had it not been for Jim Armstrong reviewing it. Everybody would have nodded off on this and accepted wrong, completely wrong, filings.

Becker: Maybe he should be part of this conversation.

Bernstein: He's on this conversation.

Becker: Oh, good. Hi, Brian.

Utley: Hi, Steve.

Bernstein: Brian's here and Jim Armstrong's here.

Becker: Okay. Well, the only link we're missing here is Doug because Doug took the last few steps of incorporating comments and actually filing the application on Wednesday.

Bernstein: Hey, E...E-man, forward him a copy of the final draft, would you?

Armstrong: And that, Steve, I think the most important question to have answered is what are our rights and obligation and opportunities to correcting this without any ill effects to us?

Becker: Yeah. There's plenty of opportunity essentially. We can file...if there are substantial errors in the application as it was filed, we can simply file a new application as soon as we get those fixed either on Monday or Tuesday or what have you. The goal of filing on Wednesday was to maintain priority back to the provisional application, which was filed a year ago.

Bernstein: So, did we lose that if they're wrong?

Becker: No, because we can only claim priority back to the extent that the subject matter was originally disclosed in the provisional filing of August 2nd of last year, and none of these equations were filed back then.

Bernstein: But the original process was.



Lorraine Christine Hoffman, Esq.
Assistant Staff Counsel
The Florida Bar
File No. 2003-51, 109(15C)

Becker: Right. And the original process is the [] in the application. We're just talking about the details of the math examples that are in here. So we haven't lost anything.

Bernstein: Will we lose claiming back to the priority of the original provisional? So we did lose something, or am I incorrect in what I'm hearing.

Becker: No, we didn't lose...the original provisional can only provide priority for what was originally disclosed, and the math was not originally disclosed, right?

Bernstein: Well, no, but the math is a subject of the invention, not vice-versa.

Becker: The reason I'm putting the math in there is essentially to provide concrete examples...

Bernstein: Of the invention.

Becker: Right.

Bernstein: But the invention was in there as of the priority date, and we had already talked with Chris Wheeler and everything regarding this. Were you on that conversation?

Becker: I don't remember.

Bernstein: Well, Brian, you were on that conversation. It's the conversation where we were going back to try to get the soonest date on the filing and correcting the provisional to encompass all of these things.

Utley: Well, you can't correct the provisional, but you can...what it does is it claims back for everything that references back to the original, but then incorporates all the new elements to bring it into...to make it into more of a complete statement.

Bernstein: I'm not sure I understand this. It was my understanding that we were going back to Ray [Joa's] patent and fixing it by inserting what we



Lorraine Christine Hoffman, Esq.
Assistant Staff Counsel
The Florida Bar
File No. 2003-51, 109(15C)

A bit further



Lorraine Christine Hoffman, Esq.
Assistant Staff Counsel
The Florida Bar
File No. 2003-51, 109(15C)

priority back to that patent application. So we've preserved that chain of priority.

Armstrong: Are then completely confident that errors that we need to correct right now then are not going to hurt us in any way, shape, or form as being able to claim as part of our invention all of the correct things that we want in there?

S. Bernstein: That's what I heard at that meeting, that we could go back and re-do that at a later date without having any implication.

Bernstein: As long as it wasn't new subject matter.

S. Bernstein: Exactly right. These are just corrections to the...

Bernstein: They're corrections, they're math, whatever.

S. Bernstein: Okay, but we're not saying this is a new way to get to that.

Bernstein: No.

S. Bernstein: Okay, that's what I heard. That's the notes I took. Eliot, you should have that on the tape recorder so that we know that.

Armstrong: Well, we do, and that would also support, I think, another issue, which is that we now have to go through the refiling of something else which was originally corrected several days ago and was somehow ignored so that this whole refiling shouldn't even cost us anything.

Bernstein: Well, and beyond that, Doug <sic>, what I'd like to really get down to is a letter from you, in writing, explaining all of my, you know, both from the Ray [Joa] patent forward, and I think you need to talk to Doug about it, of what our potential pitfalls are here with these filing errors, what our potential pitfalls are, what it caused to happen with that priority, priority equals, and if there's any harm to us. Because we keep just slipping back by these things. This



Lorraine Christine Hoffman, Esq.
Assistant Staff Counsel
The Florida Bar
File No. 2003-51, 109(15C)

should have been right. I mean, we have well documented, and Brian's well documented, that these changes were sent, and now we've missed a priority claim to that by not being able to go back and change our last filing. I need to know the liability here.

Becker: You know, I was not there on Wednesday night. Brian talked to Doug on this and then made final changes, and then...

Utley: Yeah, Doug sent me a next-to-last copy, which I went through and there were a number of errors—I have my notes on each one of those at home—and then I reviewed each one of those with Doug, agreed on what they were, and then Doug was going to send me the last copy, which apparently he didn't because I never received it. At that point in time, it was, I guess, about 11:30 or 11:45 our time.

Bernstein: And these were also discussed in great length with him for a whole day on the phone.

S. Bernstein: Yes, well, how about in the...

Bernstein: No, no, Dad, this is separate. But at great length this was discussed, every one of these changes.

Becker: The changes you sent me here, is this Brian's handwriting?

Utley: No, some of it isn't correct.

Bernstein: Well, let's go through it because I'd like to...

Armstrong: Yeah, let's go through it.

Becker: I don't know if that's going to help that much because it's a question of what actually was filed and whether it incorporated the changes that Brian asked for the last minute.

Bernstein: It didn't.

Armstrong: We know that. This is what was filed.



Lorraine Christine Hoffman, Esq.
Assistant Staff Counsel
The Florida Bar
File No. 2003-51, 109(15C)

Becker: Brian, didn't you just say that Doug didn't send you the final draft of what was filed?

Bernstein: He did it the next day.

Becker: Oh, he did the next day?

Armstrong: Yeah, Jim, can you forward that to Steve real quick?

Armstrong: What?

Bernstein: Email it to him...the final draft?

Armstrong: Yeah.

Becker: Well, I'm not going to question...

Bernstein: Okay, but we need to go through and get the changes acknowledged, accepted, have you put it into the next whatever you're going to do to solve this, with a letter explaining what we've lost here.

Becker: All right.

Bernstein: Okay. Any liability, potential liability where we're exposed to from this.

Becker: Oh, I wouldn't worry about it. You guys are making a mountain...

Bernstein: Well, you know, I gotta tell you, I worry a lot about it from what Doug told us. So, you know what I mean? You tell me not to worry, but then you tell me it's very important that we're accurate in this filing; and then we're very inaccurate in the filing, and then we're not supposed to worry. I'll feel much better not worrying with a letter from you explaining why I shouldn't worry.

Armstrong: Steve, what's at your email?

Becker: Sbecker@folevlaw.com



Lorraine Christine Hoffman, Esq.
Assistant Staff Counsel
The Florida Bar
File No. 2003-51, 109(15C)

Armstrong: Sbecker?

Becker: Yeah, "S" as in Steven, "becker."

Armstrong: Got it.

Bernstein: Okay. Let's just go through this with you, Steve, so we can get the next step done.

Becker: All right.

Bernstein: Which is correcting the issues. Are you with us on page 13?

Becker: Right.

Bernstein: Okay. Jim?

Armstrong: On page 13, line 19, the expression of VWH should follow the way we express it in our definitions, which is VIH. Even though the two are equal, let's just follow the way that we have it expressed in our definitions on page 12.

Becker: Oh, I see. Okay.

Armstrong: Then on line 23, each of those expressions is not congruent with the way we've defined them. Despite the fact that we arrive at the same results, it doesn't apply the formula in exactly the same way. So for a reader, it ought to be the same. So for line 23, it should be the "square root of 2,560,000 times 1.25."

Becker: All right.

Armstrong: Okay. Not "2560 divided by .8."

Becker: Okay.

Armstrong: On line 24, it ought to be "1789 divided by 1.25."

Becker: I see. Okay.



Lorraine Christine Hoffman, Esq.
Assistant Staff Counsel
The Florida Bar
File No. 2003-51, 109(15C)

Armstrong: Then on line 25, it ought to be "1441 divided by 4." Again, the results are the same; the expressions are not.

Utley: No, that last one, Jim, it's correct.

Armstrong: It's what?

Utley: The scan density is 1789 divided by 5.

Armstrong: Okay, hold on. Scan density is defined by us as being...where the heck is it...oh, it's right up above..."target image height..." right up above on line 7..."minimum scan density is target image height," which in this case we just defined to be 1431...

Utley: Where are you reading from?

Armstrong: Line 7 of the same page. Line 7, page 13. So target image height is 1431 divided by the source image height, which is 4, so it should be 1431 divided by 4.

Utley: Well, the...I guess that that equation, "MSD equals TIH/SIH," did not come from my documentation.

Becker: Hold on, let me look at this documentation. I've got it right here, too.

Bernstein: Well, Steve, you have copies of this, too, that were sent to you...

Becker: Right.

Bernstein: ...of what Brian's looking at, several days ago. So how isn't this stuff flowing forward into the patents, especially when we pointed it out two times before filing? I mean, I'm just dumbfounded at this.

Utley: There was a change, Steve, which you were not involved...



Lorraine Christine Hoffman, Esq.
Assistant Staff Counsel
The Florida Bar
File No. 2003-51, 109(15C)

Becker: The proper equations, that wasn't there the last night when the last changes were put in, so I can't really speak to it.

Bernstein: No, but he sent you his changes several days ago.

Utley: Steve, there was a change that we decided on on Wednesday afternoon, which was to reflect aspect ratio as width divided by height, which I made, and that was created by the desire to reflect aspect ratio the way that displays are expressed as opposed to the way photographic images are expressed. Photographic images are expressed the opposite way, and that's the way the documentation had been originally prepared. But it was thought that it was perhaps more consistent with current technology to express it the way that displays are expressed. So I went through and changed...

Becker: You mean from that change in [invention? convention?]?

Utley: Yes. So that caused the equations to be reconstructed to reflect the inverse of what was there before because the affect ratio now is inverted.

Becker: I see.

Utley: And what happened was Doug apparently did not pick up all of those changes, even though I went through them very methodically the last thing Wednesday night when he sent me his almost-final draft.

Becker: I see.

Utley: And, Jim, just for your edification, that also affected the MSD shifting from a height to a width orientation. The number is the same, but it changed it from a height to a width.

Armstrong: So what's the correct formula for MSD?

Utley: It's TIW/SIW.



Lorraine Christine Hoffman, Esq.
Assistant Staff Counsel
The Florida Bar
File No. 2003-51, 109(15C)

Armstrong: Okay.

Bernstein: So, you made this change with Doug, and it's still wrong in the patent?

S. Bernstein: I'm a little concerned about the proficiency of the legal aspect of this. We sat there for hours, and then Brian stayed late into the night with this guy, and then he comes back and we don't file it right anyway? It seems like there's something wrong here. I mean, ...

Bernstein: I mean this is, yeah...

S. Bernstein: I mean, I'm just budding in because I have little or no knowledge as to what the numbers mean, I'm just listening to a conversation in which I'm hearing is that after four or five hours in a room locked together with lawyers and everybody else, we reach an agreement that those changes will be made. No, my understanding is Brian stayed and made those changes, and then the lawyer didn't file the changes? What's the sense of that?

Bernstein: These are good points. Let's move forward, Jim.

S. Bernstein: These are points that have to go back to stockholders with money invested.

Bernstein: That's why I've asked Steve to send us a letter of what's happening, what our exposure is, by Monday or Tuesday, explaining how this didn't occur, get in, and what we're going to do to resolve it, and what that resolve initiates in the chain of events.

S. Bernstein: Well, the other side of it is this. If after all of this precaution has been taken—and Brian, you can correct me if you think different—but after all of this precaution has been taken, it appears that the fallacy of worrying about it ever gets accomplished. Brian stays, everybody works on it, it's still filed wrong. Now what if Jim Armstrong hadn't caught it. Brian was on a plane today...



Lorraine Christine Hoffman, Esq.
Assistant Staff Counsel
The Florida Bar
File No. 2003-51, 109(15C)

Bernstein: Then none of Brian's changes even sent several days ago even would have been in there. Math would have been wrong, equations would have been wrong, verbiage would have been wrong.

S. Bernstein: Am I right, Brian, in having this concern?

Utley: Well, yeah, obviously it's clearly a major concern because there's nothing more disciplined than the mathematical expressions.

S. Bernstein: And you're comfortable that what you did, even if some of them were wrong, that we could have later corrected...

Bernstein: No, Dad, we sat here with Brian and Jim and Doug, and we went through it, and we all agreed it was right, and those changes do not appear.

Utley: No, we...

S. Bernstein: That makes me very nervous. Well, it makes me nervous to the extent that are all of the other patents done right?

Bernstein: Well, that's what I'm...I'm going to start having somebody review all of this. I mean, obviously there's...it opens up a whole can of worms.

S. Bernstein: Well, the other thing that I heard was—and not negatively or anything else—but I heard that perhaps Ray [Joa] did this work and he was either concerned about it being a bit sloppy, blah, blah, blah, blah. What is the excuse for this law firm?

Bernstein: Well, let them write us what's happened here. I mean, I definitely need to see on paper, Steve, some kind of report on this. That it describes what occurred, why it's not reflected in the patent filings, and what our exposures are, and that'll tell us what we're dealing with in firm, etc., liabilities. I mean, we don't know that.



Lorraine Christine Hoffman, Esq.
Assistant Staff Counsel
The Florida Bar
File No. 2003-51, 109(15C)

Armstrong: We should continue to look at the changes so that he's copy that reflects everything.

S. Bernstein: Well, even if there is no liability, what I'm still concerned about, even if it can be corrected, it's the exact same position—Brian, am I right?—that we found ourselves in with the last lawyer who did it. Okay, thank God we can make changes, but that isn't the answer. Why not just get it right, get it filed...

Bernstein: No, don't just say thank God we can make changes, Dad, because all of that brings additional liability to you. You miss dates, you miss claiming, you miss this and that—words that are very tricky and confusing, and only these guys can understand. So that's why I need it to be put in writing so I can have it analyzed...

S. Bernstein: Absolutely, I want it definitely, because I need to take it...you know, I need to have board member approval...

Bernstein: Oh, I think our board is going to be disastrous with this stuff about several things when we take this to them. And we need to know from the Ray [Joa} level to the Foley-[Larver] level, how this is going to be cleared up and what the problems were that occurred.

S. Bernstein: Okay, let's get that part in process; and it's unfortunate that Doug's not here because maybe it's something he could explain.

Bernstein: No, I talked to him this morning; and as a matter of fact, he said Steve had the math from Brian days before and by the time he got it, he thought it was all input correctly, and that was his excuse.

S. Bernstein: Well, what was he doing here with Brian?

Bernstein: Well, then we spent a whole day with him correcting it all so that it was right; and then by filing time, none of it was right. So, let's



Lorraine Christine Hoffman, Esq.
Assistant Staff Counsel
The Florida Bar
File No. 2003-51, 109(15C)

go forward. Let's just stay on track. We'll deal with all of these issues on Monday.

Utley: I just say one thing. The most important part of the math is all of the definitions. The examples are examples; but the most important part of the math are the definitions.

Becker: Okay, are those right?

Armstrong: No. Well, there's one that's not, which is []. Line 7 of page 13...

Bernstein: Is wrong.

Armstrong: Is wrong. It should read...

Bernstein: ..."[] equals TIW/SIW."

Utley: They are mathematically equal. Both will give the same results. It's a consistency question as opposed to an accuracy question.

S. Bernstein: And for a reader, it would probably be easier to be consistent.

Utley: Absolutely.

S. Bernstein: That's what we want. As long as we're spending all of this money and everybody's devoting their time to it, we want it to right—as right as you can possibly get it at any rate.

Bernstein: Okay, Dad, let's move forward.

Armstrong: That changes one thing on line 25. The expression on line 25 is now correct as it was typed, so scratch out my handwriting. Okay? All the other corrections stand as I explained them earlier. Now, on the last line of this page, that should read: "480 X 320."

Utley: That's correct.

Armstrong: Okay. Then on line 6 of page 14, I think we should consistently state which is width and



Lorraine Christine Hoffman, Esq.
Assistant Staff Counsel
The Florida Bar
File No. 2003-51, 109(15C)

which number is height because it's such an important distinction in the calculations. We did it on the previous example, but not on this one.

Utley: And that is what we had agreed upon on Wednesday afternoon.

Armstrong: Okay. Line 17, again we're just missing that square root symbol in order to make that equation work. Without the square root, it's millions instead of thousands. Now, in line 19, I had originally indicated this was correct; it's now incorrect because of our change in the formula for the density for the maximum scan density.

Bernstein: Steve, are you getting all of these?

Becker: Yep.

Armstrong: This should now read in line 19: "1789 divided by 5 equals 358."

Becker: "1789 divided by 5 equals 358?"

Armstrong: Yes.

Becker: All right.

S. Bernstein: Steve, I have a question to ask you.

Becker: Yes.

S. Bernstein: When Jim or Brian or anybody gives you these numbers, are they checked out by anybody, or do you just copy what we say and that's it?

Bernstein: No, they definitely don't copy what we say. That's an initial problem here, Dad.

S. Bernstein: Okay, I don't mean to be sarcastic.

Bernstein: No, but they would normally as mathematical people add up the equations.

S. Bernstein: Yeah, because your partner was telling me that most patent lawyers are engineers, which would



Lorraine Christine Hoffman, Esq.
Assistant Staff Counsel
The Florida Bar
File No. 2003-51, 109(15C)

lead me to believe that somebody would say, "well, I better check the math to make sure that guys who are not engineers know what the hell they're talking about." Is that done by your firm, or is it just accepted as gospel what we give you?

Becker: We don't have engineers or technical people check the math that you provide us.

S. Bernstein: Okay, so what we provide you, then, we live and die by?

Becker: Okay. Your job is to get that right.

Bernstein: Right, but what we did give you, you didn't provide in the patent.

S. Bernstein: Okay, we're trying to say the same thing.

Bernstein: Okay.

Armstrong: Let's just get it right. At this point we're only interested in getting it right. Line 27, that should be "36H" for the height.

Bernstein: Which page?

Armstrong: Line 14, third-to-last line of the page.

Bernstein: Okay.

Armstrong: Now we're onto page 15. Again, we just need that square root symbol as indicated there.

Becker: Okay.

Armstrong: Then there is nothing on the next few pages until we get to page 18, this is an important omission for our calculation standpoint, but we need that square root symbol.

Becker: Okay.

Armstrong: Then I'm going to skip for a second this discussion on minimum scan density here because I



Lorraine Christine Hoffman, Esq.
Assistant Staff Counsel
The Florida Bar
File No. 2003-51, 109(15C)

want to talk to...go with Brian's comments, too, but on line 10, the correct figure is "1.33 equals 1.33."

Becker: Okay.

Utley: Yeah, that wasn't picked up from the other...from above, the aspect ratio.

Armstrong: Line 15, the square root symbol again is missing from that equation. And then finally, I don't see why, in this example, or any digital example where we have no scanning to do, why we should even include any reference to minimum scan density because the only application of scanning in a digital world is if we were to print a digital photograph and later scan it, in which case we'd follow the print formulas, not the digital formulas. So, my suggestion here is that we change the sentence, beginning on line one, to end after the word "dimensions"...actually, strike the words "and minimum scan density" and also to eliminate line 23. Do you agree, Brian, that there's no reason to have that there?

Utley: It certainly doesn't anything. It doesn't subtract anything.

Armstrong: It just added confusion to me as a reader when I thought, "How do I calculate that?" and then realized it's not...we're not scanning anyway. Why ask someone to determine something that is not included as a step of the process? So I think if everyone agrees, we should strike the words "...and minimum scan density" in line 1 and 2...

Utley: No, what I would do, I wouldn't do that. What I would do is simply say, "...image size and dimensions" and then add a new sentence which says, "Minimum scan density is not required since we are dealing with a digital image."

Armstrong: That's fine, too. Then let's strike line 23.

Utley: No, I'd leave that in.



Lorraine Christine Hoffman, Esq.
Assistant Staff Counsel
The Florida Bar
File No. 2003-51, 109(15C)

Armstrong: It's redundant, but that's okay. Do you see any other problems with the formulas? Did you review all of this again today, Brian?

Utley: I've not reviewed anything today. I wasn't aware of the problem until about three minutes ago.

Armstrong: Okay. So that covers my comments on that.

Bernstein: And, Steve, do me a favor. When you guys draft this letter, draft it to Si and Brian. Okay? I'd like to be cc:'d on...and by the way, I'd like to be cc:'d on any correspondence of anybody to do with the patents.

Becker: Okay.

Bernstein: One last thing. Doug mentioned that you had a file from Brian, a spreadsheet that part of the spreadsheet matter is not incorporated in here. He didn't know why...he couldn't explain why. I was wondering what that matter is, and where is it? Are you aware of that? Because he referred to you.

Becker: Did he?

Bernstein: Yes.

Utley: That's probably the image sizing spreadsheet.

Becker: Image sizing?

Utley: Yeah, I sent you two files on Monday.

Becker: Okay. Actually, you sent three all together. Oh, you sent three emails, and then the last one had two of them.

Utley: Right, the last one had two files: both the image sizing and the process.

Becker: Oh, you're got the macro, and then you've also got the description of the math. Now, what did you want included that wasn't?



Lorraine Christine Hoffman, Esq.
Assistant Staff Counsel
The Florida Bar
File No. 2003-51, 109(15C)

Bernstein: Well, Doug said it should have been included, but it wasn't...the rest of that sheet.

Becker: What?

Bernstein: I don't know. Whichever half's missing.

Armstrong: Hold on one second...I don't want to confuse Steve. We do not want you to cut and paste out of those documents into the patent filing. Those documents do not reflect the way we want to express the math.

Bernstein: Right, but we might want them in there, B, correctly.

Armstrong: What?

Bernstein: We might want them...

Armstrong: They're not in there correctly. We just went through it. It's now correct. If he employs all of the changes we just all agreed to...

Bernstein: No, but there's another sheet that's not reflected here.

Armstrong: Well, yes, I do want to talk about that. The macro, right?

Bernstein: Right. Can you forward that file to us—the Excel sheet—to Jim, me.

Armstrong: Just have Steve forwarded the whole email back to you.

Bernstein: Well, he doesn't have it in front of him, and Brian's got it right here.

Utley: No, I sent it to you. You were copied on it.

Bernstein: Okay. Let's just get the most up to date...any changes.



Lorraine Christine Hoffman, Esq.
Assistant Staff Counsel
The Florida Bar
File No. 2003-51, 109(15C)

Becker: Yeah, Brian, remember, we made a decision not to file the claims directed to your macro—we made that decision last...a week before the...

Bernstein: Why?

Becker: Because it was going to involve some additional work, and we didn't have time at that point; and it was all new matter that wasn't going to claim priority to anything, so...

Bernstein: Well, what's new matter? If the math is part of describing the invention, then it's not new matter, according to what Doug's told me four times now.

Becker: Well, Eliot, as you recall, you always have to look at the claims of the application, and that defines the scope of your protection. The claims will also define...also have to be supported by specifications. We were going to direct claims to the idea of using...of having a macro program, which is useful as a tool, to do these calculations in a rather simple process.

Bernstein: Okay, that's fine if you want to just claim a macro. That does it as a simplified process and add that as an additional patent for us, but the underlying math of it should all be applicable to the invention since it's just derived off the invention.

Becker: Yeah, math...

Bernstein: So it's not new matter, it's just an understanding of the matter. I mean, I swear we went through this four times the other day with that conclusion.

Becker: There are two files that Brian sent me. One of them was an Excel spreadsheet having six pages, and all of that material was included in the application in pretty much cut-and-paste format. His pages 2, 3, 4, and 6 were the examples, which I just cut and pasted as soon as I got them from



Lorraine Christine Hoffman, Esq.
Assistant Staff Counsel
The Florida Bar
File No. 2003-51, 109(15C)

Brian because they defined it all very particularly.

Bernstein: Okay, now you need to get back your record of that because 2, 3, 4, 5, and 6 that Brian is sitting here showing me, were never in these patents yesterday. So cutting and paste, you must have put them in the wrong document.

Utley: Those are the examples.

Bernstein: But those weren't...that's not what ended up in there.

Utley: They pulled these pictures out and put them as a figure sheet on the back, and then re-entered...

Bernstein: Wrong math.

Utley: ...the formulas in the body of the...

Armstrong: Hey, right. B, are those images...are you looking at the figures? Are all of these figures in the patent application.

Utley: We should be on figure 7.

Bernstein: Steve, figure 7?

Becker: Okay.

Bernstein: Are you looking at it?

Becker: Not in front of me, but I recall writing it.

Bernstein: Jim, figure 7, what do you see?

Armstrong: I don't have a figure 7...because that was part of...that didn't come in the patent application, but [].

Bernstein: It's not part of that final patent?

Armstrong: I don't know about that, but it didn't come as part of that Word document.



Lorraine Christine Hoffman, Esq.
Assistant Staff Counsel
The Florida Bar
File No. 2003-51, 109(15C)

Bernstein: That's supposed to be the final revision of the patent.

Becker: We have to scan the drawings into a Word document; so if you just mailed the Word document, you probably didn't get any figures yet. Probably the figures were left off of that.

Bernstein: Okay, do you have your patent application?

Armstrong: I've got the one we reviewed on Tuesday.

Bernstein: And what's in there?

Armstrong: All the figures.

Bernstein: Right or wrong?

Armstrong: You know, I don't know. I didn't...Brian, was figure 7 changed at all with the restatement of our aspect ratio?

Utley: There were some additions that I made for clarification purposes. If you look at the first page of the imaging process, where it says, the third box down, it says "viewing image," I inserted "SIR less than DWR" to tie it to the equation above it. And then in the one, the bottom, it has the expression "SIR greater than BWR," again, tie it to the equation above it.

Armstrong: Yeah, because those two don't have a distinction, figure 7 as it is now.

Utley: Right. So that simply ties the image to the equation.

Armstrong: So do they have...have you sent them an updated amendment?

Utley: Yeah, that went out late Wednesday afternoon.

Armstrong: Okay, we've just got to make sure that the corrected figure 7...

Bernstein: Steve, can you fax us the file patent?



Lorraine Christine Hoffman, Esq.
Assistant Staff Counsel
The Florida Bar
File No. 2003-51, 109(15C)

Becker: No, I can't find it. I guess Doug took care of this from...

Bernstein: Does his secretary have a copy?

Becker: ...Monday night on. I spoke with her, and she wasn't clear...she wasn't able to find it.

Bernstein: Do we have a filed patent?

Becker: How certain would you like me to answer that question? I mean, Doug sent me an email saying we filed the patent.

Bernstein: Well, what he sent me that he said he filed is missing the diagrams. So, I have a final patent document missing...

S. Bernstein: When is Doug available?

Bernstein: Yeah, does he got a cell phone or something?

Becker: I don't know. I don't know. Maybe I can help clarify this...I mean, Eliot, you sound like you're really upset at us.

Bernstein: You know, I'm not a person to get upset until I see that I spend a lot hours going through this, Brian spends a lot of hours, we make all of these global changes...

Becker: Eliot, I've heard that a couple times already. Let me try to explain a little bit about patent law and maybe help everyone understand what has or has not happened. Okay, there's a lot of rhetoric being thrown on there, but there's...

Bernstein: Yeah, because we're blind.

Becker: I don't think all of it has a lot of basis in patent law.

S. Bernstein: That's good to hear, so let's hear that.

Becker: Okay, and Si, I thought you in particular might be interested to hear that.



Lorraine Christine Hoffman, Esq.
Assistant Staff Counsel
The Florida Bar
File No. 2003-51, 109(15C)

Armstrong: You don't have it, Brian.

S. Bernstein: Because I don't have 22.

Armstrong: Want me to fax it... email it to you?

S. Bernstein: No, that's okay, he's going to explain it to me. I want to see if I can't understand this.

Becker: Sure. It's very sort claims, seven lines long. It actually defines the scope of the patent protection that we are trying to obtain in this filing.

Armstrong: Who are we waiting for, Eliot?

Becker: I think so.

Bernstein: I'm up front. We're waiting for Brian again.

Becker: Let me know when you're ready.

Bernstein: Okay, Steve, Brian stepped out for a minute, but I still want to address this issue. We invent something. I hire a mathematician. The mathematician solves the X, Y, and Z of the invention. Does he claim a new patent for himself?

Becker: Probably not. [Inventorship] typically follows with the invention. If somebody else figures out how it was done, generally speaking that would.

Bernstein: Well, I want to be very color on this because Doug's thinking...I don't even know if then the next statement is correct or incorrect, but if a macro was created using the math that comes from the invention, where does it follow? Brian, I just asked him, if I hired a mathematician to do the math, put all of this into a thing, where does this follow. He says the invention, the inventor, etc. The guy you hired to do math wouldn't claim a new patent or a new invention, which is confusing to me because Doug now, as of this morning, told me that you're planning on



Lorraine Christine Hoffman, Esq.
Assistant Staff Counsel
The Florida Bar
File No. 2003-51, 109(15C)

filing a separate patent as inventor of a macro that just spawns off the math entitled to this invention. So I'm confused, and I want to be very specific on this of what our strategy is here on all of these peripheral pieces.

<End Side 1; begin Side 2>

Bernstein: Why don't you explain that to me again.

Becker: Can we go ahead with describing the claims?

Bernstein: Well, do you want to just finish that real quick, and then we'll go right back to the claims?

Becker: Okay, now what was the question you posed me, Eliot?

Bernstein: I hired a mathematician to solve for what I did. He comes up with an equation. Where does that equation belong? Does it belong filed as another patent? What's the inventorship, so to speak? And then, I design from that math a macro that solves that math with input formula. How should we be protecting that the whole way through, because I seem to be very confused about what I'm being told each day.

S. Bernstein: Okay, let him answer the question.

Becker: Inventorship follows whoever conceived the invention as claimed, and that's why the claim is so important because when you set forth in your claim what it exactly is that you're claiming, you have to ask who conceived of that idea—who was the first one to come up with it. So, typically if somebody really reduces your idea to equations that describe why it works or how it works, typically they would not be named as a co-inventor because they really didn't invent the idea. Now if you wanted to claim a macro which has user-input displays for receiving certain data that can be used by, say, a technician to determine the scan density of a print film image that would allow for the desired enlargement ratios and the desired target image size, that kind of is a separate idea, and that's why we



Lorraine Christine Hoffman, Esq.
Assistant Staff Counsel
The Florida Bar
File No. 2003-51, 109(15C)

thought it would be useful to claim that as a tool as well.

Bernstein: Okay, and I understand that part. I don't mind claiming that all day long.

Becker: Brian really was the one that built that and came up with it. It's based on principles that you learned, you know, a few years ago that maybe you didn't understand the math behind them, but certainly, I would think, be named an inventor on that.

Utley: I think that would probably claim both myself as it relates to both aspects.

Becker: Right. But the important thing with the patent office is that it is...the patent office realizes that it is a bit of a grey issue in terms of who conceived what, so the important thing is not to have any deceptive intent.

S. Bernstein: I think the most important thing is the distinction between inventorship and ownership. As I understand, all of this, every one of the patents that we have filed, all rights, title, and interests are iviewit's, regardless of who the author/inventor is; and any revenue stream derived therefrom are iviewit's, and that's the important thing. Is that true, despite and in light of the [__]? My very next question, because we could put anybody as an inventor; but as long as that doesn't entitle them to a disproportionate share of any revenues derived therefrom, then I don't care.

Becker: Yeah, inventorship or ownership initially vests in the inventor or inventors who are named in the application; but typically, inventors are under some obligation to assign to a corporate entity, either written or by cause of their employment—and you can get into the issues of shop right...you know, if somebody invented something on the corporate time and then went and...you know, it wasn't really part of his job description, I know this issue's going to be a



Lorraine Christine Hoffman, Esq.
Assistant Staff Counsel
The Florida Bar
File No. 2003-51, 109(15C)

little more tricky. But I think in this case...what we do typically as a practice to confirm ownership is to have the inventors sign a written assignment document over to whichever corporate entity they want to...

S. Bernstein: But haven't we followed that?

Becker: We've got those documents. I don't think we have them all signed and filed yet.

S. Bernstein: Let's get them.

Utley: Well, Doug was doing that on Tuesday while he was here.

Becker: Okay. Did you do some signing of documents, Jim and Eliot?

Bernstein: Yeah. Right.

Becker: Okay, so that's in process.

Bernstein: Okay, and wasn't really the intent of my question. The intent of my question is to define, for my understanding, what should claim back to Ray [Joa's] patent, and that means that everything other than a macro shell should define back to the original patent and be filed, corrected, amended, however we get it in to the original patent documents since none of it's new matter, it's just an explanation mathematically on every equation of what happens.

S. Bernstein: That's what I heard at the meeting.

Bernstein: And that is exactly what I've heard, repeated; and then this morning, it was completely opposite, and yesterday is was a little opposite—a little—and, you know, I've become very confused about which strategy we're taking, which road, because we decide something, and then it's changed, and we're doing something else, and I'm completely lost.

Becker: I think I can make this very clear for you if you'll give me an opportunity.



Lorraine Christine Hoffman, Esq.
Assistant Staff Counsel
The Florida Bar
File No. 2003-51, 109(15C)

And further



Lorraine Christine Hoffman, Esq.
Assistant Staff Counsel
The Florida Bar
File No. 2003-51, 109(15C)

Bernstein: Okay, hold on one second. Steve?

Becker: Yeah.

Bernstein: When I look at Ray's claim one, "What is claimed: An apparatus for producing a digital image comprising a device for generating a digital signal file from a print film image and a processor for processing said digital signal file and for generating an image file wherein said processor generates a first signal file from said digital signal file, and further wherein said processor processes said first signal file and generates set image file."

Becker: Okay.

Bernstein: Okay, we all agreed that that is completely insane...to describe anything about our invention...whatever.

Becker: I know it's all completely insane; but I think that with the claim that we drafted, ...

Bernstein: Yeah, he missed the point. Okay. Well, then, the claim we drafted, this was my question. It should be right here, in this claim, in the patent he filed to date back as far as I can to protect our dates, should be changed to the claim we just created.

Becker: Oh, no, this application died on Wednesday, and it doesn't proceed to a patent. A provisional application...

Bernstein: No, no, this isn't provisional. This is a filed patent. I'm doing one.

Utley: This is the one that was filed March 24th.

Becker: Oh, okay.

Bernstein: By Ray [Joa].

Utley: So this was the PCT filing on March 24th.

Becker: Okay, thanks.



Lorraine Christine Hoffman, Esq.
Assistant Staff Counsel
The Florida Bar
File No. 2003-51, 109(15C)

Bernstein: And my question is shouldn't the claims in this patent we just filed be exactly, if not identical, to the one...or should they be transposed to Ray [Joa's]? And it was my understanding from Doug that for speed and if the patent gets through, etc., that we would rather have it be based on that first patent filing.

Becker: That could be a recommended course of action.

Bernstein: And this is going to get dejected.

Utley: What we discussed on Tuesday...no, on Monday afternoon, was that one of our action items was to go back and review the March 24th filing and decide exactly how we were going to integrate into that filing the claims that should be in there vis-à-vis the specification.

Becker: Okay.

Utley: That was one of the action items that we covered on Monday afternoon.

Bernstein: And now my question further goes to say that once we amend the claims, is there any way to amend the body?

Becker: No.

Bernstein: Even if we're not adding new subject matter?

Becker: You can amend the body if you don't add new subject matter.

Bernstein: Okay, so we can fix Ray's mess.

Becker: You can't add what we added in this application.

Bernstein: Which part? The math is just a description of the old matter, so therefore we should be able to add it.

Becker: It's not supported. It's not suggested in the prior applications.



Lorraine Christine Hoffman, Esq.
Assistant Staff Counsel
The Florida Bar
File No. 2003-51, 109(15C)

Bernstein: Oh, it's all suggested because by the nature of the invention it's suggested.

Becker: I think the patent office will never allow us to add all of that matter into the application.

Bernstein: Okay, but we should add as much matter as we feel comfortable with to buff up Ray's original filing.

Becker: Sometimes if you change a word or a sentence in a specification...

Bernstein: Yeah?

Becker: The examiner will outright reject it for new matter.

Bernstein: Well, who cares? He's going to reject this for insanity in the first place. I mean, he's going to reject this for "what did you patent? Nothing?"

S. Bernstein: If I'm hearing Steve right, there's very little we can do to change the language and content of that particular...

Bernstein: No, you're not hearing him right because he just said you could change all of the claims whenever you want as long as the examiner hasn't approved them. And right now before the examiner starts approving...looking at this and saying it's nonsense, I'd rather get the right stuff in there. Now, we can get most of this stuff in there, albeit I'm going to need good argumentation as to why we can't get it all in there.

S. Bernstein: Steve, is that correct?

Becker: We can change the scope of the claims of the prior application...I mean, that's a good action item, a good thing to do. You know, as I mentioned, it's unlikely we'll be able to change



Lorraine Christine Hoffman, Esq.
Assistant Staff Counsel
The Florida Bar
File No. 2003-51, 109(15C)

the specification substantially; and if we don't quite...

Bernstein: Well, we should throw in the word "zoom" if we can.

Becker: At some point it becomes a question of language and what language you've used. If we come in and start saying, "Well, what we really were talking about is zoom and pan," Yeah, it's possible we could get some of those arguments through the examiner, but...

Bernstein: Well, we sure as shit should try.

Utley: Well, it looks like Ray took all of this out of here.

Becker: It's not as critical as getting one good filing on like we did on Wednesday.

S. Bernstein: Yeah, but the date's what's important.

Bernstein: Right.

S. Bernstein: If this March one...we have one good filing, but it's dated August 2nd. That's the difference.

Becker: But it claims priority back to...

Bernstein: The original provisional.

Becker: The original provisional, which is before this date, again to the extent that it's...

Bernstein: Right, and that's the strategy I have been hearing is the correct approach here, is that we should be cleaning up Ray's filed patent as best as we can without adding subject matter—and I don't think we really have any new subject matter other than a macro shell to re-widget our math, which is okay, we'll leave that out. But I definitely want the underlying math, because that's just not new subject matter, that's just old subject matter defined, and try to get as much of this in that examiner's hands as fast as



Lorraine Christine Hoffman, Esq.
Assistant Staff Counsel
The Florida Bar
File No. 2003-51, 109(15C)

we can because that is our first patent and we'd like it to approve. And then you know what? Leave the macro in this one, and then you've got a reason that you've got new matter in this one that doesn't conflict with your old matter. I mean, the math, I sat through with Doug, went through this with Chris Wheeler, my father, I heard all of those things, and then I'm hearing that that's not our strategy. So I just want to be very specific on this so that we get that completed in time. I know there are issues to timing, etc., that we don't want to waste.

Now, I'm also confused of how we particularly predicted our date as well on when this was first exhibited. According to my last notes of when you guys were down here originally, we kind of went through a timeline; and that timeline has now been changed to September, when, in fact, we felt it was more like April or something as the first commercial advantage. Now Doug's talking to me about September dates, and I can list you fifty things that occur before then that will be detrimental. As a matter of fact, the first one really being something like 8/10, which only gives us six days, if my numbers are correct. We signed a license contract with [Centrec? Centrack?] to use and distribute your product. So that's well before 9/1; and these are some real critical things that depend on that date, if I'm not mistaken.

Utley: What contract?

Bernstein: [Centrec? Centrack?]. The license agreement was signed on 8/10.

Utley: The only thing we signed was a demo.

Bernstein: A demo license, yeah. Well, you were putting it up to commercialize on their site—on a public site.

Utley: But there was no charge.



Lorraine Christine Hoffman, Esq.
Assistant Staff Counsel
The Florida Bar
File No. 2003-51, 109(15C)

Later in the call



Lorraine Christine Hoffman, Esq.
Assistant Staff Counsel
The Florida Bar
File No. 2003-51, 109(15C)

Bernstein: Great. Let's get those out to Jim real quick. I'd like him reviewing those by the 8/10 date. Any changes, we're obviously going to try to revert to keep our 8/10 day as our commercialization day, giving us a little buffer if we're wrong.

Becker: All right.

Bernstein: You know what I mean? I mean because we don't know how people will interpret in the end what [Centrec? Centrack?] was, but to beat it would definitely give us a greater argument.

Becker: Yep.

Bernstein: So, all right, we'll pick this up...you're going to make those changes on this patent, correct?

Becker: I'm going to wait until I speak with Doug.

Bernstein: Okay, great.

Becker: To find out what was actually filed, and then we'll decide how best to proceed with amending that.

Armstrong: Steve, one more clarification. Did you say we have or have not had successful closure on the signing over of inventors' patents to the company?

Becker: I can't speak to that; Doug is working on that.

Armstrong: Okay, will you put that in our list of things to do...or your strategy that that gets completed?

Becker: Yeah.

Bernstein: Yeah, and B, I just signed as well as Brian and Jude and everybody. It's a large, thick document, so Doug should have an update, Steve, as to what is exactly signed. I think it was everything, correct? And we've got everybody here.

Armstrong: I've got emails that indicate that that was all done nine months ago.



Lorraine Christine Hoffman, Esq.
Assistant Staff Counsel
The Florida Bar
File No. 2003-51, 109(15C)

Bernstein: No, it was, B, but then we filed patents; and then we thought the past was done, and now these new ones had to be done, so he came here, there was notaries here...it was, you know, it was a lot, but let's get an update on it.

Utley: In addition to that, everyone has individually signed a separate agreement with the company, assigning to the company any intellectual property that's created as a result of their employment.

Armstrong: That I know. The key inventions, I just want to see that they've signed over because that's the value of the company right there. That's what I own stock in.

Bernstein: Correct. Okay. So let's get an update, and I think we're pretty close.

Armstrong: Okay.

Becker: Eliot, why don't we go through the list of things that you've asked me to do so we can be perfectly clear on this?

Bernstein: Okay.

Becker: The first is to amend Ray's PCT application, at least the claims, so that we have a good filing there, at least based on whatever Ray has in his specification. That's task #1.

Bernstein: Claims plus any additional language that's not new matter.

Becker: All right.

Bernstein: Okay.

Becker: You want a letter describing the...what was omitted or what was incorrect in this application filed Wednesday and to what extent that may have any bearing on rights.



Lorraine Christine Hoffman, Esq.
Assistant Staff Counsel
The Florida Bar
File No. 2003-51, 109(15C)

Bernstein: Correct.

Becker: And also a course of action we feel is necessary to file new applications to amend these, make these corrections, or if there's something we feel we can do in an amendment that would not introduce new matter.

Bernstein: And our strategy going forward on this. By the way, that would mean our strategy as well on the video, correct? Because if there needs to be changes and the date did stick at 8/10, we need to make any changes we find by 8/10, correct?

Becker: Only if the changes are so substantial that they would jeopardize the ability of one skilled in the art to understand.

Bernstein: Okay, so critical errors. Okay. If we find them.

Becker: And that's why I think, you know...and if you're describing in your specifications how to make one, how to do it, provide most of the details. I mean, we've done a very detailed job of ...

Bernstein: No, I agree. I'm not...I agree. I see all that here.

Becker: Any time whatever we can get out of you guys in terms of describing how it works...that, in there when you describe a claim and there's an error, you know, there's an error in the math, will that dramatically affect and make it so somebody can't practice the invention at all, I don't know.

Bernstein: Right. So if it's critical by 8/10, it should be resolved. Correct?

Becker: With the video application, it doesn't help for us to go back and look at those. You guys go back and look at those and see if there's anything in there that you don't like.

Bernstein: Right. And if we find something in the claim, for example, that we don't like, we need to amend it by 8/10, right?



Lorraine Christine Hoffman, Esq.
Assistant Staff Counsel
The Florida Bar
File No. 2003-51, 109(15C)

Becker: No.

Bernstein: Why?

Becker: Because the claims have to be supported by the specification as filed back on those dates, which were sometime in June...

Bernstein: Okay, but let's say all that fits, we also have the commercialization date.

Becker: The commercialization date...

Utley: I though <inaudible comment to Bernstein>

Bernstein: So we can go change the claims.

Becker: Typically [] prosecutions, as long as they're still supported by the specifications filed...

Bernstein: Right. So if we find any mistakes, we should change them, correct? In the video patents?

Becker: Yeah, as a general principle, that's a good idea.

Bernstein: Okay, good. All right. I think that sums up what we need. Send the letter to Si, myself, and Brian.

Becker: That's not a complete list of what you asked for me to do.

Bernstein: What else have we got? Sorry?

Becker: You've asked me to email to Jim Armstrong the three video applications and the playback application—the one playback application—

Bernstein: Right.

Becker: Now with respect to the video application, we have both PCT and US filings. Do you want us to send both of those? They've essentially identical—in fact, they are identical except the...



Lorraine Christine Hoffman, Esq.
Assistant Staff Counsel
The Florida Bar
File No. 2003-51, 109(15C)

Bernstein: No. Just one.

Utley: Send the US.

Becker: All right, we'll send the US versions of those two. And we'll fax the figures. And element #4...Item #4 is to provide a written letter to Jim Armstrong regarding the assignment status of...

Bernstein: Well, that's to everybody. That's to Brian, Si, myself, Jim.

Becker: Brian, Si, Eliot, and Jim.

Bernstein: Right. Just giving us the update of where we are.

Armstrong: I think it's helpful to communicate to the shareholders.

Bernstein: Well, let's get it first, then we'll communicate at discretion, but I think we're there.

Becker: Okay, then, in terms of general things going forward: Eliot needs to be cc:'d on all correspondence relating to patents. Should we continue our practice of sending things to Brian?

Bernstein: Yeah.

Becker: All right, we'll continue our practice of sending things to Brian and cc:ing Eliot with copies.

Bernstein: Right, and I'd appreciate if all that email comes to iviewit.com. Therefore, I have copied records.

Becker: Are you saying you only want us to correspond with you via email, not letters? Not...

Bernstein: No, but if it is emails, iviewit.com emails because that gives me complete copied records on tape backups.



Lorraine Christine Hoffman, Esq.
Assistant Staff Counsel
The Florida Bar
File No. 2003-51, 109(15C)

Armstrong: Do don't send anything to any of us at a domain name other than iviewit.com, if you send it in email.

Becker: That's the instructions?

Bernstein: Right.

Armstrong: Correct.

Becker: Don't send to any other email address besides one of your names at iviewit.com.

Bernstein: Correct.

Becker: Okay. Anything else in addition to those items?

Bernstein: Nope. Steve, I appreciate your taking the blunt end of this, I really do.

Becker: Well, I just wish you would not...

Bernstein: Well, we freak out a little bit. You can understand that there's a reason to freak...I'm not just making this up. So based on that, let's try to resolve and move forward.

Becker: Anything else?

Bernstein: Nope. Thanks very much.



Lorraine Christine Hoffman, Esq.
Assistant Staff Counsel
The Florida Bar
File No. 2003-51, 109(15C)

We submit further evidence that errors were made, corrected and then filed without the corrections and the letters that ensued over this. After these conversations where patent errors were found, we get a series of nasty letters from Douglas Boehm, attempting to minimize his errors. He gets fired immediately after from Foley and Lardner.



Lorraine Christine Hoffman, Esq.
Assistant Staff Counsel
The Florida Bar
File No. 2003-51, 109(15C)

Page 1 of 2

Eliot I. Bernstein

Subject: FW: Patent Application Issues
Importance: High

-----Original Message-----

From: James F. Armstrong
Sent: Wednesday, August 09, 2000 12:54 PM
To: Eliot I. Bernstein (E-mail); Brian G. Utley (E-mail); Douglas Boehm (E-mail); Simon L. Bernstein (E-mail); alps1@bellsouth.net
Subject: Patent Application Issues
Importance: High



Dear Doug,

The reason for the current air of discontent is a direct result of the conference call that occurred on Friday with Steve. Whether it was the content of the discussion or the tone of the discussion that is to blame for this discontent is not the issue. **The fact is that the call should have never taken place.** The impetus for the call was the identification of easily ascertainable mistakes in the math contained in the filing. Suffice it to say that if the math were correctly stated, there would not have been a conference call on Friday.

Now, why was the math incorrect? From my reading of your account of the whole process, the fundamental change in the expression of the aspect ratio necessitated a rewrite of the math at the 11th hour. This rewrite was handled by Brian and was not made available to me for review. If all that you did was copy and paste his "new" math into the filing, then the errors in the math can be attributed to 1.) Brian, for failure to diligently express all equations and examples consistently and accurately, and 2.) You, for what was an oversight of not checking the pasted information for the presence of squareroot symbols and references. The lateness of the hour did not afford you the luxury of rechecking Brian's math for accuracy and consistency; you had to assume that it was correct. However, it should be noted that nearly all of the errors contained in the filing were substantially the same errors/oversights that I identified and we all discussed during our initial conference call review of the 3rd draft.

In the end, the patent was filed in a form that was not ideal. Eliot's concern for the inaccuracies is valid especially in light of the fact that he cannot be expected to understand the importance or lack thereof of the errors in question. He has hired both you and Brian to be the shepherds of his intellectual property and he was fearful that these errors may have resulted in allowing a wolf to desimate his herd.

Your account of the whole process minimizes the importance of the errors that I found in the math and leaves me with the impression that iviewit would have been better off had I never been involved. Were that the case, then the errors in the math would have persisted since Brian's two revisions of the math still contained errors and inconsistencies. Eliot requested that I review the patents because he wanted a fresh set of eyes and a new perspective. That review revealed errors that would not have been identified when they were. In fact, during our conference call review of the 3rd draft you praised me for having caught an error and commented that it was "a good catch". Furthermore, a review of all of the changes that I made will reveal that there were no mistakes made by me in the corrections despite your assertion to the contrary. I feel that I've been made the scapegoat for Brian's errors and for your failure to fully discharge your obligation to ensure accuracy and completeness. I am neither the inventor of the process nor the author of the patents; I simply identified problems, provided accurate solutions to those problems and later found out that those solutions were not fully integrated.

4/24/2003



Lorraine Christine Hoffman, Esq.
Assistant Staff Counsel
The Florida Bar
File No. 2003-51, 109(15C)

Page 2 of 2

The writing of patents is a art form but they are also an exercise in precision. There was a lack of precision that took place which gave rise to Eliot's concern. Hopefully the absence of complete precision will not hurt us. In the end, I think that all of this could have been avoided had the patent process been managed better. Most importantly, the process should be managed to provide ample time for review, discussion and for changes. That management process should also anticipate contingencies and plan for them accordingly. As we all work towards the finalization of all iviewit patents, effective management of the process will ensure accuracy, completeness and our ultimate success.

As someone once said, "what doesn't kill us makes us stronger". I am hopeful that this experience will serve to strengthen all of our abilities individually and as a team.

Sincerely,

-Jim

James F. Armstrong
VP Sales & Marketing
iviewit.com, LLC.
Cell: 561-866-2042
Email: jim@iviewit.com

Northeast Offices
126 Buttonwood Drive
Fair Haven, NJ. 07704
Voice: 732-747-1448
Fax: 732-747-5569

Home Office
One Boca Place
2255 Glades Road
Suite 337 West
Boca Raton, FL. 33431
Voice: 877-484-8444
Fax: 561-999-8810

4/24/2003



Lorraine Christine Hoffman, Esq.
Assistant Staff Counsel
The Florida Bar
File No. 2003-51, 109(15C)

And further correspondence show Foley taking personal attacks at Eliot Bernstein over their faulty work product produced with Brian Utley.



Lorraine Christine Hoffman, Esq.
Assistant Staff Counsel
The Florida Bar
File No. 2003-51, 109(15C)

Page 1 of 7

Eliot I. Bernstein

From: Eliot I. Bernstein [alps1@bellsouth.net]
Sent: Wednesday, August 09, 2000 11:10 AM
To: Douglas Boehm (E-mail); James F Armstrong (E-mail); Simon L. Bernstein (E-mail); brian@iviewit.com



www.iviewit.com

Doug - As you can imagine I am a bit upset myself with last Friday's conversations but for different reasons. I have made not one single unfounded accusation. My remarks were based on facts. If you read the transcript what initiated that call was that when we received the patent that was filed, many of our changes were not incorporated. Most of the changes in the math that we spent the entire day with you laboring over were not incorporated in the patent. The math had fundamental errors still such as missing square roots etc. Also, if you listen to the tapes you will find that Brian was also upset that the math that he had sent several days earlier was also not included. Therefore, we seem to see wild accusations as separate items.

I would have liked to have more time to review the patent myself but you and Steve were working with Brian and I did not really have time to review until the week prior to filing when I first received the first draft. This gave me very little time to review prior to filing, so I am unclear as to how I could have done things any faster as you said in your letter. I figured we had established most of the meat of the invention when you came to our offices several months ago and that the final patent would have been well thought out, and that the math would be correct and tested. When I received the first draft of the filing, again, we had failed to cover zoom without pixelation. When I saw the complexity of the math, I asked my friend to explain it to me. What Jim found were huge errors that we spent our entire day reviewing with you. We agreed to those changes and we trusted that they would be incorporated in our filing. They were not. You now refer to these as minor changes but while we first reviewed them you called them very significant.

As you articulately pointed out, I am neither a patent attorney nor an engineer nor a mathematician, so I have hired people I do trust. What was shocking to me as naive as I may be was that these were items that were discussed to full understanding and yet they remained wrong. You cannot argue that there is much wrong with my anger since it remains founded in facts. Anger is associated with fear, and this seemed to put me and my partners in danger because of the errors. Thus, I re-acted to these facts by asking Steve what liabilities we would now encumber and this is of major concern to my shareholders etc. if there were liabilities that arose.

Regarding the patents Ray filed, it was you and Steve that pointed out that there could be problems in Ray's filings. Again, I re-acted in fear. How can the people we are entrusting to our inventions fail to serve us well? Thus, I alerted those involved and you presented your position on Ray Joao since you were the one who made the accusations in the first place. After listening to you we had decided to go back and amend Rays application to claim priority of all matter to that initial date. When we talked with Steve it was unclear if we were still on that same path and that

4/24/2003



Lorraine Christine Hoffman, Esq.
Assistant Staff Counsel
The Florida Bar
File No. 2003-51, 109(15C)

Page 2 of 7

was because of the bar date. We revisited the bar date issue and it became unclear as to whether it was September or August based on Centrack. When we noticed that the math and illustrations were not based on the stuff Brian had sent you we asked Steve to explain, he had no answer as to why it had been filed without it. Then, if you listen to the tapes, you will see that Brian was very upset that these changes had not been entered. He was shocked and so expresses his emotions on the tape. Have you written him an angry letter, calling him a wildcard that has unfounded accusations.

As to holding the meeting without you, we were very concerned about the mistakes in the filing and we did try several times to call you. Per Steve and your secretary it was determined that you were totally unreachable by any communication methods. We did not know that this was a foul and had Steve felt uncomfortable he should have passed on the call or brought Bill Dick in.

I have not gone behind your back and made accusations, I am simply trying to understand why the filing was missing the corrections we had worked on, and why Brian's math he had sent days earlier was not included and what this would expose us to. If the math mistakes were critical, it would have been I who would have had to explain to our board why their investments may have not been adequately protected. How would you feel in that position?

Since these items that will be corrected are in fact mistakes and not accusations of mistakes, I fail to understand why your retort appears so hostile. Why you feel the need to attack my personality etc. The point of Friday's conversation was to make changes where change is due and move forward, together. We asked for a clear and concise letter addressing these and other issues that would help clear up the mistakes etc.

I do understand why you want to seek wrath against me or my company for founded factual mistakes, made on your part. I was expecting an apology from you as to why this occurred in the first place, not a letter accusing me of any wrong doings. I did nothing wrong. I feel that the bill for that filing should instead be reduced for the time and effort that was wasted and will be further wasted fixing the errors.

I am a little confused by the statement; "Since you seem to have a predisposition to sue your patent lawyers, I now have to religiously follow all of our firms practices and procedures for documenting everything I say and do with you." Why were we not doing this all along, as it seems a practice of the firm to protect your clients and why would this subject me to additional rates?

I am also puzzled as to why you chose to write me directly and not include the other people involved in this matter. First, Brian was also very upset and puzzled by this. Brian, unlike me, has good knowledge in this arena; he has been hired to handle the intellectual property of the firm. If anyone has failed to understand any of the things you have mentioned, you must confront him. Brian has been working with you to develop and cultivate the property; if we are in the dark you must confront him. I am naive in this world and this is why I have entrusted both him and you to protect the company. Also, my father was on the phone and Jim Armstrong and neither have felt that I did anything wrong or unjust. Thus, I feel obligated to let them respond to your letter as well.

I am sorry for your feeling that I have accused you of wrong doings. I was just upset with the facts of the matter and may have seemed scared and afraid. I like both Steve and yourself and do appreciate all you have done. It does not negate the problems though. I am unsure of how you



Lorraine Christine Hoffman, Esq.
Assistant Staff Counsel
The Florida Bar
File No. 2003-51, 109(15C)

Page 3 of 7

want to proceed with the firm but I think this need to be handled by all involved parties.

Best regards,

Eliot

-----Original Message-----

From: Boehm, Douglas A.
To: Eliot Bernstein (Iviewit)
Sent: 8/9/00 2:46 AM
Subject: PERSONAL AND CONFIDENTIAL

PERSONAL AND CONFIDENTIAL
ATTORNEY-CLIENT PRIVILEGED

Eliot--

I need to discuss something personally with you that is very important to our working relationship. I am sending this via e-mail and only to you, without copying Brian or anybody else, so whether you share it or not is entirely up to you. Please take the time to read and consider the following.

I am very upset with the way you handled the situation at last Friday's teleconference with Steve Becker regarding the latest patent application filing, and I am particularly offended by your exaggerations, accusations, and criticisms of our work. I listened to the tape of the teleconference, and I was shocked.

First, you know that I am the Foley & Lardner partner responsible for Iviewit work, and Steve Becker is the associate who reports to me. I can't believe that you decided to hold that teleconference Friday with Steve without me being present. That was really low. If you want to fly off the handle and jump to conclusions without talking to Brian first, that's your business. But when it comes to making accusations about the quality of my work product to my associate, that's my business.

Second, Steve and I have consistently put 110% effort into everything we have done for you. Last week, I put in 200% effort, flying down to Florida on short notice so you can hold a meeting to figure out if you were going to sue your former patent attorney, having me spending all the next day with your investment bankers, and then spending the night in the O'Hare airport and coming directly to work the very next day to revise and file a patent application for you by midnight. I don't know very many people that would have done that for a client. Now you get all bent out of shape over a few minor math mistakes -- which are readily correctable.

4/24/2003



Lorraine Christine Hoffman, Esq.
Assistant Staff Counsel
The Florida Bar
File No. 2003-51, 109(15C)

Page 4 of 7

Third, during the Friday teleconference, you accused us of changed strategies, filing delays, and huge mistakes. If there were any strategy changes, they were partly your fault -- because you don't understand what's happening on the IP side of your business, even though we have tried to explain it all to you many times. But that's fine if you trust your people. You have excellent people working with you, but you simply don't listen to us. Instead, you make wild accusations and inflammatory statements about things you know nothing about. The delays and the mistakes were also, to a large extent, your fault. Had you gotten Jim involved earlier, had you worked closer with Brian to understand the math, had you spent more time reviewing the application drafts, then perhaps none of this would have happened. You can't just sit back now and blame us. Sorry, but I won't put up with it.

Fourth, you have strained our working relationship. We now have to tape each others' telephone conversations so we can point fingers and threaten to sue each other? What kind of a working relationship is that? I figured out from day one that you were a wildcard, but I didn't mind that, because I can relate to wildcards. A lot of brilliant inventors are wildcards. I have even been accused of being a wildcard myself. But just because you're a wildcard doesn't mean you have the right to make unfounded accusations and cut people off at the knees.

I'm afraid this latest episode is going to cost you. Steve Becker won't work on any Iviewit matters any longer for me. That's going to cost you an additional \$40.00 per hour in legal fees, now that I have to do the work myself. Since you seem to have a predisposition to sue your patent lawyers, I now have to religiously follow all of our firms practices and procedures for documenting everything I say and do with you. That's going to take me extra time and cost you extra money. Foley & Lardner raises its billing rates on September 1st, and I was previously considering discounting our rates for Iviewit as I have done in the past. After all of your accusations, I don't have any inclination to do so. I've also been dragging my feet on providing you with our bills, as a favor to you and Brian, since I knew you were cash-strapped. No more. I'm sending your bills as soon as I can. I have somehow lost my motivation to get into hot water with my firm for such an unappreciative client.

The way I see it, you owe us an apology. Steve worked many long, frustrating hours trying to pull an invention out of your head and get it down on paper. Apparently Ray Joao had the same problem. You owe Steve an apology for blaming him, without proof, of cutting and pasting the mathematical formulas into the wrong document, and for accusing him of not copying you on the patent correspondence, and for getting angry and using profanity at the meeting. No lawyer should have to put up with that kind of abuse from a client -- let alone a bright young associate like Steve. Fortunately for him, Foley & Lardner has enough work that he doesn't need to work for me on Iviewit patent applications for billable hours -- so he's not going to anymore.

4/24/2003



Lorraine Christine Hoffman, Esq.
Assistant Staff Counsel
The Florida Bar
File No. 2003-51, 109(15C)

Page 5 of 7

I think you owe me an apology too, and I consider myself pretty thick-skinned when it comes to these kinds of things. I have spent numerous nights and weekends working on your agreements and patent applications in order to satisfy your unreasonably short deadlines. Then you accused me in front of everybody -- but behind my back -- of changing the math without your knowledge, altering numbers, missing a priority date, not filing the changes everybody agreed to, missing diagrams from final patent documents, changing filing strategies, and generally providing you with inferior work product. As you can see from my letter explaining the so-called errors, you blew everything out of proportion, and without even talking to Brian or me. You got everybody all excited, including your Father, and you're also talking about notifying the stockholders. Notifying them of what? Your unfounded accusations?

In order for me to continue working with you, you need to change. You need to promise me that you will act in a civil and professional manner from here on out. If you don't like the way I'm doing something, call me on it -- don't hold a meeting about it without me. If you don't understand a particular patent strategy, just ask me --instead of accusing me of changing the strategy. If a problem occurs on a team of which you're a member, try to resolve it as a team effort -- don't distance yourself and blame it on somebody else when you are partly at fault.

You first had problems with Ray Joao, so you came to Foley & Lardner. Now you have problems with us, and Steve bailed out. Are you still going to have problems with me and my work product? Well, you can either work with me to resolve your problems in a civil and professional manner, or you can find another patent law firm that will put up with your unreasonable manner and abuse.

Eliot, by spending time on holding meetings to blame your lawyers, you are missing the bigger issues with your technology. Corrections to the math of that last patent application are relatively meaningless. You've got much bigger things you should be worrying about. We have told you about them before, but I'm not sure you're listening.

First, you don't seem to have a good feel whether or not your technology is patentable. You don't personally have the background to tell whether your technology is new. You don't appreciate that this technology is in a very crowded and fast-paced field, and will be difficult to obtain broad patent coverage. You have not performed any technical searches to determine what the state of the art was at the time of your invention. You don't know how to help us describe your invention or distinguish it from the prior art that we do know about. You just seem to be assuming that everything you did is patentable or can be made so. And if not? Oh, that's easy. Then blame the lawyers.

Second, you essentially argued to Wachovia that it doesn't matter if your competitors are currently using the same or similar technology as

4/24/2003



Lorraine Christine Hoffman, Esq.
Assistant Staff Counsel
The Florida Bar
File No. 2003-51, 109(15C)

Page 6 of 7

Iviewit, because you were the first one to do it. Don't you realize that this argument doesn't fly if you don't have granted patents? When our PCT applications publish within the next six months, most if not all of your trade secrets will be lost. So then you want to go license the technology and know-how? And Iviewit is a newcomer in the industry? This could be tough. Even if the patents do issue, but a competitor refuses to accept your technology license, do you have a spare million dollars or two to sue them for patent infringement? Have you thought about any of this?

Third, I doubt if you have never checked to see if your competitors have patents covering your technology. You may find out, rather abruptly I'm afraid, that the people you're going to attempt to license may have a better patent portfolio than you do. All of a sudden you'll end up being the licensee. Or what's worse, you may have to shut down and re-engineer your business to avoid a multimillion dollar patent infringement lawsuit. This is a real risk -- much more of a risk than losing a priority date because a square root sign was missing from a math formula of an example in one of your patent applications. You should keep things in perspective.

During the Friday teleconference, you say that you don't know why we came up with a potential bar date of September 1, 2000, yet when Brian tried to explain it to you, you refused to listen. Now you independently decide that everything must be done by August 10th. That cannot realistically be accomplished. Furthermore, I don't think it is necessary. Based on our understanding when we were there in May, and based on Brian's comments on Friday, it does not appear that 8/10/99 started the one-year clock. According to both you and Brian, there was no public disclosure of the invention on that date, and there was no offer for sale of the invention. If you know of contrary facts, please provide them. But I refuse to jump through hoops that you arbitrarily set up just because you don't understand the law, or just because you get a kick out of seeing lawyers jump through hoops.

I realize that it is not commonplace for outside counsel to be so blunt and upset with a client, so I apologize for sending this e-mail. However, I felt that you needed to be told these things now, and in a straightforward manner, and in writing, in order to salvage our relationship. We cannot go on working like this. If you don't like the quality of our services or work product, then please fire us and go find yourself another group of lawyers who will put up with you. Otherwise, if you value our working relationship, you'll simply have to change the way you deal with people.

Please let me know what you decide.

--Doug

>Douglas A. Boehm

4/24/2003



Lorraine Christine Hoffman, Esq.
Assistant Staff Counsel
The Florida Bar
File No. 2003-51, 109(15C)

Page 7 of 7

>Foley & Lardner
>777 East Wisconsin Avenue
>Milwaukee, Wisconsin 53202
>Tel: (414)297-5718
>Fax: (414)297-4900
>Email: daboehm@foleylaw.com

>
>NOTE: The information transmitted in and/or attached to this message
>is intended only for the person or entity to which it is addressed and
>may contain confidential and/or privileged material. Any review,
>retransmission, dissemination, or other use of, or taking any action in
>reliance upon, this information by persons or entities other than the
>intended recipient is prohibited. If you received this information in
>error, please contact the sender and delete the material from any
>computer.

>
>Best regards,

Eliot
Eliot I. Bernstein
Founder & Chief Technology Officer

iviewit.com
email: eliot@iviewit.com
palm mail: eliotb@palm.net
Web: www.iviewit.com
2255 Glades Road
Suite 337 West
Boca Raton, FL 33431
Voice: 561.999.8899
Fax: 561.999.8810
Toll Free: 877.484.8444
Cellular: 561.212.9254

4/24/2003

iin

Confidential

Page 516 of 722

4/30/2003



Lorraine Christine Hoffman, Esq.
Assistant Staff Counsel
The Florida Bar
File No. 2003-51, 109(15C)

Then after Mr. Armstrong had corrected the math errors of Mr. Utley and Foley and Lardner he gets fired. We submit the following evidence:



Lorraine Christine Hoffman, Esq.
Assistant Staff Counsel
The Florida Bar
File No. 2003-51, 109(15C)

Page 1 of 1

Eliot I Bernstein

Subject: FW: more of the same
Importance: High

-----Original Message-----

From: Jim Armstrong [mailto:jarmstrong1@home.com]
Sent: Friday, April 20, 2001 8:48 AM
To: eliot@iviewit.com
Subject: congratulations
Importance: High

Eliot,

Maybe now that Brian is gone, iviewit can have a chance at success. This guy set us back at least a year. He bumbled the patent process; if you need it, I have all my notes showing how he screwed up the patent applications and cost us time and perhaps ultimately a fortune. It wouldn't surprise me to find out that he intended to file the patents improperly and that he is conspiring with others to claim iviewit's inventions for himself. Brian is a classless individual with no business sense whatsoever. He never communicates with his employees - NEVER - no returned phone calls and never an email. What a dinosaur.

He and Ray have ignored my recent request for payment of my note. Prior requests for payment have elicited a response from Ray that it was "not a convenient time" to pay the note off. Ray and Brian fail to understand that, convenient or not, this is an obligation of the company. Convenience has nothing to do with it. Proskauer was mailed a letter from my attorney on 3/28/01 demanding payment; no response has been received. A scan of the letter is attached to this email.

I helped found the company. I provided cash to the company when requested. I worked for the company at the company's request. Brian fired me because I was a threat to him; because I knew he screwed up the patents and because I created a comprehensive financial model after he failed at that task. Brian and Ray have screwed me out of my commissions.

Now they are gone and real business people are running the company; men with pride and ethics and decency - please cut me a check for \$24,880.30. No more excuses please. Today's board meeting would be an excellent time to get this payment approved and paid.

Sincerely,

-Jim

Jim Armstrong

4/27/2003



Lorraine Christine Hoffman, Esq.
Assistant Staff Counsel
The Florida Bar
File No. 2003-51, 109(15C)

In another instance of patent malfeasances Utley with the help of Foley and Lardner then tries to add himself as inventor to the patent office on this filing for an idea that was created prior to his joining Iviewit.



Lorraine Christine Hoffman, Esq.
 Assistant Staff Counsel
 The Florida Bar
 File No. 2003-51, 109(15C)

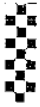

RECEIVED 04/27/2001 3:30 PM 3RD FLOOR

NO. 296 P. 1/5

FOLEY & LARDNER
 ATTORNEYS AT LAW
 FIRSTAR CENTER
 777 EAST WISCONSIN AVENUE
 MILWAUKEE, WISCONSIN 53202-5367
 TELEPHONE (414) 271-2400
 FACSIMILE (414) 297-4500

FACSIMILE TRANSMISSION

Total # of Pages 5 (including this page)

TO:	PHONE:	FAX #:
Brian Utley Raymond Hersh - <i>Why is RAY here</i> Ross Miller Iviewit.com, Inc.	561-999-8899	561-999-8810

From: Barry L. Grossman
 Sender's Direct Dial: 414 297 5724
 Date: April 27, 2001
 Client/Matter No: 057103/0118
 User ID No: 2030

MESSAGE:

If there are any problems with this transmission or if you have not received all of the pages, please call (414) 297-5444.

Operator: _____ Time Sent: _____ Return Original To: Barry L. Grossman

CONFIDENTIALITY NOTICE: THE INFORMATION CONTAINED IN THIS FACSIMILE MESSAGE IS INTENDED ONLY FOR THE PERSONAL AND CONFIDENTIAL USE OF THE DESIGNATED RECIPIENTS NAMED ABOVE. THIS MESSAGE MAY BE AN ATTORNEY-CLIENT COMMUNICATION, AND AS SUCH IS PRIVILEGED AND CONFIDENTIAL. IF THE READER OF THIS MESSAGE IS NOT THE INTENDED RECIPIENT OR ANY AGENT RESPONSIBLE FOR DELIVERING IT TO THE INTENDED RECIPIENT, YOU ARE HEREBY NOTIFIED THAT YOU HAVE RECEIVED THIS DOCUMENT IN ERROR, AND THAT ANY REVIEW, DISSEMINATION, DISTRIBUTION OR COPYING OF THIS MESSAGE IS STRICTLY PROHIBITED. IF YOU HAVE RECEIVED THIS COMMUNICATION IN ERROR, PLEASE NOTIFY US IMMEDIATELY BY TELEPHONE AND RETURN THE ORIGINAL MESSAGE TO US BY MAIL. THANK YOU.

001.002383.1

Cover Page 1 of 1



Lorraine Christine Hoffman, Esq.
 Assistant Staff Counsel
 The Florida Bar
 File No. 2003-51, 109(15C)

MAIN WORKSHEET 3RD FLOOR

NO. 994 P. 1/31

FOLEY & LARDNER
 ATTORNEYS AT LAW
 FIRST STAR CENTER
 777 EAST WISCONSIN AVENUE
 MILWAUKEE, WISCONSIN 53202-5357
 TELEPHONE (414) 297-1200
 FACSIMILE (414) 297-4900

6

FACSIMILE TRANSMISSION

Total # of Pages 31 (including this page)

TO:	PHONE:	FAX #:
Brian Utley (Guest - Room 1205)	(407) 828-2828	(407) 827-3977

From: Steve Becker
 Sender's Direct Dial: (414) 297-5571
 Date: June 7, 2000
 Client/Matter No: 057103/0101 (0118)
 User ID No: 1963

MESSAGE:

PRIVILEGED AND CONFIDENTIAL

URGENT - PLEASE DELIVER IMMEDIATELY

If there are any problems with this transmission or if you have not received all of the pages, please call (414) 297-5444.

Operator:	Time Sent:	Return Original To:
		SCB
<small>CONFIDENTIALITY NOTICE: THE INFORMATION CONTAINED IN THIS FACSIMILE MESSAGE IS INTENDED ONLY FOR THE PERSONAL AND CONFIDENTIAL USE OF THE DESIGNATED RECIPIENTS NAMED ABOVE. THIS MESSAGE MAY BE AN ATTORNEY-CLIENT COMMUNICATION, AND AS SUCH IS PRIVILEGED AND CONFIDENTIAL. IF THE READER OF THIS MESSAGE IS NOT THE INTENDED RECIPIENT OR ANY AGENT RESPONSIBLE FOR DELIVERING IT TO THE INTENDED RECIPIENT, YOU ARE HEREBY NOTIFIED THAT YOU HAVE RECEIVED THIS DOCUMENT IN ERROR, AND THAT ANY REVIEW, DISSEMINATION, DISTRIBUTION OR COPYING OF THIS MESSAGE IS STRICTLY PROHIBITED. IF YOU HAVE RECEIVED THIS COMMUNICATION IN ERROR, PLEASE NOTIFY US IMMEDIATELY BY TELEPHONE AND RETURN THE ORIGINAL MESSAGE TO US BY MAIL. THANK YOU.</small>		

001.735431.1

Cover Page 1 of 1



Lorraine Christine Hoffman, Esq.
 Assistant Staff Counsel
 The Florida Bar
 File No. 2003-51, 109(15C)

JUN 7 2000 1:32PM 3RD FLOOR

NO. 934 P. 2/31

⑨

FOLEY & LARDNER

ATTORNEYS AT LAW

CHICAGO
 DENVER
 JACKSONVILLE
 LOS ANGELES
 MADISON
 MILWAUKEE
 ORLANDO

PIRETTA CENTER
 777 EAST WISCONSIN AVENUE
 MILWAUKEE, WISCONSIN 53202-8367
 TELEPHONE (414) 271-2400
 FACSIMILE (414) 271-4900

SACRAMENTO
 SAN DIEGO
 SAN FRANCISCO
 TALLAHASSEE
 TAMPA
 WASHINGTON, D.C.
 WEST PALM BEACH

EMAIL ADDRESS
 sbecker@foleylaw.com

Via Facsimile

WRITER'S DIRECT LINE
 (414) 297-5571

June 6, 2000

CONFIDENTIAL AND PRIVILEGED

Mr. Brian G. Utley
 President
 Iviewit.com, Inc.
 One Boca Place
 2255 Glades Road, Suite 357 West
 Boca Raton, Florida 33431

Re: PCT International Patent Application
 Title: System and Method for Video Playback Over a Network
 Inventor(s): Bernstein et al.
 Our Ref.: 57103/117

Dear Brian:

Enclosed please find the first draft of the above-referenced patent application (last page marked 001.793381.1), which has been prepared in accordance with the previously filed U.S. provisional patent applications (MLG Docket Nos. 5865-4 and 5865-4.1). As you know, a careful and critical review of this draft application by you and the inventors is imperative to ensure that the you are all satisfied with the content of the application and the proposed claim scope.

I note that Jeff Friedstein is named as a co-inventor on this application pursuant to Elliot Bernstein's instructions. Accordingly, Jeff must review a draft of the application before filing.

I also note that the deadline for filing this application in order to claim priority to all related provisional applications is Wednesday, June 7, 2000. Therefore, we must receive your comments as soon as possible.

Please have the inventor(s) thoroughly read the application draft, including the specification, claims, and drawings, to ensure that it provides a complete and accurate description of the invention. The attached "Inventor Information Sheet" provides a brief explanation of the parts of a utility patent application, the duty of disclosure, and inventorship. I would also like you to personally read and comment on this draft.

ESTABLISHED 184

A MEMBER OF GIBSON, CRUTCHER & DANIELSON, P.C. OFFICES IN BOSTON, BRUSSELS, GENEVA, FRANKFURT, LONDON, SINGAPORE, STOCKHOLM AND STUTTGART



Lorraine Christine Hoffman, Esq.
Assistant Staff Counsel
The Florida Bar
File No. 2003-51, 109(15C)

FOLEY & LARDNER

Mr. Brian G. Utley
June 6, 2000
Page 2

This PCT application incorporates all of the subject matter of U.S. Provisional Patent Application No. 60/137,921, filed June 7, 1999 (MLG Docket No. 5865-4) and U.S. Provisional Patent Application No. 60/141,440, filed June 29, 1999 (MLG Docket No. 5865-4.1).

You and the inventors should feel free to supplement, correct, or modify any part of the application. In particular, please review the subject matter disclosed in the two above-referenced provisional patent applications. After your review, if you or the inventors feel that any subject matter from these three provisional patent applications should be reflected in the draft PCT application, but is not, please notify me immediately.

The drawings attached to the application are informal sketches that will suffice for purposes of filing. Formal drawings will be prepared at a later date, as they are required for publication of the PCT application.

During the review, please keep in mind that independent claims 1, 12, 19, 24, 31, and 38 are the broadest statements of the invention, and the remaining dependent claims add limitations to further define different embodiments of the invention. Please note that it is the inventor's legal obligations to "read and understand" the contents of the application - including the claims. Each inventor will have to sign a declaration attesting that they did so.

Please have the inventors mark the appropriate changes on this copy of the application, make a copy of the changes, and return the hand-corrected copy to me via facsimile. A revised application incorporating the changes will then be submitted to you for your approval. We will handle execution of the formal papers at a later date.

Pursuant to your instructions, to preserve foreign filing options, I plan to designate all of the countries for filing under the PCT (see attached list of PCT Contracting States). Note, however, that not all foreign countries are members of the PCT (e.g., Taiwan), so to maintain the benefit of priority to the U.S. applications, we would have to file foreign national applications immediately in those non-PCT countries. This would require up-front translation costs and sufficient time for our foreign associates to prepare and file the applications before June 7, 2000. It is my understanding that you DO NOT want us to file in any countries other than those that are members of the PCT. Please let me know IMMEDIATELY if this understanding is not correct.

001.795108.1



Lorraine Christine Hoffman, Esq.
Assistant Staff Counsel
The Florida Bar
File No. 2003-51, 109(15C)

JUN 7 2000 1:35PM 3RD FLOOR

NO. 934 P. 4/31

FOLEY & LARDNER

Mr. Brian G. Utley
June 6, 2000
Page 3

If you or the inventors have any questions, please do not hesitate to contact me.
I look forward to receiving at least your preliminary comments on the application by
tomorrow.

Very truly yours,

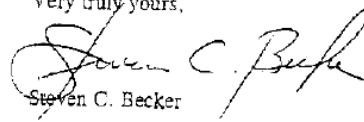

Steven C. Becker

Enclosure(s)
cc: Douglas A. Boehm

001.725106.1



Lorraine Christine Hoffman, Esq.
Assistant Staff Counsel
The Florida Bar
File No. 2003-51, 109(15C)

JUN 7 2003 1:35PM 3RD FLOOR

NO. 934 P. 9/31

57103/118

PCT INTERNATIONAL PATENT APPLICATION
for
SYSTEM AND METHOD FOR VIDEO PLAYBACK
OVER A NETWORK

Inventors: Eliot J. Bernstein
500 S.E. Mizner Boulevard
Boca Raton, FL 33432-6080
Citizenship: U.S.



Jeffrey S. Friedstein
2142 Churchill Lane
Highland Park, IL 60035
Citizenship: U.S.



FOLEY & LARDNER
Attorneys at Law
777 E. Wisconsin Avenue
Milwaukee, Wisconsin 53202
(414) 271-2400



Lorraine Christine Hoffman, Esq.
 Assistant Staff Counsel
 The Florida Bar
 File No. 2003-51, 109(15C)

2/4

PCT REQUEST

Original (for SUBMISSION) - printed on 07.06.2000 07:16:34 PM

57103/118

III-2	Applicant and/or inventor	
III-2-1	This person is:	applicant and inventor
III-2-2	Applicant for	US only
III-2-4	Name (LAST, First)	FRIEDSTEIN, Jeffrey, S.
III-2-5	Address:	2142 Churchill Lane Highland Park, IL 60035 United States of America
III-2-6	State of nationality	US
III-2-7	State of residence	US
III-3	Applicant and/or inventor	
III-3-1	This person is:	applicant and inventor
III-3-2	Applicant for	US only
III-3-4	Name (LAST, First)	UTLEY, Brian, G.
III-3-5	Address:	1930 SW 8th Street Boca Raton, FL 33486 United States of America
III-3-6	State of nationality	US
III-3-7	State of residence	US
IV-1	Agent or common representative; or address for correspondence	
	The person identified below is hereby/has been appointed to act on behalf of the applicant(s) before the competent International Authorities as:	agent
IV-1-1	Name	FOLEY & LARDNER
IV-1-2	Address:	777 East Wisconsin Avenue 33rd Floor Milwaukee, WI 53202-5367 United States of America
IV-1-3	Telephone No.	414 271-2400
IV-1-4	Facsimile No.	414 297-4900
IV-1-5	e-mail	sbecker@foleylaw.com
V	Designation of States	
V-1	Regional Patent (other kinds of protection or treatment, if any, are specified between parentheses after the designation(s) concerned)	AP: GH GM KE LS MW MZ SD SL SZ TZ UG ZW and any other State which is a Contracting State of the Harare Protocol and of the PCT EA: AM AZ BY KG KZ MD RU TJ TM and any other State which is a Contracting State of the Eurasian Patent Convention and of the PCT EP: AT BE CH&LI CY DE DK ES FI FR GB GR IE IT LU MC NL PT SE and any other State which is a Contracting State of the European Patent Convention and of the PCT OA: BF BJ CF CG CI CM GA GN GW ML MR NE SN TD TG and any other State which is a member State of OAPI and a Contracting State of the PCT



Lorraine Christine Hoffman, Esq.
Assistant Staff Counsel
The Florida Bar
File No. 2003-51, 109(15C)

Finally, after Mr. Utley and Foley and Lardner came under suspicion for these filings, the Company began to hire other counsel and Irell and Manella was brought in as California counsel to draft licensing agreements for Warner Bros. and Sony. As they began a review of the patents they brought in Blakely Sokoloff Zafman and Taylor as patent experts to review the work of both Foley and Lardner and Raymond Joao. Problems were evident in the provisional filings by Joao who had missed much of the inventions in the filings, and further problems were carried forward by Foley and Lardner as they appeared to have continued Raymond's mistakes and caused a whole set of new ones.

The inventions by Foley & Lardner continued to misrepresent the true inventors and in fact had added Mr. Utley to replace inventors or add him to inventions he had not created. Further, they had left out key issues that left the Company open to exposure and which Blakely Sokoloff Zafman and Taylor had to file further amendments too. Finally, they found that patents had been secretly been written with Brian Utley as the sole inventor of core technologies, that these patents had been sent to his home address and they had no assignment to Iviewit or it's investors. Most bizarre, these filings had been completed by Iviewit's patent counsel Foley and Lardner, led by Mr. William Dick. The Company because of the hidden truth by Mr. Wheeler that Mr. Dick and Mr. Utley had prior misappropriated patents from Mr. Monte Friedkin and his Companies was in complete shock. The investors, Crossbow, who were funding the BSTZ investigation into the patents became very concerned and paid for the amendments to the patents and then without notice stopped funding the Company and has recently tried to assign their loans and secured interest to another Company.

We submit again and in conclusion the following patent which is one of two that BSTZ found that illustrate this patent theft.



Lorraine Christine Hoffman, Esq.
Assistant Staff Counsel
The Florida Bar
File No. 2003-51, 109(15C)

Atty. Dis. No. 57103/123

U.S. PROVISIONAL PATENT APPLICATION

for

**ZOOM AND PAN IMAGING
DESIGN TOOL**

Inventors:



Brian G. Utley
1930 SW 8th Street
Boca Raton, FLORIDA 33486
Citizenship: U.S.

FOLEY & LARDNER
Attorneys at Law
777 E. Wisconsin Avenue
Milwaukee, Wisconsin 53202
(414) 271-2400



Lorraine Christine Hoffman, Esq.
Assistant Staff Counsel
The Florida Bar
File No. 2003-51, 109(15C)

Mr. Wheeler had another Conflict of Interest in drafting a letter agreement with a Real 3D subcontractor a Mr. Ryan Huiseman of a Company RYJO. Mr. Wheeler drafted an agreement with Mr. Utley that in effect allowed a Real3D subcontractor under an NDA drafted by Mr. Wheeler, to design an image applet that Mr. Huiseman and another Real3D ex-employee Garrett Clark went and trademarked and copyrighted. What happened was that as Mr. Huiseman learned of our techniques he and Mr. Clark (who had no NDA with the Company and was unauthorized to even see the processes) drafted the algorithm for the zoom technology and certain video technologies into an applet that was created for Iviewit, and went and procured protection for it. What is noticeable throughout the many months of billing entries for this transaction, is that Mr. Wheeler tries to couch his work as a "website agreement", when it is in fact an attempt to abscond with the core algorithms and mathematics of the Iviewit Zoom process and in fact in some instances it appears in the bill as an Apple. This work should have been performed if it had been approved by a patent attorney with licensing background.

We cite from the billings:

Mr. Utley and Mr. Michael Reale (another Wheeler referral from Boca Research Company) came to Eliot Bernstein and told him to sign the agreement that Wheeler had drafted for the Phokus Image Applet. Mr. Bernstein reviewed such agreement and found that it stated that Iviewit would be licensing the technology from RYJO and would receive partial payment and partial ownership in the applet. Mr. Bernstein demanded an explanation as to how the Company was licensing it's own technology from a subcontractor. Mr. Utley and Mr. Reale explained to Mr. Bernstein that the applet was not the Companies because the Company had failed to secure an NDA on RYJO or Ryan so he in fact had owned it and was doing us a favor in giving us an interest back. Mr. Bernstein called Mr. Wheeler to explain and he came over and opined that indeed it looked like RYJO owned it but it was a fair deal in light of the lack of an NDA that he had drafted. Mr. Bernstein demanded that Timothy Connelly of Real3D be contacted to explain why his subcontractor was not under NDA and he confirmed quite the opposite, that R3D had in fact signed an NDA with RYJO and the Company was covered.

We submit as evidence RYJO NDA as secured by Real3D and Mr. Wheeler:



Lorraine Christine Hoffman, Esq.
Assistant Staff Counsel
The Florida Bar
File No. 2003-51, 109(15C)

Page 1 of 1

Eliot I. Bernstein

Subject: FW: Confidentiality Agreement

-----Original Message-----

From: Eliot I. Bernstein [mailto:res0bf4a@verizon.net]
Sent: Monday, August 06, 2001 2:45 PM
To: Eliot Bernstein
Subject: FW: Confidentiality Agreement

-----Original Message-----

From: Tim Connolly [mailto:connolly@real3d.com]
Sent: Tuesday, September 07, 1999 6:41 AM
To: Brian G. Utley; Eliot I. Bernstein (E-mail); Wheeler, Christopher
Cc: Richard Gentner
Subject: Confidentiality Agreement

Good Morning Brian,

Received your call this AM. We had Ryan sign a Non-Disclosure Agreement prior to briefing him on any of the details regarding I-View-It. That is standard policy at Real 3D.

Call if you have any other questions regarding this matter. I assumed that the teleconference never materialized last Friday.

Regards,

Tim Connolly

Incoming mail is certified Virus Free.
Checked by AVG anti-virus system (<http://www.grisoft.com>).
Version: 6.0.391 / Virus Database: 222 - Release Date: 9/19/2002

4/20/2003

We submit as evidence the following:



Lorraine Christine Hoffman, Esq.
Assistant Staff Counsel
The Florida Bar
File No. 2003-51, 109(15C)

The Phokus Image Applet as Trademarked and Copyrighted by RYJO.



Lorraine Christine Hoffman, Esq.
Assistant Staff Counsel
The Florida Bar
File No. 2003-51, 109(15C)

Phokus™

Project Outline prepared 12/8/99

1. Overview

1.1 Summary

Phokus™ is a Java applet for specialized viewing of 360° surround-images within an Internet web page. It features a customizable interface that allows for logo placements, advertising displays, navigation controls, status bars, and online help. Users may use a mouse or keyboard to smoothly pan and zoom through the virtual environment.

When a user opens a web page that contains the Phokus™ applet for the first time it may take a few extra seconds for the Java code to be downloaded; after that it will be able to start very quickly. As the applet starts the first thing visible will be a logo image, followed by one or more advertisement images which can be displayed for variable lengths of time. While the ad(s) is showing an optional progress bar will also be displayed indicating the status of the downloading main image. When the download is complete the ads will be replaced by the surround-image and the navigation controls will become visible and active.

The navigation controls allow the user to pan left, right, up, and down as well as zoom in or out. Motion is smooth and responsive to enable easy viewing of an image.

2. User's Guide

2.1 Requirements

Phokus™ is a Java applet meant to be displayed within the framework of a web browser, and as such requires the browser to have Java support enabled. It will work equally well with recent (4.0 or higher) Netscape or Microsoft Internet browsers.

2.2 Operational Stages

As the Phokus™ applet is loaded and initialized there is a timeline of events that controls what is being displayed at any given moment and how users can interact at that time.

Stage 1. The first thing the applet does is to display a text string (supplied by a Parameter) in the center of the drawing area. The initial logo begins downloading.

Stage 2. When the initial logo has completed downloading it is displayed in place of the text string. The progress bar is now displayed. The first ad begins downloading. The main image begins downloading. The advertising image delay/duration clock is started.

Stage 3. All advertising images are displayed (concurrently or sequentially) according to their delay/duration settings. Progress bar is updated.

it.



Lorraine Christine Hoffman, Esq.
Assistant Staff Counsel
The Florida Bar
File No. 2003-51, 109(15C)

Stage 4. Main image is displayed in place of ads. Progress bar is gone. Embossed logo is displayed. Navigation icons are displayed. User interactivity is now enabled.

2.3 Display Elements

The applet and its user interface are made up of several discrete elements which are described below:

InitialLogo. This is the first image that appears. It should be very small and fast loading (<3K). It only lasts until the first ad has downloaded.

ProgressBar. This control bar stretches along the bottom horizontal border of the applet and displays the progress of the main image loading process. When it is complete, the bar will sink smoothly into the bottom of the screen and disappear.

Advertising. Advertising images will be centered on the applet display screen and can be any size. If the delay/duration schedule has more than one ad showing at any given time, then they will be spaced evenly on the screen.

MainImage. The main image begins loading at the same time as the first ad, but will not be displayed until the ad display cycle has completed. A significant amount of processing will occur just after the image is downloaded, but the user will never see the image until it is 100% ready for viewing.

EmbossedLogo. An embossed logo may be placed in the lower right corner of the screen. It should be a 16-level gray scale image, with white being highest.

NavigationIcons. On-screen navigation icons show the status of user interactions and can be clicked on as buttons themselves. They include: pan left, right, up, down, zoom in or out, and help.

HelpScreen. The main image can be temporarily replaced by a single help page with useful tips for getting around in Phokus.

2.4 Applet API

Control of the Phokus™ environment is through standard "parameter" tags, which can be embedded in the parent HTML document or retrieved through an active database connection. Here is a list:

imageURL: The URL of the main image to be viewed. Image should be in jpg format, and 360 images need to be seamlessly wrappable.

HorzDegrees: Span of the image, in degrees. If it is a full wraparound image then the horizontal degrees would be 360.

VertDegrees: Height of the image, in degrees. If it covers an area from straight up to straight down then the degrees would be 180.

HorzView: The default viewing direction in degrees, measured from left side of image.



Lorraine Christine Hoffman, Esq.
Assistant Staff Counsel
The Florida Bar
File No. 2003-51, 109(15C)

Now comes the draft agreement drafted by Wheeler and Proskauer Rose LLP.



Lorraine Christine Hoffman, Esq.
Assistant Staff Counsel
The Florida Bar
File No. 2003-51, 109(15C)

2255 Glades Road
Suite 340 West
Boca Raton, FL 33431-7360
Telephone 561.241.7400
Elsewhere in Florida
800.432.7746
Fax 561.241.7145

NEW YORK
LOS ANGELES
WASHINGTON
NEWARK
PARIS

PROSKAUER ROSE LLP

Memorandum

VIA HAND DELIVERY

To: Brian G. Utley
From: Mara Lerner Robbins *mlr*
Re: Ryjo, Inc. Web Site Development Agreement
Date: April 18, 2000
Client-Matter: 40017.001

Pursuant to your request, attached please find an initial draft of the Web Site Development Agreement between iviewit.com, Inc. and Ryjo, Inc. (the "Agreement"). Please note that the Agreement contains a number of provisions which have been [bracketed] for further discussion. Once you have had an opportunity to review the Agreement, please call me to discuss and finalize.

Thank you.

cc: Christopher C. Wheeler, Esq.
Donald E. "Rocky" Thompson, II, Esq.

4708/40017-001 BRLIB1/262040 v1

04/18/00 10:03 AM (2761)



Lorraine Christine Hoffman, Esq.
Assistant Staff Counsel
The Florida Bar
File No. 2003-51, 109(15C)

DRAFT — FOR DISCUSSION PURPOSES ONLY

WEB SITE DEVELOPMENT AGREEMENT

This Web Site Development Agreement (the "Agreement"), made and entered into as of the ____ day of _____, 2000 (the "Effective Date") by and between iviewit.com, Inc., a Delaware corporation with offices at 2255 Glades Road, Suite 337 West, Boca Raton, Florida 33431, ("Customer") and Ryjo, Inc., a _____ corporation with offices at _____ ("Developer").

BACKGROUND

WHEREAS, Customer currently owns a Web Site at the URL www.iviewit.com (the "Site");

WHEREAS, Developer is in the business of providing Web site design, development and related services and wishes to further design for Customer the Site and Customer wishes to retain Developer to provide such services, all subject to the terms and conditions set forth in this Agreement.

NOW, THEREFORE, in consideration of the foregoing premises and the mutual promises set forth herein, and for other good and valuable consideration, the receipt and adequacy of which are hereby acknowledged, Customer and Developer hereby agree as follows:

1. Services

1.1 **Initial Services.** Developer shall provide to Customer the services, the Site and the other deliverables set forth on Exhibit A, all in accordance with the specifications and delivery schedule also set forth on Exhibit A hereto (the "Initial Services").

1.2 **Additional Services.** If Customer so requests, Developer shall perform services in addition to the Initial Services. Developer and Customer agree that any services in addition to the Initial Services to be provided by Developer to Customer shall be (i) described in attachments which are executed from time to time by both parties and annexed to and made a part of this Agreement (the "Attachments"); and (ii) provided in accordance with the provisions of this Agreement (the "Additional Services"). Each Attachment shall contain a description of the Additional Services and deliverables to be provided by Developer, criteria and warranties for the Additional Services, specifications, functionality, fees and charges and additional terms and conditions as the parties may wish to include. The Initial Services and Additional Services shall be collectively referred to herein as the "Services" and the deliverables to be provided by Developer pursuant to Initial Services or Additional Services shall be collectively referred to herein as the "Deliverables."

1.3 **Subcontractors.** Developer shall not use any subcontractors unless expressly authorized by Customer in advance and in writing. In the event Customer authorizes Developer's use of a subcontractor, prior to the time such subcontractor commences work on the Services, Developer



Lorraine Christine Hoffman, Esq.
Assistant Staff Counsel
The Florida Bar
File No. 2003-51, 109(15C)

DRAFT — FOR DISCUSSION PURPOSES ONLY

shall ensure that each such subcontractor executes such documents as Customer may reasonably request in order to further the purposes of this Agreement.

2. Compensation

2.1 **Initial Fees.** Customer shall pay Developer fees for the Initial Services, in the amount and at such time as set forth on Exhibit B hereto. Developer acknowledges and agrees that Customer has already paid Developer _____ (\$_____) for Initial Services rendered prior to _____, 2000. **[WILL THERE BE STAGGERED PAYMENTS, WITH PAYMENTS BASED ON MEETING PARTICULAR DEVELOPMENT MILESTONES OR WILL THE PAYMENTS BE BASED UPON HOURLY CHARGES? THIS SHOULD BE SET FORTH IN EXHIBIT B.]**

2.2 **Fees for Additional Services.** In the event Customer requests any Additional Services, Customer shall pay to Developer fees based on [the applicable hourly rate], as set forth in Exhibit C.

2.3 **Expenses.** Developer will not be reimbursed by Customer for any expenses incurred in connection with the performance of the Services, unless those expenses are approved in advance and in writing by Customer.

2.4 **Third Party Software.** Any third party software that Customer will require for the operation of the Site is set forth on Exhibit A or the applicable Attachment. Customer shall not be responsible for reimbursing Developer for the cost of any third party software and all licenses for third party software shall be purchased by Customer directly (with the reasonable assistance of Developer), unless otherwise agreed in writing.

2.5 **Invoicing.** Developer shall invoice Customer monthly for fees for Additional Services, as well as any approved expenses accrued during the prior month. Customer shall pay undisputed fees and expenses within thirty (30) days of receipt of each invoice.

2.6 **Further Revenues; Attribution.** Except as otherwise provided in Section 4.3 below, Developer shall have no right to any royalties, revenues, fees or other payments in connection with, or as a result of, the Site, or with respect to products or services promoted on or by the Site.

3. Development, Deliverables and Acceptance

3.1 **Development.** Developer shall develop each Deliverable in accordance with the applicable Specifications. All development work will be performed by Developer or its employees. Each week following execution of this Agreement during which any development and/or testing hereunder remains uncompleted, and whenever else Customer shall reasonably request, Developer shall contact, or meet with [Eliot I. Bernstein] or another representative designated by Customer, and report all tasks completed and problems encountered relating to development and testing of the Site. During each such discussion or meeting, Developer shall advise Customer in detail of any



Lorraine Christine Hoffman, Esq.
Assistant Staff Counsel
The Florida Bar
File No. 2003-51, 109(15C)

DRAFT — FOR DISCUSSION PURPOSES ONLY

recommended changes with respect to remaining phases of development. Developer shall contact Customer's representative promptly by telephone and in writing upon discovery of any event or problem that might materially delay development work. All interim versions of the Customer Site and Deliverables shall be made available to Customer at all times, upon request of Customer.

3.2 Delivery and Acceptance. Developer shall deliver each Deliverable to Customer on or prior to the delivery date set forth in the delivery schedule in the applicable Exhibit or Attachment. Each delivery shall be in a format or medium acceptable to both parties or as specified in the applicable Exhibit or Attachment. Deliverables shall conform in all material respects to the Specifications and shall be subject to acceptance by Customer in Customer's sole but reasonable discretion. Upon receipt of each Deliverable (including the final Site), Customer shall have a period of [ten (10) days] within which to test the Deliverable (the "Acceptance Period") and to notify Developer of its acceptance or rejection based on its test results with respect thereto. If Customer has not given notice of rejection within the Acceptance Period, the Deliverable will be deemed to have been accepted. In the event that any Deliverable or any portion thereof is not acceptable to Customer, Customer shall give Developer notice thereof. Developer shall, at no cost to Customer, within five (5) days of receipt of such written rejection notice, correct any deficiencies identified by Customer and the delivery/acceptance/rejection/correction provisions above shall be reapplied until the Deliverable is accepted by Customer. If the Deliverable is not acceptable to Customer after Developer has had two opportunities to correct any identified deficiencies, Customer shall have the right to immediately terminate this Agreement without any further obligation or liability of any kind and Developer shall immediately reimburse Customer for any amounts paid hereunder.

3.3 Transfer of Site. Upon acceptance of the Site, Developer shall transfer and implement the Site and any corresponding Deliverables to and on the host Internet server and supporting environment at the location specified in writing by Customer (collectively, the "Host Server") in conformance with the delivery schedule on Exhibit A. The Site will be hosted on the Host Server or as otherwise specified by Customer (the "Hosting Service Provider"). Developer shall work in conjunction with the Hosting Service Provider in connection with the transfer of the Customer Site to the Host Server, provided that Developer shall have ultimate responsibility for effecting the transfer of the Site to the Host Server. Developer shall promptly inform Customer of any known failure by the Hosting Service Provider to assist Developer in effecting such transfer. **[THIS ASSUMES DEVELOPER WILL NOT BE PROVIDING HOSTING SERVICES. PLEASE LET ME KNOW IF THIS IS NOT THE CASE.]**

4. *Proprietary Rights*

4.1 Customer Materials. Except as provided in Section 4.2 and 4.3 below, all Specifications set forth on Exhibit A or in other Attachments, Deliverables (including, but not limited to, the Site) and any inventions, trade secrets, and other materials developed or prepared for Customer by Developer hereunder and any trademarks, trade names, logos, characters, content and other materials provided by Customer ("Customer Content"), and the look and feel of the Site, including, without limitation, all patent rights, copyrights, trademarks, trade names and other proprietary rights inherent



Lorraine Christine Hoffman, Esq.
Assistant Staff Counsel
The Florida Bar
File No. 2003-51, 109(15C)

DRAFT — FOR DISCUSSION PURPOSES ONLY

therein or appurtenant thereto (collectively, the “Customer Materials”) are the property of Customer. All Customer Materials that are copyright works shall be deemed to be works made for hire to the extent permissible under the federal copyright laws. To the extent that any such copyright work may not be considered works made for hire, and generally in relation to all other Customer Materials, Developer agrees to and hereby does irrevocably assign, convey and otherwise transfer to Customer, and its respective successors and assigns, all rights, title and interests worldwide in and to the Deliverables and other materials developed or prepared hereunder and all copyrights, trade secrets, patents, trademarks and other intellectual property rights and all contract and licensing rights, and all claims and causes of action of any kind with respect to any of the foregoing, whether now known or hereafter to become known. Developer agrees to give Customer and any persons designated by Customer reasonable assistance required to perfect the rights defined in this Section 4. Any assignment of copyright hereunder includes all rights of paternity, integrity, disclosure and withdrawal and any other rights that may be known as or referred to as “moral rights” (collectively “Moral Rights”). To the extent such Moral Rights cannot be assigned under applicable law and to the extent the following is allowed by the laws in the various countries where Moral Rights exist, Developer hereby waives such Moral Rights. Developer shall confirm any such waivers and consents from time to time as requested by Customer.

4.2 Retained Rights.

(a) The parties acknowledge that the Site to be delivered to Customer by Developer hereunder will be a compilation of various components, which may include, without limitation, graphics, diagrams, images, tables, sounds, video, computer programs, algorithms, cookies or applets that were created or licensed by Developer prior to the Effective Date (collectively “Developer Software”). Subject to the license granted under (b) below and subject to Section 4.3 below, Developer retains all right, title and interest to Developer Software.

(b) Developer hereby grants to Customer a royalty-free, worldwide, perpetual, irrevocable, non-exclusive license with full rights to sublicense, to use, reproduce, distribute, modify, publicly perform, and publicly display the Developer Software on the Site or any Web site operated by or for Customer.

4.3 Joint Ownership of Java Applet. The parties acknowledge that Developer created and developed, on behalf of Customer, a Java applet which allows for the zooming and panning of JPEG images (the “Java Applet”). The parties acknowledge that the Java Applet was created by Developer specifically for use in connection with its services hereunder. The parties agree that Customer shall not be responsible for reimbursing Developer for the cost of creating such Java Applet or otherwise. The parties further agree that the Java Applet is owned jointly by the parties, and each of the Customer and the Developer own one-half of all rights, title and interest in and to the Java Applet. Any and all inventions, royalties, revenues, trade secrets, trademarks, trade names, logos, patent rights, copyrights and all other proprietary rights inherent in the Java Applet or appurtenant thereto shall be owned one-half by Customer and one-half by Developer.



Lorraine Christine Hoffman, Esq.
Assistant Staff Counsel
The Florida Bar
File No. 2003-51, 109(15C)

DRAFT — FOR DISCUSSION PURPOSES ONLY

4.4 Domain Name. The Customer Site shall have its URL under Customer's domain name, which domain name is and shall remain the sole property of Customer (the "Domain Name"). To the extent that title to the Domain Name does not vest in Customer by operation of law, Developer hereby assigns all rights, title and interest to Customer which Developer has, may have, or may hereafter have, if any, in and to the Domain Names. Developer shall promptly, upon Customer's request, execute any documents and submit any documents to Network Solutions, Inc. and/or another agency which are necessary to give full force and effect to the foregoing assignment.

4.5 Data. Any and all data generated in connection with the testing or operation of the Site shall be solely owned by Customer. Developer shall have no rights to access, use or analyze such data, either individually or in aggregated form.

5. *Confidentiality*

5.1 Confidential Information. The existence and terms of this Agreement, the Deliverables, and any inventions, trade secrets, and other materials developed or prepared for Customer by Developer hereunder and any technical and marketing plans of Customer or any of its affiliates, including without limitation, iviewit Holdings, Inc. ("Holdings") and iviewit Technologies, Inc. ("Technologies") (Holdings, Technologies and any other affiliate of Customer, an "Affiliate" and collectively the "Affiliates") or any other business information of Customer or any Affiliate, including all materials containing said information, which are supplied by Customer to Developer is the confidential information ("Confidential Information") of Customer or any of the Affiliates, as applicable.

5.2 Restrictions on Use. Developer agrees to use the Confidential Information only in furtherance of its obligations under this Agreement and that except as authorized in writing by Customer: (i) Developer will preserve and protect the confidentiality of all Confidential Information; (ii) Developer will not disclose to any third party, the existence, source, content or substance of the Confidential Information or make copies of the Confidential Information; (iii) Developer will not deliver Confidential Information to any third party, or permit the Confidential Information to be removed from Developer's premises; (iv) Developer will not use the Confidential Information in any way other than to develop the Site as provided in this Agreement; (v) Developer will not disclose, use or copy any third party information or materials received in confidence by Developer for purposes of work performed under this Agreement; and (vi) Developer shall require that each of its employees and approved contractors who work on or have access to the Confidential Information sign a confidentiality and assignment agreement acceptable to Customer and be advised of the confidentiality and other applicable provisions of this Agreement.

5.3 Limitations. Information shall not be considered to be Confidential Information if Developer can demonstrate that it: (i) is already or otherwise becomes publicly known through no act of Developer; (ii) is lawfully received from third parties subject to no restriction of confidentiality; (iii) can be shown by Developer to have been independently developed by it without



Lorraine Christine Hoffman, Esq.
Assistant Staff Counsel
The Florida Bar
File No. 2003-51, 109(15C)

DRAFT — FOR DISCUSSION PURPOSES ONLY

use of the Confidential Information; or (iv) is authorized in writing by Customer to be disclosed, copied or used.

5.4 Return of Customer Materials. Upon Customer's acceptance of the final Deliverable, or upon Customer's earlier request, Developer shall provide Customer with all copies and originals of Customer Materials, Developer's work papers and work in progress as well as any other materials provided to Developer, or created by Developer under this Agreement.

6. Non-Competition. Developer shall not, during the Term of this Agreement and for a period of ____ () years thereafter, for any reason, directly or indirectly, do any of the following: (i) perform services for any of those entities named by Customer as Customer's direct competitors; (ii) design, develop or provide services in connection with a site that Customer believes is competitive with the Site or which incorporates the following aspects or functionality also found in the Site: _____; or (iii) solicit the trade or patronage, conspire with any individual, partnership, company, employer, or business entity with which Customer is actively involved in a way which causes harm to the Customer and its objectives.

[DOES THE COMPANY WANT A NON-COMPETE PROVISION?]

7. Warranties, Covenants and Indemnification

7.1 Developer Warranty. Developer warrants and represents that the Deliverables and the Site (1) will be of high quality and free of defects in material and workmanship in all material respects; (2) will function and conform in all material respects to the functional and other descriptions contained on Exhibit A or other Attachments; and (4) shall not infringe upon or misappropriate any copyright, trademark, patent, trade secret or other third party right. Developer agrees to fix at its own expense any failure of any Deliverable or the Site to meet the foregoing warranty. [At no cost to Customer, Developer shall fully cooperate with Customer and any Hosting Service Provider in providing the Services under this Agreement, including, but not limited to, implementing the Site on the Host Server and identifying and correcting any errors in the Site.]

7.2 Customer Warranty. Customer shall be responsible for Customer Content provided by Customer and for complying with laws applicable to Customer's business. Customer shall be responsible for paying taxes relating to the Site and related electronic commerce.

7.3 Developer's Indemnity. Developer agrees to defend, indemnify, and hold harmless Customer and its directors, officers, employees and agents from and against all claims, defense costs (including reasonable attorneys' fees), judgments and other expenses arising out of or in connection with (i) a breach by Developer of its covenants and warranties in this Agreement or (ii) any claim or threat by a third party that the Deliverables or the Site infringe upon or misappropriate any copyright, trademark, patent, trade secret or other third party right.



Lorraine Christine Hoffman, Esq.
Assistant Staff Counsel
The Florida Bar
File No. 2003-51, 109(15C)

DRAFT — FOR DISCUSSION PURPOSES ONLY

7.4 Obligations Relating to Developer Indemnity. Developer's obligation to indemnify requires that Customer notify Developer promptly of any claim as to which indemnification will be sought and provide Developer with the right to solely defend and settle such claim, with the reasonable assistance of Customer.

7.7 DISCLAIMER. THE WARRANTIES EXPRESSLY SET FORTH IN THIS AGREEMENT ARE LIMITED WARRANTIES AND ARE THE ONLY WARRANTIES MADE BY THE PARTIES. THE PARTIES EXPRESSLY DISCLAIM, AND HEREBY EXPRESSLY WAIVE, ALL OTHER WARRANTIES, EXPRESS OR IMPLIED, INCLUDING, WITHOUT LIMITATION, WARRANTIES OF MERCHANTABILITY AND FITNESS FOR A PARTICULAR PURPOSE.

7.8 EXCLUSION. NEITHER PARTY SHALL BE LIABLE TO THE OTHER PARTY FOR ANY INCIDENTAL OR CONSEQUENTIAL DAMAGES, EVEN IF IT HAS BEEN ADVISED OF THE POSSIBILITY OF SUCH DAMAGES.

8. Termination

8.1 Termination for Convenience. Customer shall have the right at any time to terminate this Agreement upon [twenty (20)] days notice by giving written notice of termination to Developer.

8.2 Termination for Non-Performance or Delay. In addition to Customer's rights to terminate this Agreement for cause pursuant to Section 3.2, Customer shall have the right to terminate this Agreement effective immediately if a Deliverable is [____ ()] or more days late. **[PLEASE ADVISE AS TO APPROPRIATE TIME PERIOD.]**

8.3 Automatic Termination. This Agreement will be terminated automatically, without notice, (i) upon the institution by or against Developer of insolvency, receivership, or bankruptcy proceedings or any other proceedings for the settlement of Developer's debts; (ii) upon Developer making an assignment for the benefit of creditors; or (iii) upon Developer's dissolution.

8.4 Effect of Termination. In the event of termination of this Agreement for any reason, Developer shall immediately cease all work hereunder. Customer will have no further obligations or liabilities under this Agreement other than to pay Developer for fees accrued up to the time of termination. Customer will have the right, in addition to all of its other rights, to require Developer to deliver to Customer all of Developer's work in progress, including all originals and copies thereof; as well as any Customer Materials and other materials provided to Developer by Customer or third parties, or created by Developer under this Agreement, including the Java Applet. Developer may keep any payments which have been paid or are due, and such payments shall be deemed payment in full for all obligations of Customer under this Agreement, including full payment for all source code, object code, documentation, notes, graphics and all other materials and work relating to the portion of the Site and the assignment or licenses of rights relating to the Site which has been completed as of the time of termination. Developer shall provide reasonable assistance to Customer



Lorraine Christine Hoffman, Esq.
Assistant Staff Counsel
The Florida Bar
File No. 2003-51, 109(15C)

DRAFT — FOR DISCUSSION PURPOSES ONLY

and any third parties authorized by Customer in assuming performance of those Services necessary for the continued and uninterrupted operation of the Site. Upon termination or expiration of this Agreement, Developer shall, at no cost to Customer, provide reasonable assistance to Customer and any third parties authorized by Customer in assuming performance of those Services necessary for the continued and uninterrupted operation of the Customer Site.

9. Miscellaneous

9.1 Independent Contractors. The parties agree that their relationship is strictly and solely that of independent contractors, and that neither Developer nor any of its employees, agents or representatives is or shall be construed as an employee of Customer, or otherwise entitled to any benefits or insurance provided by Customer, including any unemployment or disability benefits.

9.2 Assignment. Neither party may assign this Agreement or any of its rights or obligations hereunder without the prior written consent of the other party. This Agreement shall be binding upon the parties' respective successors and permitted assigns.

9.3 Notices. Any notices or communication under this Agreement shall be in writing and shall be hand delivered or sent by registered mail return receipt requested or by confirmed facsimile transmission to the party receiving such communication at the address specified above or such other address as either party may in the future specify to the other party. Notices shall be deemed to be effective upon confirmation of delivery.

9.4 Amendments. No modification, amendment, supplement to or waiver of this Agreement, Exhibit, Schedule or Attachment, or any of their provisions shall be binding upon the parties unless made in writing and duly signed by both parties. A failure of either party to exercise any right provided for herein, shall not be deemed to be a waiver of any right hereunder.

9.5 Entire Agreement. This Agreement, Exhibits, Schedules and any Attachments set forth the entire understanding of the parties as to the subject matter therein and may not be modified except in a writing executed by both parties. In the event of a conflict between the terms of this Agreement and the terms of an Exhibit, Schedule or Attachments, the terms of this Agreement shall control. In the event any one or more of the provisions of this Agreement, Exhibit, Schedule or Attachments is invalid or otherwise unenforceable, the enforceability of the remaining provisions shall remain unimpaired and in full force and effect.

9.6 Publicity. Developer agrees that it shall not, without prior written consent of Customer in each instance, refer to the existence of this Agreement on its Web site, in press releases, advertising or materials distributed to prospective clients without the prior written consent of Customer, which consent shall not be unreasonably withheld.

9.7 Governing Law. This Agreement shall be governed by the laws of the State of Florida, without giving effect to conflicts of laws principles.



Lorraine Christine Hoffman, Esq.
Assistant Staff Counsel
The Florida Bar
File No. 2003-51, 109(15C)

DRAFT — FOR DISCUSSION PURPOSES ONLY

9.8 Survival. Sections 4, 5, 6 and 7 of this Agreement shall survive the expiration or termination of this Agreement.

IN WITNESS WHEREOF, the parties hereto have executed this Agreement as of the day and year first above written.

CUSTOMER:

iviewit.com, Inc.

By: _____

Title: _____

DEVELOPER:

Ryjo, Inc.

By: _____

Title: _____



Lorraine Christine Hoffman, Esq.
Assistant Staff Counsel
The Florida Bar
File No. 2003-51, 109(15C)

DRAFT — FOR DISCUSSION PURPOSES ONLY

EXHIBIT A

INITIAL SERVICES

Services
Deliverables
Delivery Schedule
Specifications
Applicable third party software
Plans to transfer Site to Host Provider



Lorraine Christine Hoffman, Esq.
Assistant Staff Counsel
The Florida Bar
File No. 2003-51, 109(15C)

DRAFT — FOR DISCUSSION PURPOSES ONLY

EXHIBIT B

INITIAL FEES



Lorraine Christine Hoffman, Esq.
Assistant Staff Counsel
The Florida Bar
File No. 2003-51, 109(15C)

DRAFT — FOR DISCUSSION PURPOSES ONLY

EXHIBIT C

HOURLY RATES FOR ADDITIONAL SERVICES



Lorraine Christine Hoffman, Esq.
Assistant Staff Counsel
The Florida Bar
File No. 2003-51, 109(15C)

WEB SITE DEVELOPMENT AGREEMENT

THIS WEB SITE DEVELOPMENT AGREEMENT (the "Agreement"), made and entered into as of the _____ day of _____, _____ (the "Effective Date") by and between Iviewit.com, Inc., a Delaware corporation having offices at 2255 Glades Road, Suite 337 West, Boca Raton, Florida 33431, ("Customer") and Ryjo, Inc., a(n) _____ corporation with offices at _____ ("Developer").

WHEREAS, Customer currently owns a Web Site having a URL of "www.iviewit.com" (the "Site");

WHEREAS, Developer is in the business of providing Web site design, development, and related services, and wishes to further design the Site for Customer, and Customer wishes to retain Developer to provide such services, all subject to the terms and conditions set forth in this Agreement.

NOW, THEREFORE, in consideration of the foregoing premises and the mutual promises set forth herein, and for other good and valuable consideration, the receipt and adequacy of which are hereby acknowledged, Customer and Developer hereby agree as follows:

1. SERVICES

1.1 Initial Services. Developer shall provide to Customer the services and the other deliverables set forth on Exhibit A attached hereto, all in accordance with the specifications ("Specifications") and delivery schedule also set forth on Exhibit A (the "Initial Services").

1.2 Additional Services. If Customer so requests, Developer shall perform services in addition to the Initial Services. Developer and Customer agree that any services in addition to the Initial Services to be provided by Developer to Customer shall be (i) described in attachments which are executed from time to time by both parties and annexed to and made a part of this Agreement (the "Attachments"); and (ii) provided in accordance with the provisions of this Agreement (the "Additional Services"). Each Attachment shall contain a description of the Additional Services and deliverables to be provided by Developer, criteria and warranties for the Additional Services, Specifications, functionality, fees and charges, and additional terms and conditions as the parties may wish to include. The Initial Services and Additional Services shall be collectively referred to herein as the "Services" and the deliverables to be provided by Developer pursuant to Initial Services or Additional Services shall be collectively referred to herein as the "Deliverables."

1.3 Subcontractors. Developer shall not use any subcontractors unless expressly authorized by Customer in advance and in writing. In the event Customer



Lorraine Christine Hoffman, Esq.
Assistant Staff Counsel
The Florida Bar
File No. 2003-51, 109(15C)

authorizes Developer's use of a subcontractor, prior to the time such subcontractor commences work on the Services, Developer shall ensure that each such subcontractor executes such documents as Customer may reasonably request in order to further the purposes of this Agreement.

2. COMPENSATION

2.1 **Initial Fees.** Customer shall pay Developer fees for the Initial Services, in the amount and at such time as set forth on Exhibit B attached hereto.

2.2 **Fees for Additional Services.** In the event Customer requests any Additional Services, Customer shall pay to Developer fees based on the applicable hourly rate as set forth on Exhibit C attached hereto.

2.3 **Expenses.** Developer shall not be reimbursed by Customer for any expenses incurred in connection with the performance of the Services, unless those expenses are approved in advance and in writing by Customer.

2.4 **Third Party Software.** Any third party software that Customer will require for the operation of the Site, but not that which may be included in the Site pursuant to Section 4.2 below, is set forth on Exhibit A or the applicable Attachment. Customer shall not be responsible for reimbursing Developer for the cost of any such third party software, and all licenses for such third party software shall be purchased by Customer directly (with the reasonable assistance of Developer), unless otherwise agreed in writing.

2.5 **Invoicing for Services.** Developer shall invoice Customer monthly for fees for Services, as well as any approved expenses accrued during the prior month. Customer shall pay undisputed fees and expenses within thirty (30) days of receipt of each invoice.

2.6 **Further Revenues; Attribution.** Except as otherwise provided in Section 4.2(b) below, Developer shall have no right to any royalties, revenues, fees, or other payments in connection with, or as a result of, the Site, or with respect to products or services promoted on or by the Site.

3. DEVELOPMENT, DELIVERABLES, AND ACCEPTANCE

3.1 **Development.** Developer shall develop, test, and provide each Deliverable in accordance with the applicable Specifications. All development work will be performed by Developer or its employees. Each week following execution of this Agreement during which any development and/or testing hereunder remains uncompleted, and whenever else Customer shall reasonably request, Developer shall contact or meet with Brian G. Utley, Eliot I. Bernstein, or another representative designated by Customer, and report all tasks completed and problems encountered relating to development and testing of the Site. During each such discussion or meeting, Developer shall advise Customer in detail of any recommended changes with respect to

-2-

001.788135.5



Lorraine Christine Hoffman, Esq.
Assistant Staff Counsel
The Florida Bar
File No. 2003-51, 109(15C)

remaining phases of development. Developer shall contact Customer's representative promptly by telephone and in writing upon discovery of any event or problem that might materially delay development work. All interim versions of the Customer Site and Deliverables shall be made available to Customer at all times, upon request of Customer.

3.2 Delivery and Acceptance. Developer shall deliver each Deliverable to Customer on or before the delivery date set forth in the delivery schedule in the applicable Exhibit or Attachment. Each delivery shall be in a format or medium acceptable to both parties or as specified in the applicable Exhibit or Attachment. Deliverables shall conform in all material respects to the Specifications and shall be subject to acceptance by Customer in Customer's sole but reasonable discretion. Upon receipt of each Deliverable (including the final Site), Customer shall have a period of ten (10) days within which to test the Deliverable (the "Acceptance Period") and to notify Developer of its acceptance or rejection based on its test results with respect thereto. If Customer has not given notice of rejection within the Acceptance Period, the Deliverable will be deemed to have been accepted. In the event that any Deliverable or any portion thereof is not acceptable to Customer, Customer shall give Developer notice thereof. Developer shall, at no cost to Customer, within five (5) days of receipt of such written rejection notice, correct any deficiencies identified by Customer, and the delivery/acceptance/rejection/correction provisions above shall be reapplied until the Deliverable is accepted by Customer. If the Deliverable is not acceptable to Customer after Developer has had two opportunities to correct any identified deficiencies, Customer shall have the right to immediately terminate this Agreement without any further obligation or liability of any kind, and Developer shall immediately reimburse Customer for any amounts paid for that portion of the Deliverables that are affected by such uncorrected deficiencies as determined in Customer's sole but reasonable discretion.

3.3 Transfer of Site. Upon acceptance of the Deliverables, Developer shall transfer and implement the Site and any corresponding Deliverables to and on the host Internet server and supporting environment at the location specified in writing by Customer (collectively, the "Host Server") in conformance with the delivery schedule set forth on Exhibit A. The Site will be hosted on the Host Server or as otherwise specified by Customer (the "Hosting Service Provider"). Developer shall work in conjunction with the Hosting Service Provider in connection with the transfer of the Customer Site to the Host Server, provided that Developer shall have ultimate responsibility for effecting the transfer of the Site to the Host Server. Developer shall promptly inform Customer of any known failure by the Hosting Service Provider to assist Developer in effecting such transfer.

4. PROPRIETARY RIGHTS

4.1 Customer Materials. Except as provided in Section 4.2 below, all Deliverables, source code for the Deliverables, and other materials developed or prepared for Customer by Developer hereunder, and all Specifications, documents, words, symbols, names, logos, characters, literary content, and other materials provided by



Lorraine Christine Hoffman, Esq.
Assistant Staff Counsel
The Florida Bar
File No. 2003-51, 109(15C)

Customer to Developer, and all inventions, patents, copyrights, trademarks, trade secrets, and other proprietary rights in all of the foregoing, including but not limited to the resulting “look and feel” of the Site (collectively, the “Customer Materials”), are the property of Customer. Any and all Customer Materials that are copyrightable works authored by Developer shall be deemed to be a “work made for hire” to the extent permissible under the U.S. Copyright laws. To the extent that any such copyrightable work may not be considered a “work made for hire” under the U.S. Copyright laws, and further with respect to all other Customer Materials, Developer agrees to and hereby does irrevocably assign, convey, and otherwise transfer to Customer, and its respective successors and assigns, all of Developers’ right, title, and interest worldwide in and to the Customer Materials, including all inventions, patents, copyrights, trade secrets, trademarks, and other proprietary rights and all contract and licensing rights therein, and all claims and causes of action of any kind with respect to any of the foregoing, whether now known or hereafter to become known. Developer agrees to give Customer and any persons designated by Customer reasonable assistance required to perfect the rights defined in this Section 4. Any assignment of copyright hereunder includes all rights of attribution, integrity, disclosure, and withdrawal, and any other rights under 17 U.S.C. § 106A, and any other rights that may be known as or referred to as “moral rights” (collectively “Moral Rights”). To the extent such Moral Rights cannot be assigned under applicable law and to the extent the following is allowed by the laws in the various countries where Moral Rights exist, Developer hereby waives such Moral Rights. Developer shall confirm any such waivers and consents from time to time as requested by Customer.

4.2 Retained Rights.

(a) The parties acknowledge that the Deliverables will be a compilation of various components, which may include, without limitation, graphics, diagrams, images, tables, sounds, video, computer programs, algorithms, cookies, or applets that were created or licensed by Developer prior to the Effective Date (collectively “Developer Software”). Subject to the license granted under Subsection (b) below, Developer retains all right, title, and interest in and to the Developer Software.

(b) Developer hereby grants to Customer a royalty-free, worldwide, perpetual, irrevocable, non-exclusive right and license, with full rights to sublicense, to make, have made, use, offer for sale, sell, import, reproduce, distribute, modify, publicly perform, and publicly display the Developer Software.

4.3 Ownership of Java Applet.

(a) The parties acknowledge that Developer developed, on behalf of Customer, the Java computer program task-specific application “applet” that facilitates zooming and panning of JPEG images (the “Java Applet”). The parties further acknowledge that the Java Applet is part of the Deliverables hereunder



Lorraine Christine Hoffman, Esq.
Assistant Staff Counsel
The Florida Bar
File No. 2003-51, 109(15C)

and does not include Developer Software. Customer shall pay Developer for the cost of developing the Java Applet in the amount set forth on Exhibit D attached hereto. The Java Applet is the exclusive property of Customer, as it is part of the Customer Materials set forth in Section 4.1 above. Subject to the license granted under Subsection (b) below, Customer retains all right, title, and interest in and to the Java Applet.

(b) Customer hereby grants to Developer a royalty-free, worldwide, perpetual, irrevocable, non-exclusive right and license, with full rights to sublicense, to make, have made, use, offer for sale, sell, import, reproduce, distribute, modify, publicly perform, and publicly display the Java Applet.

4.4 Domain Name. The Customer Site shall have its URL under Customer's domain name(s), which domain names is/are and shall remain the sole property of Customer (the "Domain Name"). To the extent that title to the Domain Name does not vest in Customer by operation of law, Developer hereby assigns all right, title, and interest to Customer which Developer has, may have, or may hereafter have, if any, in and to the Domain Name. Developer shall promptly, upon Customer's request, execute any documents and submit any documents to Network Solutions, Inc. and/or another agency that are necessary to give full force and effect to the foregoing assignment.

4.5 Data. Any and all data generated in connection with the testing or operation of the Site shall be solely owned by Customer. Developer shall have no rights to access, use, or analyze such data, either individually or in aggregated form.

5. CONFIDENTIALITY

5.1 Confidential Information.

(a) An "Affiliate" shall mean any company or entity that controls, is controlled by, or is under common control with, Customer at the time in question, and specifically includes Iviewit Holdings, Inc., Iviewit Technologies, Inc., and Iviewit LLC.

(b) "Confidential Information" shall mean all information and material: (a) that gives Customer or its Affiliates some competitive business advantage or the opportunity of obtaining such advantage or the disclosure of which could be detrimental to the interests of Customer or its Affiliates; or (b) that is either (i) marked "Confidential", "Restricted", or "Proprietary" or other similar marking, or (ii) known by the Developer to be considered confidential or proprietary to Customer or its Affiliates, or (iii) from all the relevant circumstances, should reasonably be assumed to be confidential or proprietary to Customer or its Affiliates. Confidential Information includes, but is not limited to, information concerning the business, customers, markets, products, technology, operations, financial structure, and assets of Customer or its Affiliates, and specifically



Lorraine Christine Hoffman, Esq.
Assistant Staff Counsel
The Florida Bar
File No. 2003-51, 109(15C)

includes such items as customer and vendor lists, employee lists, financial and business data, technical, engineering, and research and development information, market research and analysis data, inventions, trade secrets, and know-how.

5.2 Restrictions on Disclosure and Use. Developer acknowledges that in order to perform the Services hereunder, it shall be necessary for Customer to disclose to Developer certain Confidential Information. Developer agrees that, unless it has obtained express prior written consent from a duly authorized representative of Customer to do otherwise, it shall: (i) treat as confidential and protect the secrecy of any Confidential Information in Developer's possession or control; (ii) not disclose, publish, or otherwise make the existence, source, content, or substance of any Confidential Information available or known to the public or to any third party; and (iii) not use any Confidential Information for the benefit of any person or organization, including Developer, except as and to the extent necessary for the purpose of performance under this Agreement.

5.3 Exceptions. Customer agrees that the obligations of confidentiality under this Agreement shall not apply to any portion of the Confidential Information that Developer can show by substantial documentary evidence: (a) was in Developer's possession or previously known to Developer, without an obligation to keep it confidential, before such information was disclosed to Developer by Customer or developed for Customer by Developer; or (b) is or becomes public knowledge through a source other than Developer and through no fault of Developer; or (c) is or becomes lawfully available to Developer from a source other than Customer and was not derived from the Confidential Information; or (d) is independently developed by employees or agents of Developer that did not have access to any Confidential Information; or (e) is required to be produced under a court or governmental order, in which event Developer shall provide reasonable prior notification to Customer so that Customer may take steps necessary to protect its Confidential Information.

5.4 Return of Customer Materials. Upon Customer's acceptance of the final Deliverables, or upon Customer's earlier request, Developer shall provide Customer with all originals and copies of all Confidential Information in tangible form, Customer Materials, Developer's work papers and work-in-progress, as well as any other materials provided to Developer or created by Developer under this Agreement.

6. WARRANTIES, COVENANTS, AND INDEMNIFICATION

6.1 Developer Warranty. Developer represents and warrants that:

- (a) the Deliverables and the Site will be free of defects in materials and workmanship in all material respects;



Lorraine Christine Hoffman, Esq.
Assistant Staff Counsel
The Florida Bar
File No. 2003-51, 109(15C)

(b) the Deliverables and the Site will function and conform in all material respects to the Specifications and other descriptions set forth on Exhibit A or other Attachments;

(c) all works of authorship in the Deliverables are original and have not been copied or derived from a third party's work, except to the extent Developer Software is included in the Deliverables as authorized under this Agreement;

(d) the Deliverables and the Site shall not infringe upon or misappropriate any copyright, trademark, patent, trade secret, or other third party right;

(e) unless Developer has obtained express prior written consent from a duly authorized representative of Customer to do otherwise, only those persons that are full-time employees of Developer acting within the scope of their employment shall perform Services for Customer under this Agreement, such that all copyrightable subject matter made by those persons will be covered by the definition of a "work made for hire" under the U.S. Copyright laws and Developer will be regarded as the author and owner of all copyrights in any such works;

(f) unless Developer has obtained express prior written consent from a duly authorized representative of Customer to do otherwise, only those persons that have (i) executed an invention assignment agreement in favor of Developer, and (ii) have executed a confidentiality agreement with Developer consistent with the obligations of Developer under this Agreement, shall perform Services for Customer;

(g) Developer either owns or has the right to license the Deliverables provided to Customer under this Agreement, including any Developer Software used in the Deliverables, and Developer shall not include or use any materials or other technology in the Deliverables that would conflict with Developer's obligations under this Agreement;

(h) Developer will not disclose to Customer, nor make use of during the Services provided hereunder, any trade secrets or other proprietary information of any third party, unless Developer may do so without Developer or Customer incurring any obligation, past or future, to such third party for such work or any future application thereof; and

(i) except to the extent expressly permitted in writing by a duly authorized representative of Customer, no portion of the Deliverables contains or will contain any protection feature designed to prevent its use or to provide unauthorized use, including, without limitation, any computer password, virus, worm, software lock, drop-dead device, Trojan-horse routine, trap door, time



Lorraine Christine Hoffman, Esq.
Assistant Staff Counsel
The Florida Bar
File No. 2003-51, 109(15C)

bomb, or any other codes or instructions that may be used to access, modify, delete, damage, or disable the Deliverables or the Site or Customer's or its client's use thereof.

6.2 Correction Procedures. Unless otherwise set forth in Section 6.5 below, Developer agrees to correct at its own expense any failure of any Deliverable or the Site to meet the foregoing warranty. Developer shall fully cooperate with Customer and any Hosting Service Provider in providing the Services under this Agreement, including, but not limited to, implementing the Site on the Host Server and identifying and correcting any errors in the Site.

6.3 Indemnity. Developer agrees to defend, indemnify, and hold harmless Customer and its directors, officers, employees and agents from and against all claims, defense costs (including reasonable attorneys' fees), judgments, and other expenses arising out of or in connection with (i) a breach by Developer of its representations and warranties in this Agreement, and (ii) any claim or threat by a third party that the Deliverables or the Site infringe upon or misappropriate any copyright, trademark, patent, trade secret or other third party right.

6.4 Indemnity Obligations. Developer's obligation to indemnify requires that Customer notify Developer promptly of any claim as to which indemnification will be sought, and provide Developer with the right to solely defend and settle any such claim for monetary damages, with the reasonable assistance of Customer and at Developer's sole expense.

6.5 Infringement Procedures. In the event that the use of the Deliverables or the Site infringes or misappropriates any patent, copyright, trademark, trade secret, or other intellectual or industrial property right of any third party, and, as a result therefrom, an action is brought seeking an injunction against Customer to stop using the Deliverables or the Site, either wholly or in part, then Developer shall, at its option and its expense, either: (a) obtain for Customer the right to continue using the Deliverables and the Site; or (b) modify the Deliverables and/or the Site in such a way that they become non-infringing, as long as the modified Deliverables and/or the Site comply with the Specifications and are of comparable quality and functionality.

6.6 DISCLAIMER. THE WARRANTIES EXPRESSLY SET FORTH IN THIS AGREEMENT ARE LIMITED WARRANTIES AND ARE THE ONLY WARRANTIES MADE BY THE PARTIES. THE PARTIES EXPRESSLY DISCLAIM, AND HEREBY EXPRESSLY WAIVE, ALL OTHER WARRANTIES, EXPRESS OR IMPLIED, INCLUDING, WITHOUT LIMITATION, WARRANTIES OF MERCHANTABILITY AND FITNESS FOR A PARTICULAR PURPOSE.

6.7 EXCLUSION. NEITHER PARTY SHALL BE LIABLE TO THE OTHER PARTY FOR ANY INCIDENTAL OR CONSEQUENTIAL DAMAGES, EVEN IF IT HAS BEEN ADVISED OF THE POSSIBILITY OF SUCH DAMAGES.



Lorraine Christine Hoffman, Esq.
Assistant Staff Counsel
The Florida Bar
File No. 2003-51, 109(15C)

6.8 No Liability for Customer. Customer shall have no liability to Developer and Developer shall indemnify and hold Customer harmless from any and all claims for property loss and injury (including death) to Developer and its employees and agents that may result in connection with the performance of Services hereunder, provided that such injuries are not a result of the sole intentional or negligent acts of Customer or its employees.

6.9 No Conflict. Developer represents and warrants that it has no activities or obligations with any third party that will in any way conflict with or limit or restrict Developer's ability to perform the Services for Customer hereunder. In case of doubt, prior to commencing such activities or obligations, Developer will review the area of possible conflict with appropriate representatives of Customer.

6.10 Non-Competition. Developer shall not, during the Term of this Agreement and for a period of three (3) years thereafter, for any reason, directly or indirectly, do any of the following: (i) perform design, development, or consulting services for any person or entity that is in the same business as Customer and that could reasonably be considered a direct competitor of Customer, particularly if such person or entity performs digital imaging and/or streaming video and/or video conferencing services for third parties; and (ii) solicit the trade or patronage of, or conspire with, any individual, partnership, company, employer, or business entity with which Customer is actively involved in a way which causes harm to Customer.

7. TERM AND TERMINATION

7.1 Term. This Agreement shall commence on the Effective Date and shall continue for a minimum period (the "Term") of one (1) year, and shall continue thereafter for so long as the Customer seeks and obtains Services from Developer, unless terminated earlier in accordance with this Agreement.

7.2 Termination for Convenience. Customer shall have the right at any time to immediately terminate this Agreement for any reason by giving written notice of such termination to Developer. Developer shall have the right at any time to terminate this Agreement for any reason by giving ninety (90) days prior written notice of such termination to Customer.

7.3 Automatic Termination. This Agreement shall be terminated automatically, without notice, (i) upon the institution by or against Developer of insolvency, receivership, or bankruptcy proceedings or any other proceedings for the settlement of Developer's debts; (ii) upon Developer making an assignment for the benefit of creditors; or (iii) upon Developer's dissolution.

7.4 Effect of Termination. In the event of termination of this Agreement for any reason, Developer shall immediately cease all work hereunder. Customer will have no further obligations or liabilities under this Agreement other than to pay Developer for



Lorraine Christine Hoffman, Esq.
Assistant Staff Counsel
The Florida Bar
File No. 2003-51, 109(15C)

fees accrued up to the time of termination. Customer will have the right, in addition to all of its other rights, to require Developer to deliver to Customer all of Developer's work in progress, including all originals and copies thereof; as well as any Customer Materials and other materials provided to Developer by Customer or third parties, or created by Developer under this Agreement. Developer may keep any payments which have been paid or are due, and such payments shall be deemed payment in full for all obligations of Customer under this Agreement, including full payment for all source code, object code, documentation, notes, graphics and all other materials and work relating to the portion of the Deliverables and the assignment or licenses of rights relating to the Customer Materials which has been completed as of the time of termination. Upon termination or expiration of this Agreement, Developer shall, at no cost to Customer, provide reasonable assistance to Customer and any third parties authorized by Customer in assuming performance of those Services necessary for the continued and uninterrupted operation of the Site.

8. MISCELLANEOUS

8.1 Independent Contractors. The parties agree that their relationship is strictly and solely that of independent contractors, and that neither Developer nor any of its employees, agents or representatives is or shall be construed as an employee of Customer, or otherwise entitled to any benefits or insurance provided by Customer, including any unemployment or disability benefits.

8.2 Assignment. Neither party may assign this Agreement or any of its rights or obligations hereunder without the prior written consent of the other party; provided, however, that Customer may, upon notice to Developer, assign its rights under this Agreement to any Affiliate of Customer or to the acquirer of substantially all of its business. This Agreement shall be binding upon the parties' respective successors and permitted assigns.

8.3 Notices. Any notices or communication under this Agreement shall be in writing and shall be hand delivered or sent by registered mail return receipt requested or by confirmed facsimile transmission (with copy sent by First Class U.S. Mail) to the party receiving such communication at the address specified above or such other address as either party may in the future specify to the other party. Notices shall be deemed to be effective upon confirmation of delivery.

8.4 Amendments. No modification, amendment, supplement to, or waiver of this Agreement, Exhibit, Attachment, or any of their provisions, shall be binding upon the parties unless made in writing and duly signed by both parties. A failure of either party to exercise any right provided for herein shall not be deemed to be a waiver of any right hereunder.

8.5 Entire Agreement. This Agreement, Exhibits, and any Attachments set forth the entire understanding of the parties as to the subject matter therein and may not



Lorraine Christine Hoffman, Esq.
Assistant Staff Counsel
The Florida Bar
File No. 2003-51, 109(15C)

be modified except in a writing executed by both parties. In the event of a conflict between the terms of this Agreement and the terms of an Exhibit or Attachment, the terms of this Agreement shall control. In the event any one or more of the provisions of this Agreement, Exhibit, or Attachment is invalid or otherwise unenforceable, the enforceability of the remaining provisions shall remain unimpaired and in full force and effect.

8.6 Publicity. Developer agrees that it shall not, without prior written consent of Customer in each instance, refer to the existence of this Agreement on its Web site, in press releases, advertising, or materials distributed to prospective clients, without the prior written consent of Customer.

8.7 Governing Law. This Agreement shall be governed by the laws of the State of Florida, without giving effect to conflicts of laws principles.

8.8 Survival. Sections 4, 5, and 6 of this Agreement shall survive termination or expiration of this Agreement.

IN WITNESS WHEREOF, the parties hereto have executed this Agreement as of the day and year first above written.

CUSTOMER: Iviewit.com, Inc.

By: _____

Printed Name: _____

Title: _____

DEVELOPER: Ryjo, Inc.

By: _____

Printed Name: _____

Title: _____



Lorraine Christine Hoffman, Esq.
Assistant Staff Counsel
The Florida Bar
File No. 2003-51, 109(15C)

When confronted with the fact that in no way did RYJO own our technology, Mr. Bernstein submitted to Foley and Lardner who had just been retained to replace Mr. Joao, the Website Agreement for comments and we submit as evidence the comments that came back from Foley and Lardner, regarding Mr. Wheeler and Mr. Thompson's Website Agreement.



Lorraine Christine Hoffman, Esq.
Assistant Staff Counsel
The Florida Bar
File No. 2003-51, 109(15C)

-----Original Message-----

From: Boehm, Douglas A. [mailto:daboehm@foleylaw.com]
Sent: Monday, May 22, 2000 8:18 PM
To: 'utleyb@aol.com'
Cc: 'Brian Utley (Iviewit)'
Subject: Ryjo Agreement Comments

Brian--

Here's the text of the letter (without the marked up agreement) that is being faxed to you at home.

CONFIDENTIAL
ATTORNEY-CLIENT PRIVILEGED

Mr. Brian G. Utley
President
Iviewit.com, Inc.
One Boca Place
2255 Glades Road, Suite 337 West
Boca Raton, Florida 33431

Re: Ryjo Web Site Development Agreement
Our Ref.: 57103/101

Dear Brian:

I have now had the opportunity to review the draft of the Web Site Development Agreement between Iviewit.com, Inc. ("Customer") and Ryjo, Inc. ("Developer") dated April 18, 2000, that was prepared by the Proskauer Rose law firm. I have attached a hand marked-up copy of the draft agreement to this letter, which contains several comments in the margins. I will limit my discussion in the body of this letter to the substantive matters of the Agreement. Please refer to the attached agreement for additional comments regarding stylistic and formal matters.

Since I was not involved in the initial negotiations with Ryjo, and since I don't have detailed information about the services to be provided, I can only pose questions regarding those parts of the agreement that I don't understand. I apologize if these questions are not relevant to the development or if they have already been dealt with in other communications.

Section 1.1 Initial Services.

The draft agreement states that "Developer shall provide ... the Site ...". Since I suspect that Iviewit already owns the Site (as stated in first whereas clause), I don't understand why "the Site" is set forth here as being provided by the Developer. Furthermore, the bolded note in Section 3.3 assumes that Developer will not be providing hosting services, and asks if this is not the case. Whatever the answer, these two Sections are not consistent.

Since the term "specifications" is capitalized in Section 3.1 and elsewhere to indicate a defined term, Section 1.1 should be modified to define this term: "... all in accordance with the specifications (the "Specifications") and delivery schedule ...".

Note that the specifications are a very important part of any development agreement, particularly since they are the basis for determining whether or not a breach of the agreement has occurred under Sections 3.2 and 7.1. Please be sure that the specifications are accurate and complete.



Lorraine Christine Hoffman, Esq.
Assistant Staff Counsel
The Florida Bar
File No. 2003-51, 109(15C)

Section 2.1 Initial Fee.

If the value of the development Services is sufficient, I recommend that staggered payments be made in accordance with the Developer meeting particular development milestones, as suggested in the bolded note of Section 2.1. If development milestones are used, they should be set forth in detail on Exhibit B and probably take the place of the Delivery Schedule set forth on Exhibit A.

Section 2.4 Third Party Software.

This Section 2.4 refers to third party software that "Customer will require for the operation of the Site ..." as opposed to Section 4.2 "Developer Software" that was "created or licensed by Developer" and which may be included in the Site subject to a license to Customer. To clarify this distinction, I recommend that the first sentence of Section 2.4 be modified to read: "Any third party software that Customer will require for the operation of the Site, but not that which may be included in the Site pursuant to Section 4.2 below, is set forth on Exhibit A or the applicable Attachment."

Section 3.2 Delivery and Acceptance.

The last sentence states that Customer shall have the right to immediately terminate this development agreement after the Developer has had two opportunities to correct any identified deficiencies, "... and Developer shall immediately reimburse Customer for any amounts paid hereunder." If, for example, the Initial Services were completed and there was a defect in some part of the Site constructed under the Additional Services that could not be corrected by the Developer after two opportunities, then does this clause mean that the Developer has to reimburse Customer for all amounts paid under the entire Agreement? I would modify the last part of this sentence to read: "... and Developer shall immediately reimburse Customer for any amounts paid for that portion of the Deliverables that are affected by such uncorrected deficiencies as determined in Customer's sole but reasonable discretion."

Section 3.3 Transfer of Site.

As noted in the bolded comment, the issue of whether the Developer will be providing Hosting Services needs to be addressed. Once resolved, the language "... in conformance with the delivery schedule on Exhibit A" should agree with either the delivery schedule on Exhibit A or development milestones on Exhibit B.

Section 4.1 Customer Materials.

The first sentence of Section 4.1 seems confusing. For example, it is not clear to me whether "Customer Content" refers to materials provided by the Customer or the intellectual property rights therein. I would rewrite the first sentence as follows: "Except as provided in Sections 4.2 and 4.3 below, all Deliverables, source code for the Deliverables, and other materials developed or prepared for Customer by Developer hereunder, and all Specifications, documents, words, symbols, names, logos, characters, literary content, and other materials provided by Customer to Developer, and all inventions, patents, copyrights, trademarks, trade secrets, and other proprietary rights in all of the foregoing, including but not limited to the resulting "look and feel" of the Site (collectively, the "Customer Materials"), are the property of Customer."

Although the IP assignment clause in Section 4.1 appears to address the issues, I think it could be clarified by using the previous definitions as follows: "Any and all Customer Materials that are a copyrightable work authored by Developer shall be deemed to be a "work made for hire" to the extent permissible under the U.S. Copyright laws. To the extent that any such copyrightable work may not be considered a "work made for hire" under the U.S. Copyright



Lorraine Christine Hoffman, Esq.
Assistant Staff Counsel
The Florida Bar
File No. 2003-51, 109(15C)

laws, and further with respect to all other Customer Materials, Developer agrees to and hereby does irrevocably assign, convey, and otherwise transfer to Customer, and its respective successors and assigns, all of Developers' right, title, and interest worldwide in and to the Customer Materials, including all inventions, patents, copyrights, trade secrets, trademarks, and other proprietary rights and all contract and licensing rights therein, and all claims and causes of action of any kind with respect to any of the foregoing, whether now known or hereafter to become known. ..."

The moral rights language should be clarified by modifying it to read: "... includes all rights of attribution, integrity, disclosure, and withdrawal and all rights under 17 U.S.C. ' 106A and any other rights ..."

Section 4.2 Retained Rights.

In Subsection 4.2(a), it states that the Site is to be "delivered" to Customer by Developer. I thought it was the Deliverables that will be delivered, while the Site may be "transferred" pursuant to Section 3.3. Therefore, I would revise the beginning of this Section to read: "The parties acknowledge that the Deliverables will be a compilation of various components, ..."

In Subsection 4.2(b), the license to Customer for the Developer Software should further include a license to any patent rights that the Developer may have in the Developer Software. Therefore, I would modify this license clause to read:

Developer hereby grants to Customer a royalty-free, worldwide, perpetual, irrevocable, non-exclusive right and license, with full right to sublicense, to make, have made, use, offer for sale, sell, import, reproduce, distribute, modify, publicly perform, and publicly display the Developer Software on the Site or on any Web site operated by or for Customer.

Section 4.3 Joint Ownership of Java Applet.

In general, I believe that joint ownership of intellectual property rights should be avoided, as it usually creates more problems that it solves. Furthermore, essentially the same result can often be achieved without joint ownership.

In my opinion, the Java Applet should not be jointly owned. However, I recognize that this was the understanding between the parties at the time of its development. Nevertheless, I think that the issue of joint ownership should be revisited.

Here are just some of problems with joint ownership of the Java Applets under the language of Section 4.3.

First, I would not want to state that Developer "created" something that "allows for" the zooming and panning of JPEG images, which is the subject of some of Iviewit's patent applications. I would be concerned that this could be misinterpreted to mean that Developer could possibly be the joint owner of the inventions already on file in the Patent Office, which is not the case.

Second, joint ownership of any patent rights in the Java Applets mean that both parties have the right to use the technology, and that each party has a non-exclusive right to license third parties to use the technology without any accounting to the other joint owner. Conversely, joint owners of copyrights have a duty of accounting to the other joint owner. If there are both inventions and copyrights in the Java Applets, it may prove very difficult to define those



Lorraine Christine Hoffman, Esq.
Assistant Staff Counsel
The Florida Bar
File No. 2003-51, 109(15C)

profits that are subject to the accounting only under copyright law. Furthermore, if only copyrights exist in the Java Applets, the percentage or dollar amount this duty of accounting should be set forth in this section.

Third, although it may be possible to jointly own trademarks, trade names, and logos, it is highly unusual and very risky. The issues of quality control, trademark abandonment, duty of accounting, and sublicensing rights come to mind when discussing joint ownership of trademarks. None of those issues are addressed here, and it would probably require a separate agreement to do so.

Fourth, the issue of confidentiality may cause some problems. Since this language states that the Java Applet was created by Developer specifically for use in connection with its services provided under this Agreement, it qualifies as Confidential Information under the definition of Section 5.1 of the Agreement. However, Section 5.2 prevents the Developer from using the Java Applet elsewhere and from disclosing it to any third party. Nevertheless, the exclusions under Section 5.3 may give the Developer an argument that the Java Applet does not qualify as Confidential Information.

Fifth, if either of the two companies is ever sold, the entire Java Applet cannot be sold with either of the companies -- only that company's one-half ownership interest -- which can create additional legal problems and costs down the road.

As you can now appreciate, there are several problems with this Section 4.3. As I see it, we have three choices regarding ownership of the Java Applet: (1) Developer assigns all rights in the Java Applet to Customer, and Customer pays Developer for it and gives Developer a non-exclusive license to use it; (2) Developer maintains ownership of the Java Applet, and gives Customer a non-exclusive license to use it; or (3) joint ownership remains, so long as all of the above-mentioned problems are resolved and the terms and conditions of the joint ownership are specifically set forth in a separate agreement. Of course, this is a business decision. In making this decision, I would pose a few questions: Does Developer need to own the Java Applet, or will a non-exclusive license suffice? Why does Customer need to have ownership rights, or will a license meet those needs? What is the probability that the Java Applet will incorporate each of the various types of intellectual property (such as patents, trademarks, and/or trade secrets -- it will obviously have copyrights)? How will joint ownership of the Java Applet affect Iviewit's patent portfolio? These questions should be answered before any of the ownership choices are made. I would recommend, however, that if the Java Applet could possibly include inventions, or if it is, by itself, valuable on the open market, then Iviewit should seek to obtain exclusive ownership in order to maintain control of the intellectual property and/or the accounting (if any) of profits.

Without knowing the answers to these questions, and at the risk of contradicting what may have been previously agreed upon, I suggest that Section 4.3 be modified to read as follows:

4.3 Ownership of Java Applet. The parties acknowledge that Developer developed, on behalf of customer, the Java computer program task-specific application "applet" that facilitates zooming and panning of JPEG images (the "Java Applet"). The parties further acknowledge that the Java Applet is part of the Deliverables hereunder and does not include Developer Software. Customer shall reimburse Developer for the cost of developing the Java Applet in the amount set forth on Exhibit D hereto. The Java Applet is the exclusive property of Customer, as it is part of the Customer Materials set forth in Section 4.1 above."



Lorraine Christine Hoffman, Esq.
Assistant Staff Counsel
The Florida Bar
File No. 2003-51, 109(15C)

The issue of a non-exclusive license back to Developer for the Java Applet may still need to be addressed, with appropriate confidentiality restrictions.

Section 4.4 Domain Name.

Is it possible that the Site could have more than one URL or domain name? If so, this Section should be modified to refer to all such URLs and domain names.

Section 5.1 Confidential Information.

This definition of Confidential Information defines all the Deliverables as being confidential, even though they will be posted to a public Web site. As such, the Developer would be in breach of this confidentiality clause when it posts the information. Furthermore, it is not clear which information the clause "which are supplied by Customer to Developer" is referring to as being Confidential Information.

I would suggest that Section 5.1 be rewritten in two parts as follows:

5.1(a) An "Affiliate" shall mean any company or entity that controls, is controlled by, or is under common control with, Customer at the time in question, and specifically includes Iviewit Holdings, Inc., Iviewit Technologies, Inc., and Iviewit LLC.

5.1(b) "Confidential Information" shall mean all information and material: (a) that gives Customer or its Affiliates some competitive business advantage or the opportunity of obtaining such advantage or the disclosure of which could be detrimental to the interests of Customer or its Affiliates; or (b) that is either (i) marked "Confidential", "Restricted", or "Proprietary" or other similar marking, or (ii) known by the Developer to be considered confidential or proprietary to Customer or its Affiliates, or (iii) from all the relevant circumstances, should reasonably be assumed to be confidential or proprietary to Customer or its Affiliates. Confidential Information includes, but is not limited to, information concerning the business, customers, markets, products, technology, operations, financial structure, and assets of Customer and/or its Affiliates, and specifically includes such items as customer and vendor lists, employee lists, financial and business data, technical, engineering, and research and development information, market research and analysis data, inventions, trade secrets, and know-how.

Section 5.2 Restrictions on Use.

This Section prevents Developer (unless authorized in writing each time) from copying the Confidential Information (which necessarily will occur for them to perform their duties) and from delivering the Confidential Information to any third party (which will probably occur each time the Deliverables are transferred to the Host Service Provider). It is also somewhat inconsistent in its terminology. I would suggest that Section 5.2 be rewritten as follows:

5.2 Restrictions on Disclosure and Use. Developer acknowledges that in order to perform the Services hereunder, it shall be necessary for Customer to disclose to Developer certain Confidential Information. Developer agrees that, unless it has obtained express prior written consent from a duly authorized



Lorraine Christine Hoffman, Esq.
Assistant Staff Counsel
The Florida Bar
File No. 2003-51, 109(15C)

representative of Customer to do otherwise, it shall: (i) treat as confidential and protect the secrecy of any Confidential Information in Developer's possession or control; (ii) not disclose, publish, or otherwise make the existence, source, content, or substance of any Confidential Information available or known to the public or to any third party; and (iii) not use any Confidential Information for the benefit of any person or organization, including Developer, except as and to the extent necessary for the purpose of performance under this Agreement.

Section 5.3 Limitations.

One of the standard exceptions to the definition of Confidential Information is missing ("already known to Developer"), and several of the other exceptions should be modified. Therefore, I would suggest that the entire Section be revised as follows:

5.3 Exceptions. Customer agrees that the obligations of confidentiality under this Agreement shall not apply to any portion of the Confidential Information that Developer can show by substantial documentary evidence: (a) was in Developer's possession or previously known to Developer, without an obligation to keep it confidential, before such information was disclosed to Developer by Customer or developed for Customer by Developer; or (b) is or becomes public knowledge through a source other than Developer and through no fault of Developer; or (c) is or becomes lawfully available to Developer from a source other than Customer and was not derived from the Confidential Information; or (d) is independently developed by employees or agents of Developer that did not have access to any Confidential Information; or (e) is required to be produced under a court or governmental order, in which event Developer shall provide reasonable prior notification to Customer so that Customer may take steps necessary to protect its Confidential Information.

Section 5.4 Return of Customer Materials.

This language needs to be modified to include return of all Confidential Information: "Upon Customer's acceptance of the final Deliverables, or upon Customer's earlier request, Developer shall provide Customer with all originals and copies of all Confidential Information in tangible form, Customer Materials, and ..."

Section 6 Non-Competition.

The bolded note asks the question whether the company wants a non-compete provision. I would recommend that such a provision be included in this agreement. However, I would suggest that Section 6 be modified such that it is more likely to be enforceable, as many non-competition causes are not upheld in court. I would also suggest that this Section 6 be moved to become a subsection of Section 7. (If not, Section 6 is the only Section having only one subsection.)

I would suggest making the following modifications: The period of time should be relatively short, i.e., perhaps two or three years. The phrase "perform services" in part (i) might be changed to "perform design or development services" for clarity. The statement that "... any of those entities named by Customer as Customer's direct competitors ..." might be clarified by stating "... any person or entity that is in the same business as Customer and that could



Lorraine Christine Hoffman, Esq.
Assistant Staff Counsel
The Florida Bar
File No. 2003-51, 109(15C)

reasonably be considered a direct competitor of Customer, particularly if such person or entity performs digital imaging and/or streaming video and/or video conferencing services for third parties ..." (This would also relieve you of the burden of naming your direct competitors, and constantly updating the list.) The two remaining clauses of this Section may also need some additional modifications.

Section 7.1 Developer Warranty.

As written, this Developer warranty apparently obligates the Developer to maintain the Site forever at Developer's own expense. I doubt that this will be acceptable to the Developer. This warranty also appears to state that the Developer has to "fully cooperate" in providing the Services "at no cost" to Customer, which should be clarified. Furthermore, the warranty against infringement/misappropriation of third party IP rights, as written, would make the Developer fully liable whether or not the Developer was aware of such infringement or misappropriation, and even include liability for Customer Content posted to the Site. I think this entire section needs to be modified.

In order to use the following modifications, Section 7.1 needs to start out as: "Developer represents and warrants that: ...".

Programming bugs should be warranted: "... (1) the Deliverables and the Site will be free from reproducible programming errors and free of defects ..."

The Specification should be the basis of the performance warranty: "... (2) the Deliverables and the Site will function and conform in all material respects to the Specifications and other ..."

Programming originality should also be warranted: "... (3) all works of authorship in the Deliverables are original and have not been copied or derived from a third party's work, except to the extent Developer's Software is included in the Deliverables as authorized under this Agreement;"

The warranty against infringement/misappropriation in clause (4) of Section 7.1 can remain if the remedy is addressed (see below): "... the Deliverables and the Site shall not infringe ... ;"

Only full-time employees of Developer should work on the Deliverables to ensure proper transfer of IP ownership: "... (5) unless Developer has obtained express prior written consent from a duly authorized representative of Customer to do otherwise, only those persons that are full-time employees of Developer acting within the scope of their employment shall perform Services for Customer under this Agreement, such that all copyrightable subject matter made by those persons will be covered by the definition of a "work made for hire" under the U.S. Copyright laws and Developer will be regarded as the author and owner of all copyrights in any such works;"

Ownership of employee work product and written employee confidentiality obligations should be warranted: "... (6) unless Developer has obtained express prior written consent from a duly authorized representative of Customer to do otherwise, only those persons that have (i) executed an intellectual property assignment agreement in favor of Developer, and (ii) have executed a confidentiality agreement with Developer consistent with the obligations of Developer under this Agreement, shall perform Services for Customer;"

Title should be warranted: "... (7) Developer either owns or has the right to license the Deliverables provided to Customer under this Agreement, including any Developer Software used in the Deliverables, and Developer shall not include or use any materials or other



Lorraine Christine Hoffman, Esq.
Assistant Staff Counsel
The Florida Bar
File No. 2003-51, 109(15C)

technology in the Deliverables that would conflict with Developer's obligations under this Agreement;"

Third party confidentially should be warranted: "... (8) Developer will not disclose to Customer, nor make use of during the Services provided hereunder, any trade secrets or other proprietary information of any third party, unless Developer may do so without Developer or Customer incurring any obligation, past or future, to such third party for such work or any future application thereof."

There should be a warranty against disablement: "... (9) no portion of the Deliverables contains or will contain any protection feature designed to prevent its use or to provide unauthorized use, unless otherwise expressly authorized in writing by Customer, including, without limitation, any computer virus, worm, software lock, drop-dead device, Trojan-horse routine, trap door, time bomb, or any other codes or instructions that may be used to access, modify, delete, damage, or disable the Deliverables or the Site or Customer's or its client's use thereof."

There should be a warranty against conflicts of interest; "... (10) Developer has no present or future activities or obligations with any third party that will in any way conflict with or limit or restrict Developer's ability to perform the Services for Customer hereunder. In case of doubt, prior to commencing such activities or obligations, Developer will review the area of possible conflict with appropriate representatives of Customer."

The second full sentence of Section 7.1 states that the Developer agrees to correct [fix] any failure of any Deliverables to meet the warranty. However, sometimes it is impossible to "fix" something to keep it from infringing a patent. Therefore, I would add a new Subsection 7.5 (see below) and modify this sentence to begin with: "Unless otherwise set forth in Section 7.5 below, Developer agrees to correct ..."

Section 7.2 Customer Warranty.

It is not clear to me what was meant by the language "Customer shall be responsible for Customer Content ...", and I'm not sure whether this language would qualify as a warranty. Section 7.2 also does not define what kind of taxes are the Customer's responsibility. Nevertheless, I see no need for any such Customer warranty section to be included in this agreement, particularly at this stage of the agreement negotiation. (If this Section is kept in, the definition of Customer Content has to be reinstated in Section 4.1.)

Section 7.3 Developer's Indemnity.

This indemnity language appears to cover an unlimited amount of direct damages for breach or infringement -- which could reach into the millions of dollars if the Web site was shut down and iViewit could not continue to do business over the Site due to such breach or infringement. If this is what was it was intended to cover, there should be a requirement in this agreement that the Developer has a specified amount of commercial liability insurance for covering such an indemnification obligation, perhaps naming Customer as a preferred beneficiary under the policy. Furthermore, a warranty/indemnity clause for infringement usually addresses what will happen in the event of an injunction, which is a normal remedy for infringement and misappropriation. I think Section 7.3 should be revised accordingly.

Section 7.4 Obligations Relating to Developer Indemnity.

Although it is commonly done, providing the Developer with the sole right to defend and settle indemnification claims could be a problem if it includes a right to settle an action for an injunction, either temporary or permanent, that could shut down the Site and prevent



Lorraine Christine Hoffman, Esq.
Assistant Staff Counsel
The Florida Bar
File No. 2003-51, 109(15C)

Customer from continuing its business. I would at least modify this sentence to read: "... solely defend and settle any claim for monetary damages, ..." and then see if they object. Moreover, the phrase "with the reasonable assistance of Customer" should also be qualified by adding: "... and at Developer's sole expense."

New Section 7.5 Intellectual Property Infringement.

I would add the following as a new Subsection 7.5:

7.5 Infringement Procedures. In the event that the use of the Deliverables or the Site infringes or misappropriates any patent, copyright, trademark, trade secret, or other intellectual or industrial property right of any third party, and, as a result therefrom, an action is brought seeking an injunction against Customer to stop using the Deliverables or the Site, either wholly or in part, then Developer shall, at its option and its expense, either: (a) obtain for Customer the right to continue using the Deliverables and the Site; or (b) modify the Deliverables and/or the Site in such a way that they become non-infringing, as long as the modified Deliverables and/or the Site are of comparable quality and functionality.

Section 7.7 Disclaimer.

If Section 7.2 "Customer Warranty" is removed (per my suggestion above), then Section 7.7 (and perhaps Section 7.8) should be revised to refer only to Developer and not to both parties.

More importantly, if Developer had anything to do with the preparation of the Specification (which is the basis of the performance warranty) such that Customer is relying on Developer's skill or judgment in selecting, defining, or designing the Deliverables or the hosting equipment or personnel, then I would not let the Developer disclaim the implied warranties of merchantability and fitness of a particular purpose. Perhaps the entire Section 7.7 should be omitted until the Developer requests that there be some such disclaimer.

New Section 7.9

I would add the following new Section here:

7.9 No Liability for Customer. Customer shall have no liability to Developer and Developer shall indemnify and hold Customer harmless from any and all claims for property loss and injury (including death) to Developer and its employees and agents that may result in connection with the performance of Services hereunder, provided that such injuries are not a result of the sole intentional or negligent acts of Customer or its employees.

Section 8 Termination.

I would suggest that this Section 8 be re-titled "Term and Termination" and that a new Section 8.1 be added as follows:

8.1 Term. This Agreement shall commence on the Effective Date and shall continue for a minimum period of one (1) year, and shall continue thereafter for so long as the Customer seeks



Lorraine Christine Hoffman, Esq.
Assistant Staff Counsel
The Florida Bar
File No. 2003-51, 109(15C)

and obtains Services from Developer, unless terminated earlier
in accordance with this Agreement.

Section 8.1 (8.2) Termination for Convenience.

I agree that only Customer should be able to terminate for convenience in a very short time frame. I question whether twenty days is appropriate if Developer can continue working for those twenty days and Customer will be obligated to pay for it. I also think that the Developer should be given some way out of the agreement other than bankruptcy. Perhaps this Section should be modified to allow Customer to terminate for convenience effective immediately, and Developer to terminate for convenience upon ninety (90) days prior notice.

Section 8.2 (8.3) Termination for Non-Performance or Delay.

If Customer can terminate immediately, there is no need for this Section. If not, the time period should not be greater than the twenty days (or whatever) needed to terminate for convenience. Note that there is no "cure period" other than that in Section 3.2.

Section 8.4 (8.5) Effect of Termination.

Note that the Java Applet is specifically mentioned here.

Section 9.2 Assignment.

I would make this agreement freely assignable by Customer to one of its affiliates as follows: "... of the other party; provided, however, that Customer may, upon notice to Developer, assign its rights under this Agreement to any Affiliate of Customer or to the acquirer of substantially all of its business. ..."

Section 9.6 Publicity.

Since policing of Iviewit trademarks and other statements is a burden to Iviewit, I normally don't advise that you agree up front to consent to granting publicity rights to others. Therefore, I would omit the language "... which consent shall not be unreasonably withheld."

I hope that these comments prove useful. I would be happy to discuss any of the above with either you or the Proskauer attorney, or modify and finalize this agreement, upon your request.

Very truly yours,

Douglas A. Boehm

Attachment

*Douglas A. Boehm
Foley & Lardner
777 East Wisconsin Avenue
Milwaukee, Wisconsin 53202
Tel: (414)297-5718*



Lorraine Christine Hoffman, Esq.
Assistant Staff Counsel
The Florida Bar
File No. 2003-51, 109(15C)

Fax: (414)297-4900
Email: daboehm@foleylaw.com

NOTE: The information transmitted in and/or attached to this message is intended only for the person or entity to which it is addressed and may contain confidential and/or privileged material. Any review, retransmission, dissemination, or other use of, or taking any action in reliance upon, this information by persons or entities other than the intended recipient is prohibited. If you received this information in error, please contact the sender and delete the material from any computer.

Outgoing mail is certified Virus Free.
Checked by AVG anti-virus system (<http://www.grisoft.com>).
Version: 6.0.384 / Virus Database: 216 - Release Date: 8/21/2002

Needless to say, this agreement in NO form was ever signed as it appeared that Mr. Wheeler was working on behalf of RYJO and the following Cease and Desist letter was sent to RYJO regarding their claims that they had invented the Iviewit image applet. RYJO and Ryan Huiseman would later take calls from Iviewit investors and tell them that they owned the Iviewit technologies, feeling that all copies of the RYJO NDA had been destroyed by Wheeler and Utley.



Lorraine Christine Hoffman, Esq.
 Assistant Staff Counsel
 The Florida Bar
 File No. 2003-51, 109(15C)



www.iviewit.com

2255 Glades Road
 One Boca Place - Suite 337V
 Boca Raton, FL 33431
 Voice: 561.999.8899
 Fax: 561.999.8810
 Toll: 877.484.8444

September 5, 2000

Mr. Ryan J. Huisman
 Ryjo, Inc.
 12135 Walden Woods Drive
 Orlando, Florida 32826

EV
 III
 BIN
 III

Via Mail and email

Dear Ryan:

The purpose of this letter is to review and redefine the relationship between **iviewit** and Ryjo, Inc.

Ryjo has functioned as a sub-contractor to **iviewit** for much of the past year, and we are pleased to acknowledge that, aside from amounts presently due Ryjo, we have paid over \$85,000 to your company and its predecessor this year. While we have been generally pleased with your work, as **iviewit** expands and progresses to major financing and growth, we believe that it is important at this time to impart more definition for the future.

As to general ground rules to the relationship, we need to enumerate the following:

1. All work done in the past, currently or in the future executed at the request of **iviewit** is the exclusive property of this Company.
2. All project work contemplated to last more than one week in duration must be approved in advance, in writing, by Mike Reale with a written timeline and a budget figure presented by Ryjo, including a firm "not-to-exceed" amount.
3. With the exception of "executables" coming from our lab and Eliot Bernstein's requests (who always copies Mike Reale), all work to be done for **iviewit** must be approved in writing in advance by Mike Reale. It is Ryjo's responsibility to refer any other requests for work to be done for **iviewit** back to Mike Reale for review and approval.
4. Obviously, as a result of the relationship with **iviewit**, Ryjo has gained a previously unknown body of knowledge (including **iviewit** trade secrets) involving video streaming and digital imaging. As a result, in the event Ryjo conceives or develops additional products or applications involving such technologies, **iviewit** is to have a First Right of Refusal as to such development work or completed product.



Lorraine Christine Hoffman, Esq.
Assistant Staff Counsel
The Florida Bar
File No. 2003-51, 109(15C)

Separately, it is important to remind you that Ryjo is subject to a Non Disclosure Agreement with **iviewit** signed and returned on September 9, 1999. As a result, it is essential under that agreement that any requests or inquiries to Ryjo as to the development work done on behalf of **iviewit**, or as to the relationship in general, require that you present all such requests to **iviewit** before responding. In this regard, we are most concerned that on more than one occasion you personally have stated that Ryjo owns certain technology that is essential to **iviewit**'s business. Most recently, it is reported to us that you stated that Ryjo owns all rights to the applet that enables **iviewit**'s digital imaging zoom and pan capabilities and that **iviewit** consequently has nothing unique in this category. Obviously, this is the furthest thing from the truth, and we must demand that you cease and desist from any and all such statements, not only from the standpoint of the future of our relationship, but also as they do real harm and damage to **iviewit** as already may have occurred inasmuch as these statements were made to a substantial prospective investor in **iviewit**. As a result, we are also requesting your separate letter to us confirming **iviewit**'s proprietary rights and ownership in anything that Ryjo has developed for us. As to the applet, in particular, please confirm as well that this is a *single use (or application) applet* which **iviewit** not only has rights to, but which **iviewit** could otherwise develop on its own.

iviewit currently owes Ryjo certain amounts, and we plan to make partial payments in imminently and again in late September. Based on a next round of contemplated financing, we expect to be in a position to clear all amounts in the not too distant future. However, we also have discussed the possibility of Ryjo converting a portion of your receivable to **iviewit** equity (shares) in order for you to enjoy the possibility of upside potential. If you are still open to this, we must discuss and agree to it quite soon.

We hope we can continue a long and mutually successful relationship for the long term, and we expect that the current bumps in the road will not prove to be serious obstacles.

Very truly yours,

Michale Reale
Vice President Operations

Raymond T. Hersh
Chief Financial Officer

Cc Brian Utley
Eliot Bernstein





Lorraine Christine Hoffman, Esq.
Assistant Staff Counsel
The Florida Bar
File No. 2003-51, 109(15C)

What is important to note about this attempt to walk the image applet out of the Company by Mr. Wheeler and his friends is that the applet, the algorithms that compose it, are the core of the Iviewit concept represented mathematically. This is what would land on a chip, in software and hardware to control the zoom effect created by Iviewit. Once this attempt was foiled, the next attempt came when Mr. Utley tried to write the same code into his home address with Foley and Lardner. Mr. Wheeler since learning of the applications of the zoom and pan and video inventions has consistently devised scheme after scheme to try and lift this technology from the rightful inventors and the Company with his friends, some of them with highly questionable backgrounds in patent malfeasances.

XV. See Brian Utley inventions going to his home, as sole inventor, no assignment to Company.

After the RYJO instance was foiled and the applet remained Iviewit's we see Mr. Wheeler, Mr. Dick and Mr. Utley make yet another attempt at stealing the code. This time they revert to plain old theft as Foley and Lardner knowingly aids and abets Mr. Utley in walking the code to Mr. Utley's home. Foley and Lardner did such action with full knowledge of the true inventors and that Iviewit had rights to these inventions.

We submit:



Lorraine Christine Hoffman, Esq.
Assistant Staff Counsel
The Florida Bar
File No. 2003-51, 109(15C)

Atty. Dis. No. 57103/123

U.S. PROVISIONAL PATENT APPLICATION

for

**ZOOM AND PAN IMAGING
DESIGN TOOL**

Inventors:

Brian G. Utley
1930 SW 8th Street
Boca Raton, FLORIDA 33486
Citizenship: U.S.

FOLEY & LARDNER
Attorneys at Law
777 E. Wisconsin Avenue
Milwaukee, Wisconsin 53202
(414) 271-2400

We submit as further evidence:



Lorraine Christine Hoffman, Esq.
 Assistant Staff Counsel
 The Florida Bar
 File No. 2003-51, 109(15C)

VIEWIT.COM PATENT STATUS REPORT

05707

TITLE	MATTER	INVENTOR/ PATENTEE	COUNTRY	SERIAL NO./ PATENT NO.	FILED/ISSUE DATE	ASSIGNEE
<u>Zoom and Pan Imaging Using a Digital Camera</u>	P020 (fka 122)	<u>Brian Utley</u>	United States	Serial No. 60/223,344	Filed 09/18/00	<u>Not assigned.</u>
<u>Zoom and Pan Imaging Design Tool</u>	P021 (fka 123)	<u>Brian Utley</u>	United States	Serial No. 60/233,341	Filed 09/18/00	<u>Not assigned.</u>

Blakely, Sokoloff, Taylor & Zafman

3

The second patent Utley has in his own name with no assignment to the Company is **ZOOM & PAN IMAGING USING A DIGITAL CAMERA**. This summary page was provided to Ivieit's investor Crossbow Ventures by Blakely Sokoloff Zafman and Taylor, and Crossbow then pulled funding on the Company in what appeared to be related to the discovery of such information, investigation pending. As you can see Utley is sole inventor of ideas that were created prior to his employment at **ivieit**.

Please refer to the footnote in the following document from Blakely Sokoloff Zafman & Taylor letter after finding such stolen patents and having to try and re-assign them to the Company.



Lorraine Christine Hoffman, Esq.
 Assistant Staff Counsel
 The Florida Bar
 File No. 2003-51, 109(15C)

BLAKELY SOKOLOFF TAYLOR & ZAFMAN LLP

A LIMITED LIABILITY PARTNERSHIP
 INCLUDING LAW CORPORATIONS

TELEPHONE (310) 207-3000

FACSIMILE (310) 820-5988
 (310) 820-5270

ESTZ_MAIL@BSTZ.COM
 WWW.BSTZ.COM

INTELLECTUAL PROPERTY LAW

12400 WILSHIRE BOULEVARD
 SEVENTH FLOOR
 LOS ANGELES, CA 90025-1026

OTHER OFFICES

AUSTIN, TX
 SUNNYVALE, CA
 COSTA MESA, CA
 SAN DIEGO / LA JOLLA, CA
 PORTLAND / LAKE OSWEGO, OR
 SEATTLE / KIRKLAND, WA
 DENVER / ENGLEWOOD, CO

August 4, 2001

**Confirmation
 Copy**

**CONFIDENTIAL COMMUNICATION
 ATTORNEY-CLIENT PRIVILEGED**

VIA E-MAIL
 (And Confirmation By Mail)

Eliot Bernstein
 IVIEWIT.COM, INC.
 505 North Brand Boulevard, Suite 1420
 Glendale, California 91203

Re: Powers of Attorney for Six PCT Applications:

Apparatus and Method for Producing Enhanced Digital Images Serial No. PCT/US00/07772 Our File No. 005707.P009PCT Foley's Reference No. 110	System and Method for Playing a Digital Video File Serial No. PCT/US00/15406 Our File No. 005707.P012PCT Foley's Reference No. 113
System and Method for Streaming an Enhanced Digital Video File Serial No. PCT/US00/15408 Our File No. 005707.P010PCT Foley's Reference No. 111	System and Method for Video Playback Over a Network Serial No. PCT/US00/15602 Our File No. 005707.P016PCT Foley's Reference No. 118
System and Method for Providing an Enhanced Digital Video File Serial No. PCT/US00/15405 Our File No. 005707.P011PCT Foley's Reference No. 112	System and Method for Providing an Enhanced Digital Image File Serial No. PCT/US00/21211 Our File No. 005707.P018PCT Foley's Reference No. 120

Dear Eliot:

Being e-mailed (and enclosed herewith) are six (6) Powers of Attorney for the subject PCT Patent Applications, one Power for each inventor named in any one or more of the PCT patent applications, and one Power for the corporation, Iviewit Holdings, Inc. Three of the Powers require your signature, as follows: (i) one by you in your individual capacity; (ii) a second by you in your capacity as designee of the corporation to sign on behalf of Brian Utley (we hope the PCT Office will recognize Utley's having granted a Power of Attorney to his corporate employer); and (iii) a third by you for the corporation in your capacity as its Secretary. Kindly sign where your



Lorraine Christine Hoffman, Esq.
 Assistant Staff Counsel
 The Florida Bar
 File No. 2003-51, 109(15C)

BLAKELY SOKOLOFF TAYLOR & ZAFMAN LLP

A LIMITED LIABILITY PARTNERSHIP
 INCLUDING LAW CORPORATIONS

Eliot Bernstein
 IVIEWIT.COM, INC.
 August 4, 2001
 Page 2 of 2

signature is indicated on the three Powers of Attorney and return the original executed Powers to our office via mail (we need to have each Power with an original signature). Also fax each Power to us at (310) 820-5988, to expedite the process.

As we discussed, we request that you also forward each of the three remaining Powers to Jude R. Rosario, Jeffrey S. Friedstein and Zakirul A. Shirajee, respectively, for their signatures. Kindly instruct each of them to execute the Powers and to return the originals to our office by mail. In order to expedite the matter, request each of them to fax a copy to us, if possible.

If you have any questions, please feel free to contact my Assistant, Jan Gass. We appreciate your attention to getting the subject Powers executed and returned to us. We will then attend to their filing with the PCT Office.

Best personal regards,

BLAKELY, SOKOLOFF, TAYLOR & ZAFMAN, LLP

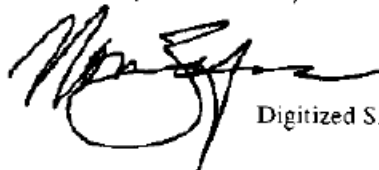

Digitized Signature

Norman Zafman

NZ/jg
 Enclosures

cc: Ross Miller (w/Enclosures via E-Mail) ✓

P.S. to Ross Miller:

→ Ross, please attend to getting a Board Resolution appointing Eliot as the corporation's designee for signing the subject Power on behalf of Brian Utley. We talked about this in the context of giving Eliot comfort; however, the PCT Office may well request such a Resolution (in addition to a copy of Utley's Employment Agreement, which we already have).

Finally we submit several other technologies that Mr. Utley was contemplating as claiming as his own, all invented by Iviewit prior to his joining the Company. He has his secretary, Martha Mantecon notarize such forms, Martha he knew from his prior



Lorraine Christine Hoffman, Esq.
Assistant Staff Counsel
The Florida Bar
File No. 2003-51, 109(15C)

employment at Diamond Turf Lawnmower who was also fired by Mr. Friedkin with Mr. Utley.



Lorraine Christine Hoffman, Esq.
Assistant Staff Counsel
The Florida Bar
File No. 2003-51, 109(15C)

Invention of Controllable Image Presentation with Audio and/or text Accompaniment

Object: To control a presentation image by a program within the computer or remotely over a network such that when the program is initiated it will control the presentation image by selecting panoramic and/or zoom parameters in order to focus the attention of the viewer on particular elements of the image. The program may also control an audio track or text box to explain to the viewer details of the image.

The program may be initiated by the viewer or automatically upon selection of the image.

Maurea Marteen
Witness
Date: 3/8/00

[Signature]
Inventor
Date: 3/8/2000

EV 41
41.1
B 1



Lorraine Christine Hoffman, Esq.
Assistant Staff Counsel
The Florida Bar
File No. 2003-51, 109(15C)

**Invention of Image Overlay Over the Web
To Facilitate Expanded Presentation Facilities**

Object: To create an image overlay for the purpose of further defining the image, superimposing graphics and superimposing text. The overlay is controlled by software on the computer hosting the display device or over a network. The software may be initiated by the operator/viewer or automatically upon selection of the first level image.

This invention also contemplates multiple layers of overlay for complex presentation purposes.

Manda Masterson
Witness
Date: 3/8/00

[Signature]
Inventor
Date: 3/8/2000

EV 41
41.2
BIN 1



Lorraine Christine Hoffman, Esq.
Assistant Staff Counsel
The Florida Bar
File No. 2003-51, 109(15C)

The company refers the Florida Bar to read Mr. Utley's deposition that is in direct opposition to the facts presented throughout this rebuttal. It will be noted that Mr. Utley claims that he has no inventions in his sole name. Utley claims he assigned all patents to Iviewit, that he was unaware of any problems with the patents, that he never used Rubenstein as an advisor and a host of other outright lies.

XVI. Wheeler referred Investor Crossbow Ventures, takes a security interest in the Iviewit patents claiming it was to protect shareholders from threatened litigation by Proskauer Rose LLP and a threatened Involuntary Bankruptcy action threatened by Utley, Hersh, Reale and RYJO. Crossbow later tries to assign their interests in the patents claiming that they own them through the default on their secured notes.

It will serve the bar to note, that at the time the secured assignments were proposed the litigation from Proskauer was threatened which later materialized, and the threatened Involuntary also later materialized. We request the Florida Bar to contact Ms. Caroline Prochotska Rogers, Esq. who has taped Board calls where representatives of Crossbow still on the Board solicit the secured notes as a method of protection. In fact, when asked about the risk of them calling such notes to gain for themselves, they state to the Board that it is not a "Machiavellian plot" to steal the technologies. Several weeks after securing such notes with Management they picked to replace Mr. Utley, the Board member H. Hickman Powell whom had sold the notes to the Board resigned from the Board. Crossbow then continued to fund what was supposed to be a 1.5M dollar loan, on a month to month basis for approximately six months and then short of the agreed upon amount and claiming that the malfeasances were the basis for ceasing to fund, ceased to fund the Company. This is not before Crossbow Ventures tortuously interfered with Management of the Company, the Companies clients and the Companies patent counsel. In fact, against the desire of the Company Crossbow unilaterally without consulting any management or Board members, interfaced with the Companies patent attorney's BSTZ and made decisions on which Countries the Company's patents would be filed in, causing the Company major loss of patent rights throughout the world over a 20 year lifetime.

The Company feels that whether these actions were together in collusion with Mr. Wheeler or as separate acts of malfeasance that either way, the actions were a direct result of the many malfeasances attributable to Mr. Wheeler.

We submit the following letter from Mr. David Colter who was flown to Florida by Crossbow Ventures in anticipation of talks regarding a 20M investment in the Company and instead was advised that Crossbow intended to Bankrupt the Company and wash away the shareholders, although at the time Crossbow did not have a controlling interest. Colter was dismayed that instead of a business plan to take to AOLTW that a bankruptcy



Lorraine Christine Hoffman, Esq.
Assistant Staff Counsel
The Florida Bar
File No. 2003-51, 109(15C)

was what was being proposed. This is after members of Crossbow, Hank Powell and Ravi Ugali flew out to California and met with representatives of Warner Bros. and Sony to learn that the Iviewit technologies were to be the backbone technology used for the delivery of a 5 studio movie-download project Movielink. Moreover, Aidan Foley, ex-CEO of Kodak Cinesite and a hired consultant for Crossbow, had met with several major studios and based on their usage for this project had estimated revenues to be in the millions starting immediately and in fact we had Irell and Manella drafting a pre-paid royalty agreement for such usages with both Warner Bros. and Sony. After hearing the good news, Crossbow plotted with management they had implemented to wipe out Iviewit and it's shareholders.

We submit:



Lorraine Christine Hoffman, Esq.
Assistant Staff Counsel
The Florida Bar
File No. 2003-51, 109(15C)

Eliot I. Bernstein

From: David.Colter@warnerbros.com
Sent: Thursday, October 25, 2001 10:50 AM
To: Eliot.bernstein@verizon.net
Subject: Fwd: Iviewit

In a message dated 10/25/2001 12:08:38 AM Pacific Daylight Time, David.Colter@warnerbros.com (DColter0264) writes:

Subj: **Iviewit**
Date: 10/25/2001 12:08:38 AM Pacific Daylight Time
From: David.Colter@warnerbros.com (DColter0264)
To: gt@22twain.com
Sent on: AOL 6.0 for Windows US sub 10539

Greg,

I wanted to give you an update on iviewit, since we will be missing each other until the 7th of Nov (vacation next week).

Eliot's erratic behaviour regarding the NDA was anything but erratic. I have since learned from a number of sources that Eliot believed we were part of, and supporting, a pre-packaged bankruptcy for the company that would clean out the current investors (mostly friends and family who had their investment considered as unsecured debt for tax protections I believe) and leave Crossbow, it's friends, the original patent attorneys and Aidan with majority control of the IP -- wiping out Eliot and many people I know and care about.

Aidan told Eliot that we had agreed with this plan -- hence Eliot's behaviour at that time. I have also talked with a number of people who are involved with iviewit -- Alan Epstein, Aidan, Hank, etc -- and the story seems fairly clear, and I believe that inappropriate actions have taken place -- the primary investor has been running the company, and seems to have engineered all of the investment as debt to force the BK, and gain control of the IP from it's inventor. I have learned a lot more about business this week, that I would rather not need to know.

John Calkins, Clarissa Weirick and I met with Eliot and Aidan last Friday. John was surprised at Crossbow and Aidan's actions, when all of the patent opinions look very favorable, and when we have been waiting for a business plan since February to take to Heidi Krauel at AOLTW Ventures. John wants to arrive at an investment decision in 6 weeks, and the primary task is the assessment of the patents. You are probably the best one to answer some of the questions:

- Ken Rubenstein was one of the original attorneys who looked at the patents and whose firm in FL filed the originals -- should we approach Ken for an opinion?

- Zaffman provided what seems like a very strong opinion. Would you take a look at it and provide your perspective? I can send under another cover.

- If we end up with a percentage ownership of the IP, how does that impact our ability to leverage in patent pools? Do we need to have full control.

Your input is very important.

Additionally, I know you provided Aidan a good perspective on licensing. I want to suggest that you should talk with Alan Epstein, and possibly Eliot, before dealing with him in the future. I am concerned that he has been less than honorable in his dealings with Eliot, iviewit and ourselves. I am not completely certain, but have a bad



Lorraine Christine Hoffman, Esq.
Assistant Staff Counsel
The Florida Bar
File No. 2003-51, 109(15C)

feeling based on many people's views on what is happening to iviewit. I would be very interested in your opinion on this.

Hopefully, we can talk about this when you are back... I would be happy to chat from my vacation in Orlando... Eliot is a friend and I want to explore all options to help.

Travel safe and take care.

Thanx,
David

Further Crossbow had tried to entice Mr. Colter into another Company they were looking at investing in, that had what was deemed competing technology with Iviewit a Company called Zeosync, that upon review the Company and the mathematicians supporting the technologies were called into question by the press and deemed a hoax. Mr. Colter was offended by the offer. It is the Companies belief that this Company was yet another attempt by Wheeler and his friends to transfer the company's technologies to another company, and bankrupt Iviewit. Under deposition, Mr. Wheeler and Rubenstein could not recall if they new Zeosync.

We further submit a letter from Colter pointing to the bad intent of Crossbow that he had recently learned of:



Lorraine Christine Hoffman, Esq.
Assistant Staff Counsel
The Florida Bar
File No. 2003-51, 109(15C)

-----Original Message-----

From: David.Colter@warnerbros.com [mailto:David.Colter@warnerbros.com]
Sent: Tuesday, January 15, 2002 8:05 AM
To: Eliot I. Bernstein
Subject: Fwd: iviewit -- FOR YOU ONLY!!!!!!!!!!!!

FYI -- FOR YOUR EYES ONLY

In a message dated 1/14/2002 9:51:08 PM Pacific Standard Time, David.Colter@warnerbros.com (DColter0264) writes:

Subj:iviewit
Date:1/14/2002 9:51:08 PM Pacific Standard Time
From:David.Colter@warnerbros.com (DColter0264)
To:John.calkins@warnerbros.com
CC:CHuck.dages@warnerbros.com, Alan.Bell@warnerbros.com (ABell0648)
Sent on: AOL 6.0 for Windows US sub 10551

John,

In all the review we have done with iviewit it seems to boil down to the status of the patents and their inherent value. At that point it is a risk-reward evaluation -- without awarded patents it is difficult to completely assess the value. I would suggest that we consider one other perspective...

Prior to iviewit (approx Feb 2000) the video we (WB Online) delivered on the web was QCIF (160x120) or smaller and was below full frame rate. At the time of our first meeting we also identified On2 along with iviewit as two solid players who could deliver full screen full frame rate web video. All who saw it were impressed. Greg and I visited iviewit in August and reported back that they had filed patents on scaling techniques that hinged upon a visual 'trick' which allowed the human eye to accept 320x240 video scaled to 640x480 at 30 fps as close to VHS quality. We checked with Ken Rubenstein and others who provided some solid support for iviewit, and Chris Cookson asked Greg and I to continue to work with iviewit in an R&D capacity.

In the fall of 2000 iviewit also met with a number of folks at WB Online (in September and October) and demonstrated their process and techniques to Sam Smith, Houston, Joe Annino and others. Sam contacted iviewit a number of times and requested the patents, along with specifics of the iviewit process to evaluate



Lorraine Christine Hoffman, Esq.
Assistant Staff Counsel
The Florida Bar
File No. 2003-51, 109(15C)

what they were doing. I was not part of these meetings, but was aware they had occurred, as Jack Scanlon kept me up to date.

When I sat down with Morgan and Houston in March 2001 to see what technology they were using to encode video, it was clear that they were using some of the techniques that would overlap with iviewit's filed process patents (still pending), but it is not clear that these were all learned from iviewit -- we may wish to explore this a little. This meeting was to determine what equipment we would get for our lab at 611 Brand. This same information was also provided to iviewit by Morgan as they were establishing the company as an outsourcing facility for encoding our content.

I am aware of several meetings held between iviewit and WB Online to share information of techniques and process, and was invited to a few of them.

We all signed iviewit's confidentiality agreement. So to the other perspective...

We have an opportunity to establish a license with iviewit for a modest fee at this time, and establish a MFN. In good faith we signed the confidentiality agreement, iviewit revealed their processes and techniques, and we now use those techniques in encoding. As we have discussed on a few occasions, these techniques now appear in the public domain to some extent in documentation for Real Producer, WMP Developer Guides, Media Cleaner Pro, etc, but they were not available in 2000. I would not suggest we learned the techniques completely from iviewit (I actually do not know the answer), but a modest licensing fee may be appropriate and honorable considering our good faith relationship in signing the confidentiality doc.

If we choose to pass at this time the risk is primarily from iviewit's main investor, Crossbow Ventures, gaining control of the IP and approaching WB later for a license -- I do not believe they will be as friendly considering their dealings with iviewit and it's employees since Feb of 2001. It is estimated that the patents will be completed in 8-12 months.

As you are all aware I have a personal relationship with Eliot Bernstein, the founder of iviewit, and as a result, I left the evaluations and decisions to Greg, and others, and only assisted iviewit to get to the correct people in WB and AOLTW. I wanted to add this perspective as we consider if there is an option to pursue with iviewit -- they are facing continued financial pressure right now. There are many other threads to our interaction with iviewit and I would be happy to discuss.

Thanx,
David

Next we see that as Mr. Colter is arranging for investment meetings with AOLTW investment group, Hank Powell wants to contact the AOLTW representative which puts all kinds of undue pressure on the Company as we did not have a business plan ready or management in place. The Company was very upset that the Secured investor was interfering in the Ivewit Company business and putting the Warner Bros. team in an uneasy position.



Lorraine Christine Hoffman, Esq.
Assistant Staff Counsel
The Florida Bar
File No. 2003-51, 109(15C)

Eliot I. Bernstein

Subject: FW: iviewit

-----Original Message-----

From: HeidiKrauel@aol.com [mailto:HeidiKrauel@aol.com]
Sent: Monday, June 04, 2001 3:17 PM
To: David.Colter@warnerbros.com
Subject: iviewit

In addition, I have been working with iviewit (summary in my last e-mail attachment) who have Crossbow ventures as their primary investor. The Crossbow folks brought your name up and asked if it was appropriate to contact you directly? I can provide some more detail to you.... I will attempt to call you prior to the conf call depending on my travel today, otherwise do you have some time for a quick call tomorrow?

They can definitely contact me directly. More detail or materials on iviewit would also be helpful. Thanks.

Heidi

Heidi Krauel
Associate
AOL Time Warner Ventures
22000 AOL Way
Dulles, VA 20166
Phone - 703 265 1134
Fax - 703 265 3925
Email - heidikrauel@aol.com

We submit further evidence that as a secured creditor Crossbow was dealing with management in interfering ways, here they fly ONLY Aidan Foley out and plan the bankruptcy with him.



Lorraine Christine Hoffman, Esq.
Assistant Staff Counsel
The Florida Bar
File No. 2003-51, 109(15C)

Eliot I. Bernstein

Subject: FW: CrossBow Meeting in Florida Plans

-----Original Message-----

From: maurice r. buchsbaum [mailto:buchs@bellsouth.net]
Sent: Friday, July 31, 1998 12:24 PM
To: aidan.foley@clearviewnetworks.com; eliot@iviewit.com
Subject: CrossBow Meeting in Florida Plans

Aidan: I understand from Ross Miller that you (and Eliot?) plan on meeting with the CrossBow group in Florida possibly this Thursday? If so, what are your plans in general? If not, what is the agenda for Hank Powell and Steve Warner? Maurice

Incoming mail is certified Virus Free.
Checked by AVG anti-virus system (<http://www.grisoft.com>).
Version: 6.0.474 / Virus Database: 272 - Release Date: 4/18/2003



Lorraine Christine Hoffman, Esq.
Assistant Staff Counsel
The Florida Bar
File No. 2003-51, 109(15C)

Next we find that after meeting with management Crossbow decides with no consent of the Company to try and pull the Company into a bankruptcy making unclear if management was working for Crossbow or Iviewit's interests.



Lorraine Christine Hoffman, Esq.
Assistant Staff Counsel
The Florida Bar
File No. 2003-51, 109(15C)

Eliot I. Bernstein

From: Eliot I Bernstein [res0bf4a@verizon.net]
Sent: Monday, October 22, 2001 11:50 AM
To: Simon L. Bernstein (E-mail); Jeffrey Friedstein (E-mail); Jeffrey Friedstein (E-mail 2); David J. Colter (E-mail); David J. Colter (E-mail 2); Aidan P. Foley (E-mail); Aidan P. Foley (E-mail 2)
Subject: FW: Larry

-----Original Message-----

From: Bill Kasser [mailto:bill@kasser.com]
Sent: Monday, October 22, 2001 8:47 AM
To: Eliot I. Bernstein; Eliot Bernstein (I-View-It)
Subject: Larry

Eliot,

Brad Shraiberg, our bankruptcy attorney called me this morning. He had spoken with Larry last week, after the Crossbow meeting. Brad related to me that Larry had told him that Crossbow had not funded us, did not want to go into Chapter 11, and wanted to liquidate the company.

I told Brad that I was unclear as to for whom Larry actually worked. I asked Brad to avoid talking to Larry until I had clarification.

As you have seen from my e-mail to Aidan, neither Aidan no Larry has a valid contract with us as per our records. Aidan's contract expired August 15, 2001 and would have had to been renewed in writing. Unless you know something I don't, Aidan's agreement was not renewed.

If Larry is working for Crossbow, it certainly represents bad faith for him to be talking to our attorney.

Bill

Incoming mail is certified Virus Free.
Checked by AVG anti-virus system (<http://www.grisoft.com>).
Version: 6.0.474 / Virus Database: 272 - Release Date: 4/18/2003



Lorraine Christine Hoffman, Esq.
Assistant Staff Counsel
The Florida Bar
File No. 2003-51, 109(15C)

Eliot Bernstein than contacts Aidan Foley and we submit:

Page 1 of 2

Eliot I. Bernstein

Subject: FW: iviewit Board vote

Importance: High

-----Original Message-----

From: Eliot I Bernstein [mailto:res0bf4a@verizon.net]

Sent: Sunday, October 21, 2001 6:48 PM

To: Aidan P. Foley (E-mail); Aidan P. Foley (E-mail 2); Lawrence Allan Mondragon (E-mail); azdragon@aol.com
Cc: Bruce T. Prolow (E-mail); 'Donald G. Kane II (E-mail)'; 'Eliot Bernstein (E-mail)'; 'Gerald R. Lewin (E-mail)'; 'Kenneth Anderson (E-mail)'; 'Simon Bernstein (E-mail)'; Alan J. Epstein (E-mail); Alan Young (E-mail 2); Alan Young (E-mail); 'Alanis Morrisette on behalf of Allen Shapiro'; Albert W. Gortz (E-mail); Andrew R. Dietz (E-mail 2); Andrew R. Dietz (E-mail); 'Bettie Stanger on behalf of Ginger Stanger'; Brian G. Utley (E-mail 2); "Brian G. Utley \\\(E-mail\\)"; 'Brian Utley on behalf of Christopher Wheeler'; David J. Colter (E-mail 2); David J. Colter (E-mail); Donna Dietz (E-mail); 'Ellen Degeneres - On behalf of Tidal 4'; Gerald R. Lewin (E-mail 2); Gerald R. Lewin (E-mail 3); Guy T. Iantoni (E-mail 2); Guy T. Iantoni (E-mail 3); Guy T. Iantoni (E-mail); H. Hickman "Hank" Powell (E-mail 2); H. Hickman "Hank" Powell (E-mail); H. Wayne Huizenga Jr. (E-mail); 'Happy Feet Living Trust on behalf of Lisa Hendricks'; Jack P. Scanlan (E-mail 2); Jack P. Scanlan (E-mail); James A. Osterling (E-mail); James F. Armstrong (E-mail); James R. Jackoway (E-mail); Jeffrey Friedstein (E-mail 2); Jeffrey Friedstein (E-mail); Jill Iantoni (E-mail); "Jude Rosario \\\(E-mail 2\\)"; Kenneth Rubenstein (E-mail); Kevin J. Lockwood (E-mail 2); Kevin J. Lockwood (E-mail); 'Lauren Lyod Living Trust on behalf of Allen Shapiro and Lisa Hendricks'; Lisa Sue Friedstein (E-mail); Mara Lerner Robbins (E-mail); 'Maurice'; Maurice R. Buchsbaum (E-mail); "Michael A. Reale \\\(E-mail 2\\)"; Michael A. Reale (E-mail); Michele M. Mulrooney (E-mail); Mitchell Welsch (E-mail 2); Mitchell Welsch (E-mail); Mitchell Welsch (E-mail); Patty & Lester Daniels (E-mail); Ravi M. Ugale (E-mail); Raymond T. Hersh (E-mail 2); Raymond T. Hersh (E-mail); René P. Eichenberger (E-mail); Ross Miller (E-mail 2); Ross Miller (E-mail); Stephen J. Warner (E-mail 2); Stephen J. Warner (E-mail); Steve L. Sklar (E-mail 2); Steve L. Sklar (E-mail 3); Steve L. Sklar (E-mail); William E. Schott (E-mail); Zakirul Shirajee (E-mail 2); Zakirul Shirajee (E-mail 3); Zakirul Shirajee (E-mail)

Subject: RE: iviewit Board vote

Importance: High

Aidan,

Based on the current state of affairs brought on by the rejection by Crossbow of the proposal you and Larry developed with Crossbow to prepack the BK and not a plan to convert the debt to equity with a WB investment and begin collecting revenue for the shareholders, I am asking that all matters of any interest to the Company be approved by the Board first. We were not aware that the plan Larry was preparing with Crossbow was to eliminate the shareholders.

I am not sure how we got sidetracked on the way to the Forum, but before you began running the Company with Crossbow, the Board and shareholders thought we had brought you on Board to secure WB investment/license. As we both heard at the WB meeting they are very interested in our technology and are currently using it in multiple markets and were working with the heads of the AOL fund as well. I feel that they were also under the impression that everything was fine and that you were moving to take meetings with their management with a business plan that showed how we would all make money. Instead we were all confused with this package that has no Board approval that tries to create the illusion that the company is in imminent need of re-organization. We are not at all BK when you consider that on an AOLTW investment/license the company's creditors would all convert claims to equity, and since almost all of it is Crossbow and their friends (the company's advisors & also shareholders), it would behoove me to think that they would not convert in the face of AOLTW investment money, I have already polled a large percent and we have total compliance so far. Nobody is standing to put the Company into BK but these folks and they are the big winners on the other end, something sounds weird, when they are your

4/25/2003



Lorraine Christine Hoffman, Esq.
Assistant Staff Counsel
The Florida Bar
File No. 2003-51, 109(15C)

Page 2 of 2

partners.

I am still amazed that with all of your conversations with Larry, Hank and Steve, and the trips to and fro West Palm to meet with Crossbow that this was the plan you created. Is this your only option for the Company or do have other options for the Company, and who authorized a pre-packed bk for the shareholders? I fail to see how you were in such close contact with Crossbow, telling me to "take a vacation on company funds" last week and then left the Company with almost 3 months of unpaid bills, insurance, rent, payroll, etc. Larry was very blunt in telling me that he did not represent me and that he represented the Company which was being run by you and Crossbow. I thought the Board had hired you as our advisor?

I await your response since the company has technically been being represented by you and Larry and we need to know about the bank accounts you opened with Crossbow and the allocation of all funds under your management. We will need Larry to return all Corporate documents and the likes. I am unclear what side of the fence you are on but I will await your response. I appreciate that unlike Larry when asked to come to the meeting that you attended knowing that Crossbow would not be funding your/their plan. I am also pleased to hear that you will be managing the company for the 6 weeks that John promised to return and investment decision in. I think as you have reiterated many times after talking with our and your contacts at the major studios, that the company has "legs".

I would like you to attend the Board meeting this week, to explain where and why we are going this direction and what has happened, since you have really kept me out of any management decisions and now I am being forced to act. I need you to explain that WB has told you that they are using the product, what you and Greg valued their account alone at and present all your plans for reorganization based on these facts and the fact that most of the debt will convert with investment.

Thank you,

Eliot I. Bernstein
Founder & Vice Chairman

4/25/2003



Lorraine Christine Hoffman, Esq.
Assistant Staff Counsel
The Florida Bar
File No. 2003-51, 109(15C)

Then from the CFO at the time Mr. Bill Kasser we find the following letter and a cease and desist letter to the management to refrain from making Crossbow induced decisions without Board approval.



Lorraine Christine Hoffman, Esq.
Assistant Staff Counsel
The Florida Bar
File No. 2003-51, 109(15C)

Eliot I. Bernstein

Subject: FW: Transfer from Wells Fargo Bank
Importance: High



RE: iviewit Board
vote

-----Original Message-----

From: Eliot I Bernstein [mailto:res0bf4a@verizon.net]
Sent: Saturday, October 27, 2001 2:42 PM
To: Friedstein, Jeff; Jeffrey Friedstein (E-mail 2)
Subject: FW: Transfer from Wells Fargo Bank
Importance: High

read whole thing

-----Original Message-----

From: Eliot I Bernstein [mailto:res0bf4a@verizon.net]
Sent: Saturday, October 27, 2001 11:41 AM
To: David J. Colter (E-mail); David J. Colter (E-mail 2); Alan J. Epstein (E-mail); Michele M. Mulrooney (E-mail)
Subject: FW: Transfer from Wells Fargo Bank
Importance: High

-----Original Message-----

From: Eliot I Bernstein [mailto:res0bf4a@verizon.net]
Sent: Saturday, October 27, 2001 11:36 AM
To: 'bill@kasser.com'; Aidan P. Foley (E-mail); Aidan P. Foley (E-mail 2); 'azdragon@aol.com'; Bruce T. Prolow (E-mail); 'Donald G. Kane II (E-mail)'; 'Eliot Bernstein (E-mail)'; 'Gerald R. Lewin (E-mail)'; 'Kenneth Anderson (E-mail)'; 'Simon Bernstein (E-mail)'
Subject: RE: Transfer from Wells Fargo Bank
Importance: High

Bill - Tell Larry that per the Board meeting and letters to him and Aidan on 10.21, I informed them that they could make no such type of transactions as they were allowed before, without a board approval. Those revoked options were attached to my email, which I've attached. Please notify Larry that any such attempts to transact unauthorized company expenses for him or anyone else would I think be close to criminal, considering under their prior management they have left us with 2 months of unpaid bills, payroll taxes, etc...

Dated 10.21 I sent this to Aidan and Larry and the Board
Aidan,

"Based on the current state of affairs brought on by the rejection by Crossbow of the proposal you and Larry developed with Crossbow to prepack the BK and not a plan to convert the debt to equity with a WB investment and begin collecting revenue for the shareholders, I am asking that all matters of any interest to the Company be approved by the Board first. We were not aware that the plan Larry was preparing with Crossbow was to eliminate the shareholders." The matters that were revoked are listed in the Board memo



Lorraine Christine Hoffman, Esq.
 Assistant Staff Counsel
 The Florida Bar
 File No. 2003-51, 109(15C)

that I attached to that email, see attached email.

-----Original Message-----

From: Eliot Bernstein
 Sent: Wednesday, September 05, 2001 9:08 AM
 To: Aidan Foley (E-mail); Aidan Foley (E-mail 2); Simon L. Bernstein (E-mail)
 Subject: FW: iviewit Board vote

-----Original Message-----

From: Don Kane [mailto:dg_kane@msn.com]
 Sent: Wednesday, September 05, 2001 8:55 AM
 To: Eliot Bernstein
 Subject: Re: iviewit Board vote

----- Original Message -----

From: Eliot Bernstein
 Sent: Tuesday, September 04, 2001 10:39 PM
 To: Aidan P. Foley (E-mail); Aidan P. Foley (E-mail 2); Larry Mondragon; Lawrence Allan Mondragon (E-mail 2); Lawrence Allan Mondragon (E-mail 3); Bruce T. Prolow (E-mail 2); Bruce T. Prolow (E-mail); Donald G. Kane II (E-mail); Eliot Bernstein (E-mail); Gerald R. Lewin (E-mail); Kenneth Anderson (E-mail); Maurice R. Buchsbaum (E-mail 2); Maurice R. Buchsbaum (E-mail); Ross Miller (E-mail 2); Ross Miller (E-mail); Simon Bernstein (E-mail)
 Subject: iviewit Board vote

Dear Board Members,

The following is a resolution submitted for your review and vote. Please provide a vote via email. If you have any questions please feel free to call me at any of the numbers listed below.

(BILL I THINK YOU WILL SEE THAT AFTER REJECTING

"Be it resolved that the Board of Directors of Iviewit Holdings, Inc. (hereinafter, the "Company") does hereby vest in Aidan Foley the right and authority to do any of the following: (a) to direct and manage the business affairs of the Company and any of its subsidiaries, (b) to authorize the expenditure of funds in accordance with the Company's operating budget, subject to such capital allocations as are approved by the Board of Directors, (c) to designate members of a management team to assist in the day-to-day operations of the Company and to enter into appropriate employment agreements with such persons consistent with the Company's operating budget, and (d) to execute any other legal contracts on behalf of the Company, including any agreements which are intended to compromise or settle third party claims against the Company."

VOTE

YES IN FAVOR
 NO NOT IN FAVOR

The current management shall include;

Aidan Foley
 Lawrence Mondragon
 Eliot I. Bernstein

VOTE

YES IN FAVOR
 NO NOT IN FAVOR



Lorraine Christine Hoffman, Esq.
Assistant Staff Counsel
The Florida Bar
File No. 2003-51, 109(15C)

-----Original Message-----

From: Bill Kasser [mailto:bill@kasser.com]
Sent: Friday, October 26, 2001 8:33 AM
To: Eliot I. Bernstein; Eliot Bernstein (I-View-It); simon@adelphia.net
Subject: Transfer from Wells Fargo Bank

Si & Eliot,

As you are aware from my e-mails, I have been attempting to get Larry Mondragon to wire transfer to our account at First Union, the balance at Wells Fargo Bank. Expecting that with that money I could pay for the D&O coverage and Eliot's medical insurance. Because it is inconvenient for Larry to go to the bank to authorize the wire transfer, I will not have the money until the middle of next week (estimated). Further, while Larry has left us in the position of having to catch up payroll tax deposits, we will not have sufficient funds to do so because he is deducting from the money returned expense reimbursements for himself and Aidan. I go into more detail in the memo attached.

In summary, we need to Fedex a check today for \$1,162.93 to keep the D&O coverage in effect. Additionally, we will need to have a certified check or money order for \$1,343.74 to have Eliot's medical coverage reinstated. As Larry is sending us a check originated by an online transaction, there will be days added to the receipt of the money from Larry until we have good funds for the certified check or money order.

Is there any way that we can raise some money today?

Bill

October 26, 2001

To: Simon Bernstein, Eliot Bernstein

From: Bill Kasser

Re: Payroll Taxes

We find ourselves in a difficult situation today with regard to payroll taxes and insurance due to the actions of Larry Mondragon. To summarize; the payroll taxes from four payrolls have not been deposited. I first became aware of this situation this past Tuesday, October 23, 2001, in the evening when in a telephone conversation I asked Larry to download and e-mail to me a statement on the Wells Fargo bank account so that I could reconcile the account and give Larry an amount that he could order transferred to our account here at First Union National Bank. I expected, that as there had been no recent activity in the account, the balance would be \$4,486.65, with allowances for outstanding checks and possible bank service charges that I would not be aware of. I was surprised when Larry told me that the balance per the bank on the online statement was \$17,121.99. I asked Larry to e-mail to me the statement so that I could investigate. I also had him read to me the entries on the statement. From his reading it was apparent what had happened. A formal bank reconciliation procedure the next day (copies are in my files) confirmed my assumption from the previous night. The difference exists because \$12,880.12 in payroll tax deposits had not been made.

That amount is the payroll taxes due from four bi-weekly payrolls. \$9,225.37 was a wire transfer to our payroll processor, ADP, which was requested of Wells Fargo Bank on September 18, 2001. That amount represents the payroll taxes from three payrolls. We originally got behind on payroll taxes by one payroll in May. We got behind a second payroll in August. This transfer would catch us up and make the deposit on a current payroll. It was important that we catch up by September 30, 2001, the end of the quarter, so that full payment would be reflected on the quarterly payroll tax returns. I had directed Larry to confirm to Wells Fargo Bank the wire that I had



Lorraine Christine Hoffman, Esq.
Assistant Staff Counsel
The Florida Bar
File No. 2003-51, 109(15C)

requested, as I did not have authority to order the transaction myself. On September 24, 2001, I receive a telephone call from Rita at ADP saying that the wire had not been received. Normally, ADP would debit our bank account directly for payroll taxes, by previous agreement, but owing to the action brought by Brian Utley, et al, they required us to initiate the transfer. I sent Larry an e-mail that day at 1:42 PM our time telling him that the transfer had not been made and requesting that he take action to get it done. Incidentally, the amount that should have been transferred was \$9,325.37, the amount reflected in that e-mail. On September 25, 2001 at 3:13 PM Larry sent me an e-mail, blaming the bank for the wire transfer not being made and asking if the "sky would fall" if the transfer were not made until tomorrow. As ADP was threatening to discontinue filing our taxes if we were late with the deposit, I called Rita there and arranged for another day. Based on Larry's assertion in his e-mail that he would have the transfer done the next day, I committed to have it there in exchange for their forbearance in canceling our tax filing service. I told Larry that in an e-mail sent at 3:57PM on September 25, 2001.

The wire was actually made September 28, 2001. It was also made for \$9,225.37. ADP told me that because it was late they would discontinue filing our payroll taxes for us. That was done by Rita in a phone call on Monday, October 1, 2001. She did not tell me that they would not accept the wire. September 28, 2001 was also a payday. I had prepared and forwarded pay checks to Larry on September 26, 2001, and told him that I would give him the amount for a wire for payroll taxes. As we still had not made the transfer for the last amount, I wanted to hold off on the wire until that one had been done. On October 4, 2001, I drew a check, in the amount of \$3,654.74 for the payroll tax deposit, as I was unable to negotiate a reinstatement with ADP and sent it, with the deposit form, to Larry for his signature and instructed him to forward the check to the bank where they could accept it for the taxing authorities. It appears that Larry did not make this deposit.

This past Wednesday, October 24, 2001, as you are aware from e-mails that I have copied to you, I requested that Larry wire transfer to our account at First Union National Bank the balance in the account, less bank fees necessary to process the wire and close the account. I had planned to make the payroll tax deposits. Additionally, I was going to prepare checks to have the United Healthcare medical insurance reinstated and the cancellation notice on the Directors and Officers Liability Insurance rescinded. After several phone calls to Larry yesterday, Larry called back at approximately 7:00 PM our time. He told me that he would send back \$11,758.55. That amount represented the balance of \$17,121.99 less \$5,313.44 for expenses for him and Aidan (detailed in a subsequent e-mail to me) and \$50.00 to cover expenses of closing the account. Further, the amount would come to us via an online payment, a check which the bank writes and mails based on an order he transmits to them through the bank's website. Accordingly, we cannot expect the money until the middle of next week. The reason that Larry cited for not doing a wire transfer, and the reason for the afore mentioned late wire transfer and other similar problems is that Wells Fargo Bank requires that he come into the bank and sign for the wire and that is inconvenient for him as he lives some distance from the bank.

We did not choose Wells Fargo Bank. Larry should have dealt with their location and policies. He has put us in a difficult position with regard to both the payroll taxes and insurance. While he and Aidan may be entitled to expense reimbursements, I believe they have a responsibility, first to see that the payroll taxes are deposited and second to not put us in a position where the Board is without D & O coverage.

Incoming mail is certified Virus Free.
Checked by AVG anti-virus system (<http://www.grisoft.com>).
Version: 6.0.427 / Virus Database: 240 - Release Date: 12/6/2002

4

Then Crossbow wanted to start speaking with our Warner contacts and we submit:



Lorraine Christine Hoffman, Esq.
Assistant Staff Counsel
The Florida Bar
File No. 2003-51, 109(15C)

From: Powell, Hank [HPowell@cb-ventures.com]
Sent: Thursday, January 17, 2002 10:27 AM
To: 'PSLamont39@aol.com'; 'res0bf4a@verizon.net'; 'bill@kasser.com'
Cc: Warner, Steve; Patten, Mark; 'dwuersch@wg-law.com'; 'mberenson@wg-law.com'
Subject: FW: Today -- iviewit

Stephen, Thanks for the telephone conversation with Mark and I today. I look forward to details of the January 21st court date with Proskauer Rose later today. In the meantime, I found the first reference in email which I received from Warner about the introduction of the company to the AOLTW investment committee, of which Heidi Krauel is a member. Please keep us informed as soon as anything tangible happens. I reiterate my need for direct communication with AOLTW to ascertain the likely outcome with respect to investment or current revenue opportunities. Thanks, Hank

Hank Powell
Managing Director
CrossBow Ventures
One North Clematis Street
Suite 510
West Palm Beach, FL 33401
tel. 561-838-9005
fax 561-838-4105
email HPowell@cb-ventures.com

-----Original Message-----

From: David.Colter@warnerbros.com [mailto:David.Colter@warnerbros.com]
Sent: Thursday, August 02, 2001 1:28 AM
To: HeidiKrauel@aol.com
Cc: HPowell@cb-ventures.com; Eliot@iviewit.com
Subject: Re: Today -- iviewit

Heidi,

Here is the info for Hank Powell from Crossbow Ventures. I have copied him above to make the introduction.

iviewit has undergone a restructuring of their business from an encoding focused business to a technology licensing business focus over the past 4-5 months. They are in the process of establishing a new executive team to handle this 'new' direction and have been working on the new business plan. They have indicated that we should have the revised plan next week.

They currently are finalizing a contract with WB Online to provide encoding services as a hold over from our original collaboration, and as a showcase for the technologies and patents.

Their site www.iviewit.com contains good demonstrations of the zooming and video encoding technologies. I have also copied the inventor/founder Eliot Bernstein, who I will ask to provide some specific links on the site to see the best representation of their work and technical capabilities.

Their patents are pending, but have received favorable opinions from people such as Ken Rubenstein on the merit of the patents, as well as thorough review by Greg Thagard and myself.

Let's talk further after you see the business plan and connect with Hank.

Thanx,
David

Hank Powell



Lorraine Christine Hoffman, Esq.
Assistant Staff Counsel
The Florida Bar
File No. 2003-51, 109(15C)

Page 2 of 2

review by Greg Thagard and myself.

Let's talk further after you see the business plan and connect with Hank.

Thanx,
David

Hank Powell
Managing Director

CrossBow Ventures
One North Clematis Street
Suite 510
West Palm Beach, FL 33401-5523
T +1(561) 838-9005 (office)
T +1(561) 279-0556 (home)
T +1(561)310-9171 (cellphone)
F +1(561) 838-4105
HPowell@cb-ventures.com
www.cb-ventures.com

In a message dated 07/26/2001 8:01:54 AM Pacific Daylight Time, HeidiKrauel writes:

Subj:**Re: Today**
Date:07/26/2001 8:01:54 AM Pacific Daylight Time
From:HeidiKrauel
To:David.Colter@warnerbros.com (DColter0264)
Sent on: AOL 6.0 for Windows US sub 10531

In a message dated 7/26/01 10:47:13 AM Eastern Daylight Time, David.Colter@warnerbros.com (DColter0264) writes:

Any times good for you before 10 am PST?

stepping into meeting now until 2:30pm EST. I can do tomorrow too...

Heidi Krauel
Associate
AOL Time Warner Ventures
22000 AOL Way
Dulles, VA 20186
Phone - 703 265 1134
Fax - 703 265 3925
Email - heidikrauel@aol.com

Incoming mail is certified Virus Free.
Checked by AVG anti-virus system (<http://www.grisoft.com>).
Version: 6.0.474 / Virus Database: 272 - Release Date: 4/18/2003

4/25/2003



Lorraine Christine Hoffman, Esq.
Assistant Staff Counsel
The Florida Bar
File No. 2003-51, 109(15C)

Then Crossbow contacted Warner Bros. directly to demand to speak with our representatives and further compounded the problems created at Warner Bros. forcing the following correspondence to be sent:

-----Original Message-----

From: Epstein, Alan [mailto:AEpstein@AHJTW.com]
Sent: Wednesday, October 24, 2001 4:36 PM
To: 'Eliot I. Bernstein'
Subject: RE: Cease & Desist

what did they say to colter?

-----Original Message-----

From: Eliot I. Bernstein [mailto:eliot@iviewit.com]
Sent: Wednesday, October 24, 2001 1:10 PM
To: H. Hickman "Hank" Powell (E-mail); H. Hickman "Hank" Powell (E-mail 2); Stephen J. Warner (E-mail); Stephen J. Warner (E-mail 2); Ravi M. Ugale (E-mail); René P. Eichenberger (E-mail)
Cc: Bruce T. Prolow (E-mail); Donald G. Kane II (E-mail); Eliot Bernstein (E-mail); Gerald R. Lewin (E-mail); Kenneth Anderson (E-mail); Maurice R. Buchsbaum (E-mail 2); Maurice R. Buchsbaum (E-mail); Ross Miller (E-mail 2); Ross Miller (E-mail); Simon Bernstein (E-mail)
Subject: Cease & Desist

Dear Crossbow,

Please kindly cease and desist from contacting I View It customers and potential investors, unless authorized by an officer or the Board. Your calls to David Colter today may negatively impact the ability of the company in it's negotiations with our client and potential investor.

Eliot

And then continued interference by Crossbow led to this letter:



Lorraine Christine Hoffman, Esq.
Assistant Staff Counsel
The Florida Bar
File No. 2003-51, 109(15C)



Tuesday, November 20, 2001

H. Hickman "Hank" Powell
Managing Director
Crossbow Ventures™
One North Clematis Street, Suite 510
West Palm Beach, FL 33401

Dear Mr. Powell:

I View It is surprised at your demand for interest on your loans at this point in time when you have lapsed financing to the company with over 2 months of overdue bills you had promised the management team you were working closely with, you would pay. iviewit Holdings, Inc. and its subsidiaries have relied on these representations made to its management and directors by your firm with regard to the commitment of your firm to fund its activities through the execution of certain plans. We are now concerned in that the recent actions of your firm jeopardize the ability if iviewit Holdings, Inc. to carry out those plans and could put the Intellectual Property in harms way. We trust that Alpine Venture Capital Partners, LP will do those things that were promised, specifically:

- Provide funding to advance iviewit's patent applications through the necessary legal processes both in this country and in other countries believed to be viable markets for iviewit's technology.
- To provide financial support allowing the now scaled back operations of iviewit to progress through the negotiating phase with America Online, Sony, Viacomm, etc.
- Hire a competent management team to negotiate with AOLTW, Sony and others since you have now left us without management due to your interference with the team we had lined up.
- To make good on the promise to pay \$180,000 representing the two months of expenses which iviewit incurred believing that funding would be in the bank, as you had promised both Larry Mondragon and Aidan Foley. In fact, both Larry

I View It Technologies, Inc.
505 North Brand Boulevard □ Suite 1420
Glendale, CA 91203-2308
Voice 818.545.1444 □ Fax 818.545.1440



Lorraine Christine Hoffman, Esq.
Assistant Staff Counsel
The Florida Bar
File No. 2003-51, 109(15C)



and Aidan confirmed that you had transacted the money prior to leaving to visit with you in West Palm.

- Reimburse iviewit for the \$5,363.44 that Aidan Foley and Lawrence Mondragon retained when they closed the bank account they had established for iviewit in California. This amount was retained to cover expenses incurred by these two individuals, principally to make a trip to Florida on your request, to meet with you and others from your firm. Messrs. Foley and Mondragon, intentionally did not make deposits of payroll taxes as directed on behalf of iviewit, and returned an amount to iviewit less than the amount required to make those deposits, after recouping expenses the day after their trip without approval. The Company was under the assumption as were Aidan and Larry, that your \$180,000 of funds would cover the expenses racked up on their trip to meet with you, and you had verbally confirmed to Larry, Aidan and others that you had transacted these monies. We are dumbfounded that you approved these travel plans and are now sticking them on I View It versus Crossbow. Since they (Larry and Aidan) were controlling the bank account directly with your firm Crossbow we were appalled when we finally got access to the accounts that not only was the promised money not in the account but they had completely stripped out all of the monies for our payroll, etc. to recoup travel expenses incurred with your authorization.
- Make good on your promise to further the patents, Aidan, Larry and Tom Coester had worked with you to prepare the costs for these filings, approximately 200-300k, and we were under the impression that you would be financing these costs based on our conversations with management, who had assured us that you had assured them of the payments being made. We are now left with no time to raise financing that will enable the payment of those costs and this could hurt the company severely in negotiations with customers and potential investors, if the patents are not filed timely.

I View It Technologies, Inc.
505 North Brand Boulevard □ Suite 1420
Glendale, CA 91203-2308
Voice 818.545.1444 □ Fax 818.545.1440



Lorraine Christine Hoffman, Esq.
Assistant Staff Counsel
The Florida Bar
File No. 2003-51, 109(15C)



- Also, the Company has sent you a cease and desist letter to stop approaching our clients and stop trying to force on them decisions that could negatively impact our negotiations with them. It is quite embarrassing enough that because of your failure to pay the prior commitments you had promised we had to stop our servicing of the WB Online account with no notice to their staff and owe their building 2 months of past rent that Larry had promised them was in the mail. It appears that even after the cease and desist you have continually called and harangued our contacts at WB without any approval from I View It management. Please stop interfering in the Company's ability to try and transact business.

From conversations with WB it appears that they are very unhappy with your recent decisions, as they were under the impression from conversations with your firm that you would be funding the Company through discussions with their investment and licensing groups. They are most surprised by your bad behavior at this stage, after they have spent considerable time, human resources and money preparing I View It for our meetings with the AOLTW Ventures group and you had not mentioned anything like this to them when you had them out to West Palm to meet with you in privacy the other week. In fact, I recall you initiating many calls to this group, although I am unsure of the outcome of your conversations since you did not have any Company representatives on the calls, but you had stated repeatedly that everything was on track.

Nobody at WB was aware that with management you would concoct a bankruptcy plan to bring to the AOLTW Venture group and certainly management had never presented this option to the Board. This is a complete embarrassment to everyone both at I View It and AOLTW.

- Remove your demand for interest due.
- Finally, work with the current management of iviewit in the furtherance of its goals with regard to patenting and licensing its technology.

Accordingly, please provide us with a date on which we may expect to receive the funds required for the payment or reimbursement of expenses incurred, including the Interest on your loans. Additionally, it must be clear that we can rely on your firm to support the operations of iviewit as it pursues the licensing of its technology. We have relied on your firm to bring us to where we are today.

I View It Technologies, Inc.
505 North Brand Boulevard □ Suite 1420
Glendale, CA 91203-2308
Voice 818.545.1444 □ Fax 818.545.1440



Lorraine Christine Hoffman, Esq.
Assistant Staff Counsel
The Florida Bar
File No. 2003-51, 109(15C)



We have come this far believing that you were committed to our continuation of our journey. It is unfair the manner in which you have failed to meet your obligations and hamstrung the company into a position of near bankruptcy to the other investors in iviewit and to the employees of the company, withdrawing your support without allowing the Company anytime to replace you with a different source of financing and allow the Company the ability to meet its goals. I trust that you will fulfill your commitments, if you are unwilling than the Company must begin to pursue your firm on many of the lender liability clauses we feel that you are in violation of and will have to consider your liability in the event the patents are endangered.

Best regards and a happy Thanksgiving,

Eliot

Eliot I. Bernstein
Founder, Vice Chairman and Secretary
I View It Technologies, Inc.

I View It Technologies, Inc.
505 North Brand Boulevard □ Suite 1420
Glendale, CA 91203-2308
Voice 818.545.1444 □ Fax 818.545.1440



Lorraine Christine Hoffman, Esq.
Assistant Staff Counsel
The Florida Bar
File No. 2003-51, 109(15C)

Then several months later CEO Stephen Lamont is negotiating through this mess caused by Crossbow and feels that he is close to signing a AOLTW license deal, closing investment funds and is working well with Crossbow to overcome the past issues as is evidenced by the following correspondence.



Lorraine Christine Hoffman, Esq.
Assistant Staff Counsel
The Florida Bar
File No. 2003-51, 109(15C)

Eliot I. Bernstein

From: Eliot I. Bernstein
Sent: Tuesday, January 29, 2002 6:47 AM
To: P. Stephen Lamont
Subject: RE: Your Call

Importance: High

way better than the ones I've been drafting, let it fly

-----Original Message-----

From: P. Stephen Lamont
Sent: Tuesday, January 29, 2002 3:29 AM
To: Eliot I. Bernstein
Subject: FW: Your Call

Best regards,

P. Stephen Lamont
Chief Executive Officer, Director
I View It Technologies, Inc.
10 Mela
Rancho Palos Verdes, Cal. 90275
Tel: 914-217-0038
Email: psl@iviewit; pstephen.lamont@verizon.net
URL: www.iviewit.com

-----Original Message-----

From: P. Stephen Lamont [mailto:psl@iviewit.com] On Behalf Of P. Stephen Lamont
Sent: Thursday, January 24, 2002 4:16 PM
To: 'Powell, Hank'
Subject: RE: Your Call

Hank:

On the large financing front, I am negotiating with an institutional salesman at Gruntal & Co. in NY as a placement agent. Their clients include Comcast Corporation and Communications Equity Associates in NY (I worked with CEA on the Thomson-DirecTV-Microsoft deal, and they bring a wealth of media contacts, financing I am not sure).

On the small financing front, I may be able to pick up two small 5-figure investments to make another payment on the Secured Note.

On the business development front, I perceive that Warner Brothers may be favorably disposed in that they asked for more information, and that information should be delivered by today PST, whereby it is only good business practice to extend the Advanced Royalty Agreement for five (5) more business days. I see it as a positive that they agree with our position that the technologies have a wider reach in that, while they use it on their money losing WOnline site, they are now evaluating it in terms of the DVD patent pool as well; meeting with Ken Rubenstein in NYC recently, I have put them in touch, and will keep you apprised.

Lastly, I would look forward to a meeting in NY when and if your travel plans put you there.

Best regards,



Lorraine Christine Hoffman, Esq.
Assistant Staff Counsel
The Florida Bar
File No. 2003-51, 109(15C)

P. Stephen Lamont
Chief Executive Officer, Director
I View It Technologies, Inc.
10 Mela
Rancho Palos Verdes, Cal. 90275
Tel: 914-217-0038
Email: psl@iviewit; pstephen.lamont@verizon.net
URL: www.iviewit.com

-----Original Message-----
From: Powell, Hank [mailto:HPowell@cb-ventures.com]
Sent: Thursday, January 24, 2002 2:55 PM
To: 'P. Stephen Lamont'
Subject: RE: Your Call

I'm out of the office at a board meeting tomorrow. I'm on a conference call at the moment. Do you have any progress? Hank

Hank Powell
Managing Director
CrossBow Ventures
One North Clematis Street
Suite 510
West Palm Beach, FL 33401
tel. 561-838-9005
fax 561-838-4105
email HPowell@cb-ventures.com

-----Original Message-----
From: P. Stephen Lamont [mailto:psl@iviewit.com]
Sent: Thursday, January 24, 2002 4:00 PM
To: Powell, Hank
Subject: Your Call

Hank,

I am running a little late today, and would like to call you in the morning when we can have a more lengthy discussion. I hope that will be alright.

Best regards,

P. Stephen Lamont
Chief Executive Officer, Director
I View It Technologies, Inc.
10 Mela
Rancho Palos Verdes, Cal. 90275
Tel: 914-217-0038
Email: psl@iviewit; pstephen.lamont@verizon.net
URL: www.iviewit.com

-----Original Message-----
From: Powell, Hank [mailto:HPowell@cb-ventures.com]
Sent: Friday, January 18, 2002 2:12 PM
To: 'P. Stephen Lamont'
Subject: RE: Regarding Proskauer

Thank you for the assurance. I assume that there's nothing nasty by way of a court date or action looming on January 21st as you had intimated. Monday morning we have a regular meeting, so Monday afternoons are best for a debriefing when you have progress to report. Thanks, Hank

Hank Powell
Managing Director



Lorraine Christine Hoffman, Esq.
 Assistant Staff Counsel
 The Florida Bar
 File No. 2003-51, 109(15C)

CrossBow Ventures
 One North Clematis Street
 Suite 510
 West Palm Beach, FL 33401
 tel. 561-838-9005
 fax 561-838-4105
 email HPowell@cb-ventures.com

-----Original Message-----
 From: P. Stephen Lamont [mailto:psl@iviewit.com]
 Sent: Friday, January 18, 2002 1:25 PM
 To: HPowell@cb-ventures.com
 Cc: SWarner@cb-ventures.com
 Subject: Regarding Proskauer

Hank,

I have just been told that "We are up to date with the Proskauer matter with regard to responses to admissions, interrogatories and production." I have inquired further as to what are the next critical steps and what the timeline might look like...I will advise at that time.

Best regards,

P. Stephen Lamont
 Chief Executive Officer
 I View It Technologies, Inc.
 10 Mela
 Rancho Palos Verdes, Cal. 90275
 Tel: 914-217-0038
 Email: psl@iviewit; pstephen.lamont@verizon.net
 URL: www.iviewit.com

 Incoming mail is certified Virus Free.
 Checked by AVG anti-virus system (<http://www.grisoft.com>).
 Version: 6.0.474 / Virus Database: 272 - Release Date: 4/18/2003

Tracking:	Recipient	Delivery
	P. Stephen Lamont	Delivered: 1/29/2002 6:47 AM



Lorraine Christine Hoffman, Esq.
Assistant Staff Counsel
The Florida Bar
File No. 2003-51, 109(15C)

Now only several days after sending this letter, the Company receives from Crossbow the following letter of demand, which killed the Company with AOLTW and the investors:



Lorraine Christine Hoffman, Esq.
 Assistant Staff Counsel
 The Florida Bar
 File No. 2003-51, 109(15C)

CROSSBOW
 VENTURES

Alpine Venture Capital Partners LP
 One North Clematis Street, Suite 510
 West Palm Beach, FL 33401

VIA FEDERAL EXPRESS
 AND CERTIFIED MAIL

February 1, 2002

Iviewit Holdings, Inc.
 10 Mela Lane
 Rancho Palos Verdes, CA 90275
 Attention: Eliot Bernstein

Re: Notice of Assignment

Gentlemen:

On December 7, 2001, Alpine Venture Capital Partners LP ("Alpine") sent Iviewit Holdings, Inc. (the "Company") a notice of an event of default under the Company's 10% Senior Secured Notes, dated May 14, 2001, June 8, 2001, July 9, 2001 and September 17, 2001 (collectively, the "Notes"), for failure of the Company to pay interest due on such Notes to Alpine after due demand had been made therefor.

Because the event of default is continuing, we hereby notify you that in accordance with Section 3 of the Amended and Restated Intellectual Property Security Agreement and Assignment, dated as of September 17, 2001, between Alpine and Iviewit Technologies, Inc. ("Iviewit Technologies"), Alpine has elected to declare effective the assignment to Alpine of all of Iviewit Technologies rights, title and interest in the intellectual property listed in Annex I through IV of the Assignment of Patents, Trademarks, Copyrights and Licenses, dated as of May 14, 2001 (the "Assignment"), between Alpine and Iviewit Technologies. A copy of the Assignment has been filed with the U.S. Patent and Trademark Office.

ALPINE VENTURE CAPITAL PARTNERS LP

By: Alpine Venture Capital Corp.,
 its General Partner

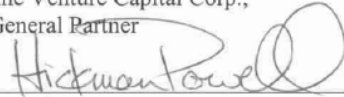
By: 
 Name: Hickman Powell
 Title: Managing Director

ONE NORTH CLEMATIS STREET • SUITE 510 • WEST PALM BEACH • FL 33401-5523 • T 561 838 9005 • F 561 838 4105 • www.cb-ventures.com



Lorraine Christine Hoffman, Esq.
 Assistant Staff Counsel
 The Florida Bar
 File No. 2003-51, 109(15C)

Then we received from our patent counsel BSTZ the following letter, which was after we had requested Crossbow not to contact our patent attorneys, we submit:

Feb-11-2002 05:25pm From-BSTZ LA

3108205988

T-033 P.001/003 F-690

**BLAKELY
 SOKOLOFF
 TAYLOR &
 ZAFMAN LLP**

12400 Wilshire Boulevard, Seventh Floor
 Los Angeles, California 90025-1026
 Telephone: (310) 207-3800
 Facsimile: (310) 820-5988 or 820-5270

FACSIMILE TRANSMITTAL SHEET

Deliver To: Stephen Lamont
Company: Iviewit Technologies, Inc.
Fax: (845) 279-7710
From: Thomas M. Coester, Esq.
Date: February 11, 2002
Time: _____
Number of Pages: 3 (Including Cover Sheet)
Operator: Susan M. Ocegueda
Your Reference: _____
Our Reference: 005707.G000

SUBJECT:
REMARKS:

CONFIDENTIALITY NOTE: The documents accompanying this facsimile transmission contain information from the law firm of Blakely, Sokoloff, Taylor & Zafman which is confidential or privileged. The information is intended to be for the use of the individual or entity named on this transmission sheet. If you are not the intended recipient, be aware that any disclosure, copying, distribution or use of the contents of this faxed information is prohibited. If you have received this facsimile in error, please notify us by telephone immediately so that we can arrange for the retrieval of the original documents at no cost to you.

If you do not receive all the pages, or if there is any difficulty in receiving, please call: (310) 207-3800 and ask for the operator named above.



Lorraine Christine Hoffman, Esq.
 Assistant Staff Counsel
 The Florida Bar
 File No. 2003-51, 109(15C)

Feb-11-2002 05:25pm From-BSTZ LA

3108205988

T-033 P.002/003 F-690

BLAKELY SOKOLOFF TAYLOR & ZAFMAN
 A LIMITED LIABILITY PARTNERSHIP INCLUDING LAW CORPORATIONS

TELEPHONE (310) 207-3800
 FACSIMILE (310) 820-5888
 (310) 820-5270
 BSTZ_MAIL@BSTZ.COM
 WWW.BSTZ.COM

INTELLECTUAL PROPERTY LAW
 12400 WILSHIRE BOULEVARD
 SEVENTH FLOOR
 LOS ANGELES, CALIFORNIA 90025-1030

OTHER OFFICES
 AUSTIN, TX
 SILICON VALLEY/SAN JOSE, CA
 ORANGE COUNTY/COSTA MESA, CA
 SAN DIEGO/LA JOLLA, CA
 PORTLAND/LAKE OSWEGO, OR
 SEATTLE/KIRKLAND, WA
 DENVER/ENGLEWOOD, CO

February 11, 2002

ATTORNEY-CLIENT PRIVILEGED
CONFIDENTIAL COMMUNICATION

VIA FACSIMILE (845) 279-7710

Stephen Lamont
 Iviewit Technologies, Inc.
 4 Ward Street
 Brewster, New York 10509

Re: Iviewit.com, Inc.
Notice of Assignment Dated February 1, 2002

Dear Stephen:

As I believe you are aware, Blakely, Sokoloff, Taylor & Zafman has been prosecuting various patent applications for Iviewit. Those applications are enumerated in the attached Status Report. In the course of those prosecutions, we have periodically interfaced with Hank Powell of Crossbow Ventures (which is apparently affiliated with Alpine Ventures Ltd) who, as you know, provided some of the funding of the foreign filing and ongoing prosecution efforts. In that connection, Bill Kasser had instructed us to provide Hank Powell whatever information he requested and keep him informed of the progress of various applications, and we have done so.

As we discussed on a telephone conference two days ago, we received a copy of the letter to Iviewit indicating that Alpine Ventures Capital Partners Ltd. ("Alpine") has declared effective the assignment of various Iviewit intellectual property to Alpine. As I do not have Annex I through Annex IV of the assignments of patents, trademarks, copyrights and licenses referred to in that letter, I do not know which pieces of intellectual property exactly are affected. However, Hank Powell requested that this Firm continue to prosecute the patents on behalf of Alpine. In view of the fact that Iviewit objects to Alpine's action and contend that the Assignment may be invalid, the ownership of the intellectual property at issue is murky at best. As this is a commercial dispute, outside the scope of our representation, we are unable to advise you connection with this matter. When the situation arose, I was in the process of preparing a packet of information for Hank regarding cases foreign filed and the Preliminary Amendments previously filed. However, in view of these events, I have placed that packet on hold pending a resolution.

As you are no doubt aware, patent practice has many time sensitive deadlines which if missed cause rights to be forever lost. Most notable in terms of upcoming deadlines is the deadline to file a response to an Office Action in connection with the earlier filed of the two image related cases. That deadline with maximum extension is now less than a month away.



Lorraine Christine Hoffman, Esq.
 Assistant Staff Counsel
 The Florida Bar
 File No. 2003-51, 109(15C)

Feb-11-2002 05:26pm From-BSTZ LA

3108205988

T-033 P.003/003 F-690

BLAKELY SOKOLOFF TAYLOR & ZAFMAN
 A LIMITED LIABILITY PARTNERSHIP INCLUDING LAW CORPORATIONS

Stephen Lamont
 Iviewit Technologies, Inc.
 February 11, 2002
 Page 2

Other deadlines are certain to arise and in certain cases may be quite short. Accordingly, we need to identify how best to insure that no rights are lost while the above-reference commercial dispute is resolved.

We understand that Iviewit cannot currently afford to pay for our services, but that Iviewit would like to protect the intellectual property that is subject of the existing patent applications. If Iviewit wishes us to continue to prosecute the various patent and possibly trademark applications based on instruction and payment by Alpine, we need you to authorize us to do so by signing below. In that connection, we will keep both Alpine and Iviewit fully informed of developments in the prosecution. If I am going to prosecute these patents, I need to be free to share all relevant information with both Iviewit and Alpine. By signing this letter, you are authorizing me to do so. In the event that Alpine Ventures elects not to pay to maintain or continue to prosecute a particular application, Iviewit may instruct us to maintain that piece of intellectual property and we will do so, but only if Iviewit pays for our services in advance as we cannot agree to render further services for free. This arrangement whereby Alpine pays for our services will keep the intellectual property alive while you resolve the ownership issues. We will also obtain an agreement from Alpine Ventures that our continued prosecution of intellectual property is without prejudice to the right of Iviewit to challenge Alpine's ownership of that property.

If this proposal is acceptable to you, please sign where indicated below and return this letter to me by facsimile and the original by mail. If you have questions or concerns, please do not hesitate to contact me.

Very truly yours,

BLAKELY, SOKOLOFF, TAYLOR & ZAFMAN

Thomas M. Coester

cc: Eliot Bernstein
 TMC/smo

Date: _____

By: _____
 Stephen Lamont

Which led to the following letter from Lamont to Hank Powell and the patent office:



Lorraine Christine Hoffman, Esq.
Assistant Staff Counsel
The Florida Bar
File No. 2003-51, 109(15C)



Iviewit Holdings, Inc.
10 Mela
Rancho Palos Verdes, Cal. 90275

By Federal Express and Certified Mail

February 7, 2002

Hickman Powell
Managing Director
Alpine Venture Capital Corp.
One North Clematis Street
West Palm Beach, Fla. 33401

Re: Notice of Assignment Dated February 1, 2002

Dear Mr. Powell:

We are in receipt of your above referenced correspondence, and due to a myriad of situational steps taken by Alpine Venture Capital Partners LP, its General Partner, Alpine Venture Capital Corp, their affiliate Crossbow Ventures, LP, and Hickman Powell (collectively, "Alpine"), too numerous to enumerate in this response, and pursuant to the 10% Senior Secured Notes dated May 14, 2001, June 8, 2001, July 9, 2001, and September 17, 2001 (collectively, "Notes"), we are of the opinion that your purported assignment is ill-fated, unsupportable by the facts represented in the relationship surrounding Alpine, the Notes, and Iviewit Holdings, Inc. ("Company"), and, therefore, of no particular effect.

Accordingly, the Company maintains, and a copy of this response has been filed with the United States Patent and Trademark Office, that:

1. The Company has all requisite, unilateral corporate power and authority, without limitation, for the ownership and operation of its Properties (as defined below) and for the carrying on of its business as now conducted and as proposed to be conducted;
2. The Company has the requisite, unilateral power and authority, without limitation, to execute and deliver advanced royalty agreements, license agreements, and any and all other transaction documents, without limitation (collectively, "Agreements") to which it is a party, and to perform its obligations thereunder and to consummate the Agreements contemplated thereby;
3. The execution and delivery by the Company of Agreements to which it is a party and the performance by the Company of its obligations thereunder and the consummation of the transactions contemplated thereby are and will be duly and validly authorized by all



Lorraine Christine Hoffman, Esq.
Assistant Staff Counsel
The Florida Bar
File No. 2003-51, 109(15C)



Hickman Powell
February 7, 2002
Page 2

necessary corporate action;

4. Agreements are and will be duly and validly executed and delivered by the Company and constitute, and upon the execution and delivery by the Company of Agreements (to which it is a party), each such Agreement will constitute, the legal, valid and binding obligation of the Company, in each case enforceable against the Company in accordance with its terms;

5. The execution and delivery by the Company of Agreements (to which they are a party), the performance by the Company of their obligations thereunder and the consummation of the transactions contemplated thereby does not and will not: (i) conflict with or result in a violation or breach of any of the terms, conditions or provisions of the certificate or articles of incorporation or organization or by-laws of the Company; and (ii) conflict with or result in a violation or breach of any term or provision of any law or order applicable to the Company or any of their assets and Properties;

6. The Company is a corporation, validly existing and in good standing under the laws of its jurisdiction of incorporation or organization and has full unilateral power and authority, without limitation, to conduct its business as presently conducted and to own, use and lease its assets and Properties;

7. The Company has all right, title and interest in or a valid and binding license to use all of its Properties, without limitation, subject to the conduct of its business, and shall continue to have all right, title, and interest in its Properties until such time, if ever, as it is adjudged to the contrary by a U.S. or State Court of competent jurisdiction; and

8. For purposes of 1 to 7 above, Properties shall mean the intellectual property listed in Annex I through Annex IV of the Assignment of Patents, Trademarks, Copyrights, and Licenses dated as of May 14, 2001 by and between Alpine and Iviewit Technologies, Inc.

Very truly yours,

Iviewit Holdings, Inc.

By: _____
Name: P. Stephen Lamont
Title: Chief Executive Officer

Cc: Stephen Warner
Thomas Coester



Lorraine Christine Hoffman, Esq.
Assistant Staff Counsel
The Florida Bar
File No. 2003-51, 109(15C)

We submit further in this matter:

Eliot I. Bernstein

Subject: FW: Your Voice Message

-----Original Message-----

From: P. Stephen Lamont
Sent: Monday, February 04, 2002 1:14 PM
To: HPowell@cb-ventures.com; SWarner@cb-ventures.com
Cc: Bill R. Kasser; Eliot I. Bernstein
Subject: Your Voice Message

Gentleman:

Coming back into cell phone and email range, I was delighted to receive your message, and was dialing the phone and looking forward to a productive discussion on the status of the company. Unfortunately, at the same time, I reviewed a forwarded email from Eliot Bernstein that contained your Notice of Assignment sent to the company, and was equally dismayed by this action you have chosen to take. Accordingly, I see no opportunity to respond and converse today, prior to conversations with the company's outside commercial law counsel.

Dismayed, yes, as I was looking forward bringing the company to the next level for the first time in its history, combining both business development and future funding discussions again this week, but it seems as if you have chosen to divert my attention to less productive matters. Furthermore, I can assure you that this new development and proactive deed you have seen necessary to take, will now receive my immediate and full attention to this discredit of other areas I have commenced. I hope to be in touch with you in the next several days, and in the interim, please notify me of your legal representation pertaining to your actions under the aforementioned Notice of Assignment.

Lastly, not known for my lack of experience in these areas and receiving the bulk of my training in New York, please do not take offense when I, on behalf of the company, reply in kind; I had hoped, and I still have hope, that we could have ventured forward together as opposed to spending the next five years pouring funds into pockets other than our own.

Finally, should said Notice of Assignment have been sent in haste or error, I will take it in stride as we are all human, and feel free to reply and advise. If not, I shall be in touch with you or your legal representation in due course.

Best regards,

P. Stephen Lamont
Chief Executive Officer, Director
I View It Technologies, Inc.
10 Mela
Rancho Palos Verdes, Cal. 90275
Tel: 914-217-0038
Email: psl@iviewit; pstephen.lamont@verizon.net
URL: www.iviewit.com

Incoming mail is certified Virus Free.
Checked by AVG anti-virus system (<http://www.grisoft.com>).
Version: 6.0.474 / Virus Database: 272 - Release Date: 4/18/2003



Lorraine Christine Hoffman, Esq.
 Assistant Staff Counsel
 The Florida Bar
 File No. 2003-51, 109(15C)

We submit further evidence that Crossbow was dealing with Iviewit patent counsel against Company direction both to Crossbow and patent counsel.

Eliot I. Bernstein

From: P. Stephen Lamont [pstephen.lamont@verizon.net]
Sent: Thursday, April 25, 2002 1:39 AM
To: Simon L. Bernstein (E-mail); Caroline P. Rogers; Eliot I. Bernstein
Subject: Fw: Crossbow

----- Original Message -----

From: <Tom_Coester@bstz.com>
 To: "P. Stephen Lamont" <pstephen.lamont@verizon.net>
 Sent: Wednesday, April 10, 2002 7:22 PM
 Subject: Re: Crossbow

>
 >
 >
 >
 >
 >
 > "P. Stephen Lamont" <pstephen.lamont@verizon.net> on 04/24/2002 07:58:23
 > PM
 >
 > To: <tom_coester@bstz.com>
 > cc: "Simon L. Bernstein \ (E-mail\)" <simon@adelphia.net>, "Caroline P.
 > Rogers" <caroline@cprogers.com>, "Eliot I. Bernstein"
 > <eliot.bernstein@verizon.net>
 > Subject: Crossbow
 >
 > Tom,
 >
 > It has been a short while, and I hope all is well with you and yours.
 > Moreover, specifically, I am writing because I have heard through the
 > grapevine that Crossbow has, again, made contact with you directly.
 >
 > As we have previously spoken and corresponded, I have requested that any
 > information pertaining to Iviewit intellectual property must be directed
 > through me, or Eliot Bernstein in my absence, and no other.
 >
 > Accordingly, please fill me in on the following:
 >
 > 1. Date of Crossbow contact with you and BSTZ;
 > 4/16 or 4/17
 > 2. Crossbow staffer contacting you and BSTZ;
 > Matt Shaw
 > 3. The time spent by you on this phone conversation;
 > I did not record the time less than 10 minutes
 > 4. The specifics of the discussion between you and the Crossbow staffer
 > pertaining to Iviewit intellectual property whether it be status of
 > patents
 > pending or questions pertaining to billings; and
 > Matt asked about Iviewit's AR balance. I told him I was not in a position
 > to discuss it with him. He told me that Eliot had told him there was a
 > 14k
 > balance. I neither confirmed nor denied this (though in point of fact it
 > is incorrect).
 > He asked if time was required to get up to speed when files are
 > transferred
 > in. I indicated that as a general matter there is time required to review
 > files transferred in and assimilate the information contained therein.
 > He inquired if I was opposed to working with crossbow in conjunction with
 > Iviewit. I told him I was not opposed to that but that Iviewit is my
 > client and I would require written instructions from Iviewit before I



Lorraine Christine Hoffman, Esq.
Assistant Staff Counsel
The Florida Bar
File No. 2003-51, 109(15C)

would

> release information to anyone at crossbow or take instruction from them.
> He advised that thought Iviewit and Crossbow may be best served working
> together on this.
> At some point he also mentioned that he had been having conversations with
> Eliot's other attorney whose name escapes me.

>
>

> 5. In what fashion do you plan on billing out your time on this
> unauthorized phone conversation by Iviewit, if at all, and should you bill
> out on this phone conversation, to what do the estimated professional fees
> amount.
> I had no intention of billing this phone call.

>

> I look forward to your earliest response, and I look forward to working
> with you.

>

> Best regards,

>

> P. Stephen Lamont
> Chief Executive Officer
> I View It Technologies, Inc.
> 10 Mela
> Rancho Palos Verdes, Cal. 90275
> Tel: (914) 217-0038
> email: pstephen.lamont@verizon.net

>

> CONFIDENTIALITY NOTICE

> This electronic message and its accompanying attachments (if any) contain
> information from the law firm of Blakely Sokoloff Taylor & Zafman LLP that
> is confidential and/or subject to attorney-client privilege. If you are
> not the intended recipient, be aware that any disclosure, copying,
> distribution, or use of the contents of this information is prohibited.

If

> you have received this message in error, please notify the above attorney
> by telephone immediately.

>

>

Incoming mail is certified Virus Free.
Checked by AVG anti-virus system (<http://www.grisoft.com>).
Version: 6.0.467 / Virus Database: 266 - Release Date: 4/1/2003



Lorraine Christine Hoffman, Esq.
Assistant Staff Counsel
The Florida Bar
File No. 2003-51, 109(15C)

The rationale for Crossbow Ventures being included in the rebuttal is because this would appear to be Mr. Wheeler's final attempt as the house of cards was crumbling around him to inflict damage to the Company, not only damage to cover-up his malfeasances but damages that again would lead to him and his referred investors and management referrals owning the Iviewit IP. Had his lawsuit been immediately effective and the Utley, RYJO, Hersh and Reale Involuntary Bankruptcy been successful what would have occurred in Bankruptcy is the following:

1. Crossbow would have claimed their secured notes as the largest creditor, secured under false pretense
2. Tiedemann/Prolow with faulty documents and questionable other elements would have stood next
3. Christopher Wheeler and Proskauer Rose would have had a lawsuit that prior to amendment appeared to double sue the company for a total of \$700,000 of erroneous billings
4. Utley, RYJO, Reale and Hersh would have had a claim for several hundred thousand dollars of felonious claims
5. The shareholders and inventors would have been annihilated

The only reason this whole Conspiracy failed is that Iviewit retained Caroline Prochotska Rogers, Esq. to replace the counsel secured by Ross Miller, who was acting as temporary CEO, a referral to the Company by Crossbow and Mr. Wheeler. Mr. Miller had secured counsel for actions that he did not even inform the Company had been taken against the Company. The Company found out that it was being sued by Wheeler and in an Involuntary BK by none other than Wayne Smith and David Colter of Warner Bros. Mr. Miller explained that he retained counsel and was handling the matters for the Company. Weeks before the Company was to appear in court in both counts, counsel quit due to bills that the Company was not aware of. Mr. Eliot Bernstein then contacted Caroline Prochotska Rogers, Esq. to help the Company in the final hours before court appearances. Like an angel to the Company, she quickly had Mr. Bernstein send all pertinent documents and evidence of the above allegations for her review. She had documents prepared to counter the Involuntary BK and once submitted Mr. Utley and his cohorts quickly abandoned their claims in the mounds of evidence submitted against them to the court. In the Proskauer Rose case she hired attorney Steven Selz, Esq. to handle the case and after submitting volumes of evidence to Mr. Selz he did a formidable job of filing the attached counter claim against Proskauer et. al. and invoked claims of Civil Conspiracy amongst others. The fact that it had taken so long to file due to the volumes of evidence that had to be reviewed before he would file such charges, Judge Labarga felt that it had come too late to be heard in this particular venue, the Company currently is analyzing a number of Federal venues to make such claims against Proskauer et.al..



Lorraine Christine Hoffman, Esq.
Assistant Staff Counsel
The Florida Bar
File No. 2003-51, 109(15C)

XVII. Credibility of Respondents witnesses in his response to the Bar of Florida.

1. Brian G. Utley – It is apparent from Mr. Utley’s deception of his past employment and his perjured statements in business plans and under deposition that very little of what he says is credible.
2. Kenneth Rubenstein – Mr. Rubenstein statements are fraught with perjury, he has tremendous conflicts of interest with company, and he is in absolute denial of what occurred and his involvement. His statements cannot be trusted.
3. Gerald Lewin – He is a 20 year friend of Albert Gortz, the initial Proskauer Rose attorney that brought in Christopher Wheeler and at one point he was found not disclosing that he represented a client, in fact had taken them public, that ended up trying to steal Iviewit’s processes, a one Visual Data. This evidence came to the Company from Goldman Sachs representatives who were researching Mr. Lewin’s referral after it had been discovered that they were using the Iviewit processes. Visual Data was found using, under NDA taken by Wheeler Iviewit’s processes as their own on public display systems. Mr. Wheeler was brought in to investigate the claim and drafted a letter for Mr. Lewin’s entire firm to sign regarding the Conflict and Visual Data was summoned by Mr. Wheeler to cease and desist using the Iviewit processes on public displays. What Mr. Wheeler failed to disclose to the Company at the time was his own Conflict in handling the matter, as Visual Data was also a client of Proskauer Rose. Also, a conflict existed in his taking the investigation of Mr. Lewin and his firm Goldstein Lewin with the 20 year relationship between Gortz and Lewin. This matters documents have been submitted as Exhibit I.

We submit the following letter to Mr. Wheeler in addition for this case:



Lorraine Christine Hoffman, Esq.
Assistant Staff Counsel
The Florida Bar
File No. 2003-51, 109(15C)



GOLDSTEIN LEWIN & CO.
Certified Public Accountants

June 24, 1999

Chris Wheeler
Proskauer Rose LLP
2255 Glades Road, Suite 340W
Boca Raton, FL 33431

Dear Chris:

Enclosed are the remaining executed employee affidavits for Goldstein Lewin & Co. regarding the iVIEW, Inc. conflict of interest matter. At this time, all employees have submitted an affidavit.

Thank you for your assistance.

Sincerely,

GOLDSTEIN LEWIN & CO.
Certified Public Accountants

Gerald R. Lewin, CPA

GRL/bjw
Enclosures (11)

c: Eliot Bernstein

f:\data\99\40875\finlaffids.doc.

1900 N.W. Corporate Blvd.
East Building Suite 300
Boca Raton, Florida 33431
(561) 994-5050

Broward (954) 429-8555
Dade (305) 944-3582
Palm Beach (561) 737-0309
FAX (561) 241-0071

Fort Lauderdale Office
4850 West Prospect Road
Fort Lauderdale, FL 33309
(Reply to Boca Address)



Lorraine Christine Hoffman, Esq.
Assistant Staff Counsel
The Florida Bar
File No. 2003-51, 109(15C)

Page 1 of 1

Eliot I Bernstein

Subject: FW: iviewit

-----Original Message-----

From: eib [mailto:alps@netline.net]
Sent: Thursday, June 03, 1999 4:39 AM
To: Simon L. Bernstein (E-mail); Christopher C. Wheeler (E-mail)
Subject: iviewit

Chris,

1. Please send a disclosure of patent agreement over to Richard Rosman prepared for Hassan Miah. They will also be sending a technician so send a second blank copy with a place for name and company.
2. Send a confidentiality to Richard Rosman for Richard Rosman
3. Send a confidentiality to Richard for Kevin O'Donnell President of O'Donnell & Associates
4. Confidentiality for Techie

We are trying to have the meeting ASAP, so please send this morning if possible, I will have Richard standing by at 9:am California time. Hope all is going well and you are feeling good.

Eliot

Also, Jerry Lewin called re: the letter you will be drafting for his employee pool. I am concerned that we cover any past employees because one of the girls that was working at our house from his office he fired 6.1.99 for lack of performance. Her name was Michele ?. I would suggest a list of all employees Jerry has had for the last 18 months, he could not recall how many exactly had been dismissed. We also looked at the stock performance for Visual Data together and it was apparent that stock increases have occurred since our meeting with significant increases around the time when I gave Jerry's employees the passwords for our site. Jerry suggested very strong language in regards to stock purchases by emps or their families.

Thanks,

Eliot

From Mr. Lewin's deposition we will take samples of his inconsistencies and although he was Iviewit's accountant, Board member, shareholder and referral source to Proskauer Rose, he has trouble recollecting many key events.

Here is a true statement that emphasizes that Iviewit did not get to Chris Wheeler and Proskauer Rose for corporate work as Wheeler's deposition would have you think, but to get patents for novel concepts:



Lorraine Christine Hoffman, Esq.
Assistant Staff Counsel
The Florida Bar
File No. 2003-51, 109(15C)

14 A. Yes. I knew Sy Bernstein who was a
15 neighbor of mine. Sy approached me and he said his
16 son has developed some process for the Internet that
17 could possibly be patented. And he asked me whether
18 I could help them - introduce him to some - to
19 attorneys and could possibly get involved myself from
20 an accounting and a business point of view.

Page 7 – Lewin Deposition

Further from his deposition we see he cannot remember key times:

9

1 Q. Did you become a board member sometime
2 thereafter?
3 A. Yes.
4 Q. Okay. Do you remember when that was?
5 A. No.
6 Q. Do you remember what year it was?
7 A. No.
8 Q. Who asked you to be a board member?
9 A. Sy Bernstein and Eliot Bernstein.

Further we can see the coaching of the Proskauer attorney as Mr. Lewin answers questions:



Lorraine Christine Hoffman, Esq.
Assistant Staff Counsel
The Florida Bar
File No. 2003-51, 109(15C)

10 Q. (By Mr. Prusaski) What was Iviewit's
11 intent in hiring Proskauer?

12 A. Prepare the legal work and introduce them
13 to possible investors and perhaps clients of theirs
14 who could use the technology that Eliot developed
15 that Iviewit owned at that time.

16 Q. Do you remember the attorneys from
17 Proskauer who did work for Iviewit?

18 A. Yes. It was Chris Wheeler was the head.
19 And I'm trying to remember. There was a --

20 Q. Does Rocky Thompson sound familiar?

21 A. Rocky Thompson. That's the one. Yes,
22 those were the two.

10 Q. (By Mr. Prusaski) What was Iviewit's
11 intent in hiring Proskauer?

12 A. Prepare the legal work and introduce them
13 to possible investors and perhaps clients of theirs
14 who could use the technology that Eliot developed
15 that Iviewit owned at that time.

16 Q. Do you remember the attorneys from
17 Proskauer who did work for Iviewit?

18 A. Yes. It was Chris Wheeler was the head.
19 And I'm trying to remember. There was a --

20 Q. Does Rocky Thompson sound familiar?

21 A. Rocky Thompson. That's the one. Yes,
22 those were the two.

Page 10 – Lewin deposition



Lorraine Christine Hoffman, Esq.
Assistant Staff Counsel
The Florida Bar
File No. 2003-51, 109(15C)

Now this next exchange which also appears to be coached by the Proskauer attorney is remarkable in that most of the statements are false:

The statement posed regarding Foley and Lardner being the patent counsel out of New York is incorrect in that Foley and Lardner is out of Wisconsin and they were not even remotely at the time Mr. Lewin is referencing. What Proskauer's attorney is hoping not to hear is the name Kenneth Rubenstein and although Mr. Lewin cites a Proskauer patent attorney being brought in as a **consultant**, Mr. Prusaski tries to lead him away.

23 Q. Do you know if any other law firms were
24 used by Iviewit besides Proskauer Rose?
25 A. Yes, there was a law firm used in New

The



Lorraine Christine Hoffman, Esq.
Assistant Staff Counsel
The Florida Bar
File No. 2003-51, 109(15C)

13

1 York to - I think to patent all of the technology
2 that Elicot supposedly developed:

3 Q. Was that Foley & Lardner?

4 A. Yes.

5 Q. Did Proskauer do patent work for Iviewit?

6 A. I'm trying to remember. They did consult
7 an attorney in New York, one of Proskauer's attorneys
8 in New York. I don't recall his name. And I do have
9 to tell you I'm not very good with names.

10 Q. Okay.

11 A. Okay.

12 Q. That's fine. And I appreciate your
13 honesty. We don't want you to guess.

14 A. No.

15 Q. If you don't remember, simply say you
16 don't remember.

17 A. No, that is not my strength.

18 There was an attorney in New York who -
19 who was consulted. I don't recall him doing any
20 actual work on the patent, but I know he was
21 consulted about the patents.

22 Q. Is he the one who referred Foley &
23 Lardner?

24 A. I think so, yes.

25 Q. When did you stop becoming a board member

KEN SCHANZER & ASSOCIATES, INC. (954) 922-2660

The final statement that the New York attorney recommended Foley and Lardner is also incorrect, Mr. Wheeler and Mr. Utley recommended Foley and Lardner.



Lorraine Christine Hoffman, Esq.
Assistant Staff Counsel
The Florida Bar
File No. 2003-51, 109(15C)

This next exchange shows that we were unhappy with Kenneth Rubenstein's overseeing the patents and this is a true statement from Mr. Lewin:

17 Q. Do you recall ever having discussions or
18 hearing discussions among principals of Iviewit that
19 they weren't happy with Proskauer's services?

20 A. The only discussions related was -- Was
21 it Ken Attelman, the one that -- Who was --

22 Q. I can't - I can't answer that.

23 A. You can't answer. There was an attorney
24 in New York that was supposed to oversee the - or
25 involved somehow with the patent. And the

Page 16- Lewin deposition

17

1 discussions were related to was he doing a good
2 enough job overseeing Foley's firm, you know,
3 handling the patent or he supposed --

4 Q. Is this Ken Rubenstein?

5 A. Ken Rubenstein. That's the guy, yes.
6 There were discussions related to Ken Rubenstein and
7 the patents. That was it.

8 Q. Who had those discussions? Who were the
9 people involved?

10 A. Sy and Eliot generally.

11 Q. Was Ken Rubenstein supposed to oversee
12 Foley & Lardner?

This next exchange shows that concerns over the patents were exposed over and over again and that Mr. Lewin, like Mr. Wheeler did nothing to investigate, instead they



Lorraine Christine Hoffman, Esq.
Assistant Staff Counsel
The Florida Bar
File No. 2003-51, 109(15C)

covered it up. Mr. Lewin claims that Patent Theft to a company that he is an accountant for and has fiduciary responsibilities is simply "general complaining."

18 A. ~~Well, at one time, Eliot was saying~~
19 ~~that...that somebody there might have been trying to~~
20 ~~steal his patents and wasn't filing them properly.~~
21 ~~Just general complaining.~~
22 Q. Is Eliot a complainer?
23 MR. SELZ: Objection to the form of the
24 question.
25 Q. (By Mr. Prusaski) You can answer. You

In this next statement we find that Mr. Lewin is trying to erase his memories of the events?

4 Q. Are you aware of any instances where
5 Eliot or Sy told Brian not to pay Proskauer because
6 he had a actual problem with the bills?
7 A. You know, I'm trying to recall events of
8 my memory that I'm trying to erase. You know, it's
9 hard sometimes to distinguish general complaining
10 from specific - from specific telling somebody not to
11 pay.

In the next exchange Lewin lies about not knowing Raymond Joao and upon request we the Company will submit to the Bar of Florida hosts of correspondences between Mr. Lewin and Mr. Joao. Again, he mistakes Joao/Rubenstein for Foley and Lardner.



Lorraine Christine Hoffman, Esq.
Assistant Staff Counsel
The Florida Bar
File No. 2003-51, 109(15C)

39

1 Q. Let me go through my notes. I might be
2 done.

3 A. Okay.

4 Q. A few points: Do you recall a patent
5 attorney who did work for Iviewit named Joao -
6 J-o-a-o - which I believe is a Brazilian or a
7 Portuguese name?

8 A. No.

9 Q. Do you remember why Foley & Lardner no
10 longer did work for Iviewit - patent work after a
11 certain time?

12 A. Eliot and Sy, and I'm not sure whether
13 Brian was involved in that decision, might have been
14 they decided they wanted to switch it over to another
15 firm. And there were some people that Brian Utley
16 knew. There was a law firm that Brian Utley knew. I
17 don't recall their name. But it was switched over to
18 them.

19 Now, Foley & Lardner, were they
20 originally the patent attorneys?

21 Q. I believe so.

22 A. Okay. Who were -- I forgot the name of
23 the people that it was switched over to. There was a
24 law firm that Brian was familiar with that
25 specialized in patent work,

KEN SCHANZER & ASSOCIATES, INC. (954) 922-2660



Lorraine Christine Hoffman, Esq.
Assistant Staff Counsel
The Florida Bar
File No. 2003-51, 109(15C)

40

1 Q. Are you aware of any law firms besides
2 Proskauer that stopped doing work for Iviewit because
3 of bill issues?

4 A. Yes.

5 Q. Who are they?

6 A. I would say probably all the law firms
7 they did that with.

8 Q. Eventually stopped --

9 A. Yes.

10 Q. -- working for Iviewit --

11 A. Yes.

12 Q. -- because of non-payment?

13 A. Yes.

14 Q. Do you know if there are any reasonable
15 defenses that Iviewit had to actually paying those
16 bills?

17 MR. SELZ: Objection to the form of the
18 question.

19 A. I --

20 Q. Other than not having money, did Iviewit
21 have any reason not to pay those bills?

22 MR. SELZ: Same objection. And also to
23 relevancy.

24 Q. (By Mr. Prusaski) You can answer the
25 question.

KEN SCHANZER & ASSOCIATES, INC. (954) 922-2660



Lorraine Christine Hoffman, Esq.
Assistant Staff Counsel
The Florida Bar
File No. 2003-51, 109(15C)

41

1 A. They at the end were not happy with the
2 patent work that was done at the law firm. If that's
3 the name, Foley & Lardner. I'm not sure. You know,
4 I don't recall names. But the original patent law
5 firm that did the patent work, they were not happy
6 with. And whether they stopped payments or didn't
7 pay them or finish paying them, I'm not aware.

8 Q. When you say, you're referring to Eliot
9 and Sy?

10 A. Yes.

11 Q. Anyone else?

12 A. I would say mainly Eliot and Sy.

13 Q. Was Brian Utley not happy with Foley &
14 Lardner's work?

15 A. I'm not sure. It was mostly Eliot, not
16 Sy.

17 Q. Did you ever hear them complain?

18 A. Brian, no. I did not hear Brian
19 complain.

20 Q. I'm sorry. What were you saying, this
21 was mostly Eliot, not Sy?

22 A. Mostly Eliot, not Sy, yes. Because I
23 don't know -- You know, Sy didn't understand the
24 technology and patent either. It was really Eliot,
25 you know, that understood that.

KEN SCHANZER & ASSOCIATES, INC. (954) 922-2660



Lorraine Christine Hoffman, Esq.
Assistant Staff Counsel
The Florida Bar
File No. 2003-51, 109(15C)

Here Lewin forgets the Conflict of Interest caused by his firm that led to every single employee having a Conflict letter signed including himself, and a severe Conflict with one his biggest clients and Iviewit.



Lorraine Christine Hoffman, Esq.
Assistant Staff Counsel
The Florida Bar
File No. 2003-51, 109(15C)

46

1 questions on.

2 You had indicated that at one point in
3 time, your CPA firm - and when I mean yours, I mean
4 Goldstein, et al. - had provided CPA services to the
5 Iviewit companies; is that correct?

6 A. That's correct.

7 Q. Okay. Did Mr. Bernstein ever complain to
8 you about the services your CPA company provided to
9 Iviewit?

10 A. No.

11 Q. How about with regard to the - what you
12 testified to earlier, that is, that Iviewit and
13 specifically Eliot Bernstein and Sy Bernstein, were
14 concerned about about having a nationally prominent
15 law firm handling the matters for the Iviewit
16 companies?

17 A. Yes.

18 Q. Were you privy to any of the discussions
19 between Proskauer Rose's representatives and Messers.
20 Bernstein and the board members on exactly what the
21 scope of representation was going to be for Proskauer
22 Rose?

23 MR. PRUSASKI: Object to the form.

24 A. When they were originally engaged, I was
25 not a board member yet.

KEN SCHANZER & ASSOCIATES, INC. (954) 922-2660

Here we find that Proskauer Rose was actually doing patent work in that they formed Company's and strategy's to protect the patents which have not been very protective:



Lorraine Christine Hoffman, Esq.
Assistant Staff Counsel
The Florida Bar
File No. 2003-51, 109(15C)

12 Do you recall why there were upwards of
13 eight entities formed?

14 MR. PRUSASKI: Objection. Assumes facts
15 not in evidence. Go ahead.

16 A. Yes. Yes. Some of the entities were
17 formed to protect - so we could put the patents in
18 them. Some of the entities were formed to be a
19 management company. Some of the entities were
20 formed --

Here Mr. Lewin appears aware that Mr. Utley had improperly prepared patents:

11 A. Other than? I mean, there were many
12 dispute -- You know, when you have a board of
13 directors and you have management, there's many
14 disagreements on how to conduct company policy.

15 Q. Okay.

16 A. I mean, there were hundreds of them.

17 Q. Were there any disagreements concerning
18 the manner in which the patents had been filed or the
19 names under which the patents had been filed?

20 A. I don't recall on the names. I recall
21 there were maybe disagreements of - you know, which I
22 don't understand - I do not understand patents - of
23 whether papers were prepared this way or that way or
24 properly or improperly or -- You know, maybe those
25 were discussions.

In one last instance of Lewin malfeasance, we request the Florida Bar contact inventor Zakirul Shirajee regarding the following. Mr. Lewin was also found to have placed a live



Lorraine Christine Hoffman, Esq.
Assistant Staff Counsel
The Florida Bar
File No. 2003-51, 109(15C)

cell phone in a conference room at Proskauer Rose where highly confidential patent disclosures were taking place that he was not invited to. He was asked to step out of the room when patent disclosures began with patent attorneys Rubenstein and Joao, the inventors (Eliot Bernstein and Zakirul Shirajee) heard a cell phone with people saying Gerry we can't hear, we can't hear. After searching the room, Eliot and Zakirul found Mr. Lewin's cell phone in his jacket pocket with an open connection, upon discovery they left the conference room and went into the hall of Proskauer's office, whereby they were confronted by Donald Rocky Thompson, who claimed he and Mr. Wheeler would begin an investigation and find out who was on the call. He then arranged for a new conference room for the patent disclosures to take place in.

Finally, Mr. Lewin's deposition is fraught with misstatements of the events and the people involved, his entire lack of recollection on the patent attorneys leads him to consistently be led by Mr. Pruzaski to name the wrong firms. These misstatements and his erasing his memory, leave his deposition statements less than credible.

4. Raymond Hersh – Iviewit had no representatives available at this deposition to ask questions. Although Proskauer was contacted during the deposition by attorney Steven Selz and asked to postpone since his car was broken down, Proskauer refused and continued. Iviewit therefore finds this deposition to be one-sided and coached, and Mr. Hersh also has a personal relationship with Mr. Wheeler. Mr. Hersh was brought to the Company by Maurice Buchsbaum, a Wheeler referral and Mr. Wheeler.

5. Eliot Bernstein – Mr. Bernstein objects to his statements being used in Wheeler's response, it is questionable how without a requested read of the transcript by Mr. Bernstein as is evidenced on the last page of his deposition, Proskauer has obtained and disseminated his testimony. The Company's attorney Steven Selz was also not notified that the deposition was being transcribed and disseminated. We find this unconscionable by a law firm that is fully aware of the rules and regulations of depositions. In light of the entire body of crimes we find this to be small but telling.

It may in light of all these events and the death threat levied by Mr. Utley on behalf of himself and Mr. Wheeler against Mr. Bernstein, become apparent why Mr. Bernstein has feared for his life as well as the lives of his wife and children. Several months prior to the counter complaint being filed, Mr. Bernstein had contacted Harry Moatz of the patent office, the FBI and the Rancho Palos Verdes police regarding the incidents relating to these matters and the threats. It was then decided by Caroline Prochotska Rogers, Esq. that the best course of action would be to prepare a case as quickly as possible to tie all of these issues into a coherent picture of what was transpiring. Since corporate records and attorney files have been destroyed, computer files have been formatted, computers were



Lorraine Christine Hoffman, Esq.
Assistant Staff Counsel
The Florida Bar
File No. 2003-51, 109(15C)

stolen, and the Company domain was locked and passwords not transferred it has been a monumental job to piece together from various other members of the Board, Investors, employees not involved in the conspiracy relevant facts and documents to support all of these allegations.

Enron/Arthur Andersen certainly supports the case that even well respected businessmen, philanthropists and trusted advisors when motivated by greed will act in unethical and malicious ways. Certainly by the time Chris Wheeler had learned from Ken Rubenstein, Real 3D engineers and Hassan Miah that the technologies were compared to the Holy Grail of imaging and video, well I am sure one can see the motive of greed, especially when Real 3D had valued each of the technologies to be worth billions of dollars annually as the products effect almost all forms of imaging and video. The deposition extracts regarding Mr. Bernstein's deposition and the uncertainty of certain individuals in the conspiracy result from Mr. Bernstein's unwillingness to accuse individuals without evidence or a chance to question under oath those individuals that may be involved. We urge the Bar to question each and every individual referred by Mr. Wheeler to Iviewit to the extent of their involvement in any wrongdoings. It is of interest to note that although the conspiracy does involve many people all roads in the conspiracy lead to Mr. Wheeler, his referrals or their friends. Out of the countless other investors, employees involved with the Company not a single instance of malfeasance is leveled against any of the following well respected businessmen, lawyers, law firms and philanthropists not introduced by Mr. Wheeler including but not limited to;

Wayne Huizenga and Wayne Huizenga Jr. (Seed investors), Alan Epstein, Esq., Kenneth Anderson, CPA, Donald Kane (ex-managing partner of Goldman Sachs), James Osterling, James Armstrong, Blakely Sokoloff Zafman and Taylor (patent law firm), Irell and Manella (law firm), Armstrong Hirsch Jackoway Tyerman & Wertheimer (Law Firm), Ellen DeGenres (Shareholder), Alan Young (Shareholder), Allan Shapiro (Atlas Entertainment – Shareholder), Mitchell Welsch (UBS Paine Webber), Jeffrey Friedstein (Goldman Sachs, shareholder) and many more esteemed individuals that the bar can collaborate Mr. Bernstein's deposition testimony and I View It's conspiracy.

The deposition extracts from Mr. Bernstein's deposition in no way support the lack of a conspiracy and the fear one fears of exposing a conspiracy that involves people who are willing to fraud the US patent office, steal patents, destroy documents and lie under deposition to cover their tracks.

In regard to the destruction of documents extract it is equally telling that PR was misleading the Florida Bar in the meaning of destruction of documents, in his deposition Mr. Bernstein alleges that documents that were not put forth under Judge Jorge Labarga's order to have all documents available were not in the set of documents put forth by PR and thus were missing and therefore in the Company's and Mr. Bernstein's opinion therefore destroyed. Many folders, of which we will submit taped review and pictures to



Lorraine Christine Hoffman, Esq.
Assistant Staff Counsel
The Florida Bar
File No. 2003-51, 109(15C)

illustrate, and refer the Bar to attorney Steve Selz who also noticed a mass of folders missing all documents, certainly pointed to the destruction of the documents that were supposed to be in those folders. In Mr. Bernstein's deposition you will see that Mr. Pruzaski claims that they may be on shelves and not procured for review and when Mr. Bernstein states that the documents were court ordered to be there in entirety he redacts his statement that there is anything on the shelves and thus Mr. Bernstein claims that the documents were therefore destroyed. In an attempt to badger Mr. Bernstein in his deposition Mr. Pruzaski advises Mr. Bernstein to get a dictionary and look up the word destroy which he believes does not include the term missing in the closing sentences of his deposition.



Lorraine Christine Hoffman, Esq.
Assistant Staff Counsel
The Florida Bar
File No. 2003-51, 109(15C)

238

1 Q. Destroying documents by a law firm isn't very key
2 to you?

3 A. I've notified my counsel that that occurred long
4 ago, so he might have overlooked it in filing the claim to
5 get it on based on the evidence --

6 Q. Okay. So you're still sticking to your story that
7 Proskauer destroyed documents?

8 A. I'm -- because they're missing, in my
9 interpretation --

10 Q. Because he's missing them -- you let your attorney
11 know, but you didn't put it in the counterclaim?

12 A. Well, he has a lot of it, you know. Yes, I would
13 say --

14 Q. So you are still sticking to your story that
15 Proskauer destroyed documents --

16 A. In my interpretation --

17 Q. -- but you have no personal knowledge of whether
18 they did?

19 A. -- of the word destruction, because they are not
20 present in any records that the company can now get, yes,
21 they have been, since Mr. Wheeler was keeping records of
22 them.

23 Q. So destroyed means missing to you?

24 A. Yes.

25 MR. PRUSASKI: Right. Why don't you go buy a

KEN SCHANZER & ASSOCIATES
(954) 922-2660



Lorraine Christine Hoffman, Esq.
Assistant Staff Counsel
The Florida Bar
File No. 2003-51, 109(15C)

1 dictionary? There's a Barnes & Noble down the
2 street.

3 I have no further questions. Thank you.

4 THE WITNESS: Okay.

5 Does he want to read or waive?

6 MR. SELZ: He'll read. Hold the
7 transcript.

8 (Thereupon, the deposition was concluded
9 at 4:29 p.m.)

Never has Eliot Bernstein Read this document
prior to Proskauer using it in their rebuttal???

11 AND FURTHER THE DEPONENT SAITH NOT

14 DEPONENT

16 STATE OF FLORIDA

17 COUNTY OF BROWARD

19 SUBSCRIBED AND SWORN to before
20 me this _____ day of _____, 2003, at Broward
21 County, Florida.

24 _____
Notary Public, State of Florida

KEN SCHANZER & ASSOCIATES
(954) 922-2660



Lorraine Christine Hoffman, Esq.
Assistant Staff Counsel
The Florida Bar
File No. 2003-51, 109(15C)

Mr. Bernstein has provided here the dictionary definition for review from the Oxford.com library, the highlighted and bolded definitions are what Mr. Bernstein referred to in light of the court order to have ALL documents available for review.

B. destroy

/dɪˈstrɔɪ/ *verb* **1** pull or break down; make useless. **2 end existence of.** **3** kill. **4** ruin financially. **5** defeat.

·**1**break down, burst, *colloquial* bust, crush, decimate, demolish, devastate, devour, dismantle, flatten, fragment, knock down, lay waste, level, nullify, pull down, *colloquial* pulverize, raze, ruin, sabotage, sack, scuttle, shatter, smash, undo, uproot, **wipe out**, wreck, write off. **2abolish**, annihilate, cancel, **dispose of**, *colloquial do away with*, **eliminate**, end, eradicate, **erase**, exterminate, extinguish, extirpate, finish off, **get rid of**, liquidate, put an end to, **put out of existence**, root out, stamp out, vaporize, **wipe out**.

Etymology: Middle English, from Old French *destruire*, from (assumed) Vulgar Latin *destrugere*, alteration of Latin *destruere*, from *de-* + *struere* to build - *Date:* 13th century

And to clarify

Lastly, as Barnes & Noble's is a convenient venue for information, the Company opts for a more cost effective form of information gathering and references the URL at <http://www.onelook.com> and selects the Webster's 1828 dictionary's definition of "destroy" finding:

DESTROY, v.t. [L. To pile, to build.]

1. To demolish; to pull down; to separate the parts of an edifice, the union of which is necessary to constitute the thing; as, to destroy a house or temple; to destroy a fortification.
2. To ruin; to annihilate a thing by demolishing or by burning; as, to destroy a city.
3. To ruin; to bring to naught; to annihilate; as, to destroy a theory or scheme; to destroy a government; to destroy influence.



Lorraine Christine Hoffman, Esq.
Assistant Staff Counsel
The Florida Bar
File No. 2003-51, 109(15C)

4. To lay waste; to make desolate.
5. Go up against this land, and destroy it. Is. 36
6. To kill; to slay; to extirpate; applied to men or other animals.
7. Ye shall destroy all this people. Num. 32.
8. All the wicked will he destroy. Ps. 145.
9. To take away ; to cause to cease; to put an end to; as, pain destroys happiness.
10. That the body of sin might be destroyed. Rom 6.
11. To kill; to eat; to devour; to consume. Birds destroy insects. Hawks destroy chickens.
12. In general, to put an end to; to annihilate a thing or the form in which it exists. An army is destroyed by slaughter, capture or dispersion; a forest, by the ax, or by fire; towns, by fire or inundation, &c.
13. In chimistry, to resolve a body into its parts or elements.

And its synonym, “suppress” finding:

SUPPRESS', v.t. [L. suppressus, supprimo; sub and premo, to press.]

1. To overpower and crush; to subdue; to destroy; as, to suppress a rebellion; to suppress a mutiny or riot; to suppress opposition.
2. Every rebellion when it is suppressed, makes the subject weaker, and the government stronger.



Lorraine Christine Hoffman, Esq.
Assistant Staff Counsel
The Florida Bar
File No. 2003-51, 109(15C)

3. To keep in; to restrain from utterance or vent; as, to suppress the voice; to suppress sighs.
4. To retain without disclosure; to conceal; not to tell or reveal; as, to suppress evidence.
5. She suppresses the name, and this keeps him in a pleasing suspense.
6. To retain without communication or making public; as, to suppress a letter; to suppress a manuscript.
7. To stifle; to stop; to hinder from circulation; as, to suppress a report.
8. To stop; to restrain; to obstruct from discharges; as, to suppress a diarrhea, a hemorrhage and the like.

Consequently, the Company maintains that if the Court ordered Respondent to present ALL records for viewing and copying, and should it be apparent to Mr. Selz and Mr. Bernstein that known records are not included, then it would follow that said records are “missing”, and if such “missing” records are not shelved as Respondent’s counsel maintains, then such “missing records” have been “taken away or destroyed” and still further if “taken away or destroyed” then said records were “retained without disclosure; to conceal; not tell or reveal; as, to suppress evidence,” all in violation of the Court order to present ALL records, and in support of the Company’s Complaint.

These are a few definitions that were referred to when Mr. Bernstein stated that the missing documents were destroyed and perhaps this definition will help Proskauer Rose attorney’s Mssrs. Triggs and Pruzaski in future depositions where their firm fails to procure all records demanded in a court order and they badger deposeses from sheer ignorance of the English language.

Thus based on a proper understanding of the English language and the word destroy, there are volumes of empty folders with the entire contents missing that would constitute volumes of evidence (more than a shred or perhaps a lot of shredding) that evidence that documents have been “destroyed”. The lack of witness to the destruction of the documents is irrelevant in light of the fact that they are missing.

It is apparent in the Counter-Claim filed that Mr. Bernstein is not the person who has charged Mssrs; Wheeler, Mutely, Rubenstein, Joao and Dick with a conspiracy but attorney Steve Selz, Esq. and Caroline Rogers, Esq. who helped prepare the claim who



Lorraine Christine Hoffman, Esq.
Assistant Staff Counsel
The Florida Bar
File No. 2003-51, 109(15C)

have levied these charges against these conspirators. Attacking Mr. Bernstein is a mere attempt to hide from the fact that competent and licensed attorneys who have reviewed the case and the evidence have chosen to file these claims. Hosts of witnesses, employees and investors in the Company will also support various allegations levied and thus this defense of PR in attacking Mr. Bernstein is more harassment of Mr. Bernstein in an attempt to steal his and others inventions, it certainly does not negate the facts that the patents are in danger, the companies are danger, Mr. Bernstein's life is in danger from Mr. Wheeler and his friends, and that immediate investigatory bodies should be called in to question the perpetrators of these crimes and seek to protect the inventors, shareholders, employees and all the other good people involved with I View It from a few rotten and "evil" apples.

6. Simon Bernstein – Although he is mentioned in the response his deposition was excluded by Proskauer Rose? We suggest that the Florida Bar request this deposition.
7. William Kasser – Deposition was excluded in Proskauer's response we request that the Bar of Florida request this deposition.

Finally, Iviewit requests the Bar of Florida to find one person not related to Christopher Wheeler in one way or another to support his claims. We ask you to call all the other members of the Board, investors, inventors, employees, lawyers and law firms that we have submitted as witnesses that will collaborate Mr. Wheeler's accounts, what you will find is that all will verify the accounts herein as truthful.

8. Conclusion

What we ask the Florida Bar for help with is championing the causes against Mr. Wheeler who is the main protagonist of all these allegations immediately as the damages he has inflicted currently may jeopardize the entire patent portfolio of Iviewit and ruin 20 years of revenue the Company and its shareholders rightfully deserve. The Company stands on the eve of Bankruptcy from these malfeasances and is in critical need of help to fix the patents. Mr. Wheeler has damaged the Company so severely that it may not be able to pay for further legal counsel to fight these crimes and thus is seeking as much state and federal help as it can secure. The crimes are certainly worthy of Federal and State prosecution and the Company is in need of dire help in protecting the patents and thus invokes the Florida Bar to do what it can in contacting the US Patent Office and other related commerce departments of the crimes, which have been perpetrated not only against Iviewit but the US Patent office, as alleged herein in this rebuttal. It would also appear that these crimes, such as submitting fraudulent patent documents, etc. where



Lorraine Christine Hoffman, Esq.
Assistant Staff Counsel
The Florida Bar
File No. 2003-51, 109(15C)

committed through the US Postal Service and have certainly denied the IRS of revenues as well.

We ask the Bar of Florida to have the almost \$1,000,000 of legal fees either spent with Proskauer Rose or its referrals Meltzer Lippe Goldstein and Schlissel and Foley and Lardner be refunded, as well as, the amounts spent with Blakely Sokoloff Zafman and Taylor to fix the patents and finally the estimated \$250,000 by Greenberg Truarig to completely try and fix and complete the patents be paid for by Mr. Wheeler and his partners involved at Proskauer Rose LLP.

The Company respectfully requests the Bar to invite other relevant Federal Investigator Departments including but not limited to the following to help insure that these crimes are met swiftly and further damages are prevented:

Harry Moatz
Director, Office of Enrollment and Discipline
United States Patent and Trademark Office
Box OED, Post Office Box 2327
Arlington, Va. 22202-2327

The FBI

The Department of Justice

The National Intellectual Property Law Enforcement Coordination Council

The US Customs Intellectual Property Investigatory Committee

The Internal Revenue Service

The US Postal fraud department

Constitution of the United States of America - Section 8

The Congress shall have Power: To promote the Progress of Science and useful Arts, by securing for limited Times to Authors and Inventors the exclusive Right to their respective Writings and Discoveries



Lorraine Christine Hoffman, Esq.
Assistant Staff Counsel
The Florida Bar
File No. 2003-51, 109(15C)

With best regards,

Eliot I. Bernstein
Iviewit Holdings, Inc.



Lorraine Christine Hoffman, Esq.
 Assistant Staff Counsel
 The Florida Bar
 File No. 2003-51, 109(15C)

Exhibit A – Counter Claim – Including but not limited to Civil Conspiracy

IN THE CIRCUIT COURT OF THE
 15TH JUDICIAL CIRCUIT IN AND
 FOR PALM BEACH COUNTY,
 FLORIDA

PROSKAUER ROSE L.L.P,
 a New York limited partnership,

CA 01-04671 AB

Plaintiff,

v.

IVIEWIT.COM, INC., a Delaware
 corporation, IVIEWIT HOLDINGS,
 INC., a Delaware corporation, and
 IVIEWIT TECHNOLOGIES, INC.,
 a Delaware corporation.

COPY / ORIGINAL
 RECEIVED FOR FILING

JAN 28 2003

DOROTHY H. WILKEN
 CLERK OF CIRCUIT COURT
 CIRCUIT CIVIL DIVISION

Defendants.

**DEFENDANTS MOTION FOR LEAVE TO AMEND TO ASSERT
 COUNTERCLAIM FOR DAMAGES**

Defendants, IVIEWIT.COM, INC., IVIEWIT HOLDINGS,
 INC. and IVIEWIT TECHNOLOGIES, INC., by and through their undersigned
 counsel, hereby move this Court for Leave to Amend their Answer so as to assert a
 counterclaim in this matter pursuant to Rule 1.170(f) of the Florida Rules of Civil
 Procedure and as grounds therefore would state as follows:

1. That the Defendants move to amend their answer in this matter so as to include a counterclaim in this matter, which by its nature appears to be a compulsory counterclaim to the extent that the issues arise out of the same nexus of events, as

justice requires that the counterclaim be tried at the same time as the complaint and answer so that all pending issues between the parties may be adjudicated in this action.

2. That as a result of fact that additional evidence in support of the Defendants' counterclaims is found in the Plaintiff's own files and records, the Plaintiff will not be prejudiced by the amendment of the Defendants' answer in this matter, nor will this matter be delayed as to the trial of same.

3. Defendants have attached hereto a copy of the proposed counterclaim.

WHEREFORE the Defendants, move this Honorable Court for the entry of an order permitting the Defendants to amend their answer in this matter.

I HEREBY CERTIFY that a true and correct copy of the foregoing has been provided by U.S. Mail and fax transmission this 28th day of January, 2003 to: Christopher W. Prusaski, Esq., Proskauer Rose, LLP, 2255 Glades Road, Suite 340 W, Boca Raton, FL 33431.

SELZ & MUVDI SELZ, P.A.
214 Brazilian Avenue, Suite 220
Palm Beach, FL 33480
Tel: (561) 820-9409
Fax: (561) 833-9715

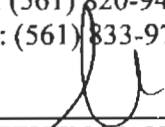
By: 
STEVEN M. SELZ
FBN: 777420



Lorraine Christine Hoffman, Esq.
Assistant Staff Counsel
The Florida Bar
File No. 2003-51, 109(15C)

IN THE CIRCUIT COURT OF THE
15th JUDICIAL CIRCUIT IN AND
FOR PALM BEACH COUNTY,
FLORIDA

PROSKAUER ROSE, LLP, a New York
limited partnership,

CASE NO.: CA 01-04671 AB

Plaintiff,

vs.

IVIEWIT.COM, INC., a Delaware
corporation, IVIEWIT HOLDINGS,
INC., a Delaware corporation and,
IVIEWIT TECHNOLOGIES, INC.,
a Delaware corporation,

Defendants,

COUNTERCLAIM FOR DAMAGES

COME NOW the Counter Plaintiffs, IVIEWIT.COM, INC., IVIEWIT
HOLDINGS, INC., IVIEWIT TECHNOLOGIES, INC. and IVIEWIT LLC,
hereinafter collectively referred to as "IVIEWIT" or Counter Plaintiffs, and hereby
sues Counter Defendant, PROSKAUER ROSE, LLP, hereinafter "PROSKAUER",
a New York limited partnership, and alleges as follows:

GENERAL ALLEGATIONS COMMON TO ALL COUNTS

1. This is an action for damages in a sum greater than \$15,000.00, exclusive

of interest, taxable costs and attorneys fees.

2. Counter Plaintiff, IVIEWIT.COM, INC., is a Delaware corporation, formed by PROSKAUER, which at all times relevant hereto was authorized to conduct and conducted business in Palm Beach County Florida and the State of California.

3. Counter Plaintiff, IVIEWIT HOLDINGS, INC., is a Delaware corporation, formed by PROSKAUER, which at all times relevant hereto was authorized to conduct and conducted business in Palm Beach County Florida and California.

4. Counter Plaintiff, IVIEWIT TECHNOLOGIES, INC., is a Delaware corporation, formed by PROSKAUER, which at all times relevant hereto was authorized to conduct and conducted business in Palm Beach County Florida and the State of California.

5. IVIEWIT LLC, is a Florida limited liability company, formed by PROSKAUER, which, at all times relevant hereto, was authorized to conduct and conducted business in the Palm Beach County Florida and the State of California.

6. Counter Defendant PROSKAUER ROSE, LLP, (hereinafter "PROSKAUER") is a New York limited partnership, operating a law office in Boca Raton, Palm Beach County, Florida.



Lorraine Christine Hoffman, Esq.
Assistant Staff Counsel
The Florida Bar
File No. 2003-51, 109(15C)

Boca Raton, Palm Beach County, Florida.

7. BRIAN G. UTLEY, (hereinafter "UTLEY") was at all times relevant hereto a sui juris resident of the State of Florida and who on or about September of 1999 was the president of Counter Plaintiff, IVIEWIT LLC.

8. CHRISTOPHER WHEELER, (hereinafter "WHEELER") is a sui juris individual and resident of Palm Beach County, Florida, who at all times relevant hereto was a partner of PROSKAUER and who provided legal services to the Counter Plaintiffs.

9. KENNETH RUBENSTEIN, (hereinafter "RUBENSTEIN") is a sui juris individual believed to be a resident of the State of New York and who various times relevant hereto was initially misrepresented by WHEELER as a partner of PROSKAUER and later became a partner of PROSKAUER, and who provided legal services to the Counter Plaintiffs both while at Meltzer, Lippie, et al., and PROSKAUER.

10. RAYMOND JOAO, (hereinafter "JOAO") is a sui juris individual believed to be a resident of the State of New York and who at all times relevant hereto was represented to be RUBENSTEIN's associate at PROSKAUER, when in fact JOAO has never been an employee of PROSKAUER but in fact was an employee of Meltzer, Lippie, et al.



Lorraine Christine Hoffman, Esq.
Assistant Staff Counsel
The Florida Bar
File No. 2003-51, 109(15C)

11. That beginning on or about November of 1998, the Counter Plaintiff, IVIEWIT, through it's agent and principal, Eliot I. Bernstein ("Bernstein"), held discussions with WHEELER with regard to PROSKAUER providing legal services to the company involving specific technologies developed by Bernstein and two others, which technologies allowed for:

i) Zooming of digital images and video without degradation to the quality of the digital image due to what is commonly refereed to as "pixilation"; and,

ii) The delivery of digital video using proprietary scaling techniques; and,

iii) A combination of the image zoom techniques and video scaling techniques described above; and,

iv) The remote control of video cameras through communications networks.

12. That Bernstein engaged the services of PROSKAUER to provide legal services to the company to be formed, including corporate formation and governance for a single entity and to obtain multiple patents and oversee US and foreign filings for such technologies including the provisional filings for the technologies as described in Paragraph 11 above, the "Technology", and such



Lorraine Christine Hoffman, Esq.
Assistant Staff Counsel
The Florida Bar
File No. 2003-51, 109(15C)

other activities as were necessary to protect the intellectual property represented by the Technology.

13. That at the time of the engagement of PROSKAUER, Bernstein was advised and otherwise led to believe that WHEELER was the PROSKAUER partner in charge of the account.

14. Upon information and belief, WHEELER, RUBENSTEIN and JOAO upon viewing the technologies developed by Bernstein, and held by IVIEWIT, realized the significance of the technologies, its various applications to communication networks for distributing video data and images and for existing digital processes, including, but not limited to digital cameras, digital video disks (DVD), digital imaging technologies for medical purposes and digital video, and that WHEELER, RUBENSTEIN and JOAO conspired to undertake and in fact undertook a deliberate course of conduct to deprive Bernstein and IVIEWIT of the beneficial use of such technologies for either the use of third parties, who were other clients of PROSKAUER and WHEELER, or for WHEELER, RUBENSTEIN and JOAO's own financial gain, to the detriment and damage of the Counter Plaintiffs.

15. That WHEELER, who was a close personal friend of UTLEY, recommended to Bernstein and other members of the board of directors of



Lorraine Christine Hoffman, Esq.
Assistant Staff Counsel
The Florida Bar
File No. 2003-51, 109(15C)

IVIEWIT that the IVIEWIT engage the services of UTLEY to act as President of the Iviewit.com, LLC based on his knowledge and ability as to technology issues.

16. That at the time that WHEELER made the recommendation of UTLEY to the board of directors, that WHEELER knew that UTLEY was in a dispute with his former employer, Diamond Turf Products and the fact that UTLEY had misappropriated certain patents on hydro-mechanical systems to the detriment of Diamond Turf Products.

17. Additionally, WHEELER was fully aware of the fact that UTLEY was not the highly qualified "engineer" that UTLEY represented himself to be, and that in fact UTLEY lacked real engineering expertise or even an engineering degree and that UTLEY had been fired from Diamond Turf Products due to his misappropriation of patents.

18. That despite such knowledge, WHEELER never mentioned such facts concerning UTLEY to any representative of IVIEWIT and in fact undertook to "sell" UTLEY as a highly qualified candidate who would be the ideal person to undertake day to day operations of IVIEWIT and work on the patents, acting as a qualified engineer.

19. Additionally, WHEELER continued to assist UTLEY in perpetrating such fraud on both the Board of Directors of IVIEWIT and to third parties,



Lorraine Christine Hoffman, Esq.
Assistant Staff Counsel
The Florida Bar
File No. 2003-51, 109(15C)

including Wachovia Bank, by approving a false resume for UTLEY to be included in seeking approval of a private placement for IVIEWIT.

20. That based on the recommendations of WHEELER, as partner of PROSKAUER, the board of directors agreed to engage the services of UTLEY as president.

21. That almost immediately after UTLEY's employment and almost one year after initially providing of services, WHEELER provided a retainer agreement for the providing of services by PROSKAUER to IVIEWIT LLC, addressed to UTLEY, a true and correct copy of such retainer agreement (the "Retainer") being attached hereto and made a part hereof as Exhibit "A". That the services provided were in fact to be paid out of the royalties recovered from the use of the Technology, which was to be included in patent pools overseen by RUBENSTEIN.

22. That the Retainer by its terms contemplated the providing of corporate and general legal services to IVIEWIT LLC by PROSKAUER and was endorsed by UTLEY on behalf of IVIEWIT LLC, the Board of Directors of IVIEWIT LLC would not have UTLEY authorized to endorse same as it did not include the intellectual property work which PROSKAUER had already undertaken.

23. That prior to the Retainer, PROSKAUER and WHEELER had provided



Lorraine Christine Hoffman, Esq.
Assistant Staff Counsel
The Florida Bar
File No. 2003-51, 109(15C)

legal services to IVIEWIT, including services regarding patent procurement and acted to coordinate such services both internally and with outside counsel, including RUBENSTEIN and JOAO, including times when they were misrepresented as PROSKAUER attorneys.

24. That PROSKAUER billed IVIEWIT for legal services related to corporate, patent, trademark and other work in a sum of approximately \$800,000.00.

25. That PROSKAUER billed IVIEWIT for legal service never performed, double-billed by the use of multiple counsel on the same issue, and systematically overcharged for services provided.

26. That summaries of the billing statements provided by PROSKAUER to IVIEWIT are attached hereto and made a part hereof as Exhibit "B".

27. That based on the over-billing by PROSKAUER, IVIEWIT paid a sum in of approximately \$500,000.00 plus together with a 2.5% interest in IVIEWIT, which sums and interest in IVIEWIT was received and accepted by PROSKAUER.

28. That WHEELER, UTLEY, RUBENSTEIN, JOAO and PROSKAUER, conspired to deprive IVIEWIT of its rights to the technologies developed by Bernstein by:



Lorraine Christine Hoffman, Esq.
Assistant Staff Counsel
The Florida Bar
File No. 2003-51, 109(15C)

a) Transferring patents using Foley & Lardner so as to name UTLEY as the sole holder of multiple patents in his individual name and capacity when in fact they were and arose from the technologies developed by Bernstein and others and held by IVIEWIT prior to UTLEY's employment with IVIEWIT, and;

b) Upon discovery of the "lapses" by JOAO, that WHEELER and PROSKAUER referred the patent matters to WILLIAM DICK, of Foley & Lardner, who was also a close personal friend of UTLEY and who had been involved in the diversion of patents to UTLEY at Diamond Turf Products; and,

c) Failing to list proper inventors of the technologies based on improper legal advise that foreign inventors could not be listed until their immigration status was adjusted, resulting in the failure of the patents to include their rightful and lawful inventors and the payment by IVIEWIT for unnecessary immigration work; and,

d) Failing to ensure that the patent applications for the technologies, contained all necessary and pertinent information relevant to the technologies and as required by law; and,

e) Failing to secure trademarks and copyrights and failing to complete trademark and copyright work for the use of proprietary names of IVIEWIT and source code for the Technologies of IVIEWIT as intellectual property, and;



Lorraine Christine Hoffman, Esq.
Assistant Staff Counsel
The Florida Bar
File No. 2003-51, 109(15C)

f) Allowing the infringement of patent rights of IVEIWIT and the intellectual property of IVIEWIT by other clients of PROSKAUER and WHEELER, and;

g) Aiding JOAO in filing patents for IVIEWIT intellectual property by intentionally withholding pertinent information from such patents and not filing same timely, so as to allow JOAO to apply for similar patents in his own name, both while acting as counsel for IVIEWIT and subsequently.

29. As a direct and proximate result of the actions of the Counter Defendant, Counter Plaintiffs have been damaged in a sum estimated to be greater than \$10,000,000,000.00, based on projections by Gerald Stanley, CEO of Real 3-D (a consortium of Lockheed, Silicone Graphics and Intel) as to the value of the technologies and their applications to current and future uses together with the loss of funding from Crossbow Ventures as a result of such conduct.

30. All conditions precedent to the bringing of this action have occurred or have been waived or excused.

COUNT I- LEGAL MALPRACTICE

31. This is an action for legal malpractice within the jurisdiction of this court.

32. Counter Plaintiff re-alleges and hereby incorporates that allegations of Paragraphs 1 through 30 as if fully set forth herein.



Lorraine Christine Hoffman, Esq.
Assistant Staff Counsel
The Florida Bar
File No. 2003-51, 109(15C)

33. PROSKAUER employed by IVIEWIT for purposes of representing IVIEWIT to obtain multiple patents and oversee foreign filings for such technologies including the provisional filings for the technologies as described in Paragraph 11 above.

34. That pursuant to such employment, PROSKAUER owed a duty to ensure that the rights and interests of IVIEWIT were protected.

35. WHEELER, RUBENSTEIN, JOAO and PROSKAUER neglected that reasonable duty of care in the performance of legal services in that they:

a) Failed to take reasonable steps to ensure that the intellectual property of IVIEWIT was protected; and,

b) Failed to complete work regarding copyrights and trademarks; and,

c) Engaged in unnecessary and duplicate corporate and other work resulting in billing for unnecessary legal services believed to be in excess of \$400,000.00; and,

d) By redacting information from the billing statements regarding services provided so to as to give the appearance that the services provided by PROSKAUER were limited in nature, when in fact they involved various aspects of intellectual property protection; and,

e) By knowingly representing and agreeing to accept representation of



Lorraine Christine Hoffman, Esq.
Assistant Staff Counsel
The Florida Bar
File No. 2003-51, 109(15C)

clients in conflict with the interests of IVIEWIT, without either consent or waiver by IVIEWIT.

36. That the negligent actions of PROSKAUER and its partners, WHEELER and RUBENSTEIN, resulted in and was the proximate cause of loss to IVIEWIT.

WHEREFORE, Counter Plaintiff demands judgement for damages against Defendant together with reasonable attorneys fees, court costs, interest and such other and further relief as this Court deems just and equitable.

COUNT II- CIVIL CONSPIRACY

37. This is an action for civil conspiracy within the jurisdiction of this court.

38. Counter Plaintiff re-alleges and hereby incorporates that allegations of Paragraphs 1 through 30 as if fully set forth herein.

39. Defendant, PROSKAUER and UTLEY, WHEELER, RUBENSTEIN and JOAO, jointly conspired to deprive the Counter Plaintiffs of their rights and interest in the Technology.

40. That UTLEY, WHEELER, RUBENSTEIN, JOAO and PROSKAUER with such intent, directed that certain patent rights be put in the name of UTLEY and/or that such patent rights were modified or negligently pursued so as to fail to provide protection of the intellectual property, resulting in the ability of other clients of WHEELER, RUBENSTEIN, JOAO and PROSKAUER to make use of such



Lorraine Christine Hoffman, Esq.
Assistant Staff Counsel
The Florida Bar
File No. 2003-51, 109(15C)

technologies without being liable to IVIEWIT for royalties normally arising from such use.

41. That PROSKAUER, without either consent of the Board of Directors or proper documentation, transferred securities to Tiedemann/Prolow Investment Group, which entity was also referred by WHEELER, who acted as counsel for such unauthorized transaction.

42. That upon the discovery of the above-described events and conspiracy, IVIEWIT's lead investor, Crossbow Ventures, ceased its funding of IVIEWIT.

43. That Crossbow Ventures, which was a referral of WHEELER, took a security interest in the Technology under the guise of protecting IVIEWIT and its shareholders from the actions of UTLEY, based on the filing of an involuntary bankruptcy (which was later withdrawn), and as to WHEELER and PROSKAUER based on the instant law suit, when in fact such conduct was motivated by Crossbow's attempts to wrongfully detain the interests of IVIEWIT in the Technology. Such conduct, upon information and belief, was undertaken with the knowledge and assistance of WHEELER and PROSKAUER.

44. As a direct and proximate result of the conspiracy and acts of PROSKAUER, UTLEY, WHEELER, JOAO and RUBENSTEIN, the Counter Plaintiffs have been damaged.



Lorraine Christine Hoffman, Esq.
Assistant Staff Counsel
The Florida Bar
File No. 2003-51, 109(15C)

WHEREFORE, Counter Plaintiffs demand judgement for damages against Defendant together with court costs, interest and such other and further relief as this Court deems just and equitable.

COUNT III- BREACH OF CONTRACT

45. This is an action for breach of contract within the jurisdiction of this Court.

46. Counter Plaintiff re-alleges and hereby incorporates that allegations of Paragraphs 1 through 30 as if fully set forth herein.

47. Defendant, PROSKAUER, breached the contract with Counter Plaintiff, IVIEWIT LLC by failing to provide services billed for pursuant to the billing statements presented to the Counter Plaintiffs and over-billing for services provided.

48. That such actions on the part of PROSKAUER constitute beaches of the contract by and between IVIEWIT LLC and PROSKAUER.

49. That as a direct and proximate result of such conduct on the part of PROSKAUER, IVIEWIT LLC has been damaged by overpayment to PROSKAUER and the failure of PROSKAUER to perform the contracted for legal services.

WHEREFORE, IVIEWIT demands judgement for damages against Counter Defendant together with court costs, interest and such other and further relief as this Court deems just and equitable.



Lorraine Christine Hoffman, Esq.
Assistant Staff Counsel
The Florida Bar
File No. 2003-51, 109(15C)

**COUNT IV- TORTIOUS INTERFERENCE WITH AN ADVANTAGEOUS
BUSINESS RELATIONSHIP**

50. This is an action for tortious interference with an advantageous business relationship within the jurisdiction of this Court.

51. Counter Plaintiff re-alleges and hereby incorporates that allegations of Paragraphs 1 through 30 as if fully set forth herein.

52. Counter Plaintiff was engaged in negotiations of technology agreements with both Warner Bros. and AOL/Time Warner as to the possible use of the Technologies of the Counter Plaintiffs and investment in Counter Plaintiffs as a strategic partner.

53. That despite the prior representations of RUBENSTEIN, at a meeting held on or about November 1, 2000, by and between UTLEY, RUBENSTEIN and representatives of Warner Bros. as to the Technology of IVIEWIT and the efficacy, novelty and unique methodology of the Technology, RUBENSTEIN refused to subsequently make the same statements to representatives of AOL and Warner Bros., taking the position that since Warner Bros./AOL is "now a big client of Proskauer, I can't comment on the technologies of Iviewit." or words to that effect in response to inquiry from Warner Brother/AOL's counsel as to the status and condition of the pending patents on the intellectual property.



Lorraine Christine Hoffman, Esq.
Assistant Staff Counsel
The Florida Bar
File No. 2003-51, 109(15C)

54. That RUBENSTEIN, having served as an advisor to the Board of Directors for IVIEWIT, was aware of the fact that at the time of the making of the statements set forth in Paragraph 50, above, IVIEWIT was in the midst of negotiations with AOL/Warner Bros. as to the possible funding of the operations of IVIEWIT in and sum of between \$10,000,000.00 and \$20,000,000.00.

55. Further, RUBENSTEIN as a partner of PROSKAUER, and despite his clear prior actions in representing the interests of IVIEWIT, refused to answer questions as to the enforcement of the Technology of IVIEWIT, with the intent and knowledge that such refusal would lead to the cessation of the business relationship by and between IVIEWIT and Warner Bros./AOL and other clients familiar with the Warner Bros./AOL technology group then in negotiations with IVIEWIT, including, but not limited to Sony Corporation, Paramount, MGM and Fox.

56. That the actions of RUBENSTEIN were and constituted an intentional and unjustified interference with the relationship by and between IVIEWIT and Warner Bros./AOL designed to harm such relationship and further motivated by the attempts to "cover-up" the conflict of interest in PROSKAUER's representation of both IVIEWIT and Warner Bros./AOL.

57. That indeed, as a direct and proximate result of the conduct of RUBENSTEIN, Warner Bros./AOL ceased business relations with IVIEWIT to the



Lorraine Christine Hoffman, Esq.
Assistant Staff Counsel
The Florida Bar
File No. 2003-51, 109(15C)

damage and detriment of Counter Plaintiffs.

WHEREFORE, Counter Plaintiffs demand judgement for damages against Counter Defendant together with court costs, interest and such other and further relief as this Court deems just and equitable.

I HEREBY CERTIFY that a true and correct copy of the foregoing has been provided by U.S. Mail and fax transmission this 10th day of January, 2003 to: Christopher W. Prusaski, Esq., Proskauer Rose, LLP, 2255 Glades Road, Suite 340 W, Boca Raton, FL 33431.

SELZ & MUVDI SELZ, P.A.
214 Brazilian Avenue, Suite 220
Palm Beach, FL 33480
Tel: (561) 820-9409
Fax: (561) 833-9715

By: 

STEVEN M. SELZ
FBN: 777420



Lorraine Christine Hoffman, Esq.
Assistant Staff Counsel
The Florida Bar
File No. 2003-51, 109(15C)

Exhibit B – Tiedemann/Prolow Loan Documents
Unsigned at time of transaction Convertible Promissory Note



Lorraine Christine Hoffman, Esq.
 Assistant Staff Counsel
 The Florida Bar
 File No. 2003-51, 109(15C)

THIS CONVERTIBLE PROMISSORY NOTE HAS NOT BEEN REGISTERED OR QUALIFIED UNDER THE SECURITIES ACT OF 1933, AS AMENDED, OR ANY STATE SECURITIES LAWS. NEITHER THIS CONVERTIBLE PROMISSORY NOTE NOR ANY INTEREST THEREIN (INCLUDING THE SHARES OF CLASS B NON-VOTING COMMON STOCK INTO WHICH THIS NOTE IS CONVERTIBLE) MAY BE OFFERED, SOLD, PLEDGED, OR OTHERWISE TRANSFERRED UNLESS THIS CONVERTIBLE PROMISSORY NOTE IS FIRST REGISTERED UNDER THE SECURITIES ACT OF 1933, AS AMENDED, AND/OR QUALIFIED UNDER ALL APPLICABLE STATE SECURITIES LAWS, OR UNTIL THE COMPANY SHALL HAVE RECEIVED AN OPINION OF LEGAL COUNSEL, REASONABLY SATISFACTORY TO THE COMPANY, THAT THIS CONVERTIBLE PROMISSORY NOTE MAY LAWFULLY BE OFFERED, SOLD, PLEDGED, OR OTHERWISE TRANSFERRED WITHOUT SUCH REGISTRATION AND/OR QUALIFICATION IN RELIANCE UPON AN APPLICABLE EXEMPTION.

**iviewit HOLDINGS, INC.
 CONVERTIBLE PROMISSORY NOTE**

Interest Rate: 10% per year
 Convertible into shares of Class B Non-Voting Common Stock of iviewit HOLDINGS, INC.
 at \$387.59 per Share, subject to adjustment

Boca Raton, Florida

Amount: \$345,000
 Dated: _____, 2001

For value received, iviewit HOLDINGS, INC., a Delaware corporation, whose address is 2255 Glades Road, Suite 337W, Boca Raton, Florida 33431 ("Company"), promises to pay to Tiedemann Prolow, LLC, a New York limited liability company having an address of 535 Madison Avenue, 37th Floor, New York, NY 10022 ("Payee"), the principal amount of Three Hundred Forty Five Thousand Dollars (\$345,000), together with interest from the date hereof at the rate of ten percent (10%) per year.

This Convertible Promissory Note ("Note") is issued pursuant to a Subscription Agreement (the "Subscription Agreement") between the Company and the Payee, in connection with an offering of a Unit consisting of (i) a \$345,000 principal amount convertible promissory note and (ii) warrants to purchase up to 1,780 shares of the Class B Non-Voting Common Stock of the Company (the "Offering") of which this Note is a part.

This Note is subject to the following terms and conditions:

1. Principal and Interest Payments.

- a. This Note bears interest from the date hereof at a rate of ten (10%) per year, which will accrue daily from the date of this Note and be payable on the Due Date (as herein defined), which interest payments may be made in the form of cash, shares of the Company's Class B Non-Voting Common Stock, \$.01 par value ("Class B Common Stock") or a combination of cash and shares, in the Payee's sole discretion.
- b. The entire unpaid principal, together with any accrued but unpaid interest, shall be due and payable in full on _____, 2004 [the third anniversary of the date of this Note] (the "Due Date").
- c. All computations of interest made or called for herein shall be made on the basis of a 366-day year (or the actual number of days elapsed).
- d. All payments due on this Note shall be applied first to accrued interest, and second, to any remainder in payment of principal.



Lorraine Christine Hoffman, Esq.
Assistant Staff Counsel
The Florida Bar
File No. 2003-51, 109(15C)

e. Except as otherwise provided in this Note, all payments of principal and interest on this Note shall be paid in the legal currency of the United States of America.

f. The Company shall be responsible for all applicable Florida documentary stamp taxes, and similar taxes, on this Note.

2. Optional Prepayments. The Company may, without penalty, prepay this Note in whole or in part, at any time upon thirty (30) days prior written notice to the Payee (the "Company Notice"). Payee shall have twenty (20) days after receipt of the Company Notice to provide the Company with written notice of Payee's intent to convert this Note into fully paid and non-assessable shares of Class B Common Stock, in accordance with, and based upon the applicable conversion rate in effect at any time as, described in Section 3 below, subject to adjustments in accordance with Section 4 below.

3. Conversion of Note.

a. At any time from the date hereof until eighteen (18) months following the date hereof, the Payee has the right, at the Payee's option (and subject to prepayment in full of the principal balance of this Note pursuant to Section 2 above) to convert the then outstanding principal under this Note, in accordance with provisions hereof, in whole or in part, into fully paid and non-assessable shares of Class B Common Stock, based upon the applicable conversion rate ("Applicable Conversion Rate") as follows: (i) The principal amount plus any accrued but unpaid interest amount of the Note, divided by (ii) Three Hundred Eighty-Seven and 59/100 Dollars (\$387.59), subject to adjustment in accordance with Section 4 below.

b. Before the Payee shall be entitled to convert this Note into shares of Class B Common Stock, the Payee shall surrender this Note at the office of the Company and shall give written notice by mail, postage prepaid, to the Company at its principal corporate office, of the election to convert the same in the form attached hereto as Exhibit A. The Company shall, as soon as practicable thereafter, issue and deliver at such office to the Payee of this Note a certificate or certificates (bearing such legends as are required by the Subscription Agreement and applicable state and federal securities laws in the opinion of counsel to the Company) for the number of shares of Class B Common Stock to which the Payee of this Note shall be entitled as aforesaid. Upon a partial conversion of this Note, there shall be countersigned and issued to the Payee hereof a replacement Note in respect of the shares of Class B Common Stock as to which this Note shall not have been converted. Such conversion shall be deemed to have been made immediately prior to the close of business on the date of such surrender of this Note, and the Payee shall be treated for all purposes as the record Payee of such shares of Class B Common Stock as of such date.

c. As promptly as practicable after the conversion of this Note, the Company at its expense will issue and deliver to the Payee of this Note a certificate or certificates for the number of full shares of Class B Common Stock issuable upon such conversion. Payee acknowledges that such shares will not be registered under applicable state and federal securities laws, will constitute restricted securities under such laws and will bear a restrictive legend as to their transferability as more particularly described in the Subscription Agreement.

4. Adjustment to Applicable Conversion Rate.

a. Adjustment for Stock Splits and Subdivisions. In the event the Company should at any time or from time to time after the date of issuance hereof fix a record date for the effectuation of a split or subdivision of the outstanding shares of Common Stock or the determination of holders of Common Stock entitled to receive a dividend or other distribution payable in additional shares of Common Stock or other securities or rights convertible into, or entitling the holder thereof to receive directly or indirectly, additional shares of Common Stock (hereinafter referred to as "Common Stock Equivalents") without payment of any consideration by such holder for the additional shares of Common Stock Equivalents (including the additional shares of Common Stock issuable upon conversion or exercise thereof), then, as of such record date (or the date of such dividend distribution, split or subdivision if no record date is fixed), the Conversion Price of this Note shall be appropriately decreased so that the number of shares of Common Stock issuable upon conversion of this Note shall be increased in proportion to such increase of outstanding shares.



Lorraine Christine Hoffman, Esq.
Assistant Staff Counsel
The Florida Bar
File No. 2003-51, 109(15C)

e. Except as otherwise provided in this Note, all payments of principal and interest on this Note shall be paid in the legal currency of the United States of America.

f. The Company shall be responsible for all applicable Florida documentary stamp taxes, and similar taxes, on this Note.

2. Optional Prepayments. The Company may, without penalty, prepay this Note in whole or in part, at any time upon thirty (30) days prior written notice to the Payee (the "Company Notice"). Payee shall have twenty (20) days after receipt of the Company Notice to provide the Company with written notice of Payee's intent to convert this Note into fully paid and non-assessable shares of Class B Common Stock, in accordance with, and based upon the applicable conversion rate in effect at any time as, described in Section 3 below, subject to adjustments in accordance with Section 4 below.

3. Conversion of Note.

a. At any time from the date hereof until eighteen (18) months following the date hereof, the Payee has the right, at the Payee's option (and subject to prepayment in full of the principal balance of this Note pursuant to Section 2 above) to convert the then outstanding principal under this Note, in accordance with provisions hereof, in whole or in part, into fully paid and non-assessable shares of Class B Common Stock, based upon the applicable conversion rate ("Applicable Conversion Rate") as follows: (i) The principal amount plus any accrued but unpaid interest amount of the Note, divided by (ii) Three Hundred Eighty-Seven and 59/100 Dollars (\$387.59), subject to adjustment in accordance with Section 4 below.

b. Before the Payee shall be entitled to convert this Note into shares of Class B Common Stock, the Payee shall surrender this Note at the office of the Company and shall give written notice by mail, postage prepaid, to the Company at its principal corporate office, of the election to convert the same in the form attached hereto as Exhibit A. The Company shall, as soon as practicable thereafter, issue and deliver at such office to the Payee of this Note a certificate or certificates (bearing such legends as are required by the Subscription Agreement and applicable state and federal securities laws in the opinion of counsel to the Company) for the number of shares of Class B Common Stock to which the Payee of this Note shall be entitled as aforesaid. Upon a partial conversion of this Note, there shall be countersigned and issued to the Payee hereof a replacement Note in respect of the shares of Class B Common Stock as to which this Note shall not have been converted. Such conversion shall be deemed to have been made immediately prior to the close of business on the date of such surrender of this Note, and the Payee shall be treated for all purposes as the record Payee of such shares of Class B Common Stock as of such date.

c. As promptly as practicable after the conversion of this Note, the Company at its expense will issue and deliver to the Payee of this Note a certificate or certificates for the number of full shares of Class B Common Stock issuable upon such conversion. Payee acknowledges that such shares will not be registered under applicable state and federal securities laws, will constitute restricted securities under such laws and will bear a restrictive legend as to their transferability as more particularly described in the Subscription Agreement.

4. Adjustment to Applicable Conversion Rate.

a. Adjustment for Stock Splits and Subdivisions. In the event the Company should at any time or from time to time after the date of issuance hereof fix a record date for the effectuation of a split or subdivision of the outstanding shares of Common Stock or the determination of holders of Common Stock entitled to receive a dividend or other distribution payable in additional shares of Common Stock or other securities or rights convertible into, or entitling the holder thereof to receive directly or indirectly, additional shares of Common Stock (hereinafter referred to as "Common Stock Equivalents") without payment of any consideration by such holder for the additional shares of Common Stock Equivalents (including the additional shares of Common Stock issuable upon conversion or exercise thereof), then, as of such record date (or the date of such dividend distribution, split or subdivision if no record date is fixed), the Conversion Price of this Note shall be appropriately decreased so that the number of shares of Common Stock issuable upon conversion of this Note shall be increased in proportion to such increase of outstanding shares.

4708/40017-001 BRLIB1/287912 v4

03/20/01 09:49 AM (11111)



Lorraine Christine Hoffman, Esq.
Assistant Staff Counsel
The Florida Bar
File No. 2003-51, 109(15C)

11. WAIVER OF JURY TRIAL. THE COMPANY, BY EXECUTION HEREOF, AND THE PAYEE, BY ACCEPTANCE HEREOF, MUTUALLY AND WILLINGLY WAIVE THE RIGHT TO A TRIAL BY JURY OF ANY AND ALL CLAIMS MADE BETWEEN THEM WHETHER NOW EXISTING OR ARISING IN THE FUTURE, INCLUDING WITHOUT LIMITATION, ANY AND ALL CLAIMS, DEFENSES, COUNTERCLAIMS, CROSS CLAIMS, THIRD PARTY CLAIMS AND INTERVENERS'S CLAIMS WHETHER ARISING FROM OR RELATED TO THE NEGOTIATION, EXECUTION AND PERFORMANCE OF THE TRANSACTIONS TO WHICH THIS NOTE RELATES.

IN WITNESS WHEREOF, the Company has caused this Note to be executed on the day and year first above written.

iviewit HOLDINGS, INC.

By: _____
Brian G. Utley, President



Lorraine Christine Hoffman, Esq.
 Assistant Staff Counsel
 The Florida Bar
 File No. 2003-51, 109(15C)

EXHIBIT "A"

INSTRUCTIONS TO CONVERT

The undersigned hereby surrenders the attached 10% Convertible Promissory Note due _____, 2004 (the "Note") of iviewit Holdings, Inc., a Delaware corporation ("iviewit"), in the principal amount of \$345,000 for conversion into shares of iviewit's Class B Non-Voting Common Stock ("Class B Common Stock") in accordance with Section 3 of the Note relating to voluntary conversion, as noted below. Such Note was issued pursuant to that certain Subscription Agreement dated _____, 2001 with iviewit (the "Subscription Agreement"). The undersigned represents that he/she/it is the beneficial owner and Payee of record of the Note, and that no other person has any lien, security interest or interest of any kind in the Note and that he/she/it has full and legal right to surrender the Note for conversion. The undersigned further renounces as to the shares of Class B Common Stock to be issued to the undersigned pursuant to these instructions the representations and warranties set forth in subsections 6.2 (a), (b), (e), (f), (g) and (h) of the Subscription Agreement.

() The Undersigned elects to convert the Note in full including the remaining principal of \$ _____ and accrued interest of \$ _____, which equals a conversion of \$ _____.

() The Undersigned elects to convert the Note in part equal to a principal amount of \$ _____ and accrued interest of \$ _____, which equals a conversion of \$ _____. An identical Note shall be reissued for the amount of remaining principal.

Dated this _____ day of _____, _____.

In the presence of:

 Witness

 Signature of Note Payee

Signature guarantee:

Signature must be guaranteed by a commercial bank or member firm of the New York Stock Exchange.



Lorraine Christine Hoffman, Esq.
Assistant Staff Counsel
The Florida Bar
File No. 2003-51, 109(15C)

EXHIBIT "B"
Form of Warrant

1708/40017-001 BRLIB1/287673 v6

B-I

03/20/01 09:43 AM (11111)



Lorraine Christine Hoffman, Esq.
Assistant Staff Counsel
The Florida Bar
File No. 2003-51, 109(15C)

Warrant Certificate

Note that the warrant although part of the Proskauer Rose documents for this transaction, is never completed with their documents and instead is signed by Raymond Hersh a month after the transaction and sent 2 months later to the investor.



Lorraine Christine Hoffman, Esq.
Assistant Staff Counsel
The Florida Bar
File No. 2003-51, 109(15C)



"I view it!"

www.iviewit.com

2255 Glades Road
One Boca Place - Suite 337W
Boca Raton, FL 33431
Voice: 561.999.8899
Fax: 561.999.8810
Toll: 877.484.8444

Via Mail

April 27, 2001

Tiedemann Investment Group
Attn: Bruce Prolow
535 Madison Avenue, 36th Floor
New York, NY 10022

Dear Bruce:

Relative to your investment of \$345,000 in iviewit Holdings Inc. I am pleased to enclose the Warrant which supplements the actual Convertible Promissory Note issued for the investment itself. This Warrant is consistent with the Term Sheet which we presented to you last November, and the \$345,000 translates to 1880 Warrant Shares described in the Warrant itself.

Thank you for your confidence in us, and I hope and trust that this will result in a mutually profitable investment.

Kindest regards.

Sincerely,

Raymond Hersh
Vice President of Finance

encl. Warrant Certificate for Purchase of Class A Voting Common Stock
Private Placement Offering Term Sheet

RH/bb



Lorraine Christine Hoffman, Esq.
Assistant Staff Counsel
The Florida Bar
File No. 2003-51, 109(15C)



Lorraine Christine Hoffman, Esq.
Assistant Staff Counsel
The Florida Bar
File No. 2003-51, 109(15C)

WARRANT No. 01/04/Q

**WARRANT CERTIFICATE FOR PURCHASE OF
CLASS A VOTING COMMON STOCK**

THIS WARRANT AND THE CLASS A VOTING COMMON STOCK PURCHASABLE HEREUNDER HAVE NOT BEEN REGISTERED UNDER THE SECURITIES ACT OF 1933, AS AMENDED OR ANY STATE SECURITIES LAW. NEITHER THIS WARRANT NOR THE CLASS A VOTING COMMON STOCK PURCHASABLE HEREUNDER MAY BE SOLD, OFFERED FOR SALE, PLEDGED OR HYPOTHECATED IN THE ABSENCE OF A REGISTRATION STATEMENT IN EFFECT WITH RESPECT TO SUCH SECURITIES UNDER SUCH ACT AND ANY STATE APPLICABLE STATE SECURITIES LAWS OR AN OPINION OF COUNSEL SATISFACTORY TO THE COMPANY THAT SUCH REGISTRATION IS NOT REQUIRED.

Iviewit Holdings, Inc.

**Purchase Warrant for
Class A Voting Common Stock**

THIS WARRANT CERTIFICATE certifies that, FOR VALUE RECEIVED Tiedemann/Prolow II LLC (the "Holder"), 535 Madison Avenue, 36th Floor, New York, New York 10022, is entitled, subject to the terms and conditions set forth in this Warrant Certificate for Purchase of Class A Voting Common Stock (this "Warrant"), to purchase from Iviewit Holdings, Inc., a Delaware corporation (the "Company"), one thousand eight hundred eighty (1,880) shares ("Warrant Shares") of Class A Voting Common Stock, \$.01 par value, of the Company ("Class A Common Stock"), commencing on March 21, 2001, and ending at 5:00 p.m., New York time, on March 20, 2006 (the "Expiration Date"), at an exercise price of one hundred fifty-five dollars (\$155) per Warrant Share (the "Warrant Exercise Price"), such number of Warrant Shares and Warrant Exercise Price being subject to adjustment from time to time as set forth in Section 3 below. This Warrant may not be exercised after 5:00 p.m., NYC time, on the Expiration Date, at which time this Warrant, unless exercised prior thereto, shall thereafter be void.

This Warrant is subject to the following provisions, terms and conditions:



Lorraine Christine Hoffman, Esq.
Assistant Staff Counsel
The Florida Bar
File No. 2003-51, 109(15C)

SECTION 1. *Warrant Exercise.* Except as treated by the Holder under the Cashless Exercise Provision of Paragraph 7 herein, this Warrant may be exercised by the Holder hereof, in whole or in part, by the presentation and surrender of this Warrant with the form of the Election to Purchase Form attached hereto as SCHEDULE A, duly executed, at the principal office of the Company, and upon payment to the Company of the applicable Warrant Exercise Price in cash or by cashier's check payable to the order of the Company. The Warrant Shares so purchased shall be deemed to be issued to the Holder hereof as the record owner of such Warrant Shares as of the close of business on the date on which this Warrant shall have been surrendered and the Warrant Exercise Price per each Warrant Share shall have been paid by the Holder to and received by the Company. Upon the exercise of this Warrant, the issuance of certificates for Warrant Shares shall be made forthwith without charge to the Holder hereof including, without limitation, any tax which may be payable in respect of the issuance thereof, and such certificates shall be issued in the name of, or in such names as may be directed by, the Holder hereof; provided, however, that the Company shall not be required to pay any tax which may be payable in respect of any transfer involved in the issuance and delivery of any such certificates in a name other than that of the Holder and the Company shall not be required to issue or deliver such certificates unless or until the person or persons requesting the issuance thereof shall have paid to the Company the amount of such tax or shall have established to the satisfaction of the Company that such tax has been paid. Upon any partial exercise of this Warrant, there shall be countersigned and issued to the Holder hereof a new Warrant in respect of the Warrant Shares as to which this Warrant shall not have been exercised.

SECTION 2. *Reservation of Warrant Shares.* The Company covenants and agrees:

- (i) That all Warrant Shares which may be issued upon the exercise of the rights represented by this Warrant will, upon issuance, be fully paid and non-assessable and free from all taxes, liens and charges with respect to the issue thereof; and
- (ii) That during the period within which the rights represented by this Warrant may be exercised, the Company will at all times have authorized, and reserved for the purpose of issue and delivery upon exercise of the rights evidenced by this Warrant, a sufficient number of shares of Class A Common Stock to provide for the exercise of the rights represented by this Warrant.

SECTION 3. *Reorganization, Reclassification, Consolidation, Merger or Sale.*

A. ***Capital Events.*** If any reorganization or reclassification of the capital stock of the Company, or any consolidation or merger of the Company with or into a corporation or other entity, or the sale, transfer or other disposition of all or substantially all of its assets to a corporation or other entity (in any instance, a "Capital Event") shall be effected in such a way that holders of any shares of Class A Common Stock shall be entitled to receive shares of stock, securities or assets or cash or other consideration of value with respect to or in exchange for their shares of Class A Common Stock, then,



Lorraine Christine Hoffman, Esq.
Assistant Staff Counsel
The Florida Bar
File No. 2003-51, 109(15C)

as a condition of such Capital Event, lawful and adequate provisions shall be made whereby the Holder hereof shall thereafter have the right to purchase and receive upon the basis and upon the terms and conditions specified in this Warrant and in lieu of the Warrant Shares immediately theretofore purchasable and receivable upon the exercise of the rights represented hereby, an amount of the same or similar shares of stock, securities or assets as may have been issued or payable with respect to or in exchange for a number of outstanding shares of Class A Common Stock equal to the number of Warrant Shares immediately theretofore purchasable and receivable upon the exercise of the rights represented hereby as if such exercise occurred immediately prior to the Capital Event.

B. *Preservation of Value.* In the case of any Capital Event, appropriate provision shall be made with respect to the rights and interests of the Holder of this Warrant to the end that the provisions hereof (including, without limitation, provisions for adjustment of the number of Warrant Shares purchasable and receivable upon the exercise of this Warrant and the Warrant Exercise Price) shall thereafter be applicable, as nearly as may be, in relation to any shares of stock, securities or assets thereafter deliverable upon the exercise of the rights represented hereby.

C. *Subdivision or Combination of Shares.* If the Company shall at any time (i) subdivide or split its outstanding shares of Class A Common Stock into a greater number of shares or (ii) make a distribution to all holders of Class A Common Stock payable in additional shares of Class A Common Stock or other securities or rights convertible into, or which entitle the holder thereof to receive, directly or indirectly, additional shares of Class A Common Stock without payment of any consideration by such holder therefore, then the number of Warrant Shares subject to issuance upon exercise of this Warrant shall be proportionately increased. If the outstanding shares of Class A Common Stock of the Company shall be combined into a smaller number of shares, the number of Warrant Shares subject to issuance upon exercise of this Warrant shall be proportionately decreased. In any such event, the Warrant Exercise Price in effect immediately prior to such event shall be proportionately adjusted by multiplying it by a fraction, the numerator of which shall be the number of shares of Class A Common Stock outstanding immediately prior to such event and the denominator of which shall be the number of shares of Class A Common Stock outstanding immediately after such event.

D. *Dividends.* The Company may declare a dividend or make any other distribution upon any class or series of its capital stock without consideration to the Holder hereof.

SECTION 4. *Fractional Interests.* If any fraction of a Warrant Share is issuable on the exercise of this Warrant, the Company shall be required to and shall issue such fractional Warrant Share on the exercise of this Warrant.

SECTION 5. *No Rights as Stockholder.* Nothing contained in this Warrant shall be construed as conferring upon the Holder hereof or his transferees any rights as a stockholder of the Company.



Lorraine Christine Hoffman, Esq.
Assistant Staff Counsel
The Florida Bar
File No. 2003-51, 109(15C)

SECTION 6. *Registration Rights.*

6.1 *Piggyback Rights.* If at any time prior to the Expiration Date, the Company shall propose to register any of its common stock under the Securities Act of 1933, as amended (the "Securities Act") (other than pursuant to a transaction described under Rule 145 of the Securities Act or registration statements on forms S-4 or S-8 (or their successor forms)), the Company will include in such registration statement such information as is required, and such number of Warrant Shares held by the Holder as may be requested by him, to permit a public offering of the Warrant Shares so requested; provided, however, that in the case of an underwritten offering, if, in the written opinion of the Company's managing underwriter for such offering, the inclusion of the Warrant Shares requested to be registered, when added to the securities being registered by the Company or any other selling security holder(s), would exceed the maximum amount of the Company's securities that can be marketed without otherwise materially and adversely affecting the entire offering, then such managing underwriter may exclude from such offering that portion of the Warrant Shares requested to be so registered, so that the total number of securities to be registered is within the maximum number of shares that, in the opinion of the managing underwriter, may be marketed without otherwise materially and adversely affecting the entire offering. In the event of such a proposed registration, the Company shall furnish the Holder of Warrant Shares with not less than twenty (20) days' written notice prior to the proposed date of filing of such registration statement. Such notice shall continue to be given by the Company to the Holder of Warrant Shares, with respect to subsequent registration statements, until such time as all of the Warrant Shares have been registered or may be sold without registration under the Securities Act or applicable state securities laws and regulations, and without limitation as to volume, pursuant to Rule 144 of the Securities Act. The Holder of Warrant Shares shall exercise the rights provided for in this Section 6.1 by giving written notice to the Company, within fifteen (15) days of receipt of the Company's notice of its intention to file a registration statement. In the event the offering involves an underwritten offering, the Holder shall also execute, and be a party to, the underwriting agreement of the Company.

6.2 *Covenants of the Company With Respect to Registration.* In connection with any registration under Section 6.1 hereof, the Company covenants and agrees as follows:

(a) The Company shall pay all costs (excluding fees and expenses of counsel to the Holder and any underwriting or selling commissions or other charges of any broker-dealer acting on behalf of the Holder and except to the extent persons other than the Holder have agreed to pay such costs), fees and expenses in connection with all registration statements filed pursuant to Section 6.1 hereof.



Lorraine Christine Hoffman, Esq.
Assistant Staff Counsel
The Florida Bar
File No. 2003-51, 109(15C)

(b) The Company will take all necessary action which may be required in qualifying or registering the Warrant Shares included in a registration statement for offering and sale under the securities or blue sky laws of such states as is reasonably requested by the Holder, provided that the Company shall not be obligated to execute or file any general consent to service of process or to qualify as a foreign corporation to do business under the laws of any such jurisdiction.

(c) Nothing contained in this Agreement shall be construed as requiring the Holder to exercise this Warrant prior to the initial filing of any registration statement or the effectiveness thereof; provided that the provisions of Section 6.1 shall be applicable only for Warrant Shares held by the Holder and not with respect to any shares of Class A Common Stock underlying any Warrants not yet exercised.

(d) The Company shall deliver promptly to the Holder who shall have requested in writing the correspondence and memoranda described below and to the managing underwriters, if any, copies of all correspondence between the SEC and the Company, its counsel or auditors and all memoranda relating to discussions with the SEC or its staff with respect to the registration statement and permit the Holder and underwriter to do such investigation, upon reasonable advance notice, with respect to information contained in or omitted from the registration statement as it deems reasonably necessary to comply with applicable securities laws or rules of the NASD. Such investigation shall include access to books, records and properties and opportunities to discuss the business of the Company with its officers and independent auditors, all to such reasonable extent and at such reasonable times and as often as the Holder or underwriter shall reasonably request.

(e) The Company agrees that until all the Warrant Shares have been sold under a registration statement or pursuant to Rule 144 under the Securities Act, it shall use reasonable efforts to keep current in filing all reports, statements and other materials required to be filed with the SEC to permit the Holder of the Warrant Shares to sell such securities under Rule 144.

6.3 Black-Out Periods. The Holder agrees that, upon receipt of any notice from the Company of an "Amendment Event" (as defined below), the Holder will discontinue disposition of Warrant Shares pursuant to the registration statement until the Holder receives copies of the supplemented or amended prospectus which reflects the Amendment Event. If directed by the Company, the Holder will also deliver to the Company all copies, other than any permanent file copies then in the Holder's possession, of the most recent prospectus covering such Warrant Shares. An "Amendment Event" shall mean an event requiring the preparation of a supplement or amendment to the prospectus so that, as thereafter delivered to a purchaser of Warrant Shares, such prospectus would not contain an untrue statement of material fact or omit to state any material fact required to be stated therein or necessary to make the statements therein not misleading in light of the circumstances in which they were made.



Lorraine Christine Hoffman, Esq.
Assistant Staff Counsel
The Florida Bar
File No. 2003-51, 109(15C)

6.4 Survival. The rights and obligations set forth in this Section 6 shall survive the exercise and surrender of this Warrant.

SECTION 7. Cashless Exercise. The Holder may, at its election exercised in its sole discretion, exercise this Warrant in whole or in part and, in lieu of making the cash payment otherwise contemplated to be made to the Company upon such exercise in payment of the Exercise Price, elect instead to receive upon such exercise the "Net Number" of shares of Class A Common Stock determined according to the following formula (a "Cashless Exercise"):

$$\text{Net Number} = \frac{(A \times B) - (A \times C)}{B}$$

For purposes of the foregoing formula:

A = the total number of shares with respect to which this Warrant is then being exercised.

B = the fair market value of the Class A Common Stock on the date immediately preceding the date of the subscription notice.

C = Warrant Exercise Price then in effect at the time of such exercise.

The "fair market value" of the Common Stock shall be the last closing trade price for such security on the Principal Market (as defined below) as reported by Bloomberg Financial Markets ("Bloomberg"), or if the Principal Market begins to operate on an extended hours basis, and does not designate the closing trade price, then the last trade price at 4:00 p.m. Eastern Time as reported by Bloomberg, or, if the foregoing do not apply, the last closing trade price of such security on a National Securities Exchange, in the Over-the-Counter market, on the electronic Bulletin Board for such security as reported by Bloomberg, or, if no last closing trade price is reported for such security by Bloomberg, the last closing ask price of such security as reported by Bloomberg, the average of the lowest ask price and lowest bid price of any market makers for such security as reported in the "pink sheets" by the National Quotation Bureau, Inc. If the "fair market value" cannot be calculated for such security on such date on any of the foregoing bases, the "fair market value" of such security on such date shall be the fair market value as mutually determined by the Company and the Holder.

SECTION 8. Successors. All the covenants and provisions of this Warrant by or for the benefit of the Company or the Holder hereof shall bind and inure to the benefit of their respective permitted successors and assigns hereunder.



Lorraine Christine Hoffman, Esq.
Assistant Staff Counsel
The Florida Bar
File No. 2003-51, 109(15C)

SECTION 9. *Applicable Law.* This Warrant shall be deemed to be a contract made under and construed in accordance with the laws of the State of Florida, without giving effect to any conflicts of laws principles thereof.

SECTION 10. *Benefits.* This Warrant shall not be construed to give to any person or corporation other than the Company and the Holder hereof any legal or equitable right, remedy or claim under this Warrant, and this Warrant shall be for the sole and exclusive benefit of the Company and the Holder hereof.

SECTION 11. *Transferability.* No transfer of this Warrant shall be effective unless and until registered on the books of the Company maintained for such purpose, and the Company may treat the registered Holder as the absolute owner of this Warrant for all purposes and the person entitled to exercise the rights represented hereby. No such transfer of this Warrant shall be effective unless the Warrant Shares issuable upon exercise of this Warrant have been registered under the Securities Act or unless the Holder requesting such transfer provides the Company with an opinion of counsel in form reasonably satisfactory to the Company that no such registration statement in respect of such transfer is required under the Securities Act or any rule or regulation promulgated thereunder or any applicable state securities laws. Any transferee of this Warrant, by acceptance thereof, agrees to be bound by all of the terms and conditions of this Warrant.

SECTION 11. *Investment Representation and Legend.* The Holder, by acceptance of this Warrant, represents and warrants to the Company that the Holder is acquiring this Warrant, and unless at the time of exercise a registration statement under the Securities Act is effective with respect to such shares, upon the exercise hereof the Holder will acquire the Warrant Shares issuable upon such exercise, for investment purposes only and not with a view towards the resale or other distribution thereof.

The Holder, by acceptance of this Warrant, agrees that the Company may affix, unless the Warrant Shares issuable upon exercise of this Warrant are registered at the time of exercise, the following legend to certificates for Warrant Shares upon the exercise of this Warrant:

THE SECURITIES REPRESENTED BY THIS CERTIFICATE HAVE NOT BEEN REGISTERED UNDER THE SECURITIES ACT OF 1933 (THE "SECURITIES ACT"), AND HAVE NOT BEEN REGISTERED UNDER ANY STATE SECURITIES LAW, AND MAY NOT BE OFFERED, SOLD, TRANSFERRED, ENCUMBERED OR OTHERWISE DISPOSED OF UNLESS THERE IS AN EFFECTIVE REGISTRATION STATEMENT UNDER THE SECURITIES ACT AND ANY APPLICABLE STATE SECURITIES LAWS RELATING THERETO OR UNLESS, IN THE OPINION OF COUNSEL ACCEPTABLE TO THE COMPANY, SUCH REGISTRATION IS NOT REQUIRED.

- 7 -



Lorraine Christine Hoffman, Esq.
Assistant Staff Counsel
The Florida Bar
File No. 2003-51, 109(15C)

**IN WITNESS WHEREOF, the Company has duly authorized the issuance of this
Warrant as of March 21, 2001.**

Iviewit Holdings, Inc.

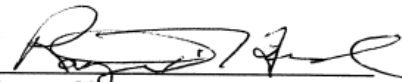
By: 
Raymond T. Hersh
Vice President Finance/CFO



Lorraine Christine Hoffman, Esq.
Assistant Staff Counsel
The Florida Bar
File No. 2003-51, 109(15C)

SCHEDULE A

Iviewit Holdings, Inc.

ELECTION TO PURCHASE FORM

**Iviewit Holdings, Inc.
2255 Glades Road
Suite 337 West
Boca Raton, Florida 33431**

The undersigned hereby irrevocably elects to exercise the right of purchase represented by the attached Warrant for, and to purchase thereunder, ____ of the Warrant Shares provided for therein (originally, ____ of the ____ Warrant Shares, and as presently adjusted pursuant to Section 3 thereof, _____ Warrant Shares). The undersigned requests that a certificate for such Warrant Shares be issued in the name of:

**(Please Print Name, Address, and
Social Security or Tax Identification Number)**

and that such certificate be delivered to _____, whose
address is _____.

Dated: _____, _____.

Name of Holder: _____

Address: _____

Signature: _____

**(signature must conform in
all respects to the name of the
Holder as specified on the face
of the Warrant Certificate)**

Holder's Social
Security/Tax ID Number: _____



Lorraine Christine Hoffman, Esq.
Assistant Staff Counsel
The Florida Bar
File No. 2003-51, 109(15C)

Tiedemann/Prolow Subscription Agreement

This document authored by Proskauer Rose's Donald "Rocky" Thompson has problems in that none of the documents that appear to be sent to Mr. Craig Smith were ever sent and the Company has no records or the investor. The subscription agreement is executed days before Mr. Utley was fired when all his signatory powers had been revoked by the Board. The prior documents you can see were dated by other people at various times and did not truly accompany Mr. Thompson's letter. The letter is dated March 2001 and it has a signature from Mr. Utley that is dated April 2001 that was sent with it?



Lorraine Christine Hoffman, Esq.
Assistant Staff Counsel
The Florida Bar
File No. 2003-51, 109(15C)

PROSKAUER ROSE LLP

2255 Glades Road
Suite 340 West
Boca Raton, FL 33431-7360
Telephone 561.241.7400
Elsewhere in Florida
800.432.7746
Fax 561.241.7145

NEW YORK
LOS ANGELES
WASHINGTON
NEWARK
PARIS

Donald E. "Rocky" Thompson, II
Attorney at Law

dthompson@proskauer.com

March 20, 2001

VIA FED EX

Mr. Craig Smith
Tiedemann/Prolow, LLC
535 Madison Avenue
37th Floor
New York, NY 10022

Re: Subscription Documentation

Dear Craig:

At Ray Hersh's request, please find enclosed a complete set of the Subscription Documentation, including the form of Warrant and form of Promissory Note, relating to your firm's investment of \$345,000 in iviewit. Please sign the Subscription Agreement and fill out the questionnaire, which is included as Exhibit "D", and return the materials to Ray Hersh's attention at iviewit. Ray will coordinate countersignature by iviewit and the issuance of the actual Note and Warrants relating to your investment. Please call either me or Ray if you have any questions with regard to the enclosed or the foregoing.

Best regards,

Donald E. Thompson, II

DET/jlm
Enclosure

cc: Mr. Ray Hersh
Christopher C. Wheeler, Esq.

0785/40017-001 BRLIB1/294515 v1

03/20/01 05:18 PM (111111)



Lorraine Christine Hoffman, Esq.
Assistant Staff Counsel
The Florida Bar
File No. 2003-51, 109(15C)

iviewit HOLDINGS, INC.
SUBSCRIPTION AGREEMENT

iviewit Holdings, Inc., a Delaware corporation (the "Company/iviewit"), and Tiedemann/Prowell LLC (the "Purchaser") hereby agree as follows: *CH*

1. **Offering.** The Company is offering (the "Offering") to Purchaser one (1) Unit consisting of (i) a \$345,000 principal amount convertible promissory note (the "Investor Note") and (ii) warrants to purchase One Thousand Seven Hundred Eighty (1,780) shares of the Company's Class B Non-Voting Common Stock at \$155.00 per share ("Warrants" and together with the Investor Note and the Class B Non-Voting Common Stock (the "Class B Common Stock") issuable upon conversion of the Investor Note or upon exercise of any Warrants, the "Unit"). All terms not otherwise defined herein shall have the same meaning as defined in the Form of Convertible Investor Note and the Form of Warrant, attached to this Subscription Agreement (this "Agreement") as Exhibit "A" (Form of Convertible Investor Note) and Exhibit "B" (Form of Warrant), respectively.

2. **Sale and Purchase of the Unit.** Subject to the terms and conditions hereof, the Purchaser irrevocably subscribes for one (1) Unit consisting of (i) a \$345,000 principal amount convertible promissory note and (ii) warrants to purchase up to 1,780 shares of the Class B Non-Voting Common Stock of the Company at \$155.00 per share, for a total purchase price of \$345,000 (the "Purchase Price"). The Purchaser acknowledges that prior to the execution hereof, the books and records of the Company, including financial information, have been made available and continue to be available for inspection by the Purchaser at the office of the Company.

3. **Payment by Purchaser.** Simultaneous with the execution of this Agreement, the Purchaser shall make payment for the Unit by delivering to the Company the Purchase Price in the form of a cashier's check, money order or other immediately available funds (made payable to ["iviewit Holdings, Inc."]), along with a fully executed Subscription Agreement.

4. **Acceptance of Subscription.** It is understood and agreed that the Company shall have the right, in its sole discretion, to accept or reject this subscription, in whole or in part, and that same shall be deemed to be accepted by the Company only when it is signed by the Company. This subscription may not be terminated or revoked by the Purchaser, except as provided hereafter. In the event this subscription is rejected by the Company, the consideration for this subscription will be returned promptly to the Purchaser without interest and without deduction for any expenses.

5. **Closing.** Subject to any rights of rescission, the closing of the sale and purchase described in Section 2 hereof (the "Closing") shall occur upon the Company's acceptance of Purchaser's subscription to purchase the Unit. The Company may reject Purchaser's subscription, in whole or in part, in its sole discretion and for any reason (or for no reason). Investments are not



Lorraine Christine Hoffman, Esq.
Assistant Staff Counsel
The Florida Bar
File No. 2003-51, 109(15C)

binding on the Company until accepted by the Company. The Company will refuse any subscriptions by giving written notice to the Purchaser by personal delivery or first-class mail.

6. Representations and Warranties by the Company and Purchaser.

6.1 The Company represents and warrants that it is a corporation validly existing and in good standing under the laws of the State of Delaware with the authority to issue and sell the Unit and to carry out the provisions hereof.

6.2 Purchaser represents, warrants and covenants with the Company and to each officer, director, principal, member, controlling person, employee and agent of the Company that Purchaser is a "accredited investor" as such term is defined in Rule 501 of the Securities Act of 1993, as amended (the "Act") and that:

(a) Investment Suitability. The Purchaser has such knowledge and experience in financial and business matters as to be capable of evaluating the merits and risks of an investment in the Unit;

(b) Degree of Risk. The Purchaser recognizes that the Purchaser's investment in the Unit involves a high degree of risk which may result in the loss of a portion of or the total amount of the Purchaser's investment. The Purchaser acknowledges that the Purchaser has carefully considered all risks incident to the purchase of the Unit, including without limitation, those risks set forth on Exhibit "C" attached hereto, and that the Purchaser has been advised and is fully aware that the business of the Company is highly speculative and involves a high degree of risk.

(c) Information True and Correct. All the information that the Purchaser has furnished to the Company, including without limitation, the information set forth in the Confidential Offeree-Purchaser Questionnaire attached as Exhibit "D" hereto, or which is set forth in this Agreement, is correct and complete as of the date of this Agreement and, if there should be any material change in such information prior to the Closing, Purchaser will immediately furnish the revised and corrected information to the Company.

(d) Applicable Securities Laws. The Purchaser intends that only the state securities laws of the state listed in the residential address of the Purchaser below, together with the federal securities laws, govern this transaction.

(e) Relationship to the Company. Purchaser or its affiliates has a preexisting personal or business relationship with the Company or its respective officers, directors or controlling persons. By reason of Purchaser's business or financial experience, or the business or financial experience of his or her professional advisor who is unaffiliated with and who is not compensated by the Company or any affiliate or selling agent of the Company, directly or indirectly, Purchaser has the capacity and has taken all steps necessary to protect his, her or its own interests in connection with an investment in the Unit. Purchaser has had access to and has been provided with all information, including financial information as the Purchaser may require, has had the



Lorraine Christine Hoffman, Esq.
Assistant Staff Counsel
The Florida Bar
File No. 2003-51, 109(15C)

opportunity to obtain any additional information necessary to verify the accuracy of the information contained in such documents and to evaluate the merits and risks of the investment, and has been given the opportunity to meet with officials of the Company and to have said officials answer any questions and the terms and conditions of this particular investment, and all such questions have been answered to the Purchaser's full satisfaction. In reaching the conclusion that the Purchaser desires to acquire the Unit, the Purchaser has carefully evaluated the Purchaser's financial resources and investments and acknowledges that the Purchaser is able to bear the economic risks of this investment.

(f) Purchaser's Liquidity. The Purchaser has adequate means of providing for his, her or its current needs and contingencies and has no need for liquidity in connection with the investment contemplated herein. Purchaser acknowledges that he, she or it must bear the economic risk of investment in the Unit for an indefinite period of time, and that he, she or it could bear a loss of his, her or its entire investment in the Unit without materially impairing his, her or its financial wherewithal. Purchaser's overall commitment to investments which are not readily marketable is not disproportionate to the net worth of the Purchaser, and the Purchaser's investment in the Unit will not cause such overall commitment to become excessive.

(g) Restrictions on Transfer. Purchaser acknowledges and understands that neither the Unit nor any component thereof has been registered under the Act or under any state securities laws and agrees that neither the Unit nor any component thereof can be resold unless it is subsequently registered under the Act and pertinent state securities acts unless an exemption from such registration is available; that the Purchaser agrees not to resell or otherwise dispose of all or any part of the Unit (or any securities into which the Investor Note may be convertible or the Warrants may be exercisable), except as permitted by law; and that there is no assurance and it is unlikely that Rule 144 under the Act will be available as a basis for exemption from registration of the Unit (or any securities into which the Investor Note may be convertible or the Warrants may be exercisable) in the foreseeable future.

(h) Nondistributive Intent. Purchaser understands that the exemption from registration under the Act upon which the Unit is being offered depends upon, among other things, the bona fide nature of Purchaser's nondistributive intent with respect to the Unit (or any securities into which the Investor Note may be convertible or the Warrants may be exercisable) as expressed herein. The Purchaser is purchasing the Unit for investment for the account of the Purchaser, not for the account of any other person, and not with any present intention to resell or otherwise distribute the Unit (or any securities into which the Investor Note may be convertible or the Warrants may be exercisable).

(i) Information. The information contained on the signature page hereof and in the Confidential Offeree-Purchaser Questionnaire attached as Exhibit "D" hereto is true and correct. The Purchaser will provide to the Company such additional information as may be reasonably requested by the Company to enable it to satisfy itself as to the knowledge and experience of the Purchaser and the Purchaser's ability to bear the economic risk of an investment in the Unit.



Lorraine Christine Hoffman, Esq.
Assistant Staff Counsel
The Florida Bar
File No. 2003-51, 109(15C)

(j) Residency. The Purchaser is incorporated in the state set forth on page 7 hereof and its business is conducted in the state set forth on page 7 hereof.

(k) Rescission Right for Florida Residents. Purchaser hereby intends that his, her or its signature hereon shall constitute an irrevocable subscription for the dollar amount of Unit specified herein. Notwithstanding Section 2 and the prior sentence, the Purchaser, if a Florida resident, shall have the right, pursuant to Section 517.061(11)(a)(5) of the Florida Statutes, at any time within three (3) days after the Purchaser first tenders the Purchase Price or the date of Purchaser's execution of this Agreement, whichever is later, to notify the Company, pursuant to the provisions of Section 9, of the Purchaser's intent to cancel this Agreement. In such event, this Agreement shall be canceled and of no further force or effect, and the Company shall promptly cause to be refunded to the Purchaser the Purchase Price paid by the Purchaser for the Unit, without interest or deduction.

(l) Organization: Authorization. Purchaser is a limited liability company, duly organized, validly existing and in good standing under the laws of the State of New York. Purchaser has the power and authority to execute this Agreement and perform Purchaser's obligations hereunder. The execution, delivery and performance by Purchaser of this Agreement and the transactions contemplated hereby have been approved by all requisite action on the part of Purchaser. This Agreement and the Confidential Offeree-Purchaser Questionnaire attached as Exhibit "D", along with the other documents, instruments and agreements of Purchaser executed in connection herewith have been duly executed and delivered by Purchaser and constitute valid and binding obligations of Purchaser enforceable against Purchaser in accordance with their terms, except to the extent enforcement may be limited by applicable bankruptcy, insolvency, reorganization or other laws of general application affecting creditors' rights and except as enforcement may be limited by general equitable principles.

7. Transfer of Unit.

7.1 Legend. Until the occurrence of one of the events specified in Section 7.3, any certificates representing any component of the Unit (including without limitation, the Class B Common Stock issuable upon conversion of the convertible Investor Note or upon the exercise of a Warrant) shall be stamped or otherwise imprinted with a legend substantially in the following form:

THESE SECURITIES HAVE NOT BEEN REGISTERED OR QUALIFIED UNDER THE SECURITIES ACT OF 1933, AS AMENDED, OR ANY STATE SECURITIES LAWS. NEITHER THESE SECURITIES NOR ANY INTEREST THEREIN MAY BE OFFERED, SOLD, PLEDGED, OR OTHERWISE TRANSFERRED UNLESS THESE SECURITIES ARE FIRST REGISTERED UNDER THE SECURITIES ACT OF 1933, AS AMENDED, AND/OR QUALIFIED UNDER ALL APPLICABLE STATE SECURITIES LAWS, OR UNTIL THE COMPANY SHALL HAVE RECEIVED AN OPINION OF LEGAL



Lorraine Christine Hoffman, Esq.
Assistant Staff Counsel
The Florida Bar
File No. 2003-51, 109(15C)

(j) Residency. The Purchaser is incorporated in the state set forth on page 7 hereof and its business is conducted in the state set forth on page 7 hereof.

(k) Rescission Right for Florida Residents. Purchaser hereby intends that his, her or its signature hereon shall constitute an irrevocable subscription for the dollar amount of Unit specified herein. Notwithstanding Section 2 and the prior sentence, the Purchaser, if a Florida resident, shall have the right, pursuant to Section 517.061(11)(a)(5) of the Florida Statutes, at any time within three (3) days after the Purchaser first tenders the Purchase Price or the date of Purchaser's execution of this Agreement, whichever is later, to notify the Company, pursuant to the provisions of Section 9, of the Purchaser's intent to cancel this Agreement. In such event, this Agreement shall be canceled and of no further force or effect, and the Company shall promptly cause to be refunded to the Purchaser the Purchase Price paid by the Purchaser for the Unit, without interest or deduction.

(l) Organization: Authorization. Purchaser is a limited liability company, duly organized, validly existing and in good standing under the laws of the State of New York. Purchaser has the power and authority to execute this Agreement and perform Purchaser's obligations hereunder. The execution, delivery and performance by Purchaser of this Agreement and the transactions contemplated hereby have been approved by all requisite action on the part of Purchaser. This Agreement and the Confidential Offeree-Purchaser Questionnaire attached as Exhibit "D", along with the other documents, instruments and agreements of Purchaser executed in connection herewith have been duly executed and delivered by Purchaser and constitute valid and binding obligations of Purchaser enforceable against Purchaser in accordance with their terms, except to the extent enforcement may be limited by applicable bankruptcy, insolvency, reorganization or other laws of general application affecting creditors' rights and except as enforcement may be limited by general equitable principles.

7. Transfer of Unit.

7.1 Legend. Until the occurrence of one of the events specified in Section 7.3, any certificates representing any component of the Unit (including without limitation, the Class B Common Stock issuable upon conversion of the convertible Investor Note or upon the exercise of a Warrant) shall be stamped or otherwise imprinted with a legend substantially in the following form:

THESE SECURITIES HAVE NOT BEEN REGISTERED OR QUALIFIED UNDER THE SECURITIES ACT OF 1933, AS AMENDED, OR ANY STATE SECURITIES LAWS. NEITHER THESE SECURITIES NOR ANY INTEREST THEREIN MAY BE OFFERED, SOLD, PLEDGED, OR OTHERWISE TRANSFERRED UNLESS THESE SECURITIES ARE FIRST REGISTERED UNDER THE SECURITIES ACT OF 1933, AS AMENDED, AND/OR QUALIFIED UNDER ALL APPLICABLE STATE SECURITIES LAWS, OR UNTIL THE COMPANY SHALL HAVE RECEIVED AN OPINION OF LEGAL



Lorraine Christine Hoffman, Esq.
Assistant Staff Counsel
The Florida Bar
File No. 2003-51, 109(15C)

satisfy such indemnity obligation as a set-off, without limiting the right of the Company to proceed in any other legal, equitable or contractual remedy directly against Purchaser for the indemnity obligation.

9. Notices. All notices, requests, consents and other communications hereunder shall be in writing (including telex, telefax and other telegraphic communication) and shall be (as elected by the person giving such notice) delivered by messenger or courier service, or mailed first-class postage prepaid registered or certified mail:

(a) If to any holder of the Unit, addressed to such holder at the address set forth below or at the Purchaser or holder's address as shown on the books of the Company or the Purchaser or holder's agent or to such other address as may from time to time be furnished to the Company in writing by any such holder.

(b) If to the Company, addressed to the Company at 2255 Glades Road, Suite 337W, Boca Raton, Florida 33431, Attn: Brian G. Utley, President, or at such other address as may from time to time be furnished to the Purchaser in writing by the Company.

Each such notice shall be deemed delivered and received: (i) on the date delivered if by personal delivery; (ii) on the date of transmission with confirmed answer back if by telex, telefax or other telegraphic method; and (iii) on the date upon which the return receipt is signed or delivery is refused or the notice is designated by the postal authorities as not deliverable, as the case may be, if mailed.

10. Miscellaneous Provisions. This Agreement represents the entire subject matter hereof, and supersedes all other negotiations, understandings and representations (if any) made by and between such parties. All of the terms and provisions of this Agreement, whether so expressed or not, shall be binding upon, inure to the benefit of, and be enforceable by the parties and their respective administrators, personal and other legal representatives, heirs, successors and permitted assigns.

The headings contained in this Agreement are for convenience of reference only, and shall not limit or otherwise affect in any way the meaning or interpretation of this Agreement.

If any part of this Agreement or any other agreement entered into pursuant hereto is contrary to, prohibited by or deemed invalid under applicable law or regulation, such provision shall be inapplicable and deemed omitted to the extent so contrary, prohibited or invalid, but the remainder hereof shall not be invalidated thereby and shall be given full force and effect so far as possible. All agreements, covenants, representations and warranties made herein or otherwise made in writing by any party pursuant hereto shall survive the execution and delivery of this Agreement and the consummation of the transactions contemplated hereby. It is expressly understood that Sections 6, 7, 8, 9 and 10 shall survive the Closing and any subsequent sale or other transfer by the Purchaser of any portion of the Unit (or any securities underlying the Unit).



Lorraine Christine Hoffman, Esq.
 Assistant Staff Counsel
 The Florida Bar
 File No. 2003-51, 109(15C)

This Agreement and all transactions contemplated by this Agreement shall be governed by, and construed and enforced in accordance with, the laws of the State of Florida without regard to principles of conflicts of laws. The parties acknowledge that a substantial portion of negotiations, anticipated performance and execution of this Agreement occurred or shall occur in Palm Beach County, Florida, and that, therefore, without limiting the jurisdiction or venue of any other federal or state courts, each of the parties irrevocably and unconditionally: (a) agrees that any suit, action or legal proceeding arising out of or relating to this Agreement may be brought in the courts of record of the State of Florida in Palm Beach County or the District Court of the United States, Southern District of Florida; (b) consents to the jurisdiction of each such court in any suit, action or proceeding; (c) waives any objection which that party may have to the laying of venue of any such suit, action or proceeding in any of such courts; and (d) agrees that service of any court paper may be effected on such party by mail, as provided in this Agreement, or in such other manner as may be provided under applicable laws or court rules in said state.

11. Counterparts. This Agreement may be executed in one or more counterparts, each of which shall be deemed an original, but all of which together shall constitute one and the same instrument.

Print or Type Below

Tiedemann Polow, LLC
 Name of Purchaser

535 Madison Avenue
NY, NY 10022
 Business Address of Purchaser

Amount Subscribed for by Purchaser:

\$345,000.00

[THE REMAINDER OF THIS PAGE IS INTENTIONALLY LEFT BLANK]



Lorraine Christine Hoffman, Esq.
Assistant Staff Counsel
The Florida Bar
File No. 2003-51, 109(15C)

IN WITNESS WHEREOF, the Purchaser hereby executes this Agreement this 21st day of March, 2001.

Purchaser:
TIEDEMANN/PROLOW ~~LLC~~ *LLC*

By: *Craig L. Smith*
Name: Craig L. Smith
Its: Member

AGREED as to \$345,000 for the Unit this 18th day of April, 2001.

iviewit Holdings, Inc.

By: *Brian G. Utley*
Name: Brian G. Utley
Its: President



Lorraine Christine Hoffman, Esq.
 Assistant Staff Counsel
 The Florida Bar
 File No. 2003-51, 109(15C)

Exhibit B – Brian Utley Employment Agreement and Non-Compete

7-47
BIN 1

EXECUTIVE EMPLOYMENT AGREEMENT

EXECUTIVE EMPLOYMENT AGREEMENT ("Agreement") made as of the 3rd day of August, 1999, by and between iviewit.com LLC, a Delaware limited liability company with an address at 2255 Glades Road, Suite 337 West, Boca Raton, Florida 33431 (the "Company"), and BRIAN G. UTLEY with an address at 1930 Southwest 8th Street, Boca Raton, Florida 33486 (the "Executive").

WHEREAS, the Company desires to employ Executive and to ensure the continued availability to the Company of the Executive's services, and the Executive is willing to accept such employment and render such services, all upon and subject to the terms and conditions contained in this Agreement;

NOW, THEREFORE, the Company and the Executive hereby agree as follows with respect to the Executive's employment with the Company:

1. **Employment.** The Company shall employ the Executive and the Executive shall be employed with the Company, on the terms and conditions hereinafter set forth, for a period commencing as of the date hereof (the "Effective Date") and ending three (3) years after the date hereof, unless sooner terminated pursuant to the provisions of this Agreement. Such period of employment shall be automatically extended for successive one-year terms of employment, unless either the Company or the Executive notifies the other in writing at least ninety (90) days prior to the end of the then current term that it or he does not intend to renew such employment, in which case such employment will expire at the end of the then current term. All references herein to the "Employment Period" shall refer to both the initial term and any such successive renewal terms. During his employment hereunder, the Executive shall be the President and Chief Operating Officer of each of the Company, uvview.com, Inc., a Delaware corporation ("uvview") and iviewit LLC, a Delaware limited liability company ("iviewit") (uvview and iviewit are collectively referred to herein as the "Affiliates").

2. **Exclusive Efforts.** The Executive shall devote his full time, best efforts, skills and attention to the business and affairs of the Company and the Affiliates, shall serve the Company and the Affiliates faithfully and competently and shall at all times act in the Company's and the Affiliates' best interests. The services to be rendered by Executive during the Employment Period shall be the normal duties of a person employed as a President and Chief Operating Officer by a corporation in the Company's business, subject at all times to the direction and control of the Company's Board of Directors (the "Board").

3. **Compensation and Benefits.** The Company shall pay to the Executive, and the Executive agrees to accept, compensation as follows:



Lorraine Christine Hoffman, Esq.
Assistant Staff Counsel
The Florida Bar
File No. 2003-51, 109(15C)

(a) Subject to the provisions of Section 3(b) below, the Company shall pay to the Executive, and the Executive agrees to accept, an initial base compensation of Fifty Thousand Dollars (\$50,000) per year (the "Initial Salary"). All compensation payable to Executive hereunder shall be payable in accordance with the normal payroll policies of the Company and shall be subject to all usual and customary payroll deductions, including all applicable withholding taxes.

(b) The Initial Salary shall be increased by: (i) Fifty Thousand Dollars (\$50,000) to One Hundred Thousand Dollars (\$100,000) per year on September 3, 1999 (the "Salary Increase Date"), (ii) an additional Fifty Thousand Dollars (\$50,000) to One Hundred Fifty Thousand Dollars (\$150,000) per year beginning six (6) months following the Salary Increase Date, and (iii) an additional One Hundred Thousand Dollars (\$100,000) to Two Hundred Fifty Thousand Dollars (\$250,000) per year beginning twelve (12) months following the Salary Increase Date.

(c) In addition to the compensation provided for in Sections 3(a) and 3(b), on the Effective Date, the Company shall cause uvview to issue in the Executive's name seventeen thousand one hundred thirty-eight (17,138) shares of uvview's Class B Common Stock (the "Initial Shares"), for the consideration of \$.05 per share. The Executive shall be entitled to receive up to seventeen thousand one hundred thirty-eight (17,138) additional shares of uvview's Class B Common Stock at future dates during the Employment Period as determined in the Board's sole discretion, subject to Executive's fulfillment of certain performance standards established, from time to time, by the Board.

(d) The compensation provided for in Sections 3(a) and 3(b) shall be in addition to any pension or retirement benefits, hospital and medical, disability, and other benefits, if any, made generally available by the Company, in its sole discretion, to its executive officers.

(e) Executive acknowledges that it is the Company's intent to purchase a "key-man" life insurance policy on the life of Executive for the benefit of the Company (the "Insurance Policy"). Executive agrees to cooperate fully in the acquisition, modification, amendment or supplement of the Insurance Policy, including submitting to any physical examination and providing any medical information as may be required by the insurer. In the event Executive dies within the Employment Period, the Personal Representative(s) (the "Personal Representatives") of Executive's estate (the "Estate") shall, at the Personal Representatives' sole discretion, elect to surrender to the Company all right, title and interest in and to the Initial Shares and obtain payment from the Company of the proceeds (the "Proceeds") of the Insurance Policy (the "Election"). The Election shall be in writing and delivered to and received by the Company at its then corporate headquarters within four (4) months from the date of Executive's death. Within seven (7) business days after the Company's dated receipt of the Election, if the Personal Representatives elect to receive the Proceeds, the Personal Representatives shall deliver the Initial Shares (along with executed stock powers) to the Company at its then corporate headquarters at which time the Company shall issue a certified or cashier's check payable to the Estate for the full amount of the Proceeds; provided, however, that if at the time of the Election the Company has not received the Proceeds, and if the Personal Representatives elect to receive the Proceeds, the



Lorraine Christine Hoffman, Esq.
Assistant Staff Counsel
The Florida Bar
File No. 2003-51, 109(15C)

Company shall notify the Personal Representatives at such time as it receives the Proceeds, and, upon receipt of such notification, the Personal Representatives shall then be required to tender the Initial Shares to the Company at its corporate headquarters within seven (7) days of said notification, upon which the Company shall comply with the provisions of this Section regarding remittance of the Proceeds. If the Personal Representatives fail to comply with the provisions of the preceding sentence, the Company shall, at its sole discretion, notify the Personal Representatives as to whether it will demand the surrender of the Initial Shares (and make the corresponding payment of the insurance proceeds) no later than nine (9) months from the date of Executive's death or the deadline for filing Executive's Federal estate tax return, whichever occurs later.

(f) The Executive shall be entitled to four (4) weeks paid vacation per year. Such vacation time allowance shall not cumulatively accrue, and any unused vacation time for each year of the Employment Period shall be forfeited by Executive if not used during each year.

4. **Business Expenses.** The Executive shall be reimbursed for all usual and reasonable expenses incurred on behalf of the Company and the Affiliates, as applicable, as approved by the Board, in accordance with Company practices and procedures, provided that:

(a) Each such expenditure is of a nature qualifying it as a proper deduction on the federal and state income tax returns of the Company and any of the Affiliates, as applicable, as a business expense and not as deductible compensation to Executive; and

(b) Executive furnishes the Company with adequate documentary evidence required by federal and state statutes and regulations for the substantiation of such expenditures as deductible business expenses of the Company and of any of the Affiliates, as applicable, and not as deductible compensation to Executive.

Executive agrees that, if at any time, any payment made to Executive by the Company as a business expense reimbursement shall be disallowed in whole or in part as a deductible expense to the Company or any of the Affiliates, as applicable, by the appropriate taxing authorities, Executive shall reimburse the Company or any of the Affiliates, as applicable, to the full extent of such disallowance.

5. **Termination.**

(a) This Agreement may be immediately terminated by the Company at any time during the Employment Period for cause. In such an event of termination, the Company shall be obligated only to continue to pay to Executive his compensation, if any, earned up to the effective date of termination. "Cause" for purposes hereof shall mean (i) a breach of any of the provisions of this Agreement by Executive, (ii) conviction for any criminal offense involving a felony or (iii) willful misconduct, gross negligence or malfeasance.

(b) Except as otherwise provided herein, this Agreement and the obligations of the Company hereunder will terminate upon the death or at the Company's option, the disability



Lorraine Christine Hoffman, Esq.
Assistant Staff Counsel
The Florida Bar
File No. 2003-51, 109(15C)

of the Executive. For purposes of this Section 5(b), "disability" shall mean that for a period of four consecutive months or six months in any 12-month period the Executive is incapable of substantially fulfilling the duties set forth in Section 2 or hereafter assigned to him because of physical, mental or emotional incapacity resulting from injury, sickness or disease as determined by an independent physician selected by the Company. Upon any such termination upon death or disability, the Company will pay the Executive or his legal representative, as the case may be, his compensation (including the Initial Shares issuable to Executive pursuant to Section 3(c) above), if any, earned through the date of such termination of employment.

6. Restrictive Covenants.

(a) Executive acknowledges that his services and responsibilities are unique in character and are of particular significance to the Company and to the Affiliates, that the Company and its Affiliates are competitive businesses and Executive's continued and exclusive service to the Company and the Affiliates under this Agreement is of a high degree of importance to the Company and the Affiliates. Therefore, during the Employment Period and for a period of two (2) years thereafter (the "Noncompete Period"), Executive shall not, directly or indirectly, as owner, partner, joint venturer, employee, broker, agent, corporate officer, principal, licensor, shareholder (unless as owner of no more than one percent (1%) of the issued and outstanding capital stock of such entity if such stock is traded on a major securities exchange) or in any other capacity whatsoever, engage in or have any connection with any business which is "competitive" with the Company or any of its Affiliates, and which operates anywhere in the "Restricted Territory" (as hereinafter defined). For purposes of this Agreement, a business will be deemed to be "competitive" with the Company and its Affiliates if it is engaged in the same business that the Company or any of its Affiliates are engaged in, or contemplates engaging in, including, but not limited to, any business engaged in whole or in part in developing, marketing, and implementing technology that allows products and services to be advertised and marketed via the internet. In recognition of the world wide access afforded by the internet, the parties agree that for purposes of this Agreement, "Restricted Territory" shall mean worldwide.

(b) During the Noncompete Period, the Executive shall not:

(i) directly or indirectly, by initiating contact or otherwise, induce, influence, combine or conspire with, or attempt to induce, influence, combine or conspire with, any of the officers, employees or agents of the Company to terminate his, her or its employment or relationship with or to compete against the Company or any of the Affiliates;

(ii) directly or indirectly, by initiating contact or otherwise, divert or attempt to divert any or all of any customers' or suppliers' business with the Company or any of the Affiliates.

(c) If, in any judicial proceedings, a court shall refuse to enforce any of the covenants included in this Section 6, then such unenforceable covenant shall be amended to relate to such lesser scope, period or geographical area as shall be enforceable. In the event the



Lorraine Christine Hoffman, Esq.
Assistant Staff Counsel
The Florida Bar
File No. 2003-51, 109(15C)

Company or any of its Affiliates should bring any legal action or other proceeding against Executive for enforcement of this Agreement, the calculation of the Noncompete Period shall not include the period of time commencing with the filing of legal action or other proceeding to enforce this Agreement through the date of final judgment or final resolution, including all appeals, if any, of such legal action or other proceeding unless the Company and the Affiliates are receiving the practical benefits of this Section 6 during such time. The existence of any claim or cause of action by Executive against the Company or any of the Affiliates predicated on this Agreement or otherwise shall not constitute a defense to the enforcement by the Company or any of the Affiliates of these covenants.

(d) Executive hereby acknowledges that the restrictions on his activity as contained in this Agreement are required for the Company's reasonable protection and are a material inducement to the Company to enter into this Agreement. Executive hereby agrees that in the event of the violation by him of any of the provisions of this Agreement, the Company and its Affiliates and its or their permitted assigns (which are intended third-party beneficiaries of these covenants) will be entitled to institute and prosecute proceedings at law or in equity to obtain damages with respect to such violation, to enforce the specific performance of this Agreement by Executive, to enjoin Executive from engaging in any activity in violation hereof, or any combination of the foregoing remedies together with any other remedies available at law or in equity.

7. Treatment and Ownership of Confidential Information.

(a) The parties hereto acknowledge that Executive shall or may be making use of, acquiring and adding to Confidential Information (as that term is defined in subparagraph (b) below). Executive covenants and agrees that during the Employment Period and at all times thereafter he shall not, except with the prior written consent of the Company, or except if he is acting during the Employment Period solely for the benefit of the Company or any of the Affiliates in connection with the Company's or any of the Affiliates' business and in accordance with the Company's business practices and policies, at any time, disclose, divulge, report, transfer or use, for any purposes whatsoever, any of such Confidential Information, including Confidential Information obtained, used, acquired or added by, or disclosed to, Executive prior to the date of this Agreement.

(b) For purposes of this Agreement, the term "Confidential Information" shall mean all of the following materials and information which Executive receives, conceives or develops or has received, conceived or developed, in whole or in part, in connection with Executive's employment with the Company:

The Company's and the Affiliates' materials and information (regardless of the form of such information, including without limitation, in writing, electronic, computerized or other recorded form, oral or visual) concerning, or related in any way to, the Company and the Affiliates' or its or their businesses, including without limitation: (i) the contents of any Business Plan, projections or financial or credit information or data relating to the Company or any of its Affiliates; (ii) the contents of any manuals or written materials of the Company or any of its Affiliates; (iii) the



Lorraine Christine Hoffman, Esq.
Assistant Staff Counsel
The Florida Bar
File No. 2003-51, 109(15C)

names and records of actual or prospective clients, customers, suppliers, lenders, financing sources, or related persons; (iv) the terms of various agreements between the Company or the Affiliates and third parties; (v) any data or database, or other information compiled or developed by the Company or its Affiliates; (vi) any computer programs and listings, source codes and/or object codes, file structures, trademarks, trade secrets, patents, patent designs, patent applications, copyrights, forms, procedures, processes, training methods, developments, technical information, marketing activities and procedures and methods of operation, together with any other information, data, know-how or knowledge of a confidential or proprietary nature; and (vii) any information of a type described above derived or obtained from the internet or any website of the Company or its Affiliates, including without limitation, the file structure relating to such website or the content of such website.

(c) Executive covenants and agrees that all right, title and interest in any Confidential Information shall be and shall remain the exclusive property of the Company and the Affiliates, as applicable. Executive agrees to promptly disclose to the Company all Confidential Information developed in whole or in part by Executive within the scope of this Agreement and to assign to the Company or any of the Affiliates, as the Company determines in its sole discretion, any right, title or interest Executive may have in such Confidential Information. Executive agrees to turn over to the Company all physical manifestations of the Confidential Information in his possession or under his control at the request of the Company.

8. Inventions.

(a) Executive agrees to promptly inform and to disclose to the Company, in writing, all inventions, developments, procedures, ideas, innovations, systems, programs, techniques, processes, information, discoveries, improvements and modifications which Executive creates (collectively the "Inventions"), either alone or with others, while in the Company's employ, or while performing services for the Affiliates, whether or not during working hours, and at all times thereafter if the Inventions:

- (i) relate to the present or anticipated business of the Company or any of the Affiliates;
- (ii) relate to any actual or demonstrably anticipated research or development work of the Company or any of the Affiliates;
- (iii) result from any work performed by the Executive for the Company or any of the Affiliates or customers of either; or
- (iv) were invented utilizing the Company's or any of the Affiliates equipment, supplies, facilities, time or any information (whether or not considered Confidential Information) obtained from or useful to the Company or any of the Affiliates.



Lorraine Christine Hoffman, Esq.
Assistant Staff Counsel
The Florida Bar
File No. 2003-51, 109(15C)

(b) Assignment. All of the above-described Inventions, and all rights relating thereto, shall be assigned by virtue of this Agreement and without further action by Executive to the Company and shall be and shall remain the exclusive property of the Company.

(c) Ownership. With respect to each Invention assigned to the Company, Executive hereby grants, transfers and assigns to the Company all of his rights, title and interest, if any, in any and all written materials (including but not limited to programmed instructional material), pictorial reproductions, drawings and other graphic representations and works of similar nature upon which he may be engaged in, including rights to translation and reproductions in all forms or formats and the copyrights thereto, if any, and Executive agrees that the Company may copyright said materials in the Company's name and secure renewal, reissues and extensions of such copyrights for such periods of time as the law may permit.

(d) Executive Assistance. During the Employment Period and at all times thereafter, the Executive agrees to assist the Company and the Affiliates in obtaining patents or copyrights on any Inventions assigned to the Company that the Company or any or all of the Affiliates, in the Company's sole discretion, seeks to patent or copyright. Executive also agrees to sign all documents, and do all things necessary to obtain such patents or copyrights, to further assign them to the Company or any of the Affiliates, as applicable, and to protect the Company and the Affiliates against infringement by other parties. Executive agrees that such actions will be without compensation, but at no expense to the Executive.

(e) Attorney-in-Fact. Executive irrevocably appoints any Company-selected designee to act as his agent and attorney-in-fact to perform all acts necessary to obtain patents and/or copyrights as required by this Agreement if Executive (i) refuses to perform those acts or (ii) is unavailable, within the meaning of the United States Patent and Copyright Laws. It is expressly intended by Executive that the foregoing power of attorney is coupled with an interest.

(f) Records. Executive shall keep complete, accurate and authentic information and records on all Inventions in the manner and form reasonably requested by the Company. Such information and records, and all copies thereof, shall be the property of the Company as to any Inventions within the meaning of this Agreement. In addition, Executive agrees to promptly surrender all such original and copies of such information and records at the request of the Company.

9. Executive Representations and Warranties. The Executive represents and warrants to the Company that he is free of known physical and mental disabilities that would, with or without reasonable accommodations that would not create an undue hardship for the Company, impair his performance hereunder and he is fully empowered to enter and perform his obligations under this Agreement. Without limiting the generality of the foregoing, Executive represents and warrants that he is under no restrictive covenants to any person or entity that will be violated by his entering into and performing this Agreement. The Executive shall indemnify the Company on demand for and against any and all judgments, losses, claims, damages, expenses and costs (including without limitation all legal fees and costs, even if incident to appeals) incurred or



Lorraine Christine Hoffman, Esq.
Assistant Staff Counsel
The Florida Bar
File No. 2003-51, 109(15C)

suffered by the Company as a result of any breach by Executive of this representation and warranty.

10. **Binding Effect.** Except as herein otherwise provided, this Agreement shall inure to the benefit of and shall be binding upon the parties hereto, their personal representatives, successors, heirs and assigns.

11. **Severability.** Invalidity or unenforceability of any provision hereof shall in no way affect the validity or enforceability of any other provisions.

12. **Governing Law.** This Agreement shall be governed and construed in accordance with the laws of the State of Florida.

13. **Entire Agreement.** This Agreement and the Confidentiality Agreement dated July 9, 1999 by and between iVIEWIT, Inc. (together with its direct and indirect subsidiaries and affiliates) and Executive contains the entire understanding between the parties and this Agreement may not be changed or modified except by an Agreement in writing signed by all the parties hereto.

14. **Notice.** Any notice required or permitted to be delivered hereunder shall be deemed to be delivered when either hand delivered or deposited in the United States mail, postage prepaid, registered or certified mail, return receipt requested, addressed to the parties at the addresses first stated herein, or to such other address as either party hereto shall from time to time designate to the other party by notice in writing as provided herein.

15. **Prevailing Parties.** If any legal action or other proceeding is brought for the enforcement of this Agreement, or because of an alleged dispute, breach, default or misrepresentation in connection with any provision of this Agreement, the successful or prevailing party or parties shall be entitled to recover reasonable attorneys' fees, sales and use taxes, court costs and all expenses even if not taxable as court costs (including, without limitation, all such fees, taxes, costs and expenses incident to arbitration, appellate, bankruptcy and post-judgment proceedings), incurred in that action or proceeding, in addition to any other relief to which such party or parties may be entitled.

16. **Survival.** Notwithstanding any termination of this Agreement, the provisions of Sections 6 through 16 shall survive such termination.



Lorraine Christine Hoffman, Esq.
Assistant Staff Counsel
The Florida Bar
File No. 2003-51, 109(15C)

IN WITNESS WHEREOF, this Agreement has been duly signed by the Executive and on behalf of the Company as of the day and year first above written.

iviewit.com LLC

By: 
Eliot I. Bernstein, Vice President

BRIAN G. UTLEY

47.1
B.N.1
SU 47



Lorraine Christine Hoffman, Esq.
 Assistant Staff Counsel
 The Florida Bar
 File No. 2003-51, 109(15C)

2047
 47.5
 84

NON-COMPETITION, NON-DISCLOSURE AND PROPRIETARY RIGHTS AGREEMENT

THIS NON-COMPETITION, NON-DISCLOSURE AND PROPRIETARY RIGHTS AGREEMENT ("Agreement") is made as of the 22nd day of February, 2000, by and between iViewit Technologies, Inc., a Delaware corporation (the "Company"), whose principal place of business is 2255 Glades Road, Suite 337-W, Boca Raton, Florida 33431-7360 and Brian G. Utley, an individual whose address is 1930 South West 8th Street, Boca Raton, Florida 33486 ("Individual").

RECITALS

A. Individual has acted and continues to act as an officer and director of the Company and has become familiar with the business of developing, owning, licensing and marketing apparatuses and methods for producing enhanced digital images and video for use on the Internet and the World Wide Web (the "Business") through the Company and the Company's parent, subsidiaries and affiliates (collectively with the Company, "Company Entities").

B. The Company has provided substantial opportunities to Individual in the conduct of Individual's [profession/position] including, but not limited to, present and future earnings, access to potential and existing customers, clients and the Company's proprietary information.

NOW, THEREFORE, for good and valuable consideration, the receipt of which is hereby acknowledged by both parties, Individual agrees as follows:

1. Recitals. The above recitals are true and correct and are incorporated herein by reference.
2. Covenant Not-to-Compete/Non-Solicitation.

a. General: Duration of Covenant. The Individual covenants and agrees that during his or her employment with the Company, and for a period of two (2) years after such employment is terminated thereafter (the "Restricted Period"), Individual will not, without the prior written consent of Company, directly or indirectly, have any involvement with any business or enterprise (whether as a sole proprietor, partner, member, stockholder, director, officer, employee, consultant or in any other capacity as principal or agent, except for an interest of less than one percent (1%) of the outstanding shares of a publicly-held corporation, which is competitive to any Company Entity, whose outstanding stock is owned of record by one hundred (100) or more shareholders), which competes with any Company Entity in the "Restricted Territory", as defined below.

b. Definition of Competition. For purposes of this Agreement, competition with a Company Entity shall mean engagement or employment in or by any business or enterprise which is engaged, directly or indirectly, in whole or in part, in the same business as the Company's Business.

c. Restricted Territory. For purposes of this Agreement, and in recognition of the world-wide market for the Company's products and services and the world wide accessibility of the World Wide Web, the "Restricted Territory" shall be world wide.

d. Solicitation of Employees. During the Restricted Period, Individual shall not, directly or indirectly, induce, solicit, disrupt, influence, interfere, combine or conspire with, or attempt to induce,



Lorraine Christine Hoffman, Esq.
Assistant Staff Counsel
The Florida Bar
File No. 2003-51, 109(15C)

influence, interfere, combine or conspire with, any of the employees of, or consultants to, a Company Entity to terminate their employment or engagement with, or compete against, a Company Entity.

e. Solicitation of Accounts. During the Restricted Period, Individual shall not, directly or indirectly, solicit, interfere with or disrupt or attempt to solicit, interfere with or disrupt any present or prospective relationship, contractual or otherwise, between a Company Entity and any client, customer, supplier, financing source, sales representative or other person or entity.

3. Non-Disclosure of Confidential Information.

a. Treatment of Information. The Individual acknowledges that the Company's Confidential Information (as hereinafter defined) constitutes valuable special and unique assets of the Company, access to and knowledge of which have been (and may be in the future) provided to the Individual by virtue of the Individual's employment (or other engagement or arrangement) for and on behalf of any Company Entity. In light of the highly competitive nature of the industry in which the Business is conducted, the Individual agrees that all Confidential Information heretofore or in the future obtained by the Individual shall be considered and treated as confidential.

b. Ownership. The Individual acknowledges that, as between the Company and the Individual, the Confidential Information and any and all rights and privileges provided under the patent, trademark, copyright, trade secret and other laws of the United States, the individual states thereof, and jurisdictions foreign thereto, and the goodwill associated therewith, have been, are and at all times will be, the property of the Company.

c. Covenants. The Individual agrees that he shall: (i) hold in confidence and not disclose or make available to any third party any Confidential Information unless so authorized in writing by the Company; (ii) exercise all reasonable efforts to prevent third parties from gaining access to the Confidential Information; (iii) not use, directly or indirectly, the Confidential Information in any respect of his business, except as necessary to evaluate the information in order to perform the Individual's duties and responsibilities to the Company; (iv) restrict the disclosure or availability of the Confidential Information to those who have read and understand this Agreement and who have a need to know the information in order to achieve the purposes of this Agreement; (v) not copy or modify any Confidential Information without the prior written consent of the Company; provided, however, that such copy or modification of any Confidential Information does not include any modifications or copying which would otherwise prevent the Individual from performing his duties and responsibilities to the Company; (vi) take such other protective measures as may be reasonably necessary to preserve the confidentiality of the Confidential Information; (vii) relinquish all rights he may have in any matter, such as drawings, documents, models, samples, photographs, patterns, templates, molds, tools or prototypes, and inventions, which may contain, embody or make use of the Confidential Information; (viii) promptly deliver to the Company any such matter as the Company may direct at any time; and (ix) not retain any copies or other reproductions thereof. Individual acknowledges that he has had access to, or been provided with, Confidential Information prior to the date of this Agreement and that all such Information shall be entitled to the protections set forth in this Agreement.

d. Confidential Information Defined. The term "Confidential Information" means trade secrets, private or secret processes, methods and ideas customer lists and information concerning the Company's products, services, technologies, business records and plans, inventions, product design information, data or database, or other computer programs and listings, source code and/or subject code.



Lorraine Christine Hoffman, Esq.
Assistant Staff Counsel
The Florida Bar
File No. 2003-51, 109(15C)

copyrights, trademarks, trade secrets, patents, patent applications, patent designs, proprietary information, formulae, protocols, forms, procedures, development, technical information, know-how, show-how, marketing activities and procedures, method for operating of the Company's Business, credit and financial data concerning the Company, projections, the Company's clients and client lists, supplier lists (which lists shall not only mean one or more of the names and addresses of the clients and suppliers of the Company but it shall also encompass any and all information whatsoever regarding them, including their needs), and marketing and advertising practices and plans and information. The term "Confidential Information" shall also encompass all similar information owned or regarding any of the Company Entities.

e. Exceptions. Excluded from the Confidential Information, and therefore not subject to the provisions of this Section 3, shall be any information which: (i) at the time of disclosure, is in the public domain as evidenced by printed publications; (ii) after the disclosure, enters the public domain by way of printed publication through no fault of the Individual; (iii) the Individual can show by written documentation that the Confidential Information was in the Individual's possession at the time of disclosure and which was not acquired directly or indirectly from any Company Entity or any representative thereof (whether before or after the date of this Agreement); or (iv) the Individual can show by written documentation was acquired, after disclosure, from a third party who did not receive it from any Company Entity or any representative thereof, and who had the right to disclose the information without any obligation to hold such information confidential. Specific information shall not be deemed to be within the foregoing exceptions merely because it is embraced by more general information in the public domain. Additionally, any combination of features shall not be deemed to be within the foregoing exceptions merely because individual features are in the public domain. If the Individual intends to avail himself/herself of any of the foregoing exceptions, the Individual shall first notify the Company in writing of his/her intention to do so and the basis for claiming the exception.

4. Inventions.

a. Disclosure. The Individual agrees to promptly inform and to disclose to the Company in writing (whether patentable or not) any and all inventions, developments, procedures, ideas, innovations, systems, programs, techniques, processes, information, discoveries, improvements and modifications, industrial designs, mask works, however fixed or encoded that are suitable to be fixed, embedded or programmed in a semiconductor product (whether recordable or not) and all works of authorship (whether or not copyright protection may be obtained for it) created, conceived or developed by the Individual, either alone or with others, directly or indirectly, which meet any of the following criteria:

i. arise in whole or in part from any services rendered to, for or on behalf of any Company Entity (including without limitation, all such services relating to the period before the date of this Agreement);

ii. are created, conceived or developed by the Individual based upon, in whole or in part, any Confidential Information;

iii. relate to the present or anticipated business of any Company Entity, including without limitation, the development and commercialization of apparatuses and methods for producing enhanced digital images or digital video for display on any medium, including the Internet and world wide web, as well as any applications therefor and/or improvements thereon (the "Digital Processing and Display Technology");



Lorraine Christine Hoffman, Esq.
Assistant Staff Counsel
The Florida Bar
File No. 2003-51, 109(15C)

iv. relate to any actual or demonstrably anticipated research or development work of any of the Company Entities; or

v. were invented utilizing any of the Company Entities' equipment, supplies, facilities, time or any information (whether or not considered Confidential Information) obtained from or useful to the Company or any of the Company Entities.

All of the foregoing are collectively referred to herein as "Inventions" and individually as an "Invention". For purposes of this Agreement, the term "Inventions" shall include not only Inventions created, conceived or developed after the date of this Agreement, but also all Inventions created, conceived or developed prior to the date of this Agreement, including specifically any and all Inventions relating to the Digital Processing and Display Technology. Any item of the nature identified in this subparagraph a. which was or is created, conceived or developed at anytime prior to the date hereof through the date that is three (3) years after the last date upon which any consulting or similar services were rendered by the Individual to any Company Entity shall be conclusively presumed to be an Invention for purposes of this Agreement.

b. Assignment. All Inventions, and all rights relating thereto, shall be assigned by virtue of this Agreement and without further action by the Individual to the Company and shall be and shall remain the exclusive property of the Company. Individual shall execute any and all Assignments and/or other formal papers perfecting and/or transferring all right, title and/or interest in the name of the Company.

c. Ownership. The Company shall own title to all Inventions (including without limitation, patent applications, patents, trademarks, copyrights and trademarks). With respect to each Invention assigned to the Company, the Individual hereby grants, transfers and assigns to the Company all of his world-wide rights, title and interest, if any, in any and all written materials (including but not limited to programmed instructional material), pictorial reproductions, drawings and other graphic representations and works of similar nature upon which he may be engaged in, including rights to translation and reproductions in all forms or formats and the copyrights thereto, if any, and the Individual agrees that the Company may copyright said materials in the Company's name and secure renewal, reissues and extensions of such copyrights for such periods of time as the law may permit. Individual specifically agrees that all copyrightable material generated or developed under this Agreement shall be considered works "made for hire" (as that term is defined pursuant to the U.S. Copyright Act of 1976, as amended) and that such material shall, upon creation, be owned exclusively by Company. To the extent that any such material, under applicable law, may not be considered works made for hire, Individual hereby assigns to Company all right, title and interest in the ownership of copyright in such materials, without the necessity of any further consideration, and Company shall be entitled to obtain and hold in Company's own name all copyrights in respect of such materials. Without limiting the generality of the foregoing, Individual acknowledges that he has not been granted any license or other right to use any Invention.

d. The Individual's Assistance. The Individual agrees to assist the Company in obtaining patents or copyrights on any Inventions assigned to the Company that the Company, in its sole discretion, seeks to patent or copyright. The Individual also agrees to sign all documents (including assignments in form requested by the Company) and do all things necessary to obtain such patents or copyrights, to further assign them to the Company, and to protect the Company against infringement by other parties. The Individual_ agrees that such actions will be without compensation to the Individual.

e. Attorney-in-Fact. The Individual irrevocably appoints any Company-selected designee to act as his agent and attorney-in-fact to perform all acts necessary to obtain patents and/or copyrights as



Lorraine Christine Hoffman, Esq.
Assistant Staff Counsel
The Florida Bar
File No. 2003-51, 109(15C)

required by this Agreement if the Individual (i) refuses to perform those acts or (ii) is unavailable, within the meaning of the United States Patent and Copyright Laws. It is expressly intended by the Individual that the foregoing power of attorney is coupled with an interest.

f. Records. The Individual shall keep complete, accurate and authentic information and records on all Inventions in the manner and form reasonably requested by the Company. Such information and records, and all copies thereof, shall be the property of the Company as to any Inventions within the meaning of this Agreement and shall constitute Confidential Information. In addition, the Individual agrees to promptly surrender all such original and copies of such information and records at the request of the Company.

5. Reasonableness and Enforcement of Restrictions.

a. Reasonableness. The Individual hereby agrees that the restrictions imposed upon Individual by the provisions of this Agreement are fair and reasonable and are reasonably required for the protection of the Company. In the event that any part of this Agreement shall be held to be unenforceable or invalid, the remaining parts hereof shall nevertheless continue to be valid and enforceable as though the invalid portions were not a part hereof. The Individual acknowledges that the covenants and agreements set forth in Sections 2 through 6 hereof are and were a material inducement to the Company to (i) employ, engage, consult or otherwise use the services of, the Individual, and (ii) permit access to the Confidential Information by the Individual.

b. Enforcement. The parties hereby agree that any violation by Individual of the covenants contained in this Agreement shall cause irreparable damage to the Company for which Company will have no adequate remedy at law. In the event that the Individual breaches any of the covenants contained in this Agreement, the Individual hereby agrees and acknowledges that the Company, upon the filing of an action in a Court of competent jurisdiction, shall be immediately entitled to the issuance of an ex parte preliminary injunction enjoining the Individual from continuing any such breach. Individual acknowledges and agrees that the provisions of this Agreement, including, without limitation, the provisions of Section 2-4 may be enforced by the Company or any successor or assign of the Company. Individual agrees to indemnify and hold harmless the Company for all costs, damages, expenses and liabilities incurred by the Company or any Company Entity arising or relating to any breach of this Agreement by Individual.

6. Individual Representations. Individual hereby represents and warrants that Individual has full right and authority to perform Individual's obligations hereunder, and that Individual has neither assigned nor otherwise entered into an agreement by which Individual purports to assign or transfer any right, title, or interest to any technology or intellectual property right that would conflict with Individual's obligations under this Agreement.

7. Miscellaneous.

a. Binding Effect. Except as herein otherwise provided, this Agreement shall inure to the benefit of and shall be binding upon the parties hereto, their personal representatives, successors, heirs and assigns.

b. Severability. Invalidity or unenforceability of any provision hereof shall in no way affect the validity or enforceability of any other provisions.



Lorraine Christine Hoffman, Esq.
Assistant Staff Counsel
The Florida Bar
File No. 2003-51, 109(15C)

c. Terminology. All personal pronouns used in this Agreement, whether used in the masculine, feminine or neuter gender, shall include all other genders; the singular shall include the plural and vice versa. Titles of Sections are for convenience only, and neither limit nor amplify the provisions of the Agreement itself, and all references herein to Sections or subdivisions thereof shall refer to the corresponding Article, Section or subdivision thereof of this Agreement, unless specified referenced is made to such Sections or subdivisions of another document or instrument.

d. Governing Law. This Agreement shall be governed and construed in accordance with the laws of the State of Florida, without giving effect to any conflicts of law principles.

e. Entire Agreement. This Agreement contains the entire understanding between the parties, supersedes all other negotiations understandings and representations (if any) made by and among such parties, and may not be changed or modified except by an Agreement in writing signed by all the parties.

f. Submission to Jurisdiction. Each of the parties to this Agreement irrevocably and unconditionally (a) agrees that any suit, action or other legal proceeding arising out of or relating to this Agreement shall be brought in the circuit court located in Palm Beach County, Florida or the court of the United States, Southern District of Florida; (b) consents to the jurisdiction of each such court located in any such suit, action or proceeding; (c) waives any objection which it may have to the laying of venue of any such suit, action or proceeding in any of such courts; and (d) agrees that service of any court paper may be affected on such party by mail, as provided in this Agreement or in such other manner as may be provided under applicable laws or court rules in said state.

g. Notice. Any notice required or permitted to be delivered hereunder shall be deemed to be delivered when either hand delivered or deposited in the United States mail, postage prepaid, registered or certified mail, return receipt requested, addressed to the parties at the addresses first stated herein, or to such other address as either party hereto shall from time to time designate to the other party by notice in writing as provided herein.

h. Counterparts. This Agreement may be executed in any number of counterparts and each such counterpart shall for all purposes be deemed an original.

i. Attorneys' Fees. If any legal action or other proceeding is brought by the Company for the enforcement of this Agreement, or because of an alleged dispute, breach, default or misrepresentation by the Individual in connection with any provision of this Agreement, the Company if successful in such legal action or other proceeding, shall be entitled to recover reasonable attorneys' fees, sales and use taxes, court costs and all expenses even if not taxable as court costs (including, without limitation, all such fees, taxes, costs and expenses incident to arbitration, appellate, bankruptcy and post-judgment proceedings), incurred in that action or proceeding, in addition to any other relief to which the Company may be entitled.

j. Survival. The provisions of Sections 2 through 7 hereof shall survive any termination of this Agreement.

k. Injunctive Relief. Individual acknowledges and agrees that in the event Individual violates any term, covenant or provision of this Agreement, the Company will suffer irreparable harm for which the Company will have no adequate remedy at law. Individual agrees that the Company shall be entitled to injunctive relief for any breach or violation of this agreement, including but not limited to the issuance of an ex parte preliminary injunction as set forth in Section 5 b., above, in addition to and not in limitation



Lorraine Christine Hoffman, Esq.
Assistant Staff Counsel
The Florida Bar
File No. 2003-51, 109(15C)

of any and all other remedies available to the Company at law or in equity. No remedy herein conferred upon the Company is intended to be exclusive of any other remedy, and each and every such remedy shall be cumulative and shall be in addition to every other remedy given hereunder or now or hereafter existing at law or in equity or by statute or otherwise. No single or partial exercise by the Company of any right, power or remedy hereunder shall preclude any other or further exercise thereof.

l. No Offsets. The existence of any claim or cause of action of Individual against any Company Entity, whether predicated on this Agreement or otherwise, shall not constitute a defense to the enforcement of this Agreement.

m. Employment Status. If Individual is an employee of the Company, nothing in this Agreement shall be construed or deemed to establish a definite term of employment, and subject to the terms of any separate written employment agreement between the parties (an "Employment Agreement"), both the Company and Individual retain the right to terminate the employment relationship at any time and for any reason. Except as set forth in any Employment Agreement, the parties agree that the Individual, if an employee of the Company, is an "at will" employee.

n. Waiver of Jury Trial. THE COMPANY AND THE INDIVIDUAL MUTUALLY AND WILLINGLY WAIVE THE RIGHT OF A TRIAL BY JURY OF ANY AND ALL CLAIMS MADE BETWEEN THEM WHETHER NOW EXISTING OR ARISING IN THE FUTURE, INCLUDING WITHOUT LIMITATION ANY AND ALL CLAIMS, DEFENSES, COUNTERCLAIMS, CROSSCLAIMS AND THIRD PARTY CLAIMS ARISING FROM OR RELATED TO THE NEGOTIATION, EXECUTION, BREACH AND/OR PERFORMANCE OF THIS AGREEMENT.

o. Conflict with Other Agreements. To the extent that this Agreement conflicts with the provisions of Sections 6, 7, and 8 of the Executive Employment Agreement dated August 3, 1999 between iviewit.com LLC, a Delaware limited liability company and the Individual, the terms of this Agreement shall govern.



Lorraine Christine Hoffman, Esq.
 Assistant Staff Counsel
 The Florida Bar
 File No. 2003-51, 109(15C)

IN WITNESS WHEREOF, the parties hereto have duly executed this agreement, in lieu of any prior agreement, on the day and year first written above.

Signed, sealed and delivered in the presence of:

Witnesses:

iviewit Technologies, Inc.

Jennifer Kluge Print Name
Guy Tarenti Print Name

By: *Brian Utley*
 Its: *Brian Utley*

THE INDIVIDUAL ACKNOWLEDGES AND AGREES THAT INDIVIDUAL HAS READ AND UNDERSTANDS THE TERMS SET FORTH IN THIS AGREEMENT AND HAS BEEN GIVEN A REASONABLE OPPORTUNITY TO CONSULT WITH AN ATTORNEY PRIOR TO EXECUTION OF THIS AGREEMENT.

Witnesses:

"Individual"

Jennifer Kluge Print Name
Guy Tarenti Print Name

Brian Utley Print Name



Lorraine Christine Hoffman, Esq.
 Assistant Staff Counsel
 The Florida Bar
 File No. 2003-51, 109(15C)

STATE OF FLORIDA)
) ss
 COUNTY OF PALM)
BEACH

Before me, the undersigned authority, appeared BRIAN UTLEY, who is personally known to me or who produced as identification a _____ showing him/her to be the person described in and who executed the foregoing instrument.

WITNESS my hand and official seal in the County and State last aforesaid this 23 day of February, 2000.



Martha Mantecón
 Commission # OC 821549
 Expires Mar. 28, 2003
 Beach, Fla
 Atlantic Bonding Co., Inc.

Martha Mantecón

 Notary Public
 State of FLORIDA at Large



Lorraine Christine Hoffman, Esq.
Assistant Staff Counsel
The Florida Bar
File No. 2003-51, 109(15C)

Exhibit C – Wachovia Business Plan

Confidential Private Placement Memorandum Number: V19

Offeree: _____

CONFIDENTIAL PRIVATE PLACEMENT MEMORANDUM



\$12 MILLION PREFERRED STOCK

December 2000

WACHOVIA SECURITIES, INC.

WACHOVIA

CONFIDENTIAL PRIVATE PLACEMENT MEMORANDUM

This confidential memorandum (the "Memorandum") is being furnished by iviewit Holdings, Inc. ("iviewit" or the "Company") to a limited number of institutional investors for the purpose of facilitating the sale of up to \$12 million of Preferred Equity (the "Securities") of the Company. Wachovia Securities, Inc. ("WSI") is acting as placement agent of the Securities.

In connection with your possible interest in purchasing Securities (the "Transaction"), WSI is delivering this Memorandum and you will be receiving certain non-public information concerning the Company. **By accepting a copy of this Memorandum, you agree that (i) you will hold in confidence and not disclose Evaluation Material (as defined below) (or the fact that such Evaluation Material has been made available to you and that discussions or negotiations are taking place concerning the transaction or any of the terms, conditions or other facts with respect thereto) except (a) to your Representatives who require such information for the purposes of evaluating the Transaction and who have been informed of the confidential nature of the information provided (it being understood that such Representatives shall be directed by you to treat such information in accordance with the terms of this Agreement), (b) you may make any disclosure of such information to which the Company gives its prior written consent and (c) in the event that you are required by law or regulation or requested by any governmental agency or other regulatory authority (including any self-regulatory organization having or claiming to have jurisdiction) or in connection with any legal proceedings and (ii) you will notify us as soon as practical in the event of any such disclosure (other than as a result of an examination by any regulatory agency), unless such notification shall be prohibited by applicable law or legal process.** "Evaluation Material" means information about the Company or the Transaction furnished by WSI, the Company or the Company's Representatives to you, together with all analyses, compilations, forecasts, studies and other documents prepared by you incorporating or otherwise reflecting such information but does not include information which (a) was publicly known at the time of disclosure, (b) subsequently becomes publicly known through no act or omission by you or your Representatives or (c) otherwise is known or becomes known to you other than through disclosure by WSI, the Company or the Company's Representatives from a source that is not bound by a confidentiality agreement or other legal or contractual obligation of confidentiality with respect to the information; and "Representatives" means employees, officers, directors, agents, attorneys, accountants and professional advisors and consultants. **You further agree that you will not use Evaluation Material for any reason or purpose other than to evaluate a possible Transaction. You agree that, if you do not enter into the Transaction, on request of the Company you will, as soon as practical, destroy or return to it (without retaining any copies thereof) all Evaluation Material (other than analyses, compilations, forecasts, studies and other documents prepared by you incorporating or otherwise reflecting such information).**

While the information in this Memorandum was obtained or compiled from data furnished by the Company and publicly available information and is believed to be accurate in all material respects, no representation, express or implied, or warranty as to the accuracy or completeness of the information contained in this Memorandum is made by any party, and nothing contained herein is or shall be relied upon as a promise or representation as to the future.

The Securities are being offered as a private placement pursuant to an exemption from registration contained in Section 4(2) of the Securities Act of 1933, as amended, and the rules and regulations promulgated thereunder. All investors will be required to undertake that they will not resell the Securities except pursuant to an effective registration statement or an exemption from registration. The Securities may bear a legend to that effect. Any such sale must also comply with any applicable state securities requirements. Investors should be aware that they will be required to bear the financial risks of this investment for an indefinite period of time.

The Securities have not been registered with, or recommended or approved by, the Securities and Exchange Commission or any other federal or state securities commission or regulatory authority, nor has the commission or any other federal or state securities commission or regulatory agency passed upon or endorsed the merits of this offering or the accuracy or adequacy of this Memorandum. Any representation to the contrary is a criminal offense. This Memorandum does not constitute an offer to sell or a solicitation of an offer to buy in any state or other jurisdiction in which such offer or solicitation would be unlawful, or in which the person making such offer or solicitation is not qualified to do so, or to a person to whom it is unlawful to make such an offer or solicitation. The distribution of this Memorandum and the offer and sale of the Securities may be restricted by law in certain jurisdictions. Persons into whose possession this Memorandum or any of the Securities comes must inform themselves about, and observe, any such restrictions.

Statements in this Memorandum are made as of the date hereof unless stated otherwise and are subject to change, completion or amendment without notice. Neither the delivery of this Memorandum at any time, nor any sale hereunder, shall under any circumstances create an implication that no change in the information contained herein or in the affairs of the Company has occurred subsequent to the date hereof.

Prospective investors should not construe the contents of this Memorandum as legal, tax or investment advice. Neither the Company nor WSI is making any representation to any prospective investor regarding the legality of an investment in the Securities by such prospective investor. Each investor should consult its own counsel, accountant or business advisor as to legal, tax, business, financial and related matters concerning its investment.

In making an investment decision regarding the Securities offered hereby, prospective investors must rely on their own examination of the Company, including, without limitation, any registration statements, reports or other documents which are available to the public, and the terms of the offering, including, without limitation, the merits and risks involved. Representatives of the Company and WSI will be available to discuss with prospective investors, on request, the information contained herein.

This Memorandum may contain summaries, believed to be accurate, of certain terms of certain documents, but reference is made to the actual documents, copies of which will be made available upon request, for the complete information contained therein. All such summaries are qualified in their entirety by this reference.

The Company reserves the right to withdraw this offering of the Securities at any time, to reject any commitment to subscribe for the Securities in whole or in part and to allot to any prospective investors less than the full amount of the Securities subscribed for by such investor.

FORWARD-LOOKING INFORMATION

Certain information contained in this Memorandum that is not historical fact, including but not limited to pro forma financial statements and the notes thereto, and financial projections are "forward-looking statements" (as such term is defined in the Securities Act and the Securities Exchange Act of 1934, as amended (the "Exchange Act")). In addition, from time to time, the Company or its representatives have made, or may make forward-looking statements, orally or in writing.

The Company cautions the reader that forward-looking statements involve prediction and no assurance can be given that results indicated in any forward-looking statements will be achieved. Various economic, competitive and other factors could cause actual results to differ materially from the Company's expectations.



WACHOVIA SECURITIES, INC.

IJL Financial Center
201 North Tryon Street
Charlotte, NC 28202
Fax: (704) 379-9025

Resurgens Plaza
945 East Paces Ferry Road, Suite 1200
946 Atlanta, GA 30326-1125
Fax: (404) 240-5121

John D. Deering
Senior Vice President
Phone: (704) 379-7812
john.deering@wachoviasecurities.com

Joe S. Lee
Associate
Phone: (404) 240-5023
joe.lee@wachoviasecurities.com

TABLE OF CONTENTS	PAGE #
I. EXECUTIVE SUMMARY	
1. TRANSACTION OVERVIEW	3
2. TECHNOLOGY OVERVIEW	4
3. BUSINESS STRATEGY	4
4. CUSTOMERS	6
5. MANAGEMENT TEAM	7
6. STRATEGIC ALLIANCES	7
7. FINANCIAL HIGHLIGHTS	8
8. USE OF PROCEEDS	10
II. INVESTMENT HIGHLIGHTS	11
III. INDICATIVE TERMS AND CONDITIONS	13
IV. COMPANY DESCRIPTION	
1. COMPANY OVERVIEW	14
2. TECHNOLOGY AND IP POSITION	14
3. ACHIEVED MILESTONES	17
4. CUSTOMERS	18
5. BUSINESS STRATEGY	19
6. STRATEGIC ALLIANCES	23
7. FINANCING HISTORY	26
V. MANAGEMENT	
1. ORGANIZATION CHART	27
2. SENIOR MANAGEMENT BIOGRAPHIES	27
3. BOARD OF DIRECTORS	28
4. ADVISORS	30
5. LEGAL & ACCOUNTING COUNSEL	30
6. OWNERSHIP STRUCTURE	32
VI. INDUSTRY OVERVIEW	
1. INDUSTRY INTRODUCTION	33
2. VIDEO STREAMING OVERVIEW	33
3. IMAGING OVERVIEW	35
4. COMPETITION	35
VII. FINANCIAL PROJECTIONS	39

EXHIBITS

A. DETAILED FINANCIAL MODEL

LIST OF FIGURES

<u>FIGURE</u>	<u>TITLE</u>	<u>PAGE #</u>
1	Projected Revenues	8
2	Projected Total Revenue Breakdown	9
3	Projected Income Statement	9
4	Use of Proceeds	10
5	Video Comparison Chart	16
6	Patent Milestones	16
7	Company Achieved Milestones	17
8	iviewit Customer List	18
9	Financing History	26
10	Organizational Chart	27
11	Ownership Structure	32
12	Projected Revenues	39
13	Projected Revenue Breakdown	40
14	Projected Video Revenue Breakdown	40
15	Projected Imaging Revenue Breakdown	41
16	Projected Income Statement	41

I. EXECUTIVE SUMMARY

Transaction Overview

Wachovia Securities, Inc. ("WSI") has been engaged by iviewit Holdings, Inc. ("iviewit" or the "Company") as its exclusive agent to assist the Company in raising up to \$12 million in preferred equity capital to become a leading end-to-end solutions provider of video and imaging products for delivery over the Internet. The Company is a developer and provider of proprietary, leading-edge visual and audio enabling, processing technologies supporting rich media streaming and imaging over the Internet. The Company can process and encode (digitize and compress) virtually all types of audio and video media into a variety of Internet-enabled formats while also optimizing the content for distribution across a variety of bandwidths. Using its technology, iviewit can provide multimedia solutions for Internet and CD-based applications. Also, iviewit can store, host, and distribute media content at its data centers or through multiple hosting partners.

iviewit is the leadership company providing video streaming technologies that deliver a rich video experience with virtually distortion-free, full screen capability at normal, TV-equivalent frame rates of 29.97 fps (frames per second) and providing imaging technologies that deliver rich images over the Internet. Similarly, iviewit is the first and only company to provide virtual imaging that preserves and delivers full image quality and detail of the original image - without distortion - not only during compression (up to 100:1), but also through high resolution zooming and panning.

The Company's revenue model is based primarily on encoding, serving, and licensing revenues. The Company commercialized its products in May 2000. Within a short period of time, iviewit has secured 17 customers - primarily in the entertainment, advertising, and hotel markets and many are high profile industry customers. The Company expects to realize approximately \$400,000 in revenue by year-end from these customers.

The Company has developed and launched the following three breakthrough video/audio streaming and image enhancement technologies that enable:

1. **full-screen, full-frame rate video** (including CD quality audio) at 150-300 Kbps, and at lesser bandwidths, a markedly improved video quality over current industry standards, as depicted below:

<u>Bandwidth Range</u>	<u>iviewit Frame Rate</u>	<u>Industry Typical Frame Rate</u>
28-56 Kbps	8-15 frames/sec.	4-8 frames/sec.
56-150 Kbps	15-30 fps	12-20 fps
150-300 Kbps	30 fps	12-24 fps

2. **full-screen, high definition pictures** that have "scan, pan and zoom, and virtual tour" capabilities at all bandwidths
3. **high fidelity, audio streams** at bandwidths as low as 56 Kbps and mono streams at bandwidths as low as 28.8 Kbps.

iviewit, located in Boca Raton, Florida, was formed in 1999 under the laws of the state of Delaware. Over the past year, iviewit has confirmed the efficacy and reliability of its technologies, initiated digital imaging production, established a demonstration website, developed an initial key management infrastructure, and hired an initial sales and production staff.

The Company continues to pursue an aggressive intellectual property strategy. iviewit has protected its enabling technologies by filing 6 patent pending applications in both the United States and abroad for its video streaming and imaging capabilities, covering a wide array of enabling technologies. The Company also has two remaining provisional patent pending applications that will be converted to patent pending status within the allowable period. The

Company has retained Foley & Lardner to shepherd its patent development and procurement. In addition, the Company has retained Kenneth Rubenstein of Proskauer Rose, LLP to oversee its entire patent portfolio – Mr. Rubenstein is the head of the MPEG-2 patent pool.

iviewit has assembled a complementary and seasoned, management team with executive rank, Fortune 100 and early-stage, entrepreneurial experience. The Company has retained Korn / Ferry to assist in the identification and recruitment of a high impact Chief Executive Officer (preferably from the media or entertainment industry) and an experienced Chief Technical Officer.

Since its June 1999 inception, the Company has raised over \$4.3 million of venture capital from Crossbow Ventures, Huizenga Holdings, and individual investors.

Technology Overview

iviewit's suite of video and imaging technology processes work across all industry platforms.

Imaging:

iviewit's imaging process is an enabling technology that creates an unparalleled, content-rich, viewing experience. Significant advantages of iviewit's imaging process include the following:

- Photo-quality Internet images
- Resistance to pixelation even at 30+:1 magnification (note: depending upon the material and the desired magnification)
- Full-screen and panoramic viewing up to 360°
- Consistent quality regardless of the end-user's Internet connection
- File sizes of 30Kb to 700 Kb for full panorama

Video:

The Company's video technologies allow high quality video streaming in the 150-300 Kbps range, providing better product and price performance for the product delivered and a significantly improved results in the 28-150 Kbps range. Below is a chart comparing iviewit's video capability to current industry levels:

<u>Bandwidth Range</u>	<u>iviewit Frame Rate</u>	<u>Industry Typical Frame Rate</u>
28-56 Kbps	8-15 frames/sec.	4-8 frames/sec.
56-150 Kbps	15-30 fps	12-20 fps
150-300 Kbps	30 fps	12-24 fps

The iviewit video technology is a highly scalable process costing approximately \$1.50/min of encoded video. The resulting files are ~25% less than comparable quality files. iviewit's 220Kbps streams are equivalent to competition 300Kbps streams.

Business Strategy

iviewit intends to serve as an end-to-end applications solutions provider incorporating iviewit's proprietary imaging and or video technologies as well as a full-service image and video encoding, hosting and serving provider. iviewit licenses its imaging solutions to B2B and B2C clients in the auction, collectibles, and retail space with subsequent marketing into the healthcare and medical markets. iviewit is also structuring OEM and re-seller relationships to bundle the imaging software and processes with existing hardware including: digital cameras, scanners, and PCs. iviewit is structuring video license agreements with major content and broadband access providers to incorporate the iviewit process into video encoding solutions for direct internet streaming.

iviewit technologies are "process technologies" with pending patents based on efficiency equations, and many of the applications for these technologies are just now being recognized.

Significant effort by iviewit in the development of research to improve and expand its processes and new uses for the efficiency equation are being now extensively explored in collaboration with others. The Company expects the industry to move toward improvements in pre-encoding, toward the development of internal efficiencies for encoding and codec formats, and toward new advances in broadband delivery in the future. iviewit expects to focus upon collaborative strategic relationships in research and marketing channels to continue to position and protect its intellectual properties.

As the industry discovers new applications, as “hot technology segments” appear and as competitors emerge in each space, iviewit expects to emphasize its role as an innovator and deliverer of solutions to the marketplace with focus upon improving the performance and cost characteristics of its business environment. For small entities that develop competitive technologies that become a “hot spot”, iviewit may either acquire the technology or possibly acquire the competition. For larger companies that provide a new competitive technology or “hot spot” in iviewit’s product and marketing space, collaborations, strategic alliances and licensing are traditional tools.

The Company’s current revenue model includes the following features:

- service and licensing products,
- charge per minute of processing of video – volume driven,
- charge hosting and serving and archiving on a GB basis, and
- turnkey suite for digital imaging.

iviewit plans to leverage its imaging and video technologies into three primary markets: Entertainment, E-commerce, Distance Learning/E-Learning. For intellectual property owners, including film studios, record companies, independent film producers, television networks, sports leagues, etc., iviewit’s technologies mean that video streaming can finally become a revenue source. Most of these firms have already begun to stream promotional clips over the Internet. Few, if any, have monetized their content.

The Company has a three-pronged strategy for penetrating its initial target market segments. The first is to target high-profile content owners and distributors as clients to process video, and images, market iviewit’s proprietary distance learning solutions and to brand those images and video with iviewit’s logo. The second is to partner with industry leaders to co-market iviewit’s service and license offerings. Third is to brand with famous celebrities and, entertainers, and leading destination sites interested in bringing marquee events to the Internet. Initial target market segments include the following:

- | | |
|---------------------------------|--------------------------|
| - Advertising | - Luxury Items |
| - Distance Learning/E-Learning | - Auction & Collectibles |
| - Entertainment: Film and Music | - Sports |
| - Health Care | - Modeling |
| - Hotel and Resorts | |

The Company expects to expand quickly to a total of 6 Regional Sales Managers post-funding. Revenue quota per Regional Sales Managers will be \$500,000 minimum annually. The Company plans to establish regional sales offices beginning with Los Angeles, New York, and Chicago. The Los Angeles office is underway, and it will operate as a sales and encoding facility.

Customers

Within a short period of time, the Company has been very successful in obtaining customers in its target market segments. Since launching the product in May 2000, the Company has experienced a 75% success rate in obtaining service and licensing customers, securing 17 customers to date. The Company expects to realize approximately \$400,000 in revenue by year-end from these 17 customers. Current clients include the following:

Hollywood.com	Dovebid/DSI
Hyatt Hotels & Resorts	Broadway.com
Gear Magazine (Guccione Media)	Z.com (Alanis Morissette)
Ellen DeGeneres	Virtual Education
Burst.com	Extreme Yachts

In addition, the Company has continued to develop an active pipeline of high impact, service and licensing client prospects. In fact, based on its current level of discussions, the Company believes that the following prospects have a high probability for closing by Q1 2001:

Warner Brothers	Eastman Kodak
Greg Manning Auctions / Collectibles	SDI-Media
UnoDosTres.com	Broadband Services
Brava	Wackenhut / Oasis

Currently, the Company is in negotiations with several large, video-content providers regarding licensing its video streaming technologies. iviewit is moving aggressively towards executing two or three landmark licensing agreements in order to facilitate the broader market adoption of its video streaming technology as the industry standard. As the Company continues these negotiations, it anticipates honing its pricing strategy for other comparable, large-content providers.

Recent developments include the following:

- iviewit has partnered with the “model program” (State of Iowa AEA model) for development of distance learning on a national basis. The Company is now collaborating with larger groups that represent applications for the federal government (i.e. Department of Defense, Department of Education) and with groups that represent similar programs in other countries such as Malaysia and South Korea.
- The Company is finalizing a major business alliance with one of the largest content providers in the entertainment industry, not just for Internet applications, but for many other uses as well. iviewit’s technology will not only be used for archival and on demand applications, but for “efficiencies in other disciplines” where cost and performance features are prominent measures. For example, in the delivery of content to broadcasting, pre-encoding preprocessing improvements will likely improve cost and quality.
- Recently, iviewit and Eastman Kodak began a series of discussions that are now formative, and an agreement could provide significant revenue as early as summer 2001. The applications for Kodak would follow a logical path to create a value added option that would initially be available on its “high end” digital cameras, and then be led downstream to the broad and sizeable moderately priced digital camera lines.

Management

Whereas the Company has retained Korn / Ferry to assist in the identification and recruitment of a high impact Chief Executive Officer (preferably from the media or entertainment industry) and Chief Technical Officer, iviewit has assembled a complementary and seasoned, management team with Fortune 100 and early-stage, entrepreneurial experience. This team consists of the following personnel:

Brian G. Utley, President (67) — For over 30 years, Mr. Utley was responsible for the development and world-wide management of many of IBM's most successful products such as the AS400 and the PC. His career with IBM culminated with his responsibility as Vice President and General Manager of IBM Boca Raton with a work force of over 6,000 professionals. He is a graduate of San Francisco City College.

Eliot I. Bernstein, Founder and Vice Chairman (37) — Prior to founding iviewit, Mr. Bernstein spent 15 years with SB Lexington where he was President of the West Coast Division creating and developing many innovative, computer-based multi-media marketing tools which remain in use supporting multi-billion dollar service industries. Mr. Bernstein is a graduate of the University of Wisconsin.

Michael A. Reale, Vice President of Operations (60) — Mr. Reale has over 20 years of operations experience, including P&L, quality, and delivery performance accountability. Most recently, Mr. Reale was the Chief Operating Officer for Boca Research (Nasdaq:BOCI), a manufacturer of personal computer enhancement and Internet thin client products. Mr. Reale received his BA and MBA from Pace University.

Raymond T. Hersh, Vice President of Finance (58) — Mr. Hersh has over 35 years of successful business and operating experience involving financial services, telecommunications, manufacturing, and corporate strategic planning. For over 20 years, Mr. Hersh has operated and grown companies in Florida, and most recently, he was co-founder and President/CEO of New Medical Concepts, Inc., a telecom company specializing in providing healthcare information. Earlier, he spent five years as an Enforcement Attorney with the U. S. Securities and Exchange Commission in New York City where he exited as a Branch Chief. He is a member of the New Jersey and New York Bars. Mr. Hersh received his BA from Lafayette College and his LLB/JD from the University of Pennsylvania.

Kevin J. Lockwood, Vice President of Sales and Business Development (40) — Mr. Lockwood joins iviewit from Cylex Systems where he held the position of Executive Vice President of Sales and assisted in securing three rounds of funding exceeding \$20 million. He also held the position of Head of Sales for Acer America, Inc. where he increased sales from a run rate of \$150 million annually to over \$1.5 billion annually in only a 17-month time. In addition, Mr. Lockwood successfully launched the Fujitsu P.C. into the U.S. and in the first year amassed revenues of over \$200 million. He is a graduate of the University of Maryland with a Bachelor of Science degree in Business Administration.

Guy Iantoni, Vice President of Sales (35) — Prior to joining iviewit in 1999, Mr. Iantoni was Senior Financial Representative with Fidelity Investments. From 1995 to 1997, he served as an Investment Management Consultant to the private client group of Morgan Stanley Dean Witter & Company, Inc. Mr. Iantoni has developed computer databases and systems to effectively market and target segments in both the financial markets and the healthcare industries. Mr. Iantoni is a graduate of the University of Wisconsin with an advanced degree in Pharmacy.

**Strategic
Alliances**

iviewit is creating a stable of strategic partners in the areas of technology, R&D, applications development, and video hosting and delivery. The Company has partnered with key industry leaders to develop precedence in the market. Partners include Greg Manning Auctions, Atlas Entertainment, Medical Online, Digital Island, Burst.com, and Versifi.

**Financial
Highlights**

The Company plans to initially focus on building a precedence through encoding services using its proprietary technology and through licensing its application to industry leaders. As customer acceptance and penetration continue to grow, serving and archiving revenues should begin to sharply rise. The Company expects video-related revenue to represent 60-70% of the total revenue.

iviewit anticipates reaching break-even in approximately 18 months. The revenue projections are as follows:

**Figure 1
Projected Revenues**

Video	Year 1	Year2	Year3
Encoding	\$564,435	\$5,305,221	\$14,202,070
Archival	\$98,465	\$1,189,155	\$4,851,618
Hosting	\$19,913	\$215,011	\$729,939
Serving	\$302,115	\$4,343,611	\$19,594,573
Master Licensing	\$675,000	\$3,431,250	\$3,993,750
Web Design & Consulting	\$113,100	\$480,600	\$458,400
Video Total by Year	\$1,659,929	\$14,484,248	\$43,371,950
Imaging			
Annual License Fee Revenue	\$21,000	\$150,500	\$323,500
Setup Fee Revenue	\$60,000	\$147,000	\$84,000
Hotel & Resort Packages Revenue	\$85,800	\$343,200	\$202,800
Image Processing Revenue	\$576,387	\$3,102,735	\$5,811,171
Master License Revenue	\$787,500	\$3,178,125	\$3,965,625
Hosting Revenue	\$22,775	\$180,002	\$516,868
Serving Revenue	\$232,529	\$2,290,568	\$7,860,524
Hosting & Serving Revenue for Hotels & Resorts	\$9,387	\$65,709	\$132,759
Archival	\$45,942	\$372,823	\$1,089,549
Web Design & Consulting	\$138,000	\$462,000	\$472,200
Imaging Total by Year	\$1,979,320	\$10,292,662	\$20,458,996
Grand Total by Year	\$3,639,248	\$24,776,909	\$63,830,946

Figure 2
Projected Total Revenue Breakdown

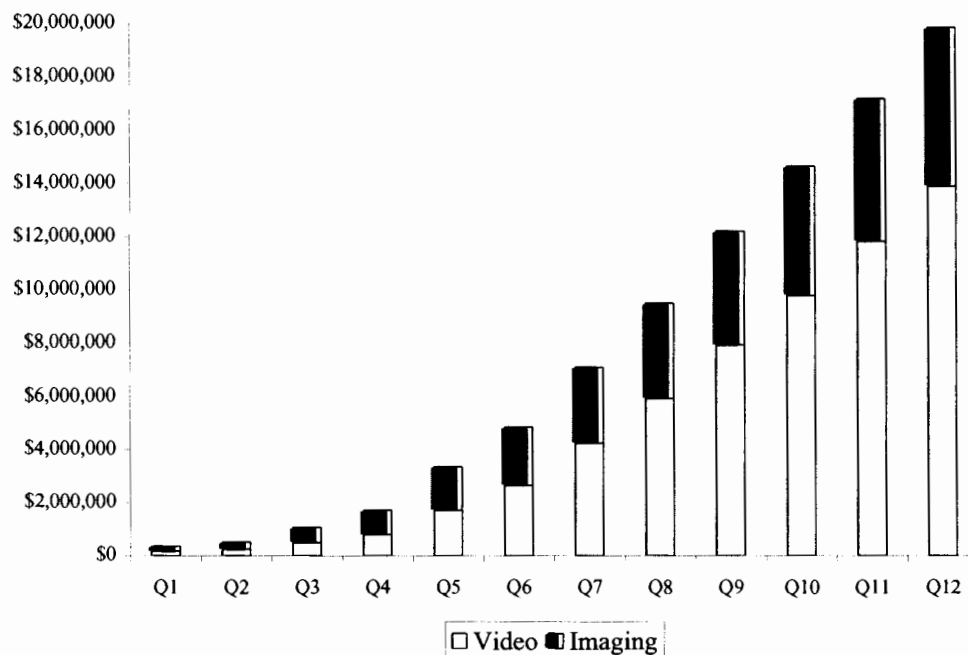

Figure 3
Projected Income Statement

	<u>YEAR 1</u>	<u>YEAR 2</u>	<u>YEAR 3</u>
REVENUE	\$ 3,639,248	\$ 24,776,909	\$ 63,830,946
COST OF GOODS SOLD	2,057,453	6,617,445	13,192,434
GROSS PROFIT	<u>1,581,796</u>	<u>18,159,464</u>	<u>50,638,512</u>
OPERATING EXPENSES:			
SELLING, GENERAL, & ADMINISTRATIVE	9,861,781	13,870,983	24,790,101
RESEARCH AND DEVELOPMENT	<u>776,326</u>	<u>1,705,086</u>	<u>2,686,204</u>
TOTAL OPERATING EXPENSES	<u>10,638,107</u>	<u>15,576,069</u>	<u>27,476,305</u>
OPERATING PROFIT (LOSS)	(9,056,311)	2,583,395	23,162,207
NET INCOME (LOSS)	<u>\$ (9,157,644)</u>	<u>\$ 2,364,062</u>	<u>\$ 16,378,757</u>
EARNINGS BEFORE INCOME TAXES, DEPRECIATION AND AMORTIZATION	<u>\$ (8,860,499)</u>	<u>\$ 3,871,945</u>	<u>\$ 26,610,280</u>

Use of Proceeds

To execute its strategy, the Company expects to use the proceeds of this offering as shown below:

**Figure 4
Use of Proceeds****Use of Proceeds**

Sales and Marketing	\$4,500,000
Expand Production Capabilities	\$2,400,000
Research and Development	\$1,300,000
General Corporate Purposes	\$2,600,000
Working Capital	<u>\$1,200,000</u>
	\$12,000,000

**Assumes a 16-18 month period*

II. INVESTMENT HIGHLIGHTS

◆ ***Unique processing technologies for video and imaging***

iviewit's patent pending processing technologies can create high-definition images with "scan, pan, and zoom" capabilities, high-fidelity audio streams, and full-screen, full-frame rate video for streaming over the Internet. The iviewit video technology is a highly scalable process. The resulting files are approximately 25% less than comparable quality files. iviewit 220Kbps streams are equivalent to competitive 300Kbps streams. The Company's imaging process delivers images that are photo-quality, resistant to pixelation even at magnification levels of 30+:1. Images produced by iviewit's proprietary process are identical in quality regardless of the end-user's Internet connection speed. File size options are tailored to minimize download times and optimize the end-user's experience.

◆ ***Complementary and Seasoned Fortune 100 and Entrepreneurial Management Team***

iviewit has assembled a complementary and seasoned management team with Fortune 100 and early-stage, entrepreneurial experience. Management consists of former IBM operations executives who have experience in building video delivery capabilities and of marketing talent from successful venture-backed technology companies. The Company recognizes its strength in operations and product development and recognizes the need to attract a capable, experienced CEO and CTO to accelerate the Company's development. iviewit has retained Korn / Ferry to assist in the identification and recruitment of this talent.

◆ ***Strong and Experienced Board of Directors and Advisory Board***

iviewit's Board of Directors and Advisors consist of several well-established individuals from the technology, entertainment, and financial community. Directors have extensive backgrounds with top-tier firms such as Goldman Sachs, Kidder Peabody, and McKinsey & Co. Crossbow Ventures has provided \$3.0 million in funding and sits on the Board. Technology and entertainment guidance comes from a partner at Armstrong Hirsch Jackoway & Wertheimer and from Kenneth Rubenstein, the head of the MPEG-2 patent pool.

◆ ***Significant Intellectual Property Position and Strategy***

iviewit has protected its enabling technologies by filing 6 patent pending applications in both the United States and abroad for its video streaming and imaging capabilities, covering a wide array of enabling technologies. The Company also has two remaining provisional patent pending applications that will be converted to patent pending status within the allowable period. The Company has retained Foley & Lardner to shepherd its patent development and procurement. In addition, the Company has retained Kenneth Rubenstein of Proskauer Rose, LLP to oversee its entire patent portfolio. The Company's strategy is to establish market precedence through licensing of trade secrets and know-how.

◆ ***Substantial Market Penetration and Growing Customer Acceptance***

The Company commercialized its products in May 2000. In just 5 months, iviewit has experienced a 75% success rate in obtaining service and licensing customers, securing 17 customers to date – primarily in the entertainment, advertising, and hotel markets. The Company expects to realize approximately \$400,000 in revenues by year-end from these customers. High profile customers include Ellen DeGeneres, Z.com (Alanis Morissette), Hyatt Hotels, Gear Magazine, and Hollywood.com. Highly probable for closing by year-end 2000 include Warner Brothers and Greg Manning Collectibles.

◆ ***Focused on Media Rich Target Markets – Unlocking the Value of Content***

The Company's business strategy is to first target high-profile content owners and distributors as clients to process video and images and to brand those images with iviewit's logo. Secondly, iviewit plans to co-brand with famous celebrities and

entertainers interested in bringing marquee events to the Internet. These initial target markets represent an enormous collection of video and image assets that are ripe for monetization. For intellectual property owners, including film studios, record companies, independent film producers, television networks, sports leagues, etc., iviewit's technologies means that video streaming can finally become a revenue source. Most of these firms have already begun to stream promotional clips over the Internet. Few, if any, have monetized their content.

◆ ***Broadband Promotes Greater Multimedia Supply and Demand***

The transmission of data intensive content over the Internet has been limited due to both technological and bandwidth constraints. However, the increasing availability of improved delivery systems, such as digital cable modems, T1 lines, satellite delivery systems and DSL networks are enabling the use of more feature-rich multimedia content. Even at these higher bandwidth speeds video quality remained poor. iviewit developed processes allowed users at these speeds to receive TV quality video streaming.

◆ ***Opportunities to Capture the True Value of E-Commerce***

The parties involved in video streaming include end consumers, business e-commerce sites, intellectual property owners and the digital distribution companies. iviewit's suite of technologies should positively affect and benefit all of these parties. For B2B e-commerce sites, iviewit's technologies should provide an affordable solution to enhance the promotion of their products and services. By digitizing already produced video commercials, infomercials, product announcements and product manuals through iviewit's proprietary system, business e-commerce sites can leverage their video and image investments into an on-demand Internet medium. There are over 14 million businesses with broadband connectivity indicating a large installed base of customers for quality visual experiences.

◆ ***Platform for Pay-Per-View via the Internet***

IP based distribution over TV networks is expected to become widespread over the next few years, driven by set top boxes, wireless distribution and TV integrated interfaces. Using a TV this way further enhances the quality of the video since a TV set is optimized for displaying video images. This paves the way for a new era in On Demand Pay-Per-View distribution due to the increased bandwidth efficiencies of IP based distribution.

Extensions of the current technologies are planned to provide similar improvements in IP based videoconferencing. Early testing has validated the feasibility of these extensions and funding will provide the resource necessary to complete the development work. It is estimated that products could be ready to market within 6-9 months from funding.

III. INDICATIVE TERMS AND CONDITIONS

\$12 Million Preferred Stock

- Issuer:** iviewit Holdings, Inc. (the "Company").
- Securities:** Convertible Preferred Stock of the Company (the "Preferred Stock"), which, on an as-if-converted to common stock basis, represents ___ % of the fully-diluted ownership of the Company.
- Amount of Financing:** Up to \$12 million
- Placement Agent:** Wachovia Securities, Inc. ("WSI").
- Investor(s):** Institutional "accredited investors" within the meaning of Rule 501 of Regulation D and "qualified institutional buyers" within the meaning of Rule 144A as promulgated under the Securities Act of 1933, to be arranged by WSI.
- Use of Proceeds:** Growth capital and general corporate purposes.
- Closing Date:** The date of completion of legal documentation and funding, which shall occur as soon as is practicable.
- Accrued Dividends:** ___ % per annum. The dividends will be cumulative and will be payable semi-annually payable-in-kind.
- Conversion:** Each share of the Preferred Stock shall be convertible at any time, at the option of the holder. If a majority of the holders elect to convert into Common Stock, then the Company will have the right to convert all the shares into Common Stock.
- Liquidation Preference:** In the event of any liquidation, sale, merger, consolidation or winding up of the Company, the Preferred Stock holders shall be entitled to receive, in preference to the holders of the Common Stock, a per share amount equal to the Purchase Price plus declared but unpaid dividends on such shares (the "Liquidation Preference"). After the payment of the Liquidation Preference to the holders of the Preferred Stock, the remaining assets shall be distributed ratably to the holders of the Preferred and Common Stock on an as-if-converted basis.
- Voting Rights:** The holders of the Preferred Stock shall be entitled to vote, on an "as converted" basis, on all matters to be voted on by stockholders of the Company.
- Mandatory Conversion:** After the third anniversary of issuance, if the Company has successfully completed a qualified IPO, the Company will have the right to force conversion of the Preferred Stock if the closing price for the Common Stock averages at least 200% of the Conversion Price for 90 consecutive days.
- Liquidity Rights:** On the later of 7 years after issuance of the Preferred Stock (the "Liquidity Exercise Date"), at the election of a majority of the holders of Preferred Stock, the Company will be required to redeem for cash all of the Preferred Stock. If there has been no IPO, the redemption price shall be the higher of the fair market value on an as converted basis or the Liquidation Preference. If there has been a qualified IPO, the redemption price shall be the Liquidation

Preference. No later than 30 days after the Liquidity Exercise Date, the Company will notify all holders of Preferred Stock that they may elect to redeem shares and shall provide such holders 60 days after such notice to make their election.

Registration Rights:

The holders of the Preferred Stock shall have the right to demand one long-form registration and unlimited piggyback registration rights with respect to the Preferred Stock and the Common Stock issued or issuable upon conversion of the Preferred Stock.

Board of Directors:

The holders of the Preferred Stock shall have the right to designate ___ members to the Board of Directors.

Representation and Warranties:

Usual and customary for investments of this type and size.

Covenants:

Financial Information: The Company will provide to any holder of Preferred Stock: quarterly and annual consolidated financial statements.

Inspection Rights: The Company will permit any Preferred Stock holder and its representatives to visit and inspect any of the properties of the Company or any subsidiary, to examine and duplicate their books and records and to discuss their affairs and finances with their respective officers, managers and independent public accountants, all at reasonable times and with reasonable notice.

Other Affirmative Covenants: (i) Maintenance of corporate existence, licenses and permits; (ii) Maintenance of insurance; (iii) Payment of taxes, assessments, government charges and levies, trade accounts, claims for work, labor or materials; (iv) Maintenance of properties; (v) Continuation of nature of business; (vi) Compliance with laws, rules and regulations; and (vii) Arms-length transactions with affiliates.

IV. COMPANY DESCRIPTION

Company Overview

The Company is a developer and provider of proprietary, leading-edge visual and audio enabling technologies supporting rich media streaming and imaging over the Internet. The Company can process and encode (digitize and compress) virtually all types of audio and video media into a variety of Internet-enabled formats while also optimizing the content for distribution across a variety of bandwidths. Using its technology, iviewit can provide multimedia solutions for Internet and CD-based applications. iviewit can store, host, and distribute media content at their data centers or through multiple hosting partners.

The Company has developed and launched three breakthrough video/audio streaming and image enhancement technologies that enable:

1. **full-screen, full-frame rate video** (including CD quality audio) at 150-300 Kbps, and at lesser bandwidths, a markedly improved video quality over current industry standards, as depicted below:

<u>Bandwidth Range</u>	<u>iviewit Frame Rate</u>	<u>Industry Typical Frame Rate</u>
28-56 Kbps	8-15 frames/sec.	4-8 frames/sec.
56-150 Kbps	15-30 fps	12-20 fps
150-300 Kbps	30 fps	12-24 fps

2. **full-screen, high definition pictures** that have "scan, pan and zoom, and virtual tour" capabilities at all bandwidths
3. **high fidelity, audio streams** at bandwidths as low as 56 Kbps and mono streams at bandwidths as low as 28.8 Kbps.

iviewit, located in Boca Raton, Florida, was formed in 1999 under the laws of the state of Delaware. Over the past year, iviewit has confirmed the efficacy and reliability of its technologies, initiated digital imaging production, established a demonstration website, developed an initial key management infrastructure, and hired an initial sales and production staff. The Company commercialized its products in May 2000 and has secured several high profile customers that have confirmed the commercial value of iviewit's technologies.

Technology and IP Position

iviewit's suite of video and imaging technology processes work across all industry platforms.

Imaging:

iviewit's imaging process is an enabling technology that creates an unparalleled, content-rich, viewing experience. Significant advantages of the Company's imaging process include the following:

- Photo-quality Internet images
- Resistance to pixelation even at magnification levels up to 30+:1 magnification (note: depending upon the material and the desired magnification)
- Full-screen and panoramic viewing up to 360°
- Consistent quality regardless of the end-user's Internet connection
- File sizes of 30Kb to 700 Kb for full panorama

funding in order to expand the intellectual property base and develop additional revenue opportunities.

Technology Development:

iviewit's goal is to maintain a leadership role in visual technologies and continued research and development will be deployed to this end. iviewit's product output will stress user friendliness, superior picture quality and effective presentation for the experience by the end user. New markets will include hardware and software applications that will embrace these platform technologies.

Extensions of the current technologies are planned to provide similar improvements in IP based videoconferencing. Early testing has validated the feasibility of these extensions and funding will provide the resource necessary to complete the development work. It is estimated that products could be ready to market within 6-9 months from funding.

IP based distribution over TV networks is expected to become widespread over the next few years, driven by set top boxes, wireless distribution and TV integrated interfaces. Using a TV this way further enhances the quality of the video since a TV set is optimized for displaying video images. This paves the way for a new era in On Demand Pay-Per-View distribution due to the increased bandwidth efficiencies of IP based distribution.

R&D efforts will also be heavily influenced by iviewit's focus on providing end-to-end solutions for its customers in new and emerging applications. One such application is the field of On Demand Distance Learning.

***Achieved
Milestones***

Since its inception in March 1999, iviewit has successfully raised over \$4.3 million in seed capital, launched its products, and developed a compelling IP position. Below are the key milestones the Company has achieved.

**Figure 7
Company Achieved Milestones**

March 1999	<ul style="list-style-type: none"> ▪ Filed 1st provisional patent ▪ Confirmed feasibility of full-screen, full-frame rate video
May 1999	<ul style="list-style-type: none"> ▪ Real3D technology audit
June 1999	<ul style="list-style-type: none"> ▪ Incorporated iviewit and raised seed capital
August 1999	<ul style="list-style-type: none"> ▪ Hired President
September 1999	<ul style="list-style-type: none"> ▪ Launched website ▪ Raised \$500M from Huizenga Holdings
February 2000	<ul style="list-style-type: none"> ▪ Raised \$1MM from Crossbow/Alpine Ventures
March 2000	<ul style="list-style-type: none"> ▪ Filed 1st Non-Provisional international patent
May 2000	<ul style="list-style-type: none"> ▪ Secured 1st customer: Hollywood.com ▪ Hired VP of Operations
June 2000	<ul style="list-style-type: none"> ▪ Launched imaging and video products at ShowBiz in Los Angeles
July 2000	<ul style="list-style-type: none"> ▪ Raised \$800,000 from Crossbow/Alpine Ventures
September 2000	<ul style="list-style-type: none"> ▪ Entered distance learning market
October 2000	<ul style="list-style-type: none"> ▪ Hired VP of Finance
November 2000	<ul style="list-style-type: none"> ▪ Completed technical review with Warner Brothers
December 2000	<ul style="list-style-type: none"> ▪ Raised \$1.2MM from Crossbow/Alpine Ventures ▪ Establishing Los Angeles, CA sales & production office

Customers

Within a short period of time, the Company has been very successful in obtaining customers in its target market segments. Since launching the product in May 2000, the Company has experienced a 75% success rate in obtaining service and licensing customers, securing 17 customers to date. Current clients include the following:

Hollywood.com	Dovebid/DSI
Hyatt Hotels & Resorts	Broadway.com
Gear Magazine (Guccione Media)	Z.com (Alanis Morissette)
Ellen DeGeneres	Virtual Education
Burst.com	Extreme Yachts

In addition, the Company has continued to develop an active pipeline of high impact, service and licensing client prospects. In fact, based on its current level of discussions, the Company believes that the following prospects have a high probability for closing by Q1 2001:

Warner Brothers	Eastman Kodak
Greg Manning Collectibles	SDI-Media
UnoDosTres.com	Dovebid/DSI
Brava	Versifi
	Wackenhut/Oasis

Currently, the Company is in negotiations with several large, video-content providers regarding licensing its video streaming technologies and is moving aggressively towards executing two or three landmark licensing agreements in order to facilitate the broader market adoption of its video streaming technology as the industry standard. As the Company continues these negotiations, it anticipates honing its pricing strategy for other comparable, large-content providers.

Below is a list of the current customers:

Figure 8
iviewit Current Customer List

Clients	2000 TOTAL	Projected	
		2001 TOTAL	2002 TOTAL
Hyatt	\$13,000	\$110,000	\$160,000
Hollywood.com/Broadway.com	\$54,000	\$141,715	\$293,861
Gear Magazine	\$75,000	\$160,000	\$160,000
Kis-met(Great Expectations)	\$5,250	\$10,736	\$22,262
Lovemate	\$3,250	\$10,736	\$22,262
DemoReel.TV	\$6,000	\$35,520	\$88,379
Medical Online	\$0	\$50,000	\$35,000
Wackenhut	\$7,500	\$32,208	\$66,787
JM Lexus	\$4,100	\$12,883	\$26,715
Boca Developers	\$5,000	\$22,500	\$48,312
Boca Resort	\$2,000	\$4,000	\$10,000
Kidscamps	\$2,000	\$13,000	\$34,892
KoKo	\$2,000	\$4,000	\$8,000
Z.com	\$120,000	\$120,000	\$120,000
Broadband Services Group	\$90,000	\$600,000	\$1,200,000
Virtual Education	\$10,000	\$121,875	\$326,106
IMTS	\$5,000	\$10,000	\$10,000
	\$404,100	\$1,459,173	\$2,632,575

Additional opportunities have arisen within E-commerce, Education/ Distance learning; and Entertainment.

1. **Broadband Services:** Upwards of 300 distance learning courses targeted to the National Guard: Expected Revenue: \$25,000 to \$50,000 per course. (Total revenue opportunity \$1 Million to \$3 Million dollars through 2001. Three other DOD RFP's with monies totaling over \$700MM for distance learning. iviewit projects securing 1% to 2% of total dollars allocated for iviewit's services.
2. **Iowa:** Distance learning for AEA in Cedar Rapids, Iowa. \$50,000 allocated for digitizing up to 6000 video clips. Three other projects under review.
3. **Wackenhut/Oasis:** iviewit to be used for online sales training, HR and Benefits education applications. Huge cost savings to Wackenhut/Oasis leveraging sales training over the web. They also have over 1000 customers to resell the iviewit solution.
4. **Kodak:** Interested in bundling our software for their high-end digital camera to be shipped out mid next year. Projected volumes: up to 500,000 units. Revenue estimated \$500,000 + in 2001.
5. **Burst:** 500 plus hours of video content to be encoded. Revenue estimated at \$150,000 to \$250,000.
6. **Warner Brothers:** iviewit technology is to be used at multiple sites. Currently being negotiated.

**Business
Strategy**

iviewit will serve as both an end-to-end applications solutions provider incorporating iviewit's proprietary imaging and or video technologies as well as a full-service image and video encoding, hosting and serving provider. iviewit is licensing its imaging solutions to B2B and B2C clients in the auction, collectibles, and retail space with subsequent marketing into the healthcare and medical markets. iviewit is also structuring OEM and re-seller relationships to bundle the imaging software and processes with existing hardware including: digital cameras, scanners, and PCs. iviewit is structuring video license agreements with major content and broadband access providers to incorporate the iviewit process into video encoding solutions for direct internet streaming.

The encoding procedure itself and the evolution recently of many "encoding farms" is not a solution, but simply a function of immediate demand. Going forward, significant emphasis will likely be focused upon the steps that occur before encoding (i.e. pre-processing for both internet and broadcasting), the enhancement of existing MPEG 2 format, and variations of MPEG-4 to improve it. Because iviewit has "process technologies" with pending patents focused on efficiency equations, the many applications for this technology are just now being recognized. Improvements in all three areas cited above will likely become a core area for new technology in the future. Significant effort by iviewit in the development of research to improve and expand its processes and new uses for the efficiency equation are being now extensively explored in collaboration with others. The Company expects many further patents, improvements in existing pending patents, and a broad "protective shield" for many new and future applications will be a focus for the Company. The industry will likely move toward improvements pre-encoding, the development of internal efficiencies for encoding and codec formats, and new advances in broadband delivery in the future. iviewit expects to focus upon collaborative strategic relationships in research and marketing channels to continue to position and protect its intellectual properties.

As the industry discovers new applications, as "hot technology segments" appear and as competitors emerge in each space, iviewit expects to emphasize its role as an innovator and deliverer of solutions to the marketplace with focus upon improving the performance and cost characteristics of its business environment. For small entities that develop competitive technologies that become a "hot spot", iviewit may either acquire the technology or possibly acquire the competition. For larger companies that provide a new competitive technology or "hot spot" in iviewit's product and marketing space, collaborations, strategic alliances and licensing are traditional tools.

iviewit will continue to aggressively develop its technologies, applications and its patent pool and forge strategic R&D relationships to help ensure its position as a leading provider of visual solutions. Strategic investments and acquisitions are also anticipated.

The Company's revenue model includes the following features:

- offer service and licensing products,
- charge per minute of processing of video – volume driven,
- charge hosting and serving and archiving on a GB basis, and
- turnkey suite for digital imaging.

The Company has a three-pronged strategy for penetrating its initial target market segments. The first is to target high-profile content owners and distributors as clients to process video, and images, market iviewit's proprietary distance learning solutions and to brand those images those images and video with iviewit's logo. The second is to partner with industry leaders to co-market iviewit's service and license offerings. Third is to brand with famous celebrities and, entertainers, and leading destination sites interested in bringing marquee events to the Internet. Initial target market segments include the following:

- | | |
|---------------------------------|--------------------------|
| - Advertising | - Luxury Items |
| - Distance Learning/E-Learning | - Auction & Collectibles |
| - Entertainment: Film and Music | - Sports |
| - Health Care | - Modeling |
| - Hotel and Resorts | |

1. E-Learning/Distance Learning:

To validate iviewit's business model and the efficacy of its core technologies, the distance learning market was chosen as the first and major entry point to position the Company. Distance learning and e-learning are already receiving large governmental grants, funding and are significant budget entries for international, national and state/local educational programs. Next to healthcare, the projected spending for this area of education is expected to grow more than any other budgeting level. iviewit has partnered with the "model program" (State of Iowa AEA model) for development of distance learning on a national basis. The Company is now collaborating with larger groups that represent applications for the federal government (i.e. Department of Defense, Department of Education) and with groups that represent similar programs in other countries such as Malaysia and South Korea. This has now led to the following new revenue generating projects for iviewit over the next 3 to 18 months:

- **The state of Iowa** has chosen iviewit for the development of the "Iowa Model" for interactive distance learning in the Iowa school system, and this opportunity represents approximately 14,000 existing and potential video learning titles that are now currently being used via mail. iviewit is expecting to receive grants for the first model programs for distance learning for the Internet for use of up to 1 million students that are a part of the Iowa program. During the next month, approximately \$50,000 is expected from Iowa for use of iviewit's technology, which would be the "fulcrum" for future projects. The Company's imaging and streaming technology would be the protocol employed by Iowa in its school system for distance learning and vocational training. The state of Iowa expects a rollout to other AEA districts in 2001-02.
- **The U.S. Department of Defense** expects to decide within the next 30 days on the RFP for distance learning and vocational training (college level) with an anticipated funding by the DOD in late 2000 of \$700 million. iviewit's major partner in this program is Broadband Services Corp. Broadband Services Corp. considers the

Company's technology a "centerpiece" for its proposal, and has provided funding for iviewit to present its applications in an interactive mode. The initial funding to iviewit is \$100,000 in 2000 and with award of the RFP, up to \$3 million in revenue in 2001, with similar size through 2005.

- **Broadband Services Corp.** is also the current recipient through some of its other partners of a \$300 million contract recently awarded for a Pacific rim country, e-Learning project which could incorporate iviewit technologies for imaging and video streaming similar to that of the DOD. While funding for this project has already been initiated, no revenues have been forecast in the iviewit model for 2001, although they could be significant.
- **Major Fortune 500 company with over 100,000 employees.** The Company is negotiating a service and licensing contract with a major Fortune 500 company with 100,000 employees for the use of iviewit's technology for both distance learning and training. In addition, the potential client would become an iviewit reseller of the Company's application on an OEM basis with up to 400 other companies that are vendor/partner-based entities with the client. No revenue projections are included in the current iviewit business model, but it is anticipated that they would begin during the first half of 2001.

2. Collaborative Technologies (including Entertainment)

iviewit's strategy is based upon "filling an established market and value-added need" rather than creating a need in the marketplace. The Company is finalizing a major business alliance with one of the largest content providers in the entertainment industry, not just for Internet applications, but for many other uses as well. iviewit's technology will not only be used for archival and on demand applications, but for "efficiencies in other disciplines" where cost and performance features are prominent measures. For example, in the delivery of content to broadcasting, pre-encoding preprocessing improvements will likely dictate cost and quality.

iviewit's collaborations are primary drivers in the development of entertainment forms. The Company expects to collaborate with a leading entity in the fields of HDTV and DVD that will provide attractive user alternatives in the future. While the initial phases will focus upon the Internet and its uses of the streaming and imaging platforms, there should be new alliances formed with leaders in other technical aspects of product delivery and applications.

iviewit technology has been well recognized by Hollywood studios and content providers, and over the past 8 months, iviewit has been developing a significant relationship with Warner Brothers. The Company believes that the mutual efforts with Warner Brothers will result in a significantly meaningful commercial relationship beginning early 2001. As a result of this pending opportunity with Warner Brothers and other advanced discussions underway with other media and California-based content providers, the Company is presently establishing a Los Angeles sales and encoding facility to be operating by year end 2000.

Another example of iviewit's business strategy is in its recent alliance with Burst.com. The Company is integrating Burst technology with the iviewit platforms to provide both a superb and consistent delivery of streaming video, and product applications that differentiate iviewit and Burst as leaders in their respective "backbone" applications. Burst now offers streaming media users a consistent "last mile solution" and exclusively recommends the iviewit technology as the protocol for others to use. The Company has begun to recognize revenue this month from this collaboration.

3. Digital Cameras and Instrumentation

The broadness of iviewit's technologies and its applications outside an Internet based environment depict the scope of the pending patents and their uses in other markets. One such application is in the huge and growing market for digitization, instrumentation, and consumer products such as the digital camera market. Recently, iviewit and Eastman Kodak began a series of discussions that are now formative, and an agreement could provide significant revenue as early as summer 2001.

The applications for Kodak would follow a logical path to create a value added option that would initially be available on its "high end" digital cameras, and then be led downstream to the broad and sizeable moderately priced digital camera lines. In each case the following would be the applications provided to Eastman Kodak for its new and future camera entries:

- The first stage would be the provision of iviewit's imaging technology as a CD that would be included with each camera, so that the consumer when "loading" it on his computer would be able to pan, zoom and "crop" pictures taken from the Kodak digital camera itself. The full iviewit imaging technology would be used on any picture taken, modified and prepared by the user. Currently, the discussions with Kodak include (for high end only) possible inclusion for its Spring 2001 High-end Camera Line (up to 500,000 units). iviewit would prepare the master CD, Kodak would provide the production of same and follow on with the Kodak servicing of this new application for consumers. iviewit would be the "second line" of expertise servicing this application.
- The second stage would be for the development of a software/hardware format that would be fit onto the camera itself during production. iviewit and Kodak would collaborate for this technology application. Concurrently, iviewit and Kodak would broaden the usage to its moderate priced digital camera entries.
- Kodak has requested from iviewit a quote for the above application – first for the high-end market and a licensing opportunity of major significance is underway at this time. Further, other applications of similar nature (both for OEM and reseller purposes) are being developed for the scanner market and the PC market with major companies. In each case, applications driven strategies, value added marketing and cost/performance characteristics are the focus.

The Company has initiated a search for an advertising/new media agency and a public relations agency with demonstrated competence in B2B enabling technologies. The Company currently retains a leading publicist in the entertainment industry. The Company's marketing plan includes the following:

- a national print media campaign targeting corporate decision-makers for encoding images and video for commercial websites,
- a national B2B public relations campaign that targets the streaming media and digital still-imaging markets and that builds awareness and demand for the Company's imaging technologies,
- a trade show plan to promote its video and imaging technologies,
- a plan for the acquisition and exploitation of exclusive internet video events to highlight the Company's technologies and turbo charge its public relations efforts, and partnerships with selected customers for the development of leading edge applications.

The build-out of the sales and marketing team for 2001 is as follows:

- **Inside Sales:** Each of 3 individuals will be focused on generating leads for the Sales Directors in the areas of Entertainment, Education/Distance Learning and E-commerce. The inside sales position will require a minimum of 2 years of sales

experience, experience within the target vertical a plus, and a proven track record of past sales success. The position incentive package will include stock options, monthly cash bonuses based on lead generation goals, and commissions based upon team quota attainment.

- **Regional Sales Manager:** Each of 6 individuals (3 sales executives existing) will be focused on quarterly revenue generation and long term relationship building from the areas of Entertainment, Education/Distance Learning and E-commerce. The Regional Manager position will require a minimum of 5 years of sales experience, experience within the target vertical a plus, and a proven track record of past sales success. The position incentive package will include: stock options and commissions based upon regional quota attainment.

Sales Regions: Northern CA, Southern CA, Seattle, Chicago, Boca Raton, New Jersey, New York, Boston, Dallas, Atlanta and Washington DC

Marketing Director: This individual will be responsible for developing marketing programs targeted to the areas of Entertainment, Education / Distance Learning and E-commerce. This individual will: be responsible for differentiating iviewit's technologies and offerings versus competition, strategic direction for new product and application creation, coordination of trade shows, coordination of advertising priorities, development of collateral materials, development of lead sources for the inside sales team. This individual will be responsible for communicating the company's image and branding both online and offline, day to day successes with new or existing accounts and strategic partners, and coordinating investor relations. The Marketing Director should have 10+ years of marketing expertise with a minimum of 5 years marketing applications or end-to-end solutions within the technology or Internet space.

**Strategic
Alliances**

**Greg Manning
Auctions**

iviewit & Greg Manning Auctions are developing a turnkey virtual zoomable imaging solution for collectibles in the following markets: Philatelic, Numismatics, Sports Trading Cards and Memorabilia, Comic Art/Comic Books, Movie Poster, Hollywood and Rock 'N Roll Memorabilia. There is the potential for 250,000 to over 1,000,000 images to process, host and serve per year.

Greg Manning Auctions is a specialty auction house that deals in stamps, coins, sports collectibles, fine art, diamonds, movie posters, film and music memorabilia, manuscripts, and autographs. Philately (stamp collecting) accounts for almost 50% of sales. The company takes items on consignment or buys them directly from the owners, then sells them at auctions in New Jersey and New York, by mail, by telephone, and online. The firm also conducts online auctions in China and Europe with Spanish philately specialist Afinsa Bienes Tangibles, which owns about 12% of Greg Manning Auctions.

Atlas Entertainment

Atlas Entertainment brings iviewit high profile branding, video-on-demand, and pay-for-view internet broadcast opportunities with the likes of Alanis Morissette, Ellen DeGeneres, etc.

Medical Online

iviewit and Medical Online are developing a turnkey imaging solution for zoom and pan into MRI, CT, X-ray, mammography and related images.

Medical Online's mission is to give patients, physicians, and hospitals easy access to an extensive online database of clinical diagnostic data compiled from a number of the world's preeminent medical institutions. With the help of the Medical OnLine search engine, users have the luxury of matching current diagnostic images and graphs with similar or identical archival records, complete with clinical information on each case. Using this data, doctors form stronger conclusions regarding a patient's condition, while patients acquire the information they need to take control of their healthcare.

Exodus

iviewit has an exclusive encoding relationship with Burst.com customers, co-marketing alliance agreements with Exodus, and preferred pricing and re-sell agreement for Digital Island streaming media hosting.

Digital Island

Digital Island's five regional data centers in Asia, Europe, and the US are connected to ISPs in more than 20 countries through its ATM (asynchronous transfer mode) backbone. It maintains more than 1,200 online content distributors, including America Online, The Wall Street Journal, and CNBC.com.

Burst.com

The Company is integrating Burst technology with the iviewit platforms to provide both a superb and consistent delivery of streaming video, and product applications that significantly differentiate iviewit and Burst as leaders in their respective "backbone" applications.

The company (formerly Instant Video Technologies) makes Burstware, which enables faster-than-real-time transmission of video and audio over computer networks. Unlike real-time streaming software, which is prone to network congestion, Burstware transmits better video and audio signals by delivering them faster than they can be viewed or heard. Burst.com offers software for server-based distribution and for desktop playback. The company integrates its technology with media player software made by Apple and Microsoft. Burst.com sells its products directly and through systems integrators such as Clover Technologies.

Versifi

The two parties have a co-marketing, R&D, and production relationship as well as inclusion of iviewit's imaging processes and software with the Versifi content management software for resale within the IBM e-commerce tool suite.

Versifi Inc. specializes in building easy-to-use, enterprise Java applications to enable the creation, delivery and management of dynamic Web content. Versifi's Dynamic Information Delivery (D.I.D.) system provides the underlying architecture for deploying high-change, content-rich intranet, Web and e-commerce sites without the associated costs and rigidity of limiting scripting technologies.

Virage

iviewit and Virage will re-sell services and co-develop integration of the iviewit video processes with Virage's video indexing and cataloging capabilities.

The company makes and hosts software that enables users to deploy, search, index, and manipulate video content over the Internet. Media companies can use Virage's software to manage incoming video and make entire libraries available digitally to staff, thereby eliminating stores of videotapes. Other companies can access any sort of video for their employees in the same way. The software can be used to make video available on the Internet, although Virage also offers outsource video management services.

Cura Group

iviewit is providing end-to-end online video training, education, and distance learning to Cura's 150 employer base.

The Cura Group takes over the time-consuming, often aggravating employer responsibilities that they do best - payroll, employment taxes, benefits, workers' compensation, government compliance, personnel matters, hiring and outplacement services, safety and more.

SDI-Media

iviewit & SDI will co-market and re-sell. SDI will incorporate the streaming video creation technology with their subtitling offerings in 17 different countries.

SDI Media is the world's largest supplier of subtitling services for the television, theatrical, video, and DVD industries. The group also operates state-of-the-art dubbing and voice-over facilities and offers Internet site and interactive game content localization. With offices in 17 countries throughout the world, SDI Media has a presence in all major time zones and the capability to deliver in any language for any media. SDI Media counts amongst its extensive client list many of the world's leading media and entertainment companies.

Documentation Services, Int'l

iviewit & DSI have partnered to offer turnkey virtual product listings to the B2B and B2C auction and exchange market places. DSI has video and photo production services in every zip code in the US and Canada. This production combined with iviewit technologies on the imaging and video side should offer sellers cost-effective video or zoom imaging solutions to display their assets for sale.

Since 1989 DSI has saved valuable time and money for thousands of buyers, sellers, brokers, dealers, and individuals around the world providing VHS video and 35mm photo documentation delivered via next day air. They are the only service where a customer can order a video or 35mm photo documentation today and have it delivered to their desk via next day air e-mail. DSI currently covers every zip code in the U.S. and over 3,000 cities in Canada. DSI will likely continue to expand their coverage as well as new services in order to better serve clients.

Five Star Productions

The two parties have a co-marketing relationship for high-end video production and encoding relationship for Five Star's greater than 14,000 title video library.

Five Star Productions™ is South Florida's #1 independent television and radio production company. Their goal is to entertain, enlighten and educate. Five Star's presence on the Internet extends their commitment to being a truly integrated, full-service production facility. Their full range of services allows them to manage projects from concept through execution, upholding the highest of standards.

**Financing
History**

To date, the Company has raised over \$4.3 million. Investors include Huizenga Holdings and Crossbow/Alpine Ventures.

**Figure 9
Financing History**

<u>Date</u>	<u>Investor</u>	<u>Amount</u>
June 1999	Individual Investors	\$208,000
September 1999	Huizenga Holdings	\$500,000
December 1999	Individual Investors	\$87,000
February 2000	Crossbow/Alpine Ventures	\$1,000,000
	Individual Investors	\$185,000
March 2000	Individual Investors	\$250,000
June 2000	Individual Investors	\$80,000
July 2000	Crossbow/Alpine Ventures	\$800,000
December 2000	Crossbow/Alpine Ventures	\$1,200,000
	TOTAL	\$4,310,000

V. MANAGEMENT

Organization Chart

Figure 10
Organizational Chart

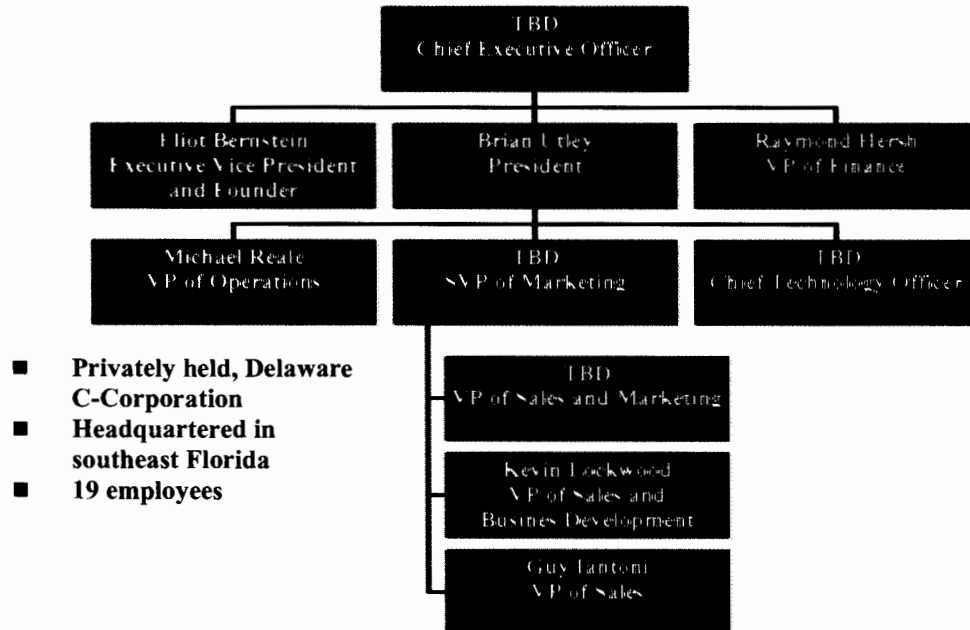

Senior Management Biographies

Whereas the Company has retained Korn / Ferry to assist in the identification and recruitment of a high impact Chief Executive Officer (preferably from the media or entertainment industry) and Chief Technical Officer, iviewit has assembled a complementary and seasoned, management team with Fortune 100 and early-stage, entrepreneurial experience. This team consists of the following personnel:

Brian G. Utley, President (67) — For over 30 years, Mr. Utley was responsible for the development and world-wide management of many of IBM's most successful products such as the AS400 and the PC. Entering IBM's executive ranks in the early 1980s, Mr. Utley's impact was felt in all areas of IBM's advanced technology product development, including Biomedical Systems, European Operations, and most importantly, IBM's launch of the Personal Computer. Following the introduction of the PC in the United States, Mr. Utley moved to Europe where he was responsible for a number of IBM's overseas activities including managing the launch of the PC across Europe and the Middle East. His career with IBM culminated with his responsibility as Vice President and General Manager of IBM Boca Raton with a work force of over 6,000 professionals. He is a graduate of San Francisco City College.

Eliot I. Bernstein, Founder and Vice Chairman (37) — Prior to founding iviewit, Mr. Bernstein spent 15 years with SB Lexington where he was President of the West Coast Division creating and developing many innovative, computer-based multi-media marketing tools which remain in use supporting multi-billion dollar service industries. Mr. Bernstein is a graduate of the University of Wisconsin.

Michael A. Reale, VP of Operations (60) — Mr. Reale has over 20 years of operations experience, including P&L, quality, and delivery performance accountability. Most recently, Mr. Reale was the Chief Operating Officer for Boca Research (Nasdaq:BOCI), a manufacturer of personal computer enhancement and Internet thin client products. Prior to Boca Research, Mr. Reale spent two years as President of MGTV Manufacturing Corp., a premier provider of computer memory assemblies with operations in the U. S. and Europe.

Mr. Reale was also responsible for seven operations in the United States and overseas as Senior Vice President for SCI Systems, Inc., a Fortune 500 electronics contract manufacturer. His operating background also includes twenty years with IBM culminating as Director of Manufacturing for the Personal Computer Division. Mr. Reale received his BA and MBA from Pace University.

Raymond T. Hersh, Vice President of Finance (58) — Mr. Hersh is a private investment banker, specializing in strategic development. He has over 35 years of successful business and operating experience involving financial services, telecommunications, manufacturing, and corporate strategic planning. For over 20 years, Mr. Hersh has operated and grown companies in Florida, and most recently, he was co-founder and President/CEO of New Medical Concepts, Inc., a telecom company specializing in providing healthcare information. He successively grew two Florida-based specialty manufacturing companies from combined revenues of about \$2.7 million to over \$19 million. Mr. Hersh also spent nine years as an investment banker in New York City where his last position was President of a member firm of the New York and American Stock Exchanges. Earlier, he spent five years as an Enforcement Attorney with the U. S. Securities and Exchange Commission in New York City where he exited as a Branch Chief. He is a member of the New Jersey and New York Bars. Mr. Hersh received his BA from Lafayette College and his LLB/JD from the University of Pennsylvania.

Kevin J. Lockwood, Vice President of Sales and Business Development (40) — Mr. Lockwood joins iviewit from Cylex Systems where he held the position of Executive Vice President of Sales and assisted in securing three rounds of funding exceeding \$20 million. He also was instrumental in developing a distribution channel as well as signing accounts such as Outsourcing International, Tampa General and a significant seven-year contract with Best Buy Corporation. He also held the position of Head of Sales for Acer America, Inc. where he increased sales from a run rate of \$150 million annually to over \$1.5 billion annually in only a 17-month time. In addition, Mr. Lockwood successfully launched the Fujitsu P.C. into the U.S. and in the first year amassed revenues of over \$200 million. He is a graduate of the University of Maryland with a Bachelor of Science degree in Business Administration.

Guy Iantoni, Vice President of Sales (35) — Prior to joining iviewit in 1999, Mr. Iantoni was Senior Financial Representative with Fidelity Investments. From 1995 to 1997, he served as an Investment Management Consultant to the private client group of Morgan Stanley Dean Witter & Company, Inc. Prior thereto, Mr. Iantoni spent four years with Eli Lilly and Company creating and implementing many direct marketing and sales campaigns for the healthcare industry. He has developed computer databases and systems to effectively market and target segments in both the financial markets and the healthcare industries. Mr. Iantoni is a graduate of the University of Wisconsin with an advanced degree in Pharmacy.

**Board of
Directors**

**Simon L. Bernstein – Chairman Emeritus
SB Lexington**

Mr. Bernstein has pioneered the development of proprietary life insurance products and has formed two companies to facilitate the sales of these products. Mr. Bernstein developed for both companies a national sales and marketing network, which now account for over a billion in life premium sales. Mr. Bernstein's career in the life insurance industry began in 1965 when he became the top producer for Aetna Life and Casualty Company. He has remained in the top 5% of life insurance sales agencies since that time. Mr. Bernstein supplied the initial "angel" investment for iviewit.

Eliot I. Bernstein – Founder & Vice Chairman

Brian G. Utley - President

Kenneth Anderson
myCFO

Mr. Anderson brings over 20 years of experience in the financial services world to his recent move to Jim Clark's new start-up myCFO. Prior to joining myCFO, Mr. Anderson served as a partner in Arthur Andersen's private client services practice where he created the family wealth and financial planning practice for the southern California practice. He focused on estate and income tax planning for high net worth individuals and families. Mr. Anderson has significant experience in compensation, insurance, and business succession consulting.

He is a board member of the Idyllwild Arts and Boy Scouts of America, Western Council. Ken is a founding member of the Family Business Program at the University of Southern California. He served as director of the Society of CPA/Financial Planners, was a member of the California CPA Society Committee on Personal Financial Planning. Mr. Anderson is on the Board of Directors of iviewit and Schaeffer Autosimulation, LLC. Mr. Anderson holds a BS in accounting and economics from Valparaiso University and a JD with an emphasis on taxation from the Valparaiso University School of Law.

Maurice R. Buchsbaum
Chief Executive Officer, Emerald Capital Partners

Mr. Buchsbaum has engaged in corporate finance projects as a principal, advisor, consultant, officer, director or senior managing director for the past 27 years. As a partner or senior officer of several leading investment banks (including Drexel Burnham, Kidder Peabody and JW Genesis), he has worked in all aspects of corporate finance. He formed Emerald Capital Partners in early 1999, to provide strategic planning and banking advice to a myriad of small and medium sized American growth companies. He has engaged in numerous public and private transactions and activities that include seed capital, early stage financing, major and late stage strategic finance, restructuring and mergers/acquisitions ranging in size from \$1 million to \$700 million. His industry experience includes health care, technology, telecommunications, biotechnology, financial services, environmental, and airlines. He holds BS and MBA degrees with honors from Ohio State University, and was a fellow in the doctoral program at Northwestern University.

Donald G. Kane, II
President, GDI

Prior to joining GDI (a privately held holding company that controls four B2B companies), Mr. Kane was a Managing Director in the Investment Banking Division of Goldman Sachs & Co. During his fourteen-year career at Goldman Sachs, Mr. Kane created the firm's Midwest Financial Institutions practice and founded the Global Financial Institutions Technology Group. He is a Board member and Vice Chairman of Sagence Systems, Inc., a GDI company and is a member of the Board of Versifi, Inc. and Ergo Systems. Mr. Kane is an advisor to Signcast, Inc., Gryphon Holdings, and Capita Technologies. He is a member of the Kellogg Graduate School of Management Advisory Board at Northwestern University and is a member of the Board of the Metropolitan YMCA of Chicago.

Gerald R. Lewin
Senior Partner, Goldstein Lewin & Co.

Mr. Lewin has been a certified public accountant since 1973 and is licensed to practice in the states of Florida and Michigan. Mr. Lewin is a Senior Partner of Goldstein Lewin & Co., a leading southeastern accounting firm. Mr. Lewin specializes in business consulting and is highly knowledgeable in many areas of accounting, tax and financial planning. Mr. Lewin is a member of both the American Institute of Certified Public Accountants and the Florida Institute of Certified Public Accountants.

H. Hickman Powell
General Partner, Crossbow Ventures

Prior to joining CrossBow Ventures, Mr. Powell spent 14 years as an investment analyst and corporate finance advisor. He worked with McKinsey & Company and J.P. Morgan

Investment Management, both based in London. Among his primary areas of expertise are technology research and economic research, including electronics, telecommunications and computer software. Most recently, he was Senior Technology Analyst and Vice President of Southeast Research Partners, Inc. where he worked with leading technology companies. He earned a bachelor of arts degree at Yale University and a master of business administration degree at Stanford University.

Advisors
Alan J. Epstein
Partner, Armstrong Hirsch Jackoway Tyerman & Wertheimer, P.C.

Mr. Epstein's law practice consists of advising Internet companies on various issues pertaining to the entertainment and sports industries, including the creation, licensing and acquisition of content, the introduction and negotiation of strategic partner relationships, and various other matters relating to the convergence of technology and content. Mr. Epstein also advises his firm's numerous celebrity clients on the exploitation and protection of their name and likeness rights and content on the Internet, as well as merchandising, endorsement and sponsorship deals. Prior to entering the UCLA School of Law, Mr. Epstein was a certified public accountant at Deloitte Haskins & Sells in Dallas, Texas.

Kenneth Rubenstein
Partner, Proskauer Rose LLP

Mr. Rubenstein is a partner at Proskauer Rose LLP law firm and is the patent attorney for iVieWit. He is a registered patent attorney before the U.S. Patent & Trademark Office. Mr. Rubenstein counsels his clients with respect to the validity and infringement of competitors' patents, as well as prosecutes patent applications. For the past several years he has worked on the formation of a patent pool, for MPEG-2 technology, involving large consumer electronics and entertainment companies. He is also a former member of the legal staff at Bell Laboratories. Mr. Rubenstein received his law degree, cum laude, from New York Law School, and his Ph.D. in physics from the Massachusetts Institute of Technology where he also graduated with a B.S. Degree.

Christopher C. Wheeler
Partner, Proskauer Rose LLP

Mr. Wheeler is a member of Proskauer Rose LLP's Corporate Department and as a partner in the Florida office has a versatile transactional practice. He has had extensive experience in real estate and corporate law, institutional lending and workouts, administrative law and industrial revenue bond financing. Moreover, he serves as a strategist and counselor to many clients in handling their other legal and business matters. Mr. Wheeler is well-versed in general corporate law as well as mergers and acquisitions and securities matters. He has guided companies from startup through initial private placements to public offerings. A graduate of Hamilton College and Cornell Law School, Mr. Wheeler was a member of the managing Board of Editor of the Cornell Law Review.

**Legal &
Accounting
Counsel**
Arthur Andersen, LLP

Arthur Andersen's vision is to be the partner for success in the New Economy. The firm helps clients find new ways to create, manage and measure value in the rapidly changing global economy. With world-class skills in assurance, tax, consulting and corporate finance, Arthur Andersen has more than 70,000 people in 83 countries that are united by a single worldwide operating structure that fosters inventiveness, knowledge sharing and a focus on client success. Since its beginning in 1913, Arthur Andersen has realized 86 years of uninterrupted growth, with 1999 revenues over \$7 billion. Arthur Andersen is a business unit of Andersen Worldwide.

Proskauer Rose, LLP

This law firm is one of the nation's largest law firms, providing a wide variety of legal services to major corporations and other clients through the United States and around the

world. Founded in 1875 in New York City, the firm employs 475 attorneys and has wide experience in all areas of practice important to businesses, including corporate finance, mergers and acquisitions, real estate transactions, bankruptcy and reorganizations, taxation, litigation and dispute resolution, intellectual property, and labor and employment law.

Armstrong Hirsch Jackoway Tyerman & Wertheimer, P.C.

One of the nation's leading entertainment law firms. Based in Los Angeles, California, it represents many of the most prominent actors, writers, directors and producers of feature films, television programming and other entertainment content. The firm also represents various content and technology companies in the Internet industry, including prominent web sites, entertainment-oriented portals, aggregated celebrity sites and various e-commerce companies. The firm is assisting in developing the business structure and strategic relationships for iviewit.

Foley & Lardner

One of the oldest and largest law firms in America. Founded in 1842, the firm now has more than 750 attorneys in 14 offices, following the February 1996 merger with Weissburg and Aronson, Inc. Foley & Lardner's over 100 highly skilled intellectual property attorneys constitute one of the largest and most sophisticated technology groups in a general-practice law firm in the United States. As one of the few large national law firms with a global intellectual property law group, it is uniquely positioned to help iviewit capitalize on its foreign filings. The firm's broad-based representations in litigation, regulatory affairs and general business counseling is complemented by one of the world's most highly trained staffs, which includes 65 engineering and advanced technical degrees, including 12 Ph.D.'s. The list of clients using Foley & Lardner to fill their intellectual property legal needs ranges from small entrepreneurial start-up companies to large international and multinational corporations. Foley & Lardner attorneys provide solutions and successfully serve the needs of clients around the world, including those situated in the United States, Canada, Latin America, the European Union, Eastern Europe, the Middle East, and the Pacific Rim.

- **William J. Dick** - Special Counsel to the West Palm Beach office of Foley & Lardner. A member of the firm's Intellectual Property Department (Electronics Practice Group), Mr. Dick currently focuses on mentoring other members of the Electronics and Consumer Products Practice Groups in various IP related matters. He also conducts weekly classes in patent related matters for new associates. Mr. Dick joined Foley & Lardner after 26 years with IBM. He began as a patent attorney, and has handled all phases of patent, trademark and copyright duties, including litigation. Mr. Dick's most recent position with IBM was as Assistant General Counsel to IBM Asia Pacific. Mr. Dick is a graduate of the University of Virginia (B.M.E., 1956; L.L.B., 1962 changed to J.D., 1970)
- **Douglas Boehm** - a partner in the Milwaukee office of Foley & Lardner and a member of the firm's Intellectual Property Department (Consumer & Industrial Products Practice Group and Health Information Technology Practice Group), Mr. Boehm practices in the areas of patent, trademark, copyright, and trade secret counseling; U.S. and foreign patent prosecution; and computer software and intellectual property licensing and technology transfers. Mr. Boehm's technical focus encompasses electrical and electronic engineering, including analog/digital/RF circuitry, radio telecommunications, lasers and fiber optics, and computer hardware and software. He has extensive experience in private industry, having worked as a development engineer and patent agent for Motorola, and as patent counsel for a subsidiary of Amoco Technology Company.

Ownership**Figure 11
Ownership Structure**

Shareholder	Number of Diluted Shares	Ownership	Voting
Preferred Series A			
Crossbow/Alpine Ventures	2,580	2.4%	8.3%
Common Series A			
Eliot Bernstein	11,320	10.7%	36.3%
Crossbow/Alpine Ventures ⁽¹⁾	7,795	7.4%	25.0%
Simon Bernstein	5,350	5.0%	17.1%
Huizenga Holdings	3,007	2.8%	9.6%
Other	1,162	1.1%	3.7%
Total Voting	31,214	29.5%	100.0%
Common Series B			
Crossbow/Alpine Ventures	21,341	20.1%	
Eliot Bernstein	12,330	11.6%	
Simon Bernstein	5,000	4.7%	
Brian Utley	3,428	3.2%	
iviewit Technologies	5,000	4.7%	
Other Management	4,055	3.8%	
Other ⁽²⁾	23,591	22.3%	
Total Non-Voting	74,745	70.5%	
Total Shares Outstanding Diluted	105,959	100.0%	

(1) Includes anti-dilution rights

(2) Includes 2,995 non-issued employee options

VI. INDUSTRY OVERVIEW

Industry Introduction

Even in today's "narrowband" Internet environment, rich media is already becoming mainstream. Audio and video streaming and rich media downloads (e.g., MP3 files) are among the most popular Internet applications. For example, MP3 is still one of the most popular search terms on the Web. Furthermore, there are currently over 80 million installed Real Players, 40 million Microsoft Windows Media Players, and 20 million Apple Quick Time Players. According to Media Metrix, 20 million home users and 9 million work users used streaming media in 1999. Importantly, returning to the metrics of minutes, it is estimated that there were over 145,000 hours/week of live sports, music, news, and entertainment being broadcast over the Internet using Real Networks technology in 1999. These trends are leading indicators of building demand for rich Internet media and the infrastructure needs associated with fulfilling the demand.

One key macro trend that will likely accelerate the migration of rich media to the Internet is the convergence of offline and online media companies. The recent AOL/TimeWarner merger is the first wake up call that the convergence of offline and online media is both real and big. The AOL/Time Warner combination brings together the key elements that should drive rich Internet media, namely a broad Internet audience, offline media assets, and extensive broadband capabilities. This trend should continue with further broadband or all-band initiatives as well as partnerships and mergers between offline and online media companies.

Forrester Research projects that 35% of Internet users, or 62 million, will have broadband access by 2003, up from 6% in 1999. More immediately, IDC estimates that U.S. broadband subscribers will triple by the end of 2000, reaching 17.5 million, up from 6 million in 1999.

Video Streaming Overview

Until now, the delivery of content over the Internet was substantially text-based, and attempts to transmit video content over the Internet have been marred by long downloads, small image size, reduced frame rates and poor unacceptable quality. Reducing the bandwidth time it takes to transmit files usually has meant delivering a picture that appears "herky-jerky" and out of sync with the sound. Providing video that is comparable with television (full motion/full screen/full frame rates), on the other hand, typically has been impossible because of the large file sizes resulting in the need for over 2 T1 lines of bandwidth to watch a single video. Trying to squeeze television-quality video files into sizes that can be transmitted on the Internet proved elusive accompanied by severe limitations, such as the requirement for costly and often unavailable bandwidth.

Current industry processing techniques do not provide solutions for clear, full TV frame rate, full screen streaming video at 150+ Kbps. Current videos tend to be herky-jerky and "kung-fu movie like" in that video and audio do not match even over broadband. Also, many current videos can typically only be viewed as 1/16 of the screen in order to improve the apparent quality of the picture. State of the art video even for high bandwidth users (ISDN, DSL, Cable, T1 and Fiber) remains "framey" and out of sync.

As recently as December 1999, *The Industry Standard* indicated that the Internet speed required for Television-like quality video would not be possible until the 700+ Kbps range was reached and that "nowhere in the tech world have there been more unfulfilled promises than in the realm of next-generation television." iviewit's video technologies have bridged the gap by enabling distortion-free, TV quality video frame rates with CD quality audio as low as 150+ Kbps range, considered optimal for delivering broadcasts over the Internet. iviewit's video technologies also greatly enhance the modem users' experience, providing a richer video than previously thought possible.

The transmission of data intensive content over the Internet has been limited due to both technological and bandwidth constraints. However, the increasing availability of improved delivery systems, such as digital cable modems, T-1 lines, satellite delivery systems and DSL networks are enabling the use of more feature-rich multimedia content. Even at these higher bandwidth speeds video quality remained poor until iviewit developed processes that allowed users at these speeds TV quality video streaming. These broadband systems typically allow sustained data transfer to the user of at least 256 kilobits per second, or more than 5 times the access speed of the fastest standard narrowband modems.

The broadband industry is drawing billions of dollars in capital investments to develop the necessary infrastructure for broadband content and delivery. The cable companies are massively marketing this existing user base to include broadband access. Similarly, the telephone companies are upgrading their lines to offer DSL access. In addition, major hardware manufacturing companies, application developers and content providers are racing to be the de facto standard for broadband delivery.

Multimedia streaming technology is bringing new levels of versatility, quality and simplicity to the creation and distribution of multimedia content over the Web. One measure of the growth in use of streaming media is the number of registered users posted by RealNetworks, a company that develops software used by broadcasters to stream multimedia content over the Internet. The first RealPlayer was released in 1995, and to date, over 80 million unique users have been registered. The RealPlayer download rate now exceeds 175,000 per day, an increase of more than 270% since the beginning of 1997.

Streaming media is now the most widely used application, after browsers and online programs like AOL, on the Internet, and it is growing exponentially. Microsoft's Media Player, RealNetworks player and Apple's Quick-Time player are, together, installed on over 100 million PC's worldwide. Clearly, consumers want quality video, of their own selection, at a time convenient to them, on demand.

The parties involved in video streaming include end consumers, business e-commerce sites, intellectual property owners and the digital distribution companies. iviewit's suite of technologies should positively affect and benefit all of these parties.

- For consumers who have a broadband "pipe" in their homes, streaming video is the "killer application." The promise of rich visual content defines the reason for paying \$40 - \$50 per month for the increased bandwidth. It means that consumers can see the entertainment, news, product commercials, infomercials and education videos they want - at near TV quality. This promise should be maximized by the proliferation of content delivered through and with iviewit. The companies responsible for providing the infrastructure for broadband recognize the importance of promoting enabling technologies and driving media-rich content to the web. The paradigm has shifted to include content creation as a significant element of their overall strategy. Greater availability of quality content on the web should increase demand for the pipes necessary to view it.
- For B2B e-commerce sites, iviewit's technologies should provide an affordable solution to enhance the promotion of their products and services. By digitizing their already produced video commercials, infomercials, product announcements and product manuals through iviewit's proprietary system, business e-commerce sites can leverage their video and image investments into an on-demand Internet medium. There are over 14 million businesses with broadband connectivity indicating a large installed base of customers for quality visual experiences. Licensing these B2B sites will be a primary market focus for iviewit's technologies.
- For intellectual property owners, including film studios, record companies, independent film producers, television networks, sports leagues etc., iviewit's technologies means that

video streaming can finally become a revenue source. Most of these firms have already begun to stream promotional clips over the Internet. Few, if any, have monetized their content. The reason is simple; consumers will not pay for the small screen, grainy content prevalent on the web today, and the pipeline required for serving these files is expensive. iviewit's technologies provides a solution for both these issues by enhancing already produced videos to become full-screen video quality streams and reducing the digital stream size required to serve them. These solutions are at the core of iviewit's competitive market advantage.

Imaging Overview

Companies are rapidly adopting the use of digital imaging to effectively promote their products on their web sites. Digital imaging provides businesses with a powerful, cost-effective medium to maximize the impact of their web sites; however, most of the images remain flat two-dimensional images offering a limited field of view. Technological innovations that enhance realism and interactivity and contribute to a viewer's retention to that web site should facilitate the success of e-commerce by leading to increased sales and advertising rates. Specifically, immersive imaging, or the ability to enjoy the viewing perspective of being inside the image, is becoming increasingly popular with many web sites and webmasters. However, image creation with many of the existing immersive technologies is labor intensive, produces poor visual quality and requires proprietary hardware and software. As a result, market acceptance of these technologies has been limited. Until iviewit's digital imaging process the users ability to zoom into a picture or virtual reality environment was limited due to pixel distortion.

In order for widespread adoption of immersive imaging by businesses and consumers to occur, new immersive technologies must compete with iviewit standards such as:

- Ease of creating and viewing an image
- Ease of distributing and sharing the image
- "Scan, Pan and Zoom" Capabilities
- Cost effectiveness
- Use of standardized technology
- Platform independence

Competitors

iviewit is the leadership company providing video streaming that delivers a rich video experience with virtually distortion-free, full screen capability at normal, TV-equivalent frame rates of 29.97 fps (frames per second) and providing rich images over the Internet. Similarly, iviewit is the first and only company to provide virtual imaging that preserves and delivers full image quality and detail of the original image - without distortion - not only during compression (up to 100:1), but also through high resolution zoom and magnification.

iviewit has established a first mover advantage and created significant barriers to entry through the Company's patent portfolio and trade secrets. In accomplishing these technical breakthroughs, iviewit has accomplished what engineers previously thought unachievable under current bandwidth limitations. iviewit's two-year development investment gives it significant lead-time in this space providing a significant competitive advantage in development time.

The early customer validation that iviewit has achieved will likely generate and enable additional market momentum, not only establishing iviewit's breakthrough technologies as unique, but also underscoring and confirming it as the "gold standard" for video/audio streaming and imaging over the Internet.

However, iviewit is not the only company to provide video/audio streaming and immersive imaging solutions although it is important to understand that iviewit has proprietary processes

that differentiate it from other providers. The development of iviewit's proprietary technologies and techniques has been the focus of the Company's patent portfolio.

iviewit's proprietary technologies have been designed to utilize and take advantage of the burgeoning availability and use of broadband (100-700 Kbps spectrum) using existing browsers and players (e.g., Real Player, Media Player and Quick Time); other known efforts at video/audio streaming and imaging that were developed for these bandwidths produced results associated with dial-up modem capabilities. iviewit technologies have accomplished previously unachieved quality and features in streaming audio and video, with the intent and capability to drive these advantages downward (from the "sweet-spot," or most efficiently used broadband zone: 150+ Kbps) to the dial-up range. The result is improved quality even at low bandwidths. In comparison, the competition's attempts to improve the quality of streaming video have resulted in significant limitations and compromises such as reduced frame rates, small screen display, and herky-jerky video with "kung-fu" movie-like audio overlays.

What is the current and near term real competition in both streaming and imaging for iviewit and what are the metrics and differentiators?

Video

The three companies most frequently compared to iviewit are Loudeye, Sonic Foundry and EncodeThis!. In addition to these encoding specialists, iviewit can anticipate competition from some of the companies in the hosting and serving space like Akamai and Digital Island. iviewit expects to compete with the encoding specialists on the basis of quality. iviewit will also differentiate itself from the competition by providing application solutions for specific markets like distance learning. iviewit regards the major players in the hosting & serving sector as likely partners going forward. Their core competency and business model focus is on the storage and delivery of content. As evidenced by Akamai's purchase of Intervu, these infrastructure players are likely to be acquisitive or look to ally with the stronger technology partners.

Imaging

In the imaging marketplace, the three companies most frequently compared to iviewit are IPIX, MGI software and Xippix.

IPIX

1. Virtual Tours: This product utilizes a "fish-eye" photographic lens to capture a 360° image of a scene. The IPIX solution results in images with severe distortion and limited magnification. Additionally, their solution takes a "one-size-fits-all" approach by limiting their tours to only one option – a 360° view. Their success in the residential real estate market can be explained by the fact that the usefulness of this inferior "limited" imaging technology is "good enough" to help a real estate buyer to narrow the choices from many properties to several before a final purchase decision is made in person. The product offered by IPIX is a low-end solution and not direct competition for iviewit. The travel/hotel/resort industries provide excellent examples of businesses that must capture a viewer's eye and emotion through their online photographs and virtual tours. These companies require the quality and flexibility of the iviewit solution.
2. Rimfire Dynamic Imaging: This product displays a series of photographs designed to provide a viewer with the ability to see a product from several angles. This multi-frame "slideshow" offers no ability to pan or zoom and is simply a series of static photographs. iviewit's object modeling solution provides a seamless rotation of an object and the ability to zoom in and inspect the product at any time. Retailers and auction companies are afforded greater image quality and display flexibility with the iviewit solution.

3. Movies: This product combines a "fish-eye" lens with a video camera and allows the user to choose the viewing perspective. While this is an interesting idea, the chief drawback to its adoption is the requirement that the content be filmed specifically for this application. This is a significantly limiting factor since existing content cannot be repurposed for this application and conventional video shoots must now be duplicated in order to utilize this solution. Additionally, a visit to the IPIX website reveals that none of the IPIX movie streams actually play.

MGI Software and Xippix

These companies offer a suite of imaging applications that offer similar capabilities. The chief differences between the product offerings from these firms and iviewit's products can be explained by focusing on two display components:

- Transmission of digital information
iviewit offers the only solution that does not require the continual transmission of data from the server to the user's computer to enable the zooming and panning functionality. This is a significant advantage especially for users connected at slower speeds. Each time a user zooms into or pans around on an MGI or Xippix image, the user's display screen must redraw the image. A user's interaction with an iviewit image results in fluid movement and clarity of image at all times.
- Image viewing window
Since MGI and Xippix must redraw the screen each time the user manipulates an image, the image viewing window must be small in order to limit the total number of pixels that must redraw. Conversely, since iviewit's images do not require the re-transmission of data when images are manipulated by a user, the size of the image viewing window does not affect the performance of the viewing experience.

What is the perception of competition to iviewit's technology?

iviewit's technologies enable B2B and B2C sites. The casual web surfer may perceive certain destination sites as competitors when, in fact, they are customers. Hollywood.com is an excellent example of an iviewit client that might appear to be a competitor. The highest visibility sites are businesses that are attempting to monetize content through a pay-per-view or advertising model (e.g. Vidnet, iFilm, MTVi). Their business is dependent upon professional encoding and end-to-end applications service providers, like iviewit, for their success. Similarly, the companies providing the standard players for streaming media (Microsoft, Real NetworksPlayer and AppleQuicktime) do not directly compete with iviewit. They provide the necessary player interfaces that allow a computer user to play the iviewit files.

Very few companies will likely find it economically feasible to invest in the systems and talent necessary to provide these visual solutions in-house. Sophisticated processes and systems configurations together with an environment of rapidly changing standards and innovation combine to create significant barriers for the do-it-yourselfers to create this visual content for themselves.

What is the Company's business strategy to deal with future competitive technologies to maintain competitive advantage?

The critical issues for iviewit regarding competition relate to what are the important technology issues going forward, where the industry is moving, and what are the most important areas for future research and development to maintain a competitive initiative.

The encoding procedure itself and the evolution recently of many "encoding farms" is not a solution, but simply a function of immediate demand. Going forward, significant emphasis will be focused upon the steps that occur before encoding (i.e. pre-processing for both internet and broadcasting), the enhancement of existing MPEG 2 format, and variations of MPEG-4 to improve it. Because iviewit is a "process technology" with pending patents focused on efficiency equations, the many applications for this technology are just now being recognized. Improvements in all three areas cited above will likely become a core area for new technology

in the future. Significant effort by iviewit in the development of research to improve and expand its processes and new uses for the efficiency equation are being now extensively explored in collaboration with others. The Company expects many further patents, improvements in existing pending patents, and a broad "protective shield" for many new and future applications will be a focus for the Company. The industry should move toward improvements pre-encoding, the development of internal efficiencies for encoding and codec formats, and new advances in broadband delivery in the future. iviewit expects to focus upon collaborative strategic relationships in research and marketing channels to continue to position and protect its intellectual properties.

As the industry discovers new applications, as "hot technology segments" appear and as competitors emerge in each space, iviewit expects to emphasize its role as an innovator and deliverer of solutions to the marketplace with focus upon improving the performance and cost characteristics of its business environment.

For small entities that develop competitive technologies that become a "hot spot", iviewit may either acquire the technology or possibly acquire the competition. For larger companies that provide a new competitive technology or "hot spot" in iviewit's product and marketing space, collaborations, strategic alliances and licensing are traditional tools.

Primarily, iviewit must lead in continual research and development, and employ capital and resources to maintain its prominence as a technology platform for all areas that become a part of its offerings in the marketplace.

iviewit expects to continue to aggressively develop its technologies, applications and its patent pool and forge strategic R&D relationships to help ensure its position as a leading provider of visual solutions. Strategic investments and acquisitions are also anticipated.

VII. FINANCIAL PROJECTIONS

Video processing is priced at \$5/min with an average of 4 formats per video. Hosting and serving is priced at \$50/GB per month and \$30/GB per month, respectively. The Company expects to serve 70% of the processed video minutes and to host 25% of the clients' videos. The video revenue model assumes each video to consist of 2-5 minutes of source material varying with segment (music, magazines, studios, sports, other). The Company expects to be servicing 48 video customers within four quarters of this financing. Based on the above assumptions, this represents 380GB of encoded video and 6,385GB served for these customers. See page 14-16 of the Detailed Financial Model in the Appendix for further information.

Imaging is modeled much the same as video. The Company assumes \$3/image for processing, but hotels/resorts are priced per property at \$7,800/property. Monthly hosting and serving is priced at \$149/property for hotels/resorts. General hosting/serving is priced the same as video on a per GB basis. One-time set-up fees of \$1,500 are charged as well. The Company assumes a licensing fee of \$112,500 for the first year and \$84,375 for subsequent years. See page 17-19 of the Detailed Financial Model in the Appendix for further information.

The revenue projections are as follows:

Figure 12
Projected Revenues

Video	Year 1	Year2	Year3
Encoding	\$564,435	\$5,305,221	\$14,202,070
Archival	\$98,465	\$1,189,155	\$4,851,618
Hosting	\$19,913	\$215,011	\$729,939
Serving	\$302,115	\$4,343,611	\$19,594,573
Master Licensing	\$675,000	\$3,431,250	\$3,993,750
Web Design & Consulting	\$113,100	\$480,600	\$458,400
Video Total by Year	\$1,659,929	\$14,484,248	\$43,371,950
Imaging			
Annual License Fee Revenue	\$21,000	\$150,500	\$323,500
Setup Fee Revenue	\$60,000	\$147,000	\$84,000
Hotel & Resort Packages Revenue	\$85,800	\$343,200	\$202,800
Image Processing Revenue	\$576,387	\$3,102,735	\$5,811,171
Master License Revenue	\$787,500	\$3,178,125	\$3,965,625
Hosting Revenue	\$22,775	\$180,002	\$516,868
Serving Revenue	\$232,529	\$2,290,568	\$7,860,524
Hosting & Serving Revenue for Hotels & Resorts	\$9,387	\$65,709	\$132,759
Archival	\$45,942	\$372,823	\$1,089,549
Web Design & Consulting	\$138,000	\$462,000	\$472,200
Imaging Total by Year	\$1,979,320	\$10,292,662	\$20,458,996
Grand Total by Year	\$3,639,248	\$24,776,909	\$63,830,946

Figure 13
Projected Revenue Breakdown

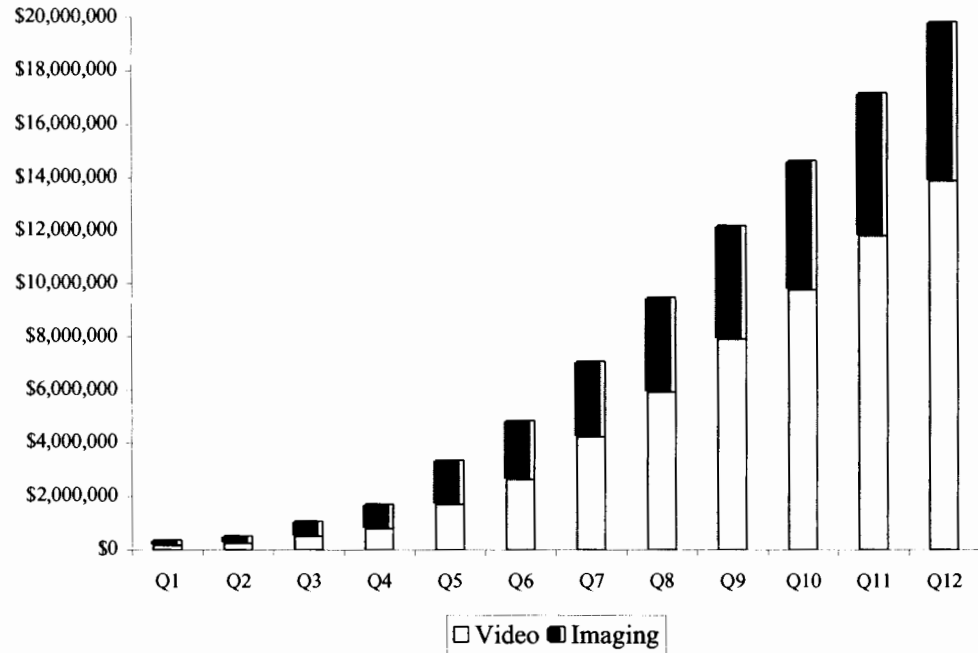

Figure 14
Projected Video Revenue Breakdown

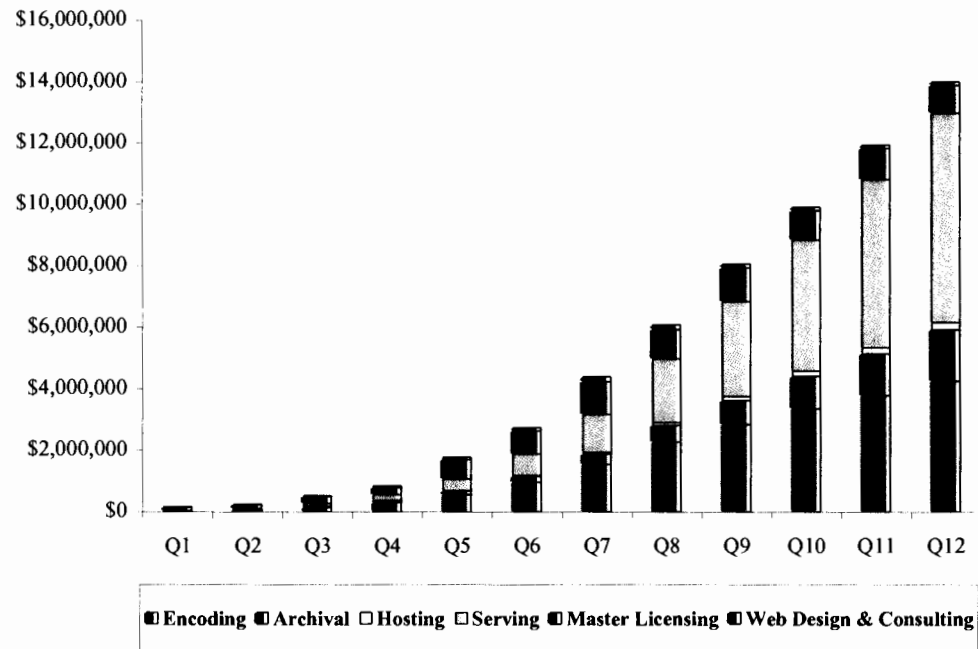

Figure 15
Projected Imaging Revenue Breakdown

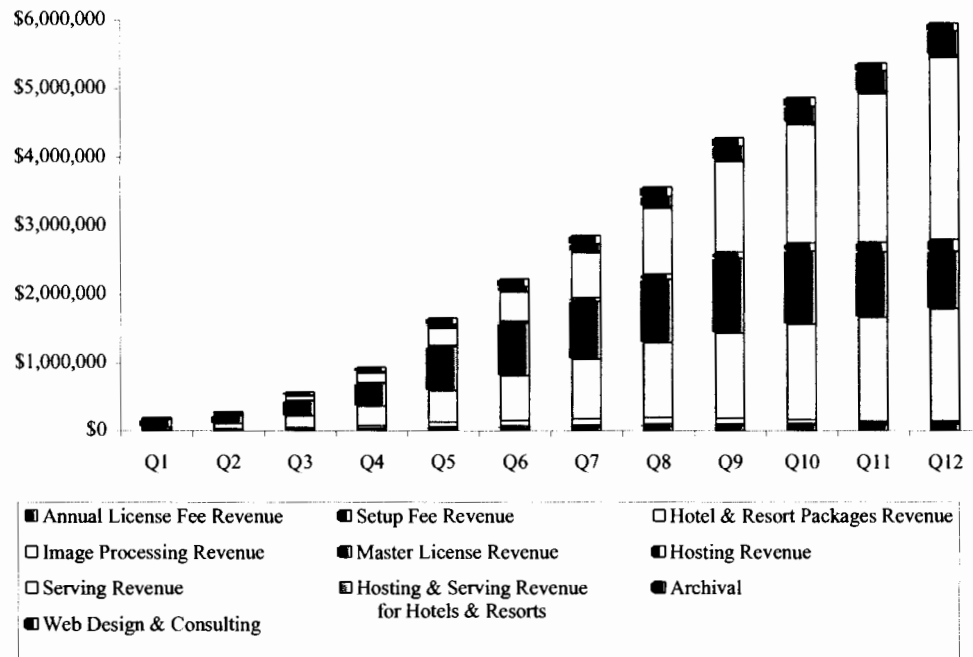

Figure 16
Projected Income Statement

	YEAR 1	YEAR 2	YEAR 3
REVENUE	\$ 3,639,248	\$ 24,776,909	\$ 63,830,946
COST OF GOODS SOLD	2,057,453	6,617,445	13,192,434
GROSS PROFIT	1,581,796	18,159,464	50,638,512
OPERATING EXPENSES:			
SELLING, GENERAL, & ADMINISTRATIVE	9,861,781	13,870,983	24,790,101
RESEARCH AND DEVELOPMENT	776,326	1,705,086	2,686,204
TOTAL OPERATING EXPENSES	10,638,107	15,576,069	27,476,305
OPERATING PROFIT (LOSS)	(9,056,311)	2,583,395	23,162,207
NET INCOME (LOSS)	\$ (9,157,644)	\$ 2,364,062	\$ 16,378,757
EARNINGS BEFORE INCOME TAXES, DEPRECIATION AND AMORTIZATION	\$ (8,860,499)	\$ 3,871,945	\$ 26,610,280



iviewit Holdings, Inc.

Projected Financial Statements

For the Three Years

From Expansion of Operations

(January 1, 2001)

iviewit Holdings, Inc.
TABLE OF CONTENTS
FOR THE THREE YEARS FROM EXPANSION OF OPERATIONS

	<u>PAGE</u>
ACCOUNTANT'S COMPILATION REPORT	3
COMPILED FINANCIAL STATEMENTS:	
Statements of Projected Balance Sheets	4
Statements of Projected Operations and Earnings Before Income Taxes, Depreciation and Amortization	5
Statements of Projected Cash Flows	6
Summary of Significant Projection Assumptions and Accounting Policies	7-9
SUPPLEMENTAL PROJECTION INFORMATION	
Statements of Projected Operations by Month	10-12
Statements of Projected Cash Flow by Month	13-15
Significant Revenue Assumptions – Exhibit 1 – Video Assumptions	16-17
Significant Revenue Assumptions – Exhibit 2 – Video Revenue	18
Significant Revenue Assumptions – Exhibit 3 – Imaging Assumptions	19-20
Significant Revenue Assumptions – Exhibit 4 – Imaging Revenue	21
Projected Total Revenue	22
Projected Cost of Goods Sold	23-24
Projected Corporate and Research & Development Expense	25-26
Projected Marketing and Sales Expense	27
Projected Fixed Asset and Depreciation Schedule	28
Projected Accounts Receivable by Month	29-31
Projected Accounts Payable by Month	32-34

GOLDSTEIN LEWIN & CO.
Certified Public Accountants and Consultants

ACCOUNTANT'S REPORT

Board of Directors
iviewit Holdings, Inc.
Boca Raton, Florida

We have compiled the accompanying statements of projected balance sheets of iviewit Holdings, Inc., for each of the three years from expansion of operations (January 1, 2001) and the related statements of projected operations, cash flows and supplemental projection information for each of the three years then ending in accordance with standards established by the American Institute of Certified Public Accountants.

The accompanying projected statements, supplemental projected information, and this report were prepared to assist the Company in obtaining equity financing and should not be used for any other purpose.

A compilation is limited to presenting, in the form of a projected financial statement and supplemental projection information, information that is the representation of management and does not include evaluation of the support for the assumptions underlying the projection. We have not examined the projected financial statements and supplemental projection information and, accordingly, do not express an opinion or any other form of assurance on the accompanying projected statements, supplemental projection information or assumptions. Furthermore, even if the hypothetical assumptions described in Note 1 materialize, there will usually be differences between the projected and actual results, because events and circumstances frequently do not occur as expected, and those differences may be material. We have no responsibility to update this report for events and circumstances occurring after the date of this report.

We are not independent with respect to iviewit Holdings, Inc.

/s/ GOLDSTEIN LEWIN & CO.

Boca Raton, Florida
September 1, 2000

1900 Northwest Corporate Blvd. E300
Boca Raton, Florida 33431
Tel: 561.994.5050

Broward 954.429.8555
Dade 305.944.3582
Palm Beach 561.737.0309

Ft. Lauderdale Office
315 SE 7th Street, 2nd Floor
Ft. Lauderdale, FL 33301

iviewit Holdings, Inc
STATEMENTS OF PROJECTED BALANCE SHEETS
YEARS ENDING FROM EXPANSION OF OPERATIONS (JANUARY 1, 2001)

See Accompanying Accountant's Compilation Report and Summary
of Significant Projection Assumptions and Accounting Policies

iviewit Holdings, Inc
STATEMENTS OF PROJECTED OPERATIONS AND
EARNINGS BEFORE INCOME TAXES, DEPRECIATION AND AMORTIZATION
FOR THE THREE YEAR PERIOD FROM EXPANSION OF OPERATIONS (JANUARY 1, 2001)

See Accompanying Accountant's Compilation Report and Summary
of Significant Projection Assumptions and Accounting Policies

iviewit Holdings, Inc
SUMMARY OF SIGNIFICANT PROJECTION
ASSUMPTIONS AND ACCOUNTING POLICIES

NOTE 1: NATURE AND LIMITATIONS OF PROJECTIONS

The accompanying projected financial statements present, in accordance with generally accepted accounting principals and to the best of management's knowledge and belief, iviewit Holdings, Inc.'s (the "Company") expected balance sheets as of the end of each projection period and the expected results of its operations and earnings before income taxes, depreciation and amortization and its cash flows for the projection periods, based upon a hypothetical assumption. It has been assumed that equity financing of \$20,000,000 will be obtained from venture capital sources. The operational revenue and expenses have been based upon the collective experience of management in operating other companies, as well as an evaluation of companies in similar industries. The projected statements reflect management's judgment at September 1, 2000, the date of these projections, of the expected conditions and the expected course of action if the hypothetical assumption materializes. Because events and circumstances frequently do not occur as expected, even if the hypothetical assumption materializes, there will usually be differences between projected and actual results, and those differences may be material.

Following a period of technology development, the Company commenced operations in July 1999. Actual commercialization began early this year, and the Company's first revenue producing customers initiated in the second quarter of 2000. The Company has developed a production department to service current and active prospective customers. A V.P. of Operations was engaged in June, 1999, and the Company is committed to maintaining a production capability at all times that anticipates its future needs; in that respect, the accompanying projected financial statements rely on that philosophy whereby there should be no production lag time in the Company's ability to accommodate and service new clients.

Since commencing operations, the Company has raised approximately \$3 million to fund its activities. As of this date, the Company has approximately \$300,000 in bank accounts. In addition to the \$20 million capital raise contemplated in these projections, the Company currently is attempting to raise an additional interim amount of up to \$3 million. If successful, such additional funding may leave a cash balance not required for operations at the time of the \$20 million funding (December 2000). However, such possible cash balance has not been contemplated in the projected financial statements herein.

The following is a summary of assumptions that the developer believes are significant to the projection and schedules providing additional information about the items discussed.

NOTE 2: NATURE OF OPERATIONS DURING THE PROJECTION PERIOD

The Company is seeking an equity investment of \$20,000,000 to aggressively commercialize its proprietary video/audio streaming and digital imaging technologies that provide Internet infrastructure capabilities for any e-commerce application. The Company has set up offices and a production facility in Boca Raton, Florida and additional offices are contemplated in locations which can capitalize on key market applications, beginning with Los Angeles, Chicago and New York. Potential clients for the imaging and digital video encoding services include: entertainment and media, hotel and resort properties, auctions and collectibles, advertising, automotive, healthcare, executive search, and modeling industries. The Company will expand operations as soon as this equity financing is received. The Company plans to recruit a CEO, CMO and additional managers, technicians, sales and administrative personnel during the projection period. In addition, the Company will be continuing to purchase computers, software, office equipment and furnishings. It is anticipated that \$921,438 of computers, furniture and other equipment will be purchased in the first year, \$3,664,811 in the second year and an additional \$7,025,770 in the third year.

NOTE 3: ACCOUNTS PAYABLE

Accounts payable consists of expenses, payroll, sales commissions and income taxes. Payroll is payable bi-weekly as earned. Sales commissions are payable semi-monthly in arrears. Income taxes are payable in the

iviewit Holdings, Inc
SUMMARY OF SIGNIFICANT PROJECTION
ASSUMPTIONS AND ACCOUNTING POLICIES

NOTE 3: ACCOUNTS PAYABLE (Continued)

month following the liability. All other expenses have been determined to be payable partially within 30 days and the balance within 60 days. Management has projected the percentages payable for each of the years as follows: year 1 80/20, year 2 60/40, and year 3 50/50.

NOTE 4: REVENUE

The total revenue stream is based upon the licensing, processing, hosting, archiving and streaming of video/audio and digital images on the Internet in addition to web design and consulting revenue. For each client, the revenue is based upon license fees, video or image size and the nature and number of items processed. Growth factors are based upon the proliferation of broadband, the experience the Company has gained from the initial commercialization of its products and services, as well as management's research of companies in similar industries. Revenue is calculated quarterly and recognized monthly at 31.75%, 33.25% and 35.00% across the quarter. Revenue is projected to be collected 30% within 1-30 days, 40% within 31-60 days, 20% within 61 to 90 days, 6% within 91-120 days and 4% as an estimate for bad debt.

NOTE 5: EXPENSES OTHER THAN DEPRECIATION

Substantially all of the expenses for the varying expected revenue levels are based upon management's research of existing Internet companies and the business experience of the individual management team members.

The following summarizes significant assumptions for projected expenses and other items:

- A. Cost of goods sold is based upon the per unit cost of production and an allocation of the production related operating expenses. The following are the allocation percentages, by facility and department:

Allocation Matrix				
Facility	Corporate	R&D	Production	Marketing
Boca Raton	35%	10%	25%	30%
Los Angeles	5%	0%	45%	50%
New York	5%	0%	45%	50%
Chicago	5%	0%	45%	50%

- B. Rent expense is based upon an office in Boca Raton, Florida and three additional offices to be established in quarters two, four and six.
- C. Payroll expense is based upon the annual salaries of the various different classifications of employees which management projects will be required. Employee Benefits are projected at 25% of total salaries.
- D. Advertising and Trade Shows is projected to be \$2,390,000 in year 1, \$1,990,000 in year 2 and \$1,790,000 in year 3.
- E. Legal and Accounting Fees (Outside Counsel), excluding annual audit fees, are projected to be \$72,000 per year. Audit Fees are projected to be \$65,000 in year 1, \$100,000 in year 2 and \$135,000 in year 3.
- F. Contract work related to production is projected to be \$180,500 in year 1, \$413,921 in year 2 and \$487,033 in year 3.

iviewit Holdings, Inc
SUMMARY OF SIGNIFICANT PROJECTION
ASSUMPTIONS AND ACCOUNTING POLICIES

NOTE 5: EXPENSES OTHER THAN DEPRECIATION (CONTINUED)

- G. Consulting Expense is projected to be \$216,000 per year.
- H. Aggregate Sales Commissions for inside sales persons and outside referrals are projected to be 15% of collected revenue and are payable semi-monthly in arrears.
- I. Network Support Costs are allocated 65% to projected marketing expense, 25% to projected corporate expense and 10% to projected research and development expense.
- J. An Investment Banking Fee of \$ 1,200,000 is projected to be paid in the first month.
- K. All other expenses are based on projected revenue increases taking into account economies of scale in accordance with management's experience.

NOTE 6: INCOME TAXES

Income taxes have been provided for at 40% of net income in the period when prior losses are exceeded.

NOTE 7: DEPRECIATION

Depreciation is computed using straight-line methods over the useful life of the assets as follows:

<u>Type of Asset</u>	<u>Useful Life</u>
Software	3 years
Computers and Video Equipment	3 years
Telephone System	5 years
Furniture, Fixtures, and Equipment	5 years

Ivewit Holdings, Inc.
STATEMENTS OF PROJECTED REVENUE AND EXPENSES
FOR THE FIRST YEAR FROM EXPANSION OF OPERATIONS

	Jan-01	Feb-01	Mar-01	Apr-01	May-01	Jun-01	Jul-01	Aug-01	Sep-01	Oct-01	Nov-01	Dec-01	TOTAL
REVENUE:													
Video Streaming	\$49,967	\$52,327	\$55,081	\$72,891	\$76,335	\$80,352	\$156,244	\$163,626	\$172,237	\$247,926	\$259,639	\$273,304	\$1,659,929
Imaging	\$62,208	\$65,147	\$68,575	\$88,040	\$92,199	\$97,052	\$180,735	\$189,274	\$199,236	\$297,451	\$311,504	\$327,899	1,979,320
Total Revenue	\$112,174	\$117,474	\$123,657	\$160,931	\$168,534	\$177,404	\$336,979	\$352,899	\$371,473	\$545,378	\$563,143	\$601,204	\$3,639,248
COST OF GOODS SOLD	107,549	112,630	118,558	145,530	152,406	160,427	170,780	178,849	188,262	229,381	240,218	252,861	2,057,453
		338,737			458,364			537,891			722,461		
GROSS PROFIT (LOSS)	4,625	4,844	5,099	15,400	16,128	16,977	166,199	174,051	183,211	315,996	330,925	348,342	1,581,796
OPERATING EXPENSES:													
Marketing Expense	\$441,371	\$462,223	\$486,551	\$470,071	\$492,279	\$518,189	\$480,944	\$503,666	\$530,175	\$536,075	\$561,401	\$590,949	\$6,073,894
Corporate Expense	595,268	595,268	595,268	195,588	195,588	195,588	207,404	207,404	207,404	264,370	264,370	264,370	3,787,887
R&D Expense	49,899	49,899	49,899	66,776	66,776	66,776	66,656	66,656	66,656	75,445	75,445	75,445	776,326
	\$1,086,538	\$1,107,390	\$1,131,717	\$732,434	\$754,643	\$780,552	\$755,004	\$777,726	\$804,234	\$875,890	\$901,216	\$930,764	\$10,638,107
OPERATING PROFIT (LOSS)	(1,081,912)	(1,102,546)	(1,126,618)	(717,034)	(738,515)	(763,575)	(588,805)	(603,675)	(621,023)	(559,894)	(570,291)	(582,422)	(9,056,311)
Depreciation Expense	8,444	8,444	8,444	8,444	8,444	8,444	8,444	8,444	8,444	8,444	8,444	8,444	101,333
INCOME BEFORE TAXES	(\$1,090,357)	(\$1,110,990)	(\$1,135,063)	(\$725,479)	(\$746,959)	(\$772,020)	(\$597,250)	(\$612,120)	(\$629,468)	(\$568,338)	(\$578,736)	(\$590,866)	(\$9,157,644)
INCOME TAXES	0	0	0	0	0	0	0	0	0	0	0	0	0
NET INCOME	(\$1,090,357)	(\$1,110,990)	(\$1,135,063)	(\$725,479)	(\$746,959)	(\$772,020)	(\$597,250)	(\$612,120)	(\$629,468)	(\$568,338)	(\$578,736)	(\$590,866)	(\$9,157,644)

Ivewit Holdings, Inc.
STATEMENTS OF PROJECTED REVENUE AND EXPENSES
FOR THE SECOND YEAR FROM EXPANSION OF OPERATIONS

	Jan-02	Feb-02	Mar-02	Apr-02	May-02	Jun-02	Jul-02	Aug-02	Sep-02	Oct-02	Nov-02	Dec-02	TOTAL
REVENUE:													
Video Streaming	\$539,866	\$565,371	\$595,127	\$834,718	\$874,153	\$920,161	\$1,344,368	\$1,407,881	\$1,481,980	\$1,879,798	\$1,968,607	\$2,072,218	\$14,484,248
Imaging	\$523,699	\$548,441	\$577,306	\$705,418	\$738,745	\$777,626	\$906,700	\$949,536	\$999,512	\$1,132,103	\$1,185,588	\$1,247,987	10,292,662
Total Revenue	\$1,063,564	\$1,113,812	\$1,172,433	\$1,540,136	\$1,612,898	\$1,697,788	\$2,251,068	\$2,357,417	\$2,481,492	\$3,011,901	\$3,154,195	\$3,320,205	\$24,776,909
COST OF GOODS SOLD	379,546	397,477	418,397	471,231	493,494	519,468	578,657	605,995	637,889	671,605	703,334	740,352	6,617,445
		1,195,421			1,484,193			1,822,541			2,115,290		
GROSS PROFIT	684,018	716,334	754,036	1,068,905	1,119,404	1,178,320	1,672,411	1,751,423	1,843,603	2,340,296	2,450,861	2,579,854	18,159,464
OPERATING EXPENSES:													
Marketing Expense	\$571,293	\$598,283	\$629,772	\$681,734	\$713,942	\$751,518	\$830,878	\$870,132	\$915,929	\$981,875	\$1,028,263	\$1,082,382	\$9,656,001
Corporate Expense	274,069	274,069	274,069	312,341	312,341	312,341	363,009	363,009	363,009	455,575	455,575	455,575	4,214,982
R&D Expense	102,122	102,122	102,122	155,893	155,893	155,893	155,115	155,115	155,115	155,233	155,233	155,233	1,705,086
	\$947,484	\$974,474	\$1,005,963	\$1,149,968	\$1,182,176	\$1,219,752	\$1,349,001	\$1,388,256	\$1,434,052	\$1,592,682	\$1,639,070	\$1,693,189	\$15,576,069
OPERATING PROFIT (LOSS)	(263,466)	(258,140)	(251,927)	(81,064)	(62,772)	(41,432)	323,410	363,167	409,551	747,614	811,791	886,665	2,583,395
Depreciation Expense	18,278	18,278	18,278	18,278	18,278	18,278	18,278	18,278	18,278	18,278	18,278	18,278	219,333
INCOME BEFORE TAXES	(\$281,744)	(\$276,418)	(\$270,205)	(\$99,342)	(\$81,050)	(\$59,710)	\$305,172	\$311,865	\$391,273	\$729,336	\$793,513	\$868,387	\$2,364,062

	Jan-03	Feb-03	Mar-03	Apr-03	May-03	Jun-03	Jul-03	Aug-03	Sep-03	Oct-03	Nov-03	Dec-03	TOTAL
INCOME TAXES	0	0	0	0	0	0	0	0	0	0	0	0	0
NET INCOME	(\$281,744)	(\$276,418)	(\$270,205)	(\$99,342)	(\$81,050)	(\$59,710)	\$305,132	\$344,889	\$391,273	\$729,336	\$793,513	\$868,387	\$2,364,062

Iviewit Holdings, Inc.
STATEMENTS OF PROJECTED REVENUE AND EXPENSES
FOR THE THIRD YEAR FROM EXPANSION OF OPERATIONS

	Jan-03	Feb-03	Mar-03	Apr-03	May-03	Jun-03	Jul-03	Aug-03	Sep-03	Oct-03	Nov-03	Dec-03	TOTAL
REVENUE:													
Video Streaming	\$2,514,532	\$2,633,329	\$2,771,925	\$3,104,160	\$3,250,813	\$3,421,909	\$3,748,315	\$3,925,400	\$4,132,000	\$4,403,587	\$4,611,631	\$4,854,348	\$43,371,950
Imaging	\$1,358,952	\$1,423,154	\$1,498,057	\$1,544,709	\$1,617,688	\$1,702,829	\$1,703,277	\$1,783,747	\$1,877,629	\$1,888,793	\$1,978,027	\$2,082,134	20,458,996
Total Revenue	\$3,873,483	\$4,056,483	\$4,269,982	\$4,648,870	\$4,868,501	\$5,124,738	\$5,451,592	\$5,709,147	\$6,009,629	\$6,292,380	\$6,589,658	\$6,936,482	\$63,830,946

COST OF GOODS SOLD	937,564	981,858	1,033,535	999,830	1,047,066	1,102,175	1,085,603	1,136,892	1,196,728	1,165,600	1,220,668	1,284,914	13,192,434
		2,952,956			3,149,072			3,419,223			3,671,182		
GROSS PROFIT	2,935,920	3,074,625	3,236,447	3,649,039	3,821,435	4,022,563	4,365,989	4,572,256	4,812,901	5,126,780	5,368,990	5,651,568	50,638,512

OPERATING EXPENSES:													
Marketing Expense	\$1,159,496	\$1,214,275	\$1,278,185	\$1,313,195	\$1,375,236	\$1,447,617	\$1,462,340	\$1,531,427	\$1,612,028	\$1,613,694	\$1,689,932	\$1,778,875	\$17,476,300
Corporate Expense	496,368	496,368	496,368	563,808	563,808	563,808	631,588	631,588	631,588	746,169	746,169	746,169	7,313,802
R&D Expense	222,036	222,036	222,036	224,516	224,516	224,516	224,322	224,322	224,322	224,528	224,528	224,528	2,686,204
	\$1,877,900	\$1,932,680	\$1,996,589	\$2,101,519	\$2,163,560	\$2,235,941	\$2,318,250	\$2,387,337	\$2,467,938	\$2,584,391	\$2,660,629	\$2,749,572	\$27,476,305

OPERATING PROFIT	1,058,020	1,141,945	1,239,858	1,547,520	1,657,875	1,786,622	2,047,739	2,184,919	2,344,963	2,542,389	2,708,361	2,901,996	23,162,207
Depreciation Expense	32,778	32,778	32,778	32,778	32,778	32,778	32,778	32,778	32,778	32,778	32,778	32,778	393,333

INCOME BEFORE TAXES	\$1,025,242	\$1,109,167	\$1,207,081	\$1,514,742	\$1,625,097	\$1,753,844	\$2,014,961	\$2,152,141	\$2,312,185	\$2,509,611	\$2,675,584	\$2,869,218	\$22,768,874
---------------------	-------------	-------------	-------------	-------------	-------------	-------------	-------------	-------------	-------------	-------------	-------------	-------------	--------------

INCOME TAXES	0	0	0	0	0	576,636	805,984	860,857	924,874	1,003,844	1,070,233	1,147,687	6,390,116
NET INCOME	\$1,025,242	\$1,109,167	\$1,207,081	\$1,514,742	\$1,625,097	\$1,177,208	\$1,208,977	\$1,291,285	\$1,387,311	\$1,505,767	\$1,605,350	\$1,721,531	\$16,378,757

Iviewit Holdings, Inc.
**STATEMENTS OF PROJECTED CASH FLOWS - BY MONTH
 FOR THE FIRST YEAR FROM EXPANSION OF OPERATIONS**

	Jan-01	Feb-01	Mar-01	Apr-01	May-01	Jun-01	Jul-01	Aug-01	Sep-01	Oct-01	Nov-01	Dec-01	TOTAL
CASH FLOWS FROM OPERATING ACTIVITIES:													
NET INCOME(LOSS)													
ADJUSTMENTS:													
DEPRECIATION	24,762	24,762	24,762	24,762	24,762	24,762	24,762	24,762	24,762	24,762	24,762	24,762	297,146
(INCREASE)DECREASE IN ACCOUNTS RECEIVABLE	(112,174)	(83,821)	(43,545)	(54,409)	(36,080)	(30,480)	(176,492)	(135,991)	(84,915)	(214,381)	(161,759)	(115,604)	(1,249,651)
INCREASE (DECREASE) IN ACCOUNTS PAYABLE	117,628	4,342	5,066	(2,290)	4,651	5,426	1,210	5,117	5,969	24,752	6,398	7,465	185,734
CASH PROVIDED BY (USED IN) OPERATING ACTIVITIES	(1,060,141)	(1,165,707)	(1,148,780)	(757,416)	(753,626)	(772,312)	(747,769)	(718,231)	(683,651)	(733,205)	(709,334)	(674,243)	(9,924,415)
CASH FLOWS FROM INVESTING ACTIVITIES:													
PAYMENTS FOR FIXED ASSETS	(99,269)	(99,269)	(99,269)	(45,814)	(45,814)	(45,814)	(46,862)	(46,862)	(46,862)	(115,200)	(115,200)	(115,200)	(921,438)
CASH USED IN INVESTING ACTIVITIES	(99,269)	(99,269)	(99,269)	(45,814)	(45,814)	(45,814)	(46,862)	(46,862)	(46,862)	(115,200)	(115,200)	(115,200)	(921,438)
CASH FLOWS FROM FINANCING ACTIVITIES:													
PROCEEDS FROM INVESTOR FINANCING	20,000,000	0	0	0	0	0	0	0	0	0	0	0	20,000,000
CASH PROVIDED BY FINANCING ACTIVITIES	20,000,000	0	0	0	0	0	0	0	0	0	0	0	20,000,000
INCREASE(DECREASE) IN CASH	18,840,590	(1,264,976)	(1,248,049)	(803,230)	(799,441)	(818,126)	(794,631)	(765,093)	(730,513)	(848,405)	(824,535)	(789,443)	9,154,147
CASH - BEGINNING	0	18,840,590	17,575,614	16,327,565	15,524,335	14,724,894	13,906,768	13,112,137	12,347,044	11,616,531	10,768,125	9,943,591	0
CASH - ENDING	\$18,840,590	\$17,575,614	\$16,327,565	\$15,524,335	\$14,724,894	\$13,906,768	\$13,112,137	\$12,347,044	\$11,616,531	\$10,768,125	\$9,943,591	\$9,154,147	\$9,154,147

Iviewit Holdings, Inc.
**STATEMENTS OF PROJECTED CASH FLOWS - BY MONTH
 FOR THE SECOND YEAR FROM EXPANSION OF OPERATIONS**

	Jan-02	Feb-02	Mar-02	Apr-02	May-02	Jun-02	Jul-02	Aug-02	Sep-02	Oct-02	Nov-02	Dec-02	TOTAL
CASH FLOWS FROM OPERATING ACTIVITIES:													
NET INCOME(LOSS)													
ADJUSTMENTS:													
DEPRECIATION	125,657	125,657	125,657	125,657	125,657	125,657	125,657	125,657	125,657	125,657	125,657	125,657	1,507,883
(INCREASE)DECREASE IN ACCOUNTS RECEIVABLE	(522,639)	(400,353)	(257,324)	(492,894)	(376,813)	(294,539)	(715,854)	(573,286)	(434,598)	(769,010)	(629,349)	(527,189)	(5,993,849)
INCREASE (DECREASE) IN ACCOUNTS PAYABLE	148,237	12,246	14,287	56,861	15,480	18,060	69,564	19,800	23,100	70,552	23,924	27,912	500,024
CASH PROVIDED BY (USED IN) OPERATING ACTIVITIES	(530,489)	(538,868)	(387,585)	(409,717)	(316,726)	(210,531)	(215,501)	(82,940)	105,432	156,535	313,745	494,766	(1,621,879)
CASH FLOWS FROM INVESTING ACTIVITIES:													
PAYMENTS FOR FIXED ASSETS	(158,084)	(158,084)	(158,084)	(292,609)	(292,609)	(292,609)	(316,915)	(316,915)	(316,915)	(453,995)	(453,995)	(453,995)	(3,664,811)
CASH USED IN INVESTING ACTIVITIES	(158,084)	(158,084)	(158,084)	(292,609)	(292,609)	(292,609)	(316,915)	(316,915)	(316,915)	(453,995)	(453,995)	(453,995)	(3,664,811)
CASH FLOWS FROM FINANCING ACTIVITIES:													
PROCEEDS FROM INVESTOR FINANCING	(528,174)	(5276,418)	(5270,205)	(599,342)	(581,050)	(559,710)	\$305,132	\$344,889	\$391,273	\$729,336	\$793,513	\$868,387	\$2,364,062
CASH PROVIDED BY FINANCING ACTIVITIES	(528,174)	(5276,418)	(5270,205)	(599,342)	(581,050)	(559,710)	\$305,132	\$344,889	\$391,273	\$729,336	\$793,513	\$868,387	\$2,364,062
INCREASE(DECREASE) IN CASH	125,657	125,657	125,657	125,657	125,657	125,657	125,657	125,657	125,657	125,657	125,657	125,657	1,507,883
CASH - BEGINNING	0	18,840,590	17,575,614	16,327,565	15,524,335	14,724,894	13,906,768	13,112,137	12,347,044	11,616,531	10,768,125	9,943,591	0
CASH - ENDING	\$18,840,590	\$17,575,614	\$16,327,565	\$15,524,335	\$14,724,894	\$13,906,768	\$13,112,137	\$12,347,044	\$11,616,531	\$10,768,125	\$9,943,591	\$9,154,147	\$9,154,147

	Jan-03	Feb-03	Mar-03	Apr-03	May-03	Jun-03	Jul-03	Aug-03	Sep-03	Oct-03	Nov-03	Dec-03	TOTAL
PROCEEDS FROM INVESTOR FINANCING	0	0	0	0	0	0	0	0	0	0	0	0	0
CASH PROVIDED BY FINANCING ACTIVITIES	0	0	0	0	0	0	0	0	0	0	0	0	0
INCREASE(DECREASE) IN CASH	(688,573)	(696,952)	(545,669)	(702,326)	(609,335)	(503,140)	(532,417)	(399,856)	(211,484)	(297,460)	(140,250)	40,771	(5,286,690)
CASH - BEGINNING	9,154,147	8,465,575	7,768,622	7,222,954	6,520,628	5,911,293	5,408,152	4,875,736	4,475,880	4,264,396	3,966,936	3,826,686	9,154,147
CASH - ENDING	\$8,465,575	\$7,768,622	\$7,222,954	\$6,520,628	\$5,911,293	\$5,408,152	\$4,875,736	\$4,475,880	\$4,264,396	\$3,966,936	\$3,826,686	\$3,867,457	\$3,867,457

iviewit Holdings, Inc.
**STATEMENTS OF PROJECTED CASH FLOWS - BY MONTH
FOR THE THIRD YEAR FROM EXPANSION OF OPERATIONS**

	Jan-03	Feb-03	Mar-03	Apr-03	May-03	Jun-03	Jul-03	Aug-03	Sep-03	Oct-03	Nov-03	Dec-03	TOTAL
CASH FLOWS FROM OPERATING ACTIVITIES:													
NET INCOME(LOSS)	\$1,025,242	\$1,109,167	\$1,207,081	\$1,514,742	\$1,623,097	\$1,177,208	\$1,208,977	\$1,291,285	\$1,387,311	\$1,505,767	\$1,605,350	\$1,721,531	\$16,378,757
ADJUSTMENTS:													
DEPRECIATION	320,117	320,117	320,117	320,117	320,117	320,117	320,117	320,117	320,117	320,117	320,117	320,117	3,841,406
(INCREASE)DECREASE IN ACCOUNTS RECEIVABLE	(859,511)	(733,586)	(644,659)	(764,733)	(700,011)	(699,935)	(772,257)	(755,987)	(790,405)	(797,780)	(816,093)	(887,856)	(9,222,813)
INCREASE (DECREASE) IN ACCOUNTS PAYABLE	185,656	31,034	38,539	34,094	37,254	620,099	266,012	96,876	113,022	128,079	113,110	131,962	1,797,736
CASH PROVIDED BY (USED IN) OPERATING ACTIVITIES	671,503	728,732	921,078	1,104,221	1,282,457	1,417,490	1,022,848	952,291	1,030,045	1,156,182	1,222,484	1,285,754	12,795,087

CASH FLOWS FROM INVESTING ACTIVITIES:													
PAYMENTS FOR FIXED ASSETS	(516,847)	(516,847)	(516,847)	(560,023)	(560,023)	(560,023)	(603,849)	(603,849)	(603,849)	(661,205)	(661,205)	(661,205)	(7,025,770)
CASH USED IN INVESTING ACTIVITIES	(516,847)	(516,847)	(516,847)	(560,023)	(560,023)	(560,023)	(603,849)	(603,849)	(603,849)	(661,205)	(661,205)	(661,205)	(7,025,770)

CASH FLOWS FROM FINANCING ACTIVITIES:													
PROCEEDS FROM INVESTOR FINANCING	0	0	0	0	0	0	0	0	0	0	0	0	0
CASH PROVIDED BY FINANCING ACTIVITIES	0	0	0	0	0	0	0	0	0	0	0	0	0
INCREASE(DECREASE) IN CASH	154,656	211,885	404,231	544,198	722,435	857,467	418,999	348,443	426,197	494,977	561,279	624,549	5,769,317
CASH - BEGINNING	3,867,457	4,022,113	4,233,998	4,638,229	5,182,428	5,904,862	6,762,330	7,181,329	7,529,772	7,955,969	8,450,946	9,012,225	3,867,457
CASH - ENDING	\$4,022,113	\$4,233,998	\$4,638,229	\$5,182,428	\$5,904,862	\$6,762,330	\$7,181,329	\$7,529,772	\$7,955,969	\$8,450,946	\$9,012,225	\$9,636,774	\$9,636,774

iviewit Holdings, Inc.
SIGNIFICANT REVENUE ASSUMPTIONS - EXHIBIT 1
 Video Assumptions
FOR THE THREE YEAR PERIOD

Basic Assumptions	
Video Processing (per minute)	\$5
Average # of Encoding Formats	4
Video Hosting (per GB/Mo.) (see table below)	\$50
Video Servicing (per GB) (see table below)	\$30
Percentage Served of each video	70%
% of Clients Hosting Video with iviewit	25%
First Year Annual Video Master License Fee (VML)	\$112,500
Renewal Year Annual Video Master License Fee (VML)	\$84,375
# of VML clients expressed as a % of Full-Service Clients	see table

Format	File Size (GB/min.)
avg. modem file size per minute	0.000975
avg. broadband file size per minute	0.005750
Avg. gig/min. of video for 4 formats	0.003363
Modem File Size as a % of Total	14.50%
Broadband File Size as a % of Total	85.50%

Quarter	Number of Client Accounts												New VML Clients by Quarter	Total VML Clients	Total Client Accounts	VMC Clients as a % of Full-Service Clients
	Music	Magazines	Studios	Sports	All Others											
1	1	1	1	1	2	1	1	1	1	1	1	1	1	1	7	10%
2	100%	100%	25%	75%	4	2	2	4	100%	4	2	2	2	1	14	10%
3	100%	100%	25%	75%	4	3	4	8	100%	8	4	4	4	2	27	10%
4	80%	80%	20%	65%	7	4	7	15	85%	15	6	6	6	2	48	10%
5	70%	70%	20%	55%	14	5	11	25	65%	25	11	11	11	5	80	15%
6	60%	60%	20%	45%	23	6	16	38	50%	38	17	17	17	6	123	15%
7	45%	50%	20%	35%	34	8	22	54	40%	54	25	25	25	8	178	15%
8	25%	30%	15%	30%	43	10	29	68	25%	68	32	32	32	7	228	15%
9	10%	20%	10%	15%	48	11	34	75	10%	75	38	38	38	6	262	20%
10	8%	10%	5%	10%	52	12	42	79	5%	79	42	42	42	4	285	20%
11	5%	5%	5%	5%	55	13	40	83	5%	83	45	45	45	3	302	20%
12	5%	5%	5%	5%	58	14	42	88	5%	88	48	48	48	3	320	20%

Renewal VML Clients	VMC Clients as a % of Full-Service Clients
0	10%
0	10%
0	10%
0	10%
1	15%
1	15%
2	15%
2	15%
5	20%
6	20%
8	20%
7	20%

Quarter	Average Source Minutes per Video											
	Music	Magazines	Studios	Sports	All Others							
1	3.00	3.00	5.00	2.00	3.00							
2	5%	5%	15%	15%	5%							
3	3.31	3.31	6.62	2.65	3.31							
4	5%	5%	15%	15%	5%							
5	3.66	3.66	8.77	3.51	3.66							
6	3.85	3.85	10.09	4.04	3.85							
7	4%	4%	14%	4%	4%							
8	4.18	4.18	13.24	5.31	4.18							
9	2%	2%	12%	2%	2%							
10	1%	1%	10%	1%	1%							
11	1%	1%	8%	1%	1%							
12	1%	1%	6%	1%	1%							

Quarter	Hosting, Servicing & Archiving Charges		
	Quarterly Discount	Hosting Charge	Servicing Charge
1		\$50.00	\$30.00
2	2%	\$49.00	\$29.40
3	2%	\$48.02	\$28.81
4	2%	\$47.06	\$28.24
5	2%	\$46.12	\$27.67
6	2%	\$45.20	\$27.12
7	2%	\$44.29	\$26.58
8	2%	\$43.41	\$26.04
9	2%	\$42.54	\$25.52
10	2%	\$41.69	\$25.01
11	2%	\$40.85	\$24.51
12	2%	\$40.04	\$24.02

FOR THE THREE YEAR PERIOD

Average Number of Videos per Client											
Quarter	Music		Magazines		Studios		Sports		All Others		
	Growth Factor	Avg. # of Videos per Client	Growth Factor	Avg. # of Videos per Client	Growth Factor	Avg. # of Videos per Client	Growth Factor	Avg. # of Videos per Client	Growth Factor	Avg. # of Videos per Client	
1		70		40		100		180		60	450
2	5%	74	5%	42	5%	105	5%	189	5%	63	473
3	5%	78	5%	45	5%	111	5%	199	5%	67	500
4	5%	82	5%	48	5%	117	5%	209	5%	71	527
5	5%	87	5%	51	5%	123	5%	220	5%	75	556
6	5%	92	5%	54	5%	130	5%	231	5%	79	586
7	5%	97	5%	57	5%	137	5%	243	5%	83	617
8	5%	102	5%	60	5%	144	5%	256	5%	88	650
9	2%	105	2%	62	2%	147	2%	262	2%	90	666
10	2%	108	2%	64	2%	150	2%	268	2%	92	682
11	2%	111	2%	66	2%	153	2%	274	2%	94	698
12	2%	114	2%	68	2%	157	2%	280	2%	96	715

Broadband vs. Modem Serving Ratio		
Quarter	Modem Speed	Broadband Speed
1	80.00%	20.00%
2	78.50%	21.50%
3	77.00%	23.00%
4	75.50%	24.50%
5	74.00%	26.00%
6	72.50%	27.50%
7	71.00%	29.00%
8	69.50%	30.50%
9	68.00%	32.00%
10	66.50%	33.50%
11	65.00%	35.00%
12	63.50%	36.50%

Number of Playbacks per Video Hosted										
Quarter	Music		Magazines		Studios		Sports		All Others	
	Growth Factor	# of Playbacks per Video	Growth Factor	# of Playbacks per Video	Growth Factor	# of Playbacks per Video	Growth Factor	# of Playbacks per Video	Growth Factor	# of Playbacks per Video
1		600		300		600		900		450
2	5%	630	5%	315	5%	630	5%	945	2%	459
3	5%	662	5%	331	5%	662	5%	993	2%	469
4	5%	696	5%	348	5%	696	5%	1,043	2%	479
5	4%	721	4%	361	4%	721	5%	1,096	2%	489
6	4%	747	4%	374	4%	747	5%	1,151	2%	499
7	4%	774	3%	386	3%	770	5%	1,209	2%	509
8	4%	802	2%	394	2%	786	5%	1,270	2%	520
9	2%	819	2%	402	2%	802	5%	1,334	2%	531
10	2%	836	2%	411	2%	819	5%	1,401	2%	542
11	2%	853	2%	420	2%	836	5%	1,472	2%	553
12	2%	871	2%	429	2%	853	5%	1,546	2%	565

% of Clients Hosting with Iviewit		
Quarter	Quarterly Increase	% of Clients
1		25.00%
2	1%	26.00%
3	1%	27.00%
4	1%	28.00%
5	1%	29.00%
6	1%	30.00%
7	1%	31.00%
8	1%	32.00%
9	1%	33.00%
10	1%	34.00%
11	1%	35.00%
12	1%	36.00%

Archiving	
Archival Fee/GB Stored/Month (see table above - right)	\$15
% of all encoded content that is taken offline & discarded per quarter	10%
% of all encoded content that is taken offline & Archived per quarter	15%
% of content Archived Concurrent with Encoding	40%
size of an AVI file (per minute in GB)	0.125

Web Design & Consulting Assumptions	
% of New Clients using Design Services	20%
Average Web Design Setup Fee	\$12,000
Quarterly Maintenance Fee	\$1,500

iViewit Holdings, Inc.
SIGNIFICANT REVENUE ASSUMPTIONS - EXHIBIT 2
VIDEO REVENUE PROJECTIONS
FOR THE THREE YEAR PERIOD

Item	Video Revenue by Quarter											
	Q1	Q2	Q3	Q4	Q5	Q6	Q7	Q8	Q9	Q10	Q11	Q12
Source Video Minutes												
Music	210	466	1,033	2,283	4,458	8,147	13,225	18,333	21,521	24,261	26,679	29,225
Magazines	120	265	596	1,336	2,613	4,782	8,000	11,537	14,825	17,300	19,210	21,230
Studios	500	1,208	2,204	3,566	5,394	7,870	12,725	19,066	23,980	29,376	35,066	40,081
Sports	360	869	2,109	4,462	8,494	14,932	24,859	39,421	52,557	64,974	73,432	82,790
All Others	360	794	1,774	3,706	6,863	11,558	17,973	25,013	28,823	31,688	34,407	37,678
Total Source Video Minutes/Qtr.	1,550	3,602	7,717	15,354	27,821	47,288	76,781	113,370	141,706	167,600	188,794	213,004
Total Encoded Minutes (4 formats)	6,200	14,406	30,866	61,415	111,285	189,152	307,125	453,482	566,824	670,400	755,175	848,015
Total GB Encoded/Qtr.	20.85	48.44	103.79	206.51	374.20	636.02	1,032.71	1,524.83	1,905.95	2,254.22	2,539.28	2,821.45
Cumulative GB Encoded	20.85	69.29	173.08	379.58	753.78	1,389.80	2,422.51	3,947.34	5,853.29	8,107.51	10,646.79	13,468.24
Cumulative Source Minutes Online after Attrition	1,550	4,764	11,290	23,821	45,687	81,553	137,946	216,830	304,329	395,846	485,679	576,163
Cumulative GB Online after Attrition	20.85	64.08	151.84	320.39	614.49	1,096.89	1,855.38	2,916.36	4,093.22	5,324.13	6,532.38	7,751.73
Archival												
Archival Concurrent w/Encoding (AVI/GB)	77.50	257.58	643.40	1,411.09	2,802.16	5,166.56	9,005.62	14,674.14	21,759.44	30,139.44	39,579.13	50,179.02
Attrition of Initial Archival (AVI/GB)	0.00	(7.75)	(25.76)	(64.34)	(141.11)	(280.22)	(516.66)	(900.56)	(1,467.41)	(2,175.94)	(3,013.94)	(3,957.81)
Archival of Online Content moved offline that was not previously archived (encoded format/GB)	0.00	0.47	1.44	3.42	7.21	13.83	24.68	41.75	65.62	92.10	119.79	146.33
Total Cumulative Archival (GB)	77.50	250.29	619.09	1,350.16	2,668.26	4,900.17	8,513.64	13,815.32	20,357.65	28,055.60	36,684.98	46,368.58
GB Hosted by iViewit	5.21	16.02	37.96	80.10	153.62	274.22	463.84	729.09	1,023.30	1,331.03	1,633.09	1,937.38
GB Hosted for Modem												
Music	0.10	0.30	0.74	1.73	3.57	6.85	11.58	17.09	22.53	27.93	33.46	38.93
Magazines	0.06	0.17	0.42	1.01	2.09	4.02	7.01	10.76	15.52	19.92	24.09	28.13
Studios	0.24	0.78	1.57	2.70	4.32	6.62	11.14	17.78	25.11	33.82	43.98	54.16
Sports	0.18	0.56	1.50	3.37	6.80	12.55	21.77	36.76	55.03	74.81	92.09	109.11
All Others	0.18	0.51	1.27	2.80	5.49	9.72	15.74	23.32	30.18	36.49	43.15	49.93
Total GB Hosted for Modem Files	0.76	2.32	5.50	11.61	22.27	39.76	67.25	105.70	148.36	192.98	236.77	280.91
GB Hosted for Broadband Files												
Music	0.60	1.77	4.34	10.18	21.05	40.39	68.31	100.81	132.88	164.74	197.32	228.33
Magazines	0.35	1.01	2.51	5.96	12.34	23.71	41.32	63.44	91.54	117.48	142.08	165.91
Studios	1.44	4.59	9.27	15.91	25.46	39.02	65.73	104.84	148.06	199.47	259.35	321.01
Sports	1.04	3.31	8.87	19.90	40.10	74.04	128.40	216.77	324.51	441.19	543.11	646.99
All Others	1.04	3.02	7.46	16.53	32.40	57.31	92.83	137.54	177.96	215.18	254.47	294.44
Total GB Hosted for Broadband Files	4.46	13.70	32.46	68.48	131.35	234.47	396.60	623.39	874.94	1,138.06	1,396.33	1,656.76
GB Served via Modem	129.40	411.70	1,012.38	2,191.56	4,294.41	7,830.99	13,564.86	22,069.34	31,952.68	42,785.89	53,427.02	64,463.22
GB Served via Broadband	190.79	664.99	1,783.39	4,194.07	8,898.33	17,517.60	32,675.19	57,117.29	88,677.13	127,112.11	169,659.77	218,521.61
Total GB Served	320.19	1,076.69	2,795.77	6,385.62	13,192.74	25,348.60	46,240.05	79,186.62	120,629.81	169,898.00	223,086.79	282,984.83
# of Playbacks per video												
Music	600	630	662	696	721	747	774	802	819	836	853	871
Magazines	300	315	331	348	361	374	386	394	402	411	420	429
Studios	600	630	662	696	721	747	770	786	802	819	836	853
Sports	900	945	993	1,043	1,096	1,151	1,209	1,270	1,334	1,401	1,472	1,546
All Others	450	459	469	479	489	499	509	520	531	542	553	565
Total Playbacks	2,850	2,979	3,117	3,262	3,388	3,518	3,648	3,772	3,888	4,009	4,134	4,264
Encoding	\$31,000	\$72,030	\$154,331	\$307,074	\$556,427	\$945,761	\$1,535,624	\$2,267,409	\$2,834,121	\$3,352,000	\$3,775,874	\$4,240,075
Archival	3,488	11,038	26,756	57,184	110,750	199,321	339,379	539,705	779,379	1,052,608	1,348,843	1,670,788
Hosting	782	2,355	5,469	11,308	21,254	37,181	61,634	94,941	130,589	166,462	200,154	232,735
Serving	9,606	31,655	80,552	180,303	365,057	687,394	1,228,842	2,062,318	3,078,822	4,249,562	5,468,345	6,797,845
Master Licensing	112,500	112,500	225,000	225,000	646,875	759,375	1,068,750	956,250	1,096,875	956,250	1,012,500	928,125
Web Design & Consulting	14,400	16,200	30,000	52,500	77,400	109,500	144,600	149,100	126,000	112,800	106,500	113,100
Total Revenues	\$157,375	\$229,578	\$492,107	\$780,870	\$1,700,364	\$2,629,032	\$4,234,229	\$5,920,623	\$7,919,785	\$9,776,882	\$11,805,715	\$13,869,567
Encoding				Year 1	\$564,435		Year 2	\$5,305,221		Year 3	\$14,202,070	
Archival				98,465	1,189,155			215,011		19,594,573		
Hosting				19,913	302,115			4,343,611		3,993,750		
Serving				675,000	3,431,250			144,824		443,219		
Master Licensing				675,000	3,431,250			144,824		443,219		
Total Revenues by Year				\$1,659,929	\$14,484,248			\$14,484,248		\$43,371,950		

Ivewit Holdings, Inc.
SIGNIFICANT REVENUE ASSUMPTIONS - EXHIBIT 3
Imaging Assumptions
FOR THE THREE YEAR PERIOD

Basic Assumptions	
Image Processing (except Hotels & Resorts - see below)	\$3
Hotel & Resort (per Property)	\$7,800
Monthly Hosting & Serving for Hotel & Resort	\$149
% of Full-Service Clients Hosting Images	100%
Image Hosting/GB/Month (see table below)	\$50
Image Serving/GB Delivered (see table below)	\$30
One-Time Setup Fee (Average)	\$1,500
Image License for Full-Service - Avg. (charged quarterly)	\$500
First Year Image Master License Fee (IML)	\$112,500
Renewal Image Master License Fee (IML)	\$84,375
# of IML clients expressed as a % of Full-Service Clients	see table

Format	File Size (GB)
Small Image Average Size (100KB)	0.0001
Broadband Average Image Size (400KB)	0.0004
Hotel & Resort Package (Small Image 1.2MB)	0.0012
Hotel & Resort Package (Large Image 5.6MB)	0.0056

Web Design & Consulting Assumptions	
% of New Full-Service Clients using this Service	20%
Average Web Design Setup Fee	\$12,000
Quarterly Maintenance Fee	\$1,500

Archiving	Renewal IML Clients
Archival Fee/GB Stored/Month (see table below)	0
% of all encoded content that is taken offline & discarded per quarter	0
% of all encoded content that is taken offline & Archived per quarter	0
% of content Archived Concurrent with Encoding	0
size of an uncompressed image (GB)	0.008

Quarter	Number of Client Accounts												Renewal IML Clients					
	Collectibles/Auctions		Magazines		Retail		Healthcare B2B Education		Modeling & Casting		All Others			Hotels & Resorts		Total IML Clients	New IML Clients by Quarter	Total Client Accounts
1	1	1	1	1	1	1	1	1	1	1	1	1	1	1	1	1	1	8
2	2	2	2	2	2	2	2	2	2	2	2	2	2	2	2	2	2	17
3	3	3	3	3	3	3	3	3	3	3	3	3	3	3	3	3	3	24
4	4	4	4	4	4	4	4	4	4	4	4	4	4	4	4	4	4	34
5	5	5	5	5	5	5	5	5	5	5	5	5	5	5	5	5	5	41
6	6	6	6	6	6	6	6	6	6	6	6	6	6	6	6	6	6	48
7	7	7	7	7	7	7	7	7	7	7	7	7	7	7	7	7	7	55
8	8	8	8	8	8	8	8	8	8	8	8	8	8	8	8	8	8	62
9	9	9	9	9	9	9	9	9	9	9	9	9	9	9	9	9	9	69
10	10	10	10	10	10	10	10	10	10	10	10	10	10	10	10	10	10	76
11	11	11	11	11	11	11	11	11	11	11	11	11	11	11	11	11	11	83
12	12	12	12	12	12	12	12	12	12	12	12	12	12	12	12	12	12	90

Quarter	Number of Images to Process per Client												
	Collectibles/Auctions		Magazines		Retail		Healthcare B2B Education		Modeling & Casting		All Others		Hotels & Resorts
1	6,000	400	300	300	300	300	300	700	400	400	400	n/a	n/a
2	5,000	420	315	315	315	315	315	715	420	420	420	n/a	n/a
3	5,000	441	331	331	331	331	331	772	441	441	441	n/a	n/a
4	5,000	464	348	348	348	348	348	811	464	464	464	n/a	n/a
5	5,000	488	366	366	366	366	366	852	488	488	488	n/a	n/a
6	3,000	503	377	377	377	377	377	878	503	503	503	n/a	n/a
7	3,000	519	389	389	389	389	389	905	519	519	519	n/a	n/a
8	2,000	530	397	397	397	397	397	924	530	530	530	n/a	n/a
9	2,000	541	405	405	405	405	405	943	541	541	541	n/a	n/a
10	2,000	552	414	414	414	414	414	962	552	552	552	n/a	n/a
11	1,000	558	419	419	419	419	419	972	558	558	558	n/a	n/a
12	1,000	564	424	424	424	424	424	982	564	564	564	n/a	n/a

Ivewit Holdings, Inc.
SIGNIFICANT REVENUE ASSUMPTIONS - EXHIBIT 3
Imaging Assumptions
FOR THE THREE YEAR PERIOD

Quarter	Average Number of Hits per Image												
	Collectibles/Auctions		Magazines		Retail		Healthcare B2B Education		Modeling & Casting		All Others		Hotels & Resorts
1	150	150	300	300	300	300	90	120	150	150	150	100	100
2	158	158	315	315	315	315	95	126	158	158	158	105	105
3	166	166	331	331	331	331	100	133	166	166	166	111	111
4	175	175	348	348	348	348	105	140	175	175	175	117	117
5	182	182	361	361	361	361	109	145	182	182	182	122	122
6	189	189	374	374	374	374	113	151	189	189	189	127	127
7	196	196	388	388	388	388	117	157	196	196	196	132	132

Quarter	8	9	10	11	12	1	2	3	4	5	6	7	8	9	10	11	12
Modem Size	3.00%	2.00%	2.00%	1.00%	1.00%	3.00%	2.00%	2.00%	1.00%	1.00%	3.00%	2.00%	2.00%	1.00%	1.00%	3.00%	2.00%
Broadband Size	2.00%	2.00%	2.00%	1.00%	1.00%	2.00%	2.00%	2.00%	1.00%	1.00%	2.00%	2.00%	1.00%	1.00%	2.00%	2.00%	2.00%
Percentage of Total Served	202	207	212	215	218	400	408	417	422	427	400	408	417	422	427	400	408
% of Clients	3.00%	2.00%	2.00%	1.00%	1.00%	3.00%	2.00%	2.00%	1.00%	1.00%	3.00%	2.00%	2.00%	1.00%	1.00%	3.00%	2.00%
# of JML clients expressed as a % of Full-Service Clients	202	207	212	215	218	162	166	170	172	174	162	166	170	172	174	162	166

Broadband vs. Modem Service Ratio		
Quarter	Modem Size Percentage of Total Served	Broadband Size Percentage of Total Served
1	80.00%	20.00%
2	78.50%	21.50%
3	77.00%	23.00%
4	75.50%	24.50%
5	74.00%	26.00%
6	72.50%	27.50%
7	71.00%	29.00%
8	69.50%	30.50%
9	68.00%	32.00%
10	66.50%	33.50%
11	65.00%	35.00%
12	63.50%	36.50%

Quarter	Hosting, Service & Archiving Charges		
	Quarterly Discount	Hosting Charge	Archiving Charge
1		\$50.00	\$15.00
2	2.00%	\$49.00	\$14.70
3	2.00%	\$48.02	\$14.41
4	2.00%	\$47.06	\$14.12
5	2.00%	\$46.12	\$13.84
6	2.00%	\$45.20	\$13.56
7	2.00%	\$44.29	\$13.29
8	2.00%	\$43.41	\$13.02
9	2.00%	\$42.54	\$12.76
10	2.00%	\$41.69	\$12.51
11	2.00%	\$40.85	\$12.26
12	2.00%	\$40.04	\$12.01

Quarter	# of JML clients expressed as a % of Full-Service Clients	
	Quarter	% of Clients
1		10.00%
2		10.00%
3		10.00%
4		10.00%
5		15.00%
6		15.00%
7		15.00%
8		15.00%
9		20.00%
10		20.00%
11		20.00%
12		20.00%

iviewit Holdings, Inc.
SIGNIFICANT REVENUE ASSUMPTIONS - EXHIBIT 4
IMAGING REVENUE PROJECTIONS
FOR THE THREE YEAR PERIOD

Item	Imaging Revenue by Quarter											
	Q1	Q2	Q3	Q4	Q5	Q6	Q7	Q8	Q9	Q10	Q11	Q12
Total Full-Service Clients	6	12	24	40	62	87	112	138	155	171	183	194
Total Hotel & Resort Clients	1	3	6	11	20	30	42	55	66	73	77	81
Total Master License Clients	1	2	4	7	12	18	24	30	36	41	45	48
Total Clients	8	17	34	58	94	135	178	223	257	285	305	323
# of new Source Images/Qtr.												
Collectibles/Auctions	6,000	12,600	26,460	41,676	65,646	90,156	116,085	142,092	161,040	180,708	199,128	217,880
Magazines	400	840	1,764	3,248	5,368	8,048	10,899	13,780	16,230	18,216	20,088	21,432
Retail	300	630	1,324	2,436	4,026	6,032	8,169	10,322	11,745	13,248	14,246	15,264
Healthcare B2B Education	5,000	10,500	22,052	40,523	66,869	100,192	135,450	171,054	194,619	219,072	235,110	251,460
Modeling	700	1,470	3,088	4,866	6,816	8,780	10,860	12,936	15,088	17,316	18,468	19,640
All Others	400	840	1,764	3,248	5,856	8,551	11,418	14,840	16,771	18,768	20,088	21,432
Total # of New Source Images/Qtr.	12,800	26,880	56,452	95,997	154,581	221,759	292,881	365,024	415,493	467,328	507,128	547,108
Cumulative GBs Encoded	6.40	19.84	48.07	96.06	173.36	284.23	430.68	613.19	820.93	1,054.60	1,308.16	1,581.72
Cumulative GBs Online after Attrition	6.40	18.88	45.09	88.85	158.95	258.23	388.04	548.59	728.96	931.46	1,149.97	1,385.49
Archival (cumulative)												
Archival Concurrent w/Encoding (GB)	40.96	126.98	307.62	614.81	1,109.47	1,819.10	2,756.32	3,924.40	5,253.97	6,749.42	8,372.23	10,122.98
Attrition of initial Archival (GB)	0.00	(2.05)	(6.35)	(15.38)	(30.74)	(55.47)	(90.96)	(137.82)	(196.22)	(262.70)	(337.47)	(418.61)
Archival of Online Content moved offline that was not previously archived (encoded format/GB)	0.00	0.38	1.13	2.71	5.33	9.54	15.49	23.28	32.92	43.74	55.89	69.00
Total Cumulative Archival (GB)	40.96	125.31	302.41	602.14	1,084.06	1,773.16	2,680.86	3,809.86	5,090.67	6,530.46	8,090.65	9,773.37
GBs Hosted by iviewit	6.40	18.88	45.09	88.85	158.95	258.23	388.04	548.59	728.96	931.46	1,149.97	1,385.49
GB Hosted for Modem Files												
Collectibles/Auctions	0.60	1.77	4.23	7.72	13.50	21.00	30.76	42.71	56.51	72.04	90.31	110.35
Magazines	0.04	0.12	0.28	0.60	1.10	1.87	2.89	4.14	5.69	7.26	9.11	10.85
Retail	0.03	0.09	0.21	0.45	0.83	1.40	2.16	3.10	4.12	5.28	6.46	7.73
Healthcare B2B Education	0.50	1.48	3.52	7.50	13.75	23.33	35.89	51.41	68.29	87.33	106.63	127.36
Modeling	0.07	0.21	0.49	0.90	1.40	2.04	2.88	3.89	5.29	6.90	8.38	9.95
All Others	0.04	0.12	0.28	0.60	1.20	1.99	3.03	4.46	5.88	7.48	9.11	10.85
Total GB Hosted for Modem Files	1.28	3.78	9.02	17.77	31.79	51.65	77.61	109.72	145.79	186.29	229.99	277.10
GB Hosted for Broadband Files												
Collectibles/Auctions	2.40	7.08	16.91	30.86	54.00	83.99	123.04	170.84	226.03	288.14	361.24	441.41
Magazines	0.16	0.47	1.13	2.41	4.42	7.50	11.55	16.57	22.78	29.05	36.44	43.42
Retail	0.12	0.35	0.85	1.80	3.31	5.62	8.66	12.41	16.48	21.12	25.84	30.92
Healthcare B2B Education	2.00	5.90	14.09	30.01	55.01	93.34	143.57	205.66	273.16	349.32	426.51	509.44
Modeling	0.28	0.83	1.97	3.60	5.61	8.18	11.51	15.55	21.18	27.61	33.50	39.79
All Others	0.16	0.47	1.13	2.41	4.82	7.97	12.10	17.84	23.54	29.93	36.44	43.42
Total GB Hosted for Broadband Files	5.12	15.10	36.07	71.08	127.16	206.59	310.43	438.87	583.16	745.17	919.98	1,108.39
GB Served via Modem	136.32	415.65	1,023.79	2,065.16	3,756.02	6,174.60	9,395.85	13,397.62	17,861.36	22,844.18	28,042.23	33,511.44
GB Served via Broadband	136.32	455.37	1,223.23	2,680.60	5,278.72	9,368.36	15,350.97	23,518.13	33,621.39	46,031.87	60,398.65	77,049.93
Total GB Served	272.64	871.02	2,247.03	4,745.75	9,034.74	15,542.96	24,746.83	36,915.76	51,482.76	68,876.05	88,440.88	110,561.37
# of Times Ea. Image is Displayed												
Collectibles/Auctions	150	158	166	175	182	189	196	202	207	212	215	218
Magazines	300	315	331	348	361	374	388	400	408	417	422	427
Retail	300	315	331	348	361	374	388	400	408	417	422	427
Healthcare B2B Education	90	95	100	105	109	113	117	121	124	127	129	131
Modeling	120	126	133	140	145	151	157	162	166	170	172	174
All Others	150	158	166	175	182	189	196	202	207	212	215	218
Annual License Fee Revenue	\$0	\$3,000	\$6,000	\$12,000	\$20,000	\$31,000	\$43,500	\$56,000	\$69,000	\$77,500	\$85,500	\$91,500
Full-Service Clients Setup Fee Revenue	9,000	9,000	18,000	24,000	33,000	37,500	37,500	39,000	25,500	24,000	18,000	16,500
Hotel & Resort Packages Revenue	7,800	15,600	23,400	39,000	70,200	78,000	93,600	101,400	85,800	54,600	31,200	31,200
Image Processing Revenue	38,400	80,640	169,356	287,991	463,743	665,277	878,643	1,095,072	1,246,479	1,401,984	1,521,384	1,641,324
Master License Revenue	112,500	112,500	225,000	337,500	646,875	759,375	843,750	928,125	1,096,875	1,068,750	956,250	843,750
Hosting Revenue	960	2,775	6,496	12,544	21,991	35,013	51,561	71,436	93,025	116,490	140,942	166,411
Serving Revenue	8,179	25,608	64,741	134,000	250,001	421,488	657,654	961,425	1,313,989	1,722,758	2,167,879	2,655,899
Hosting & Serving Revenue for Hotels & Resorts	447	1,341	2,682	4,917	8,940	13,410	18,774	24,585	29,502	32,631	34,419	36,207
Archival	1,843	5,526	13,069	25,503	44,996	72,126	106,867	148,835	194,893	245,014	297,479	352,163
Web Design & Consulting	16,800	21,300	40,500	59,400	89,700	108,600	123,900	139,800	125,100	121,500	111,600	114,000
Total Revenue	\$195,929	\$277,291	\$569,244	\$936,855	\$1,649,445	\$2,221,789	\$2,855,749	\$3,565,678	\$4,280,163	\$4,865,227	\$5,364,653	\$5,948,953
				Year 1				Year 2				Year 3
Annual License Fee Revenue				\$21,000				\$150,500				\$323,500
Setup Fee Revenue				60,000				147,000				84,000
Hotel & Resort Packages Revenue				85,800				343,200				202,800
Image Processing Revenue				576,387				3,102,735				5,811,171
Master License Revenue				787,500				3,178,125				3,965,625
Hosting Revenue				22,775				180,002				516,868
Serving Revenue				232,529				2,290,568				7,860,524
Hosting & Serving Revenue for Hotels & Resorts				9,387				65,709				132,759
Archival				45,942				372,823				1,089,549
Web Design & Consulting				138,000				462,000				472,200
Total Revenues by Year				\$1,979,320				\$10,292,662				\$20,458,996

iviewit Holdings, Inc.
**PROJECTED TOTAL REVENUE
 FOR THE THREE YEAR PERIOD**

	Total Revenue by Quarter												
	Q1	Q2	Q3	Q4	Q5	Q6	Q7	Q8	Q9	Q10	Q11	Q12	3 Year-Totals
Video													
Encoding	\$31,000	\$72,030	\$154,331	\$307,074	\$556,427	\$945,761	\$1,535,624	\$2,267,409	\$2,834,121	\$3,352,000	\$3,775,874	\$4,240,075	\$20,071,726
Archival	3,488	11,038	26,756	57,184	110,750	199,321	339,379	539,705	779,379	1,052,608	1,348,843	1,670,788	\$6,139,238
Hosting	782	2,355	5,469	11,308	21,254	37,181	61,634	94,941	130,589	166,462	200,154	232,735	\$964,863
Servicing	9,606	31,655	80,552	180,303	365,057	687,394	1,228,842	2,062,318	3,078,822	4,249,562	5,468,345	6,797,845	\$24,240,299
Master Licensing	112,500	112,500	225,000	225,000	646,875	759,375	1,068,750	956,250	1,096,875	956,250	1,012,500	928,125	\$8,100,000
Web Design & Consulting	14,400	16,200	30,000	52,500	77,400	109,500	144,600	149,100	126,000	112,800	106,500	113,100	\$1,052,100
Video Total by Quarter	\$157,375	\$229,578	\$492,107	\$780,870	\$1,700,364	\$2,629,032	\$4,234,229	\$5,920,623	\$7,919,785	\$9,776,882	\$11,805,715	\$13,869,567	\$59,516,126
Video Total by Year				\$1,659,929				\$14,484,248				\$43,371,950	
Imaging													
Annual License Fee Revenue	\$0	\$3,000	\$6,000	\$12,000	\$20,000	\$31,000	\$43,500	\$56,000	\$69,000	\$77,500	\$85,500	\$91,500	\$495,000
Setup Fee Revenue	9,000	9,000	18,000	24,000	33,000	37,500	37,500	39,000	25,500	24,000	18,000	16,500	\$291,000
Hotel & Resort Packages													
Revenue	7,800	15,600	23,400	39,000	70,200	78,000	93,600	101,400	85,800	54,600	31,200	31,200	\$631,800
Image Processing Revenue	38,400	80,640	169,356	287,991	463,743	665,277	878,643	1,095,072	1,246,479	1,401,984	1,521,384	1,641,324	\$9,490,293
Master License Revenue	112,500	112,500	225,000	337,500	646,875	759,375	843,750	928,125	1,096,875	1,068,750	956,250	843,750	\$7,931,250
Hosting Revenue	960	2,775	6,496	12,544	21,991	35,013	51,561	71,436	93,025	116,490	140,942	166,411	\$719,645
Servicing Revenue	8,179	25,608	64,741	134,000	250,001	421,488	657,654	961,425	1,313,989	1,722,758	2,167,879	2,655,899	\$10,383,621
Hosting & Servicing Revenue for Hotels & Resorts	447	1,341	2,682	4,917	8,940	13,410	18,774	24,585	29,502	32,631	34,419	36,207	\$207,855
Archival	1,843	5,526	13,069	25,503	44,996	72,126	106,867	148,835	194,893	245,014	297,479	352,163	\$1,508,314
Web Design & Consulting	16,800	21,300	40,500	59,400	89,700	108,600	123,900	139,800	125,100	121,500	111,600	114,000	\$1,072,200
Imaging Total by Quarter	\$195,929	\$277,291	\$569,244	\$936,855	\$1,649,445	\$2,221,789	\$2,855,749	\$3,565,678	\$4,280,163	\$4,865,227	\$5,364,653	\$5,948,953	\$32,730,977
Imaging Total by Year				\$1,979,320				\$10,292,662				\$20,458,960	
Grand Total by Quarter	\$353,304	\$506,868	\$1,061,351	\$1,717,725	\$3,349,809	\$4,850,821	\$7,089,977	\$9,486,501	\$12,199,948	\$14,642,109	\$17,170,368	\$19,818,520	\$92,247,104
Grand Total by Year				\$3,639,248				\$24,776,909				\$63,830,946	

Iviewit Holdings, Inc.
**PROJECTED COST OF GOODS SOLD
 FOR THE THREE YEAR PERIOD**

Number of Employees by Quarter

Function	Assumption	Allocation	Q1	Q2	Q3	Q4	Q5	Q6	Q7	Q8	Q9	Q10	Q11	Q12
VP Operations	\$150,000		1	1	1	1	1	1	1	1	1	1	1	1
Production Manager	75,000		1	1	1	1	2	2	2	2	2	2	2	2
Production Supervisor	65,000		0	1	1	1	2	3	3	3	3	3	3	3
Quality Manager	65,000		1	1	1	1	1	1	1	1	1	1	1	1
Senior Production Tech	45,000		1	1	1	2	3	4	7	10	11	12	14	16
Production Tech	32,000		0	1	2	3	4	8	12	18	20	24	27	30
Scheduler	32,000		0	1	1	1	1	1	1	1	1	1	1	1
Programmer Java	95,000		1	1	1	1	1	1	1	1	1	1	1	1
Process Applications	84,000		0	1	1	1	1	1	1	1	1	1	1	1
Data Manager	75,000		1	2	3	3	3	3	3	3	3	3	3	3
Network Manager	72,000		1	1	2	2	2	2	2	2	2	2	2	2
Hardware Tech	45,000		0	1	1	1	1	1	1	1	1	1	1	1
Image Operator	45,000		1	2	4	7	10	14	19	23	23	25	27	29
Total Production			8	15	20	25	32	42	54	67	70	77	84	91

Projected Cost of Goods Sold for the Three Year Period

Function	Assumption	Allocation	Q1	Q2	Q3	Q4	Q5	Q6	Q7	Q8	Q9	Q10	Q11	Q12	Totals
VP Operations		70%	\$26,250	\$26,250	\$26,250	\$26,250	\$27,563	\$27,563	\$27,563	\$27,563	\$28,941	\$28,941	\$28,941	\$28,941	\$331,013
Production Manager	18,750		18,750	18,750	18,750	18,750	38,438	38,438	38,438	38,438	40,359	40,359	40,359	40,359	390,188
Production Supervisor	0		16,250	16,250	16,250	16,250	32,500	49,563	49,563	49,563	52,041	52,041	52,041	52,041	436,434
Quality Manager	16,250		16,250	16,250	16,250	17,063	17,063	17,063	17,063	17,063	17,916	17,916	17,916	17,916	204,913
Senior Production Tech	11,250		11,250	11,250	11,250	22,500	34,313	45,563	79,313	113,625	126,028	137,841	162,028	186,806	941,766
Production Tech	0		8,000	8,000	8,000	24,000	32,000	64,400	96,800	145,200	161,600	195,620	221,640	248,460	1,213,720
Scheduler	0		8,000	8,000	8,000	8,000	8,400	8,400	8,400	8,400	8,400	8,820	8,820	8,820	92,060
Programmer Java	11,875		11,875	11,875	11,875	12,469	12,469	12,469	12,469	12,469	13,092	13,092	13,092	13,092	149,744
Research Tools	21,000		21,000	21,000	21,000	22,050	22,050	22,050	22,050	22,050	23,153	23,153	23,153	241,658	
Data Manager	28,125		28,125	28,125	28,125	42,188	42,891	43,594	44,297	44,297	45,035	45,773	46,512	46,512	485,473
Network Manager	9,000		9,000	9,000	18,000	18,000	18,450	18,450	18,450	18,900	19,373	19,845	19,845	207,135	207,135
Hardware Tech	0		11,250	11,250	11,250	11,250	11,813	11,813	11,813	11,813	12,403	12,403	12,403	12,403	129,459
Image Operator	11,250		22,500	22,500	45,000	78,750	113,063	158,625	216,000	262,688	264,966	290,306	316,800	343,322	2,123,269
Travel & Entertainment	3,000		6,000	6,000	6,000	9,000	12,000	12,000	12,000	12,000	12,000	12,000	12,000	12,000	117,000
Travel & Training	1,500		3,000	3,000	4,500	7,500	9,000	12,000	12,000	15,000	16,500	18,000	19,500	21,000	133,500
Employee Benefits	25%		29,672	52,125	65,516	78,766	102,249	129,497	160,666	193,016	202,487	221,409	240,887	260,417	1,736,707
Allocated Costs for: Occupancy, Utilities, Telephone & Insurance			13,950	39,186	38,064	56,038	55,677	70,511	71,355	72,277	73,389	74,493	75,702	77,025	717,666
Capital Equipment	16,800		0	16,800	33,600	84,000	84,000	151,200	201,600	218,400	50,400	117,600	117,600	117,600	1,192,800
Contract Work	1,500		36,000	36,000	47,000	61,500	78,600	96,500	113,571	125,250	126,333	124,200	120,000	116,500	1,081,455
Photo Contract Services	3,500		3,500	7,000	10,500	17,500	31,500	35,000	42,000	45,500	38,500	24,500	14,000	14,000	283,500
Total			206,309	368,611	467,242	627,866	777,523	1,021,696	1,255,858	1,453,509	1,329,556	1,477,839	1,563,238	1,660,211	12,209,458
less: Capital Equipment			0	(16,800)	(33,600)	(84,000)	(84,000)	(151,200)	(201,600)	(218,400)	(50,400)	(117,600)	(117,600)	(117,600)	(1,192,800)
add: Depreciation			11,200	11,200	11,200	11,200	65,800	65,800	65,800	65,800	99,400	99,400	99,400	99,400	705,600
Adjusted Total			217,509	363,011	444,842	555,066	759,323	936,296	1,120,058	1,300,909	1,378,556	1,459,639	1,545,038	1,642,011	11,722,258
Production Requirements and Expense			121,227	95,353	93,049	167,395	436,097	547,897	702,483	814,381	1,574,400	1,689,433	1,874,186	2,029,171	10,145,074
Totals for Production costs			\$338,737	\$458,364	\$537,891	\$722,461	\$1,195,421	\$1,484,193	\$1,822,541	\$2,115,290	\$2,952,956	\$3,149,072	\$3,419,223	\$3,671,182	\$21,867,332

Ivewit Holdings, Inc.
**PROJECTED COST OF GOODS SOLD
 FOR THE THREE YEAR PERIOD**

Production Requirements & Expense

Function	Assumption	Allocation	Q1	Q2	Q3	Q4	Q5	Q6	Q7	Q8	Q9	Q10	Q11	Q12
Total			121,227	95,353	93,049	167,395	436,097	547,897	702,483	814,381	1,574,400	1,689,433	1,874,186	2,029,171
Totals for Production costs			\$338,737	\$458,364	\$537,891	\$722,461	\$1,195,421	\$1,484,193	\$1,822,541	\$2,115,290	\$2,952,956	\$3,149,072	\$3,419,223	\$3,671,182

GBs Hosted for Video	5.21	16.02	37.96	80.10	153.62	274.22	463.84	729.09	1,023.30	1,331.03	1,633.09	1,937.68
GBs Hosted for Imaging	6.40	18.88	45.09	88.85	158.95	258.23	388.04	548.59	728.96	931.46	1,149.97	1,385.49
Total GBs Hosted	11.61	34.90	83.05	168.95	312.57	532.45	851.88	1,277.68	1,752.26	2,262.49	2,783.07	3,323.17
GBs Archived for Video	77.50	250.29	619.09	1,350.16	2,668.26	4,900.17	8,513.64	13,815.32	20,357.65	28,055.60	36,684.98	46,368.38
GBs Archived for Imaging	40.96	125.31	302.41	602.14	1,084.06	1,773.16	2,680.86	3,809.86	5,090.67	6,530.46	8,090.65	9,773.37
Total GBs Archived	118.46	375.61	921.49	1,952.30	3,752.32	6,673.33	11,194.50	17,625.19	25,448.32	34,586.06	44,775.63	56,141.75
GBs Served for Video	320.19	1,076.69	2,795.77	6,385.62	13,192.74	25,348.60	46,240.05	79,186.62	120,629.81	169,898.00	223,086.79	283,984.83
GBs Served for Imaging	272.64	871.02	2,247.03	4,745.75	9,034.74	15,542.96	24,746.83	36,915.76	51,482.76	68,876.05	88,440.88	110,561.37
Total GBs Served	592.83	1,947.71	5,042.80	11,131.38	22,227.48	40,891.56	70,986.88	116,102.38	172,112.57	238,774.05	311,527.67	393,546.20
Storage/Hosting Cost (\$25,000/100GB)	\$25,000	\$0	\$0	\$25,000	\$50,000	\$50,000	\$75,000	\$100,000	\$125,000	\$125,000	\$150,000	\$150,000
Caching Server Expense	100,000	0	0	0	0	0	0	0	0	0	0	0
Storage/Archiving Cost (\$125,000/Terabyte)	125,000	14,808	32,143	68,236	128,851	225,002	365,127	565,146	803,836	1,142,218	1,273,696	1,420,765
Server Expense	5,000	0	5,000	10,000	15,000	20,000	30,000	40,000	50,000	50,000	50,000	55,000
Other Hardware	30,000	0	0	0	0	0	0	0	0	0	0	30,000
Bandwidth Costs	20,000	60,000	57,600	106,168	152,882	244,612	375,724	495,955	692,534	831,041	997,249	1,148,831
Associated w/Server	11,737	23,474	0	23,474	26,878	46,948	70,422	62,089	119,248	95,774	114,318	117,722
Real/Server License Fees	750	3,000	4,500	3,750	5,250	7,500	9,000	9,750	2,250	5,250	5,250	5,250
Furniture & Fixtures												
Total Production Expense	261,282	94,243	132,282	297,243	475,012	864,187	1,130,292	1,641,630	2,096,923	2,379,282	2,695,513	3,027,568
less: Fixed Assets	(177,808)	(36,643)	(76,986)	(167,601)	(295,252)	(572,627)	(684,146)	(1,083,586)	(1,285,141)	(1,452,468)	(1,583,946)	(1,761,015)
add: Depreciation	37,753	37,753	37,753	37,753	256,337	256,337	256,337	256,337	762,618	762,618	762,618	762,618
Adjusted Total	\$121,227	\$95,353	\$93,049	\$167,395	\$436,097	\$547,897	\$702,483	\$814,381	\$1,574,400	\$1,689,433	\$1,874,186	\$2,029,171
Internal Network Support	\$11,250	\$11,250	\$11,250	\$11,250	\$11,813	\$11,813	\$11,813	\$11,813	\$12,403	\$12,403	\$12,403	\$12,403
Data Manager	4,688	9,375	14,063	14,063	14,297	14,531	14,766	14,766	15,012	15,258	15,504	15,504
Network Manager	9,000	9,000	18,000	18,000	18,450	18,450	18,900	18,900	19,373	19,845	19,845	19,845
Programmer Java	11,875	11,875	11,875	11,875	12,469	12,469	12,469	12,469	13,092	13,092	13,092	13,092
Internal Routers,												
Servers, Workstations	65,000	49,000	5,000	49,000	30,000	69,000	15,000	10,000	70,000	10,000	10,000	5,000
Internal Bandwidth												
(2 TT Lines/Location)	4,800	9,600	9,600	14,400	14,400	19,200	19,200	19,200	19,200	19,200	19,200	19,200
Total	106,613	100,100	69,788	118,588	101,428	145,463	92,147	87,147	149,080	89,326	90,044	85,044
less: Fixed Assets	(65,000)	(49,000)	(5,000)	(49,000)	(30,000)	(69,000)	(15,000)	(10,000)	(70,000)	(10,000)	(10,000)	(5,000)
Total	\$41,613	\$51,100	\$64,788	\$69,588	\$71,428	\$76,463	\$77,147	\$77,147	\$79,080	\$79,326	\$80,044	\$80,044
Marketing Allocation	\$27,048	\$33,215	\$42,112	\$45,232	\$46,428	\$49,701	\$50,145	\$50,145	\$51,402	\$51,562	\$52,029	\$52,029
Corporate Allocation	10,403	12,775	16,197	17,857	19,116	19,287	19,287	19,287	19,770	19,831	20,011	20,011
R&D Allocation	4,161	5,110	6,479	6,959	7,143	7,646	7,715	7,715	7,908	7,933	8,004	8,004
Total	\$41,613	\$51,100	\$64,788	\$69,588	\$71,428	\$76,463	\$77,147	\$77,147	\$79,080	\$79,326	\$80,044	\$80,044

Ivewit Holdings, Inc.
 PROJECTED CORPORATE AND RESEARCH AND DEVELOPMENT EXPENSE
 FOR THE THREE YEAR PERIOD

Corporate Cost Structure

Function	Number of Employees by Quarter												Totals	
	Q1	Q2	Q3	Q4	Q5	Q6	Q7	Q8	Q9	Q10	Q11	Q12		
Chief Executive Officer	1	1	1	1	1	1	1	1	1	1	1	1	1	\$866,938
President	1	1	1	1	1	1	1	1	1	1	1	1	1	551,688
Founder & Sr. VP	1	1	1	1	1	1	1	1	1	1	1	1	1	709,313
Office Manager	1	1	1	1	1	1	1	1	1	1	1	1	1	157,625
Secretarial Support	2	2	2	3	3	3	3	3	3	3	3	3	3	302,072
Chief Financial Officer	1	1	1	1	1	1	1	1	1	1	1	1	1	394,063
Controller	1	1	1	1	1	1	1	1	1	1	1	1	1	252,200
Accountant	1	1	1	1	1	1	1	1	1	1	1	1	1	208,169
In House Counsel	1	1	1	1	1	1	1	1	1	1	1	1	1	394,063
Legal Support	1	1	1	1	1	1	1	1	1	1	1	1	1	304,663
CTO	1	1	1	1	1	1	1	1	1	1	1	1	1	208,169
Assistant	1	1	1	1	1	1	1	1	1	1	1	1	1	394,063
Professional Development Staff	2	2	2	3	3	3	3	3	3	3	3	3	3	162,794
Software Developers	1	1	1	1	1	1	1	1	1	1	1	1	1	648,000
Technician	1	1	1	1	1	1	1	1	1	1	1	1	1	216,000
Total Corporate & R&D	13	15	15	19	22	29	29	29	38	38	38	38	38	\$1,148

Note: Cost of Living Adj 5%
 EE Benefits as % of Salary 25%

Function	Corporate Costs												Totals	
	Q1	Q2	Q3	Q4	Q5	Q6	Q7	Q8	Q9	Q10	Q11	Q12		
Chief Executive Officer	\$68,750	\$68,750	\$68,750	\$68,750	\$72,188	\$72,188	\$72,188	\$72,188	\$75,797	\$75,797	\$75,797	\$75,797	\$75,797	\$866,938
President	43,750	43,750	43,750	43,750	45,938	45,938	45,938	45,938	48,234	48,234	48,234	48,234	48,234	551,688
Founder & Sr. VP	56,250	56,250	56,250	56,250	59,063	59,063	59,063	59,063	62,016	62,016	62,016	62,016	62,016	709,313
Office Manager	12,500	12,500	12,500	12,500	13,125	13,125	13,125	13,125	13,781	13,781	13,781	13,781	13,781	157,625
Secretarial Support	17,500	17,500	17,500	26,250	27,125	27,125	27,125	27,563	28,481	28,481	28,481	28,481	28,941	302,072
Chief Financial Officer	31,250	31,250	31,250	31,250	32,813	32,813	32,813	32,813	34,453	34,453	34,453	34,453	34,453	394,063
Controller	20,000	20,000	20,000	20,000	21,000	21,000	21,000	21,000	22,050	22,050	22,050	22,050	22,050	252,200
Accountant	9,500	9,500	9,500	9,500	19,475	19,475	19,475	19,475	20,449	20,449	20,449	20,449	20,449	208,169
In House Counsel	31,250	31,250	31,250	31,250	32,813	32,813	32,813	32,813	34,453	34,453	34,453	34,453	34,453	394,063
Legal Support	0	0	0	17,500	17,500	17,500	17,500	18,375	18,375	18,375	18,375	18,375	18,375	162,794
Consultants	54,000	54,000	54,000	54,000	54,000	54,000	54,000	54,000	54,000	54,000	54,000	54,000	54,000	648,000
Outside Counsel	18,000	18,000	18,000	18,000	18,000	18,000	18,000	18,000	18,000	18,000	18,000	18,000	18,000	216,000
Allocated Costs for Occupancy, Utilities, Telephone & Insurance	19,530	22,496	22,548	24,738	24,977	26,856	27,203	27,582	28,079	28,533	29,030	29,575	311,148	
Bad Debt Expense	0	9,186	18,125	34,691	59,520	111,143	173,019	252,251	345,904	450,007	551,494	651,419	2,656,758	
Furniture & Fixtures	20,000	0	0	15,000	0	0	0	0	0	0	0	0	35,000	
Audit Fees	0	0	0	65,000	0	0	0	100,000	0	0	0	0	300,000	
Investment Banking Fees	1,200,000	0	0	0	0	0	0	0	0	0	0	0	1,200,000	
Travel & Entertainment	54,000	54,000	54,000	54,000	54,000	54,000	54,000	54,000	54,000	54,000	54,000	54,000	648,000	
Recruiting Retainer	30,000	30,000	30,000	30,000	30,000	30,000	30,000	30,000	30,000	30,000	30,000	30,000	360,000	
Network Support	10,403	12,775	16,197	17,397	17,857	19,116	19,287	19,287	19,770	19,831	20,011	20,011	211,941	
Bonus Pool accrued on revenue	14,132	20,275	42,454	68,709	133,992	194,033	283,599	379,452	487,998	585,684	686,815	792,741	3,689,884	
Employee Benefits	74,988	75,281	76,137	85,074	88,824	88,838	88,881	89,328	93,265	93,280	93,325	93,794	1,041,016	
Total	\$1,785,804	\$3,866,763	\$6,222,211	\$7,951,110	\$8,222,208	\$9,937,024	\$11,089,026	\$11,366,724	\$11,489,105	\$11,691,425	\$11,894,765	\$12,238,507	\$15,316,670	

12 month Total \$3,787,887 \$4,214,982

Function	R&D Cost												Totals	
	Q1	Q2	Q3	Q4	Q5	Q6	Q7	Q8	Q9	Q10	Q11	Q12		
CTO	\$31,250	\$31,250	\$31,250	\$31,250	\$32,813	\$32,813	\$32,813	\$32,813	\$34,453	\$34,453	\$34,453	\$34,453	\$34,453	\$394,063
Assistant	9,250	9,250	9,250	9,250	9,713	9,713	9,713	9,713	10,198	10,198	10,198	10,198	10,198	116,643
Professional Development Staff	0	35,000	35,000	52,500	52,500	106,750	107,625	106,750	164,588	164,588	164,588	164,588	165,506	1,150,931
Software Developers	0	0	0	0	52,500	105,000	105,000	105,000	160,125	160,125	160,125	162,750	162,750	1,015,875
Technician	8,750	8,750	8,750	8,750	9,188	17,938	17,938	17,938	44,647	44,647	45,084	45,084	45,084	277,900

CONFIDENTIAL

	13,233	22,100	22,442	26,817	40,604	69,485	69,502	69,721	103,884	105,771	105,789	106,019	755,367
Employee Benefits													
Allocated Costs for Occupancy, Utilities, Telephone & Insurance													
Network Support	5,580	5,630	5,685	5,745	5,832	5,903	5,982	6,068	6,184	6,286	6,399	6,522	71,816
Furniture & Fixtures	4,161	5,110	6,479	6,959	7,143	7,646	7,715	7,715	7,908	7,933	8,004	8,004	84,777
Capital Expenditures	10,000	10,000	0	5,000	15,000	0	0	0	45,000	0	0	0	120,000
Expense Development Materials	25,000	25,000	25,000	25,000	50,000	50,000	50,000	50,000	100,000	100,000	100,000	100,000	700,000
Travel & Entertainment	6,250	6,250	6,250	6,250	12,500	12,500	12,500	12,500	25,000	25,000	25,000	25,000	175,000
Intellectual Property Processing	3,000	6,000	6,000	7,500	7,500	12,000	12,000	12,000	16,500	16,500	16,500	16,500	132,000
Travel and Conferences	60,000	60,000	60,000	60,000	60,000	60,000	60,000	60,000	60,000	60,000	60,000	60,000	720,000
Subcontract	0	2,000	2,000	4,000	6,000	6,000	12,000	12,000	18,000	18,000	18,000	18,000	120,000
	8,222	8,987	6,862	7,314	10,075	15,932	13,433	12,607	19,084	16,983	16,199	15,546	151,245
Sub-Total	184,696	235,327	224,968	256,335	371,366	552,679	515,344	515,698	811,108	773,547	772,965	773,584	5,987,616
less: Furniture & Fixtures	(10,000)	(10,000)	0	(5,000)	(15,000)	(35,000)	0	0	(45,000)	0	0	0	(120,000)
less: Capital Expenditures	(25,000)	(25,000)	(25,000)	(25,000)	(50,000)	(50,000)	(50,000)	(50,000)	(100,000)	(100,000)	(100,000)	(100,000)	(700,000)
Total	\$149,696	\$200,327	\$199,968	\$226,335	\$306,366	\$467,679	\$465,344	\$465,698	\$666,108	\$673,547	\$672,965	\$673,584	\$5,167,616
12 month Total				\$776,326			\$1,705,086						\$2,686,204

Occupancy, Utilities & Telephone (Allocated)

	Quarterly Increase	Boea Facility	LA Facility	NY Facility	II, Facility	Total
Occupancy	0.00%	\$45,000	\$45,000	\$45,000	\$45,000	\$180,000
Property & Casualty Insurance		\$900	\$900	\$900	\$900	\$3,600
Directors & Officers Insurance	2.50%	\$3,300	\$3,300	\$3,300	\$3,300	\$13,200
Utilities	10.00%	2,100	2,153	2,206	2,318	8,777
Telephone		4,500	4,950	5,445	5,990	20,885
Total		\$55,800	\$58,303	\$58,551	\$63,508	\$236,162
Occupancy	0.00%	\$45,000	\$45,000	\$45,000	\$45,000	\$180,000
Property & Casualty Insurance		\$900	\$945	\$945	\$945	\$3,735
Utilities	2.50%	2,100	2,153	2,206	2,318	8,777
Telephone	10.00%	4,500	4,950	5,445	5,990	20,885
Total		\$55,800	\$58,303	\$58,551	\$63,508	\$236,162
Occupancy	0.00%	\$31,500	\$31,500	\$31,500	\$31,500	\$126,000
Property & Casualty Insurance		\$630	\$662	\$662	\$662	\$2,616
Utilities	2.50%	1,470	1,544	1,583	1,663	6,260
Telephone	10.00%	3,150	3,465	3,812	4,193	15,620
Total		\$36,750	\$37,133	\$37,517	\$38,396	\$150,156
Occupancy	0.00%	\$27,000	\$27,000	\$27,000	\$27,000	\$108,000
Property & Casualty Insurance		\$567	\$567	\$567	\$567	\$2,268
Utilities	2.50%	1,260	1,292	1,324	1,357	5,233
Telephone	10.00%	2,700	2,970	3,267	3,594	13,530
Total		\$33,527	\$33,829	\$34,151	\$34,518	\$136,955
Total of Allocable Expenses		\$112,103	\$119,854	\$120,662	\$125,522	\$478,142

Allocated To:

Corporate	\$19,530	\$22,496	\$22,548	\$24,738	\$24,977	\$26,856	\$27,203	\$27,582	\$28,079	\$28,533	\$29,030	\$29,575	\$311,148
R&D	5,580	5,630	5,685	5,832	5,903	6,068	6,184	6,399	6,608	6,816	7,025	7,234	74,993
Production	13,950	39,186	38,064	56,038	55,677	70,511	71,355	72,277	73,389	74,493	75,702	77,025	717,666
Marketing	16,740	44,791	43,557	63,160	63,541	79,658	80,612	81,656	82,918	84,167	85,535	87,032	813,366
	\$55,800	\$112,103	\$109,854	\$150,062	\$149,646	\$182,929	\$185,151	\$187,582	\$190,570	\$193,480	\$196,666	\$199,155	\$1,913,997

Ivewit Holdings, Inc.
PROJECTED MARKETING & SALES EXPENSE
FOR THE THREE YEAR PERIOD

Function	Number of Employees by Quarter											
	Q1	Q2	Q3	Q4	Q5	Q6	Q7	Q8	Q9	Q10	Q11	Q12
VP of Marketing	1	1	1	1	1	1	1	1	1	1	1	1
VP of Sales	1	1	1	1	1	1	1	1	1	1	1	1
Sales Directors	4	6	7	8	10	12	14	16	18	20	21	22
Sales Associates	1	2	2	2	3	3	4	4	5	5	6	6
Media Executive	1	1	1	1	1	1	1	1	1	1	1	1
Total Mktg. & Sales	8	11	12	13	16	18	21	23	26	28	30	31

Function	Base Assumption	Marketing & Sales Expenses by Quarter												Total			
		Q1	Q2	Q3	Q4	Q5	Q6	Q7	Q8	Q9	Q10	Q11	Q12				
VP of Marketing	\$150,000	\$37,500	\$37,500	\$37,500	\$37,500	\$39,375	\$39,375	\$39,375	\$39,375	\$41,344	\$41,344	\$41,344	\$41,344	\$41,344	\$41,344	\$41,344	
VP of Sales	125,000	31,250	31,250	31,250	31,250	32,813	32,813	32,813	32,813	34,453	34,453	34,453	34,453	34,453	34,453	34,453	
Sales Directors	75,000	112,500	131,250	150,000	191,250	230,625	269,063	269,063	269,063	350,813	350,813	350,813	350,813	350,813	350,813	350,813	
Sales Associates	6,250	12,500	12,500	12,500	12,500	12,500	12,500	12,500	12,500	12,516	12,516	12,516	12,516	12,516	12,516	12,516	
Media Executive	16,250	16,250	16,250	16,250	17,063	17,063	17,063	17,063	17,063	17,916	17,916	17,916	17,916	17,916	17,916	17,916	
Employee Benefits	47,545	59,244	66,155	70,843	84,158	94,118	105,401	105,401	105,401	128,991	128,991	128,991	128,991	128,991	128,991	128,991	
Travel & Entertainment	90,000	126,000	144,000	162,000	198,000	234,000	270,000	270,000	270,000	342,000	342,000	342,000	342,000	342,000	342,000	342,000	
Sales Commissions	52,996	74,652	156,484	252,455	493,543	710,952	1,037,544	1,037,544	1,037,544	1,385,108	1,385,108	1,385,108	1,385,108	1,385,108	1,385,108	1,385,108	
Meetings & Recognition	2%	7,066	10,137	21,227	34,354	66,996	97,016	141,800	141,800	189,726	189,726	189,726	189,726	189,726	189,726	189,726	
Furniture & Fixtures	5,000	25,000	5,000	5,000	5,000	5,000	5,000	5,000	5,000	15,000	15,000	15,000	15,000	15,000	15,000	15,000	
Brand Strategy Development		100,000	100,000	0	0	0	0	0	0	0	0	0	0	0	0	0	
Collateral Materials		200,000	150,000	150,000	150,000	75,000	75,000	75,000	75,000	75,000	75,000	75,000	75,000	75,000	75,000	75,000	
Public Relations	10,000	30,000	30,000	30,000	30,000	30,000	30,000	30,000	30,000	30,000	30,000	30,000	30,000	30,000	30,000	30,000	
Advertising & Trade Shows		597,500	597,500	597,500	597,500	397,500	397,500	397,500	397,500	397,500	397,500	397,500	397,500	397,500	397,500	397,500	
Market Research	10,000	30,000	30,000	30,000	30,000	30,000	30,000	30,000	30,000	30,000	30,000	30,000	30,000	30,000	30,000	30,000	
Allocated Costs		16,740	44,791	43,557	63,541	63,160	79,658	80,612	82,918	84,167	85,535	85,535	85,535	85,535	85,535	85,535	
Network Support		27,048	33,215	42,112	45,232	46,428	49,701	50,145	50,145	51,402	51,402	51,402	51,402	51,402	51,402	51,402	
Total		\$1,390,144	\$1,480,539	\$1,514,785	\$1,688,425	\$1,799,348	\$2,147,194	\$2,616,939	\$3,092,520	\$3,651,956	\$4,136,047	\$4,605,795	\$5,082,501	\$5,570,000	\$6,059,297	\$6,548,552	\$7,037,875

iviewit Holdings, Inc.
PROJECTED FIXED ASSET AND DEPRECIATION SCHEDULE
FOR THE THREE YEAR PERIOD

TYPE OF EQUIPMENT	YEAR	LIFE	TOTAL COST	DEPRECIATION EXPENSE		
				YEAR 1	YEAR 2	YEAR 3
PRODUCTION LABOR CATEGORY						
CAPITAL EQUIPMENT	1	3	\$134,400	\$44,800	\$44,800	\$44,800
CAPITAL EQUIPMENT	2	3	655,200		218,400	218,400
CAPITAL EQUIPMENT	3	3	403,200			134,400
TO PRODUCTION LABOR			<u>\$1,192,800</u>	<u>\$44,800</u>	<u>\$263,200</u>	<u>\$397,600</u>
PRODUCTION REQUIREMENTS AND EXPENSE CATEGORY						
STORAGE/HOSTING	1	3	\$50,000	\$16,667	\$16,667	\$16,667
STORAGE/HOSTING	2	3	275,000		91,667	91,667
STORAGE/HOSTING	3	3	525,000			175,000
CACHING SERVER	1	3	100,000	33,333	33,333	33,333
CACHING SERVER	2	3	200,000		66,667	66,667
CACHING SERVER	3	3	400,000			133,333
STORAGE/ARCHIVING	1	3	244,038	81,346	81,346	81,346
STORAGE/ARCHIVING	2	3	1,959,111		653,037	653,037
STORAGE/ARCHIVING	3	3	4,814,570			1,604,857
SERVERS	1	3	20,000	6,667	6,667	6,667
SERVERS	2	3	110,000		36,667	36,667
SERVERS	3	3	205,000			68,333
OTHER HARDWARE	1	3	30,000	10,000	10,000	10,000
OTHER HARDWARE	2	3	60,000		20,000	20,000
OTHER HARDWARE	3	3	120,000			40,000
FURNITURE & FIXTURES	1	5	15,000	3,000	3,000	3,000
FURNITURE & FIXTURES	2	5	31,500		6,300	6,300
FURNITURE & FIXTURES	3	5	18,000			3,600
TO PRODUCTION REQUIREMENTS			<u>\$9,177,218</u>	<u>\$151,013</u>	<u>\$1,025,349</u>	<u>\$3,050,473</u>
SUB-TOTAL TO COST OF GOODS SOLD				<u>\$195,813</u>	<u>\$1,288,549</u>	<u>\$3,448,073</u>
NETWORK SUPPORT CATEGORY						
INTERNAL ROUTERS, SERVERS, WORKSTATIONS	1	3	\$168,000	\$56,000	\$56,000	\$56,000
INTERNAL ROUTERS, SERVERS, WORKSTATIONS	2	3	124,000		41,333	41,333
INTERNAL ROUTERS, SERVERS, WORKSTATIONS	3	3	95,000			31,667
			<u>\$387,000</u>	<u>\$56,000</u>	<u>\$97,333</u>	<u>\$129,000</u>
CORPORATE COST						
FURNITURE & FIXTURES	1	5	\$35,000	\$7,000	\$7,000	\$7,000
FURNITURE & FIXTURES	2	5	0		0	0
FURNITURE & FIXTURES	3	5	0			0
			<u>\$35,000</u>	<u>\$7,000</u>	<u>\$7,000</u>	<u>\$7,000</u>
R & D COST						
FURNITURE & FIXTURES	1	5	\$25,000	\$5,000	\$5,000	\$5,000
FURNITURE & FIXTURES	2	5	50,000		10,000	10,000
FURNITURE & FIXTURES	3	5	45,000			9,000
CAPITAL EQUIPMENT	1	3	100,000	33,333	33,333	33,333
CAPITAL EQUIPMENT	2	3	200,000		66,667	66,667
CAPITAL EQUIPMENT	3	3	400,000			133,333
			<u>\$820,000</u>	<u>\$38,333</u>	<u>\$115,000</u>	<u>\$257,333</u>
SUB-TOTAL TO DEPRECIATION EXPENSE				<u>\$101,333</u>	<u>\$219,333</u>	<u>\$393,333</u>
TOTAL				<u>\$11,612,018</u>	<u>\$297,146</u>	<u>\$1,507,883</u>
TOTAL ACQUISITIONS OF FIXED ASSETS				YEAR 1	\$921,438	
				YEAR 2	\$3,664,811	
				YEAR 3	\$7,025,770	
TOTAL				<u>\$11,612,018</u>		

IVIEWIT HOLDINGS, INC.
 ACCOUNTS RECEIVABLE ANALYSIS
 FOR THE THREE YEARS FROM EXPANSION OF OPERATIONS

	MONTH 1	MONTH 2	MONTH 3	MONTH 4	MONTH 5	MONTH 6	MONTH 7	MONTH 8	MONTH 9	MONTH 10	MONTH 11	MONTH 12
MONTHLY SALES	\$112,174	\$117,474	\$123,657	\$160,931	\$168,534	\$177,404	\$336,979	\$352,899	\$371,473	\$545,378	\$571,143	\$601,204
CUMULATIVE MONTHLY SALES	\$112,174	\$229,648	\$353,304	\$514,235	\$682,769	\$860,172	\$1,197,152	\$1,550,051	\$1,921,524	\$2,466,901	\$3,038,045	\$3,639,248
COLLECTIONS												
1-30 DAYS (30%)		33,652	35,242	37,097	48,279	50,560	53,221	101,094	105,870	111,442	163,613	171,343
31-60 DAYS (40%)			44,870	46,989	49,463	64,372	67,413	70,962	134,792	141,160	148,589	218,151
61-90 DAYS (20%)				22,435	23,495	24,731	32,186	33,707	35,481	67,396	70,580	74,295
91-120 DAYS (6%)					6,730	7,048	7,419	9,656	10,112	10,644	20,219	21,174
TOTAL MONTHLY COLLECTIONS	\$0	\$33,652	\$80,112	\$106,521	\$127,967	\$146,712	\$160,240	\$215,418	\$286,254	\$330,642	\$403,001	\$484,963
CUMULATIVE MONTHLY COLLECTIONS	\$0	\$33,652	\$113,764	\$220,285	\$348,252	\$494,964	\$655,204	\$870,622	\$1,156,876	\$1,487,518	\$1,890,519	\$2,375,482
RESERVE FOR BAD DEBT (4%)					4,487	4,699	4,946	6,437	6,741	7,096	13,479	14,116
ACCOUNTS RECEIVABLE BALANCE	\$112,174	\$195,996	\$239,540	\$293,950	\$330,029	\$360,509	\$537,001	\$672,991	\$757,906	\$972,287	\$1,134,046	\$1,249,651
CHANGE IN ACCOUNTS RECEIVABLE	\$112,174	\$83,821	\$43,545	\$54,409	\$36,080	\$30,480	\$176,492	\$135,991	\$84,915	\$214,381	\$161,759	\$115,604

VIEWIT HOLDINGS, INC.
ACCOUNTS RECEIVABLE ANALYSIS
FOR THE THREE YEARS FROM EXPANSION OF OPERATIONS

	MONTH 13	MONTH 14	MONTH 15	MONTH 16	MONTH 17	MONTH 18	MONTH 19	MONTH 20	MONTH 21	MONTH 22	MONTH 23	MONTH 24
MONTHLY SALES	\$1,063,564	\$1,113,812	\$1,172,433	\$1,540,136	\$1,612,898	\$1,697,788	\$2,251,068	\$2,357,417	\$2,481,492	\$3,011,901	\$3,154,195	\$3,320,205
CUMULATIVE MONTHLY SALES	\$4,702,813	\$5,816,625	\$6,989,058	\$8,529,194	\$10,142,092	\$11,839,879	\$14,090,947	\$16,448,365	\$18,929,857	\$21,941,757	\$25,095,952	\$28,416,158
COLLECTIONS												
1-30 DAYS (30%)	180,361	319,069	334,143	351,730	462,041	483,869	509,336	675,320	707,225	744,448	903,570	946,259
31-60 DAYS (40%)	228,457	240,481	425,426	445,525	468,973	616,054	645,159	679,115	900,427	942,967	992,597	1,204,760
61-90 DAYS (20%)	109,076	114,239	120,241	212,713	222,762	234,487	308,027	322,580	339,558	450,214	471,483	496,298
91-120 DAYS (6%)	22,288	32,723	34,269	36,072	63,814	66,829	70,346	92,408	96,774	101,867	135,064	141,445
TOTAL MONTHLY COLLECTIONS	\$540,182	\$706,502	\$914,079	\$1,046,040	\$1,217,590	\$1,401,239	\$1,532,869	\$1,769,423	\$2,043,984	\$2,239,495	\$2,502,715	\$2,788,762
CUMULATIVE MONTHLY COLLECTIONS	\$2,915,664	\$3,622,166	\$4,536,245	\$5,582,285	\$6,799,875	\$8,201,114	\$9,733,983	\$11,503,406	\$13,547,390	\$15,786,885	\$18,289,600	\$21,078,362
RESERVE FOR BAD DEBT (4%)	14,859	21,815	22,846	24,048	42,543	44,552	46,897	61,605	64,516	67,912	90,043	94,297
ACCOUNTS RECEIVABLE BALANCE	\$1,772,290	\$2,172,643	\$2,429,967	\$2,922,861	\$3,299,674	\$3,594,213	\$4,310,067	\$4,883,353	\$5,317,951	\$6,086,961	\$6,716,310	\$7,243,499
CHANGE IN ACCOUNTS RECEIVABLE	\$522,639	\$400,353	\$257,324	\$492,894	\$376,813	\$294,539	\$715,854	\$573,286	\$434,598	\$769,010	\$629,349	\$527,189

IVIEWIT HOLDINGS, INC.
 ACCOUNTS RECEIVABLE ANALYSIS
 FOR THE THREE YEARS FROM EXPANSION OF OPERATIONS

	MONTH 25	MONTH 26	MONTH 27	MONTH 28	MONTH 29	MONTH 30	MONTH 31	MONTH 32	MONTH 33	MONTH 34	MONTH 35	MONTH 36
MONTHLY SALES	\$3,873,483	\$4,056,483	\$4,269,982	\$4,648,870	\$4,868,501	\$5,124,738	\$5,451,592	\$5,709,147	\$6,009,629	\$6,292,380	\$6,589,658	\$6,936,482
CUMULATIVE MONTHLY SALES	\$32,289,641	\$36,346,124	\$40,616,106	\$45,264,975	\$50,133,477	\$55,258,215	\$60,709,807	\$66,418,954	\$72,428,583	\$78,720,963	\$85,310,621	\$92,247,104
COLLECTIONS												
1-30 DAYS (30%)	996,062	1,162,045	1,216,945	1,280,995	1,394,661	1,460,550	1,537,421	1,635,478	1,712,744	1,802,889	1,887,714	1,976,897
31-60 DAYS (40%)	1,261,678	1,328,082	1,549,393	1,622,593	1,707,993	1,859,548	1,947,401	2,049,895	2,180,637	2,283,659	2,403,852	2,516,952
61-90 DAYS (20%)	602,380	630,839	664,041	774,697	811,297	853,996	929,774	973,700	1,024,948	1,090,318	1,141,829	1,201,926
91-120 DAYS (6%)	148,890	180,714	189,252	199,212	232,409	243,389	256,199	278,932	292,110	307,484	327,096	342,549
TOTAL MONTHLY COLLECTIONS	\$3,009,009	\$3,301,680	\$3,619,631	\$3,877,497	\$4,146,359	\$4,417,484	\$4,670,795	\$4,938,005	\$5,210,439	\$5,484,350	\$5,760,491	\$6,038,324
CUMULATIVE MONTHLY COLLECTIONS	\$24,087,371	\$27,389,051	\$31,008,682	\$34,886,179	\$39,032,538	\$43,450,022	\$48,120,817	\$53,058,822	\$58,269,261	\$63,753,611	\$69,514,102	\$75,552,426
RESERVE FOR BAD DEBT (4%)	99,260	120,476	126,168	132,808	154,939	162,259	170,799	185,955	194,740	204,990	218,064	228,366
ACCOUNTS RECEIVABLE BALANCE	\$8,103,010	\$8,836,597	\$9,481,256	\$10,245,988	\$10,945,999	\$11,645,934	\$12,418,191	\$13,174,178	\$13,964,583	\$14,762,363	\$15,578,456	\$16,466,312
CHANGE IN ACCOUNTS RECEIVABLE	\$859,511	\$733,586	\$644,659	\$764,733	\$700,011	\$699,935	\$772,257	\$755,987	\$790,405	\$797,780	\$816,093	\$887,856

FOR THE THREE YEARS FROM EXPANSION
OF OPERATIONS

	Q1	Q2	Q3	Q4	Q5	Q6	Q7	Q8	Q9	Q10	Q11	Q12	TOTAL
Cost of Goods Sold	\$ 338,737	\$ 458,364	\$ 537,891	\$ 722,461	\$ 1,195,421	\$ 1,484,193	\$ 1,822,541	\$ 2,115,290	\$ 2,952,956	\$ 3,149,072	\$ 3,419,223	\$ 3,671,182	\$ 21,867,332
Marketing Expense	1,390,144	1,480,539	1,514,785	1,688,425	1,799,346	2,147,194	2,616,939	3,082,520	3,651,956	4,136,047	4,605,795	5,082,501	33,206,195
Corporate Expense	1,785,804	586,763	622,211	793,110	822,208	937,024	1,069,026	1,366,724	1,489,105	1,691,425	1,894,765	2,238,507	15,316,670
R&D Expense	149,696	200,327	199,968	226,335	306,366	467,679	465,344	465,698	666,108	673,547	672,965	673,584	5,167,616
Income Taxes										576,636	2,591,715	3,221,765	6,390,116
Depreciation Expense	(37,753)	(37,753)	(37,753)	(37,753)	(256,337)	(256,337)	(256,337)	(256,337)	(762,618)	(762,618)	(762,618)	(762,618)	(4,226,835)
production	(11,200)	(11,200)	(11,200)	(11,200)	(65,800)	(65,800)	(65,800)	(65,800)	(99,400)	(99,400)	(99,400)	(99,400)	(705,600)
cost of sales													
Total Expenses Without	\$ 3,615,428	\$ 2,677,039	\$ 2,825,902	\$ 3,381,376	\$ 3,801,205	\$ 4,713,952	\$ 5,671,713	\$ 6,718,095	\$ 7,898,107	\$ 9,364,710	\$ 12,322,445	\$ 14,025,521	\$ 77,015,494
Depreciation or Fixed Assets													
Payroll & Investment Banking Fee													
Cost of Goods Sold	\$ 118,688	\$ 208,500	\$ 262,063	\$ 315,063	\$ 408,997	\$ 517,988	\$ 642,666	\$ 772,066	\$ 809,947	\$ 885,637	\$ 963,549	\$ 1,041,669	\$ 6,946,830
Marketing Expense	166,250	210,000	228,750	247,500	299,563	339,250	383,938	422,375	477,041	518,713	546,884	568,494	4,408,756
Corporate Expense	290,750	290,750	290,750	326,500	341,038	341,038	341,038	342,825	358,089	358,089	358,089	359,966	3,998,922
Investment Banking Fee	1,200,000												1,200,000
R&D Expense	49,250	84,250	84,250	101,750	156,713	272,213	272,213	273,088	409,548	417,073	417,073	417,992	2,955,411
Network - Allocated	36,813	41,500	55,188	55,188	57,028	57,263	57,947	57,947	59,880	60,126	60,844	60,844	660,565
Total Payroll	1,861,750	835,000	921,000	1,046,000	1,263,338	1,527,750	1,697,800	1,868,300	2,114,504	2,239,638	2,346,440	2,448,965	20,170,484
Sales Commissions - Mktg.	52,996	74,652	156,484	252,455	493,543	710,952	1,037,544	1,385,108	1,778,107	2,128,815	2,492,831	2,875,065	13,438,552
Income Taxes										576,636	2,591,715	3,221,765	6,390,116
All Other Expenses													
Cost of Goods Sold	171,096	200,911	226,876	358,446	464,287	644,068	857,738	1,021,087	1,280,991	1,401,417	1,593,656	1,767,495	9,988,067
Marketing Expense	1,143,851	1,162,672	1,087,439	1,143,238	959,813	1,047,292	1,145,312	1,234,892	1,345,407	1,436,958	1,514,050	1,586,913	14,807,839
Corporate Expense	284,650	274,052	297,139	414,522	403,793	465,728	555,683	752,362	765,342	863,498	965,170	1,207,110	7,249,048
R&D Expense	96,285	110,967	109,239	117,626	142,511	187,820	185,417	184,895	248,652	248,541	247,888	247,588	2,127,429
Network - Allocated	4,800	9,600	9,600	14,400	14,400	19,200	19,200	19,200	19,200	19,200	19,200	19,200	187,200
Total Other Expense	1,700,682	1,758,201	1,730,283	2,048,232	1,984,804	2,364,107	2,763,350	3,212,436	3,659,592	3,969,614	4,339,964	4,828,307	34,359,583
Bad Debt Expense		9,186	18,125	34,691	59,520	111,143	173,019	252,251	345,904	450,007	551,494	651,419	2,656,758
Total Expenses	\$ 3,615,428	\$ 2,677,039	\$ 2,825,902	\$ 3,381,376	\$ 3,801,205	\$ 4,713,952	\$ 5,671,713	\$ 6,718,095	\$ 7,898,107	\$ 9,364,710	\$ 12,322,445	\$ 14,025,521	\$ 77,015,494

	M1	M2	M3	M4	M5	M6	M7	M8	M9	M10	M11	M12
Payroll & Investment Banking Fee												
Cost of Goods Sold	37,683	39,464	41,541	66,199	69,326	72,975	83,205	87,136	91,722	100,032	104,758	110,272
Marketing Expense	52,784	118,688	58,188	66,675	69,825	73,500	72,628	262,063	80,063	78,581	82,294	86,625
Corporate Expense	96,917	166,250	96,917	96,917	210,000	96,917	96,917	228,750	96,917	108,833	247,500	108,833
Investment Banking Fee	1,200,000	290,750			290,750			290,750			326,500	
R&D Expense	16,417	1,200,000	16,417	28,083	28,083	28,083	28,083	28,083	28,083	33,917	33,917	33,917
Network - Allocated	12,271	49,250	12,271	13,833	13,833	13,833	18,396	18,396	18,396	18,396	18,396	18,396
Total Payroll	1,416,072	220,346	225,332	271,707	277,985	285,308	299,229	306,591	315,180	339,759	348,198	358,043
Sales Commissions - Mktg.	16,826	17,621	18,548	23,702	24,822	26,128	49,684	52,031	54,769	80,154	83,941	88,359
Income Taxes	52,996	74,652						156,484			252,455	
All Other Expenses												
Cost of Goods Sold	54,323	56,869	59,884	63,789	66,803	70,319	72,033	75,436	79,406	113,807	119,183	125,456
Marketing Expense	363,173	171,096	400,348	369,148	386,588	406,935	345,262	226,876	380,604	362,978	380,127	400,133
Corporate Expense	94,883	1,143,851	94,883	91,351	1,162,672	91,351	99,046	1,087,439	99,046	138,174	1,143,238	138,174
R&D Expense	32,095	284,650	32,095	36,989	274,052	36,989	36,413	297,139	36,413	39,209	414,522	39,209
Network - Allocated	1,600	96,285	1,600	3,200	110,967	3,200	3,200	109,239	3,200	4,800	117,626	4,800
Total Other Expenses	546,074	565,798	588,810	564,477	584,931	608,793	555,954	575,669	598,670	658,967	681,492	707,772
Total Monthly Expenses without Bad Debts	1,978,972	803,765	832,691	859,886	887,737	920,230	904,867	934,291	968,619	1,078,881	1,113,632	1,154,174

	M13	M14	M15	M16	M17	M18	M19	M20	M21	M22	M23	M24
Payroll & Investment Banking Fee												
Cost of Goods Sold	129,857	135,991	143,149	164,461	172,231	181,296	204,046	213,686	224,933	245,131	256,712	270,223
Marketing Expense	95,111	408,997	104,847	107,712	517,988	118,738	121,900	642,666	134,378	134,104	772,066	147,831
Corporate Expense	113,679	299,563	113,679	113,679	339,250	113,679	113,679	383,938	113,679	114,275	422,375	114,275
Investment Banking Fee		341,038			341,038			341,038			342,825	
R&D Expense	52,238	52,238	52,238	90,738	90,738	90,738	90,738	90,738	90,738	91,029	91,029	91,029
Network - Allocated	19,009	156,713	19,009	19,088	272,213	19,088	19,316	272,213	19,316	19,316	273,088	19,316
Total Payroll	409,894	420,522	432,922	495,677	508,536	523,537	549,679	565,078	583,043	603,855	621,771	642,674
Sales Commissions - Mktg.	156,700	164,103	172,740	225,727	236,391	248,833	329,420	344,983	363,140	439,772	460,548	484,788
Income Taxes		493,543			710,952			1,037,544			1,385,108	

All Other Expenses												
Cost of Goods Sold	147,411	154,375	162,500	204,492	214,153	225,424	272,332	285,198	300,208	324,195	339,511	357,380
Marketing Expense	304,741	464,287	335,935	332,515	644,068	366,552	363,637	857,738	400,859	392,078	1,021,087	432,212
Corporate Expense	134,598	959,813	134,598	155,243	1,047,292	155,243	185,228	1,145,312	185,228	250,787	1,234,892	250,787
R&D Expense	47,504	403,793	47,504	62,607	465,728	62,607	61,806	555,683	61,806	61,632	752,362	61,632
Network - Allocated	4,800	142,511	4,800	6,400	187,820	6,400	6,400	61,806	6,400	6,400	184,895	6,400
Total Other Expenses	639,053	660,415	685,336	761,256	786,626	816,225	889,402	919,448	954,501	1,035,092	1,068,932	1,108,412

Total Monthly Expenses without Bad Debts	1,205,647	1,245,040	1,290,998	1,482,660	1,531,553	1,588,596	1,768,501	1,829,509	1,900,665	2,078,719	2,151,252	2,235,873
--	-----------	-----------	-----------	-----------	-----------	-----------	-----------	-----------	-----------	-----------	-----------	-----------

	M25	M26	M27	M28	M29	M30	M31	M32	M33	M34	M35	M36	Total
Payroll & Investment Banking Fee													
Cost of Goods Sold	257,158	269,307	283,481	281,190	294,474	309,973	305,927	320,380	337,242	330,730	346,355	364,584	6,946,830
Marketing Expense	151,460	809,947	166,964	164,691	172,472	181,549	173,636	181,839	191,410	180,497	1,041,669	198,973	4,408,756
Corporate Expense	119,363	477,041	119,363	119,363	518,713	119,363	119,363	119,363	119,363	119,989	568,494	119,989	4,408,756
Investment Banking Fee	-	358,089	-	-	358,089	-	-	358,089	-	-	359,966	-	3,998,922
R&D Expense	136,516	136,516	136,516	139,024	139,024	139,024	139,024	139,024	139,024	139,331	139,331	139,331	1,200,000
Network - Allocated	19,960	409,548	19,960	20,042	417,073	20,042	20,281	20,281	20,281	20,281	417,992	20,281	2,955,411
Total Payroll	684,457	703,762	726,285	724,310	745,376	769,952	758,231	780,888	807,321	790,827	814,980	843,158	660,565
Sales Commissions - Mktg.	564,549	591,220	622,337	675,899	707,831	745,085	791,474	828,866	872,491	912,833	955,959	1,006,273	13,438,552
Income Taxes	-	1,778,107	-	2,128,815	-	2,492,831	-	2,591,715	-	2,875,065	-	-	13,438,552
All Other Expenses													
Cost of Goods Sold	406,715	425,930	448,347	444,950	465,971	490,496	505,986	529,891	557,780	561,180	587,692	618,623	9,988,067
Marketing Expense	427,167	1,280,991	470,893	456,234	1,401,417	502,935	480,711	1,593,656	529,918	503,845	1,767,495	555,420	9,988,067
Corporate Expense	255,114	1,345,407	255,114	287,833	1,436,958	287,833	321,723	1,514,050	321,723	402,370	1,586,913	402,370	14,807,839
R&D Expense	82,884	765,342	82,884	82,847	863,498	82,847	82,629	965,170	82,629	82,529	82,529	82,529	7,249,048
Network - Allocated	6,400	248,652	6,400	6,400	248,541	6,400	6,400	247,888	6,400	6,400	247,588	6,400	2,127,429
Total Other Expenses	1,178,279	1,217,675	1,263,637	1,278,264	1,320,839	1,370,511	1,397,449	1,444,065	1,498,450	1,556,324	1,606,640	1,665,342	187,200
Total Monthly Expenses without Bad Debts	2,427,286	2,512,658	2,612,259	2,678,473	2,774,046	3,462,184	3,753,139	3,914,676	4,103,135	4,263,829	4,447,813	4,662,460	74,358,736

VIEWIT HOLDINGS, INC.
 ACCOUNTS PAYABLE ANALYSIS
 FOR THE THREE YEARS FROM EXPANSION OF OPERATIONS

	MONTH 1	MONTH 2	MONTH 3	MONTH 4	MONTH 5	MONTH 6	MONTH 7	MONTH 8	MONTH 9	MONTH 10	MONTH 11	MONTH 12
MONTHLY EXPENSES	\$1,978,972	\$803,765	\$832,691	\$859,886	\$887,737	\$920,230	\$904,867	\$934,291	\$968,619	\$1,078,881	\$1,113,632	\$1,154,174
CUMULATIVE MONTHLY EXPENSES	\$1,978,972	\$2,782,737	\$3,615,428	\$4,475,314	\$5,363,051	\$6,283,281	\$7,188,148	\$8,122,439	\$9,091,058	\$10,169,940	\$11,283,571	\$12,437,745
PAYMENTS:												
Payroll (Bi-Weekly at the end of that period)	216,072	220,346	225,332	271,707	277,985	285,308	299,229	306,591	315,180	339,759	348,198	358,043
Investment Banking Fees (first mo. of Qtr.)	1,200,000	0	0	0	0	0	0	0	0	0	0	0
Sales Commissions (Semi-monthly in arrears)	8,413	17,224	18,085	21,125	24,262	25,475	37,906	50,857	53,400	67,462	82,048	86,150
Income Taxes (One month in arrears)	0	0	0	0	0	0	0	0	0	0	0	0
All Other Expenses:												
Year One:												
1-30 days 80%	436,859	452,639	471,048	451,582	467,945	487,035	444,763	460,535	478,936	527,174	545,194	566,218
31-60 days 20%	0	109,215	113,160	117,762	112,895	116,986	121,759	111,191	115,134	119,734	131,793	136,298
Year Two:												
1-30 days 60%												
31-60 days 40%												
Year Three:												
1-30 days 50%												
31-60 days 50%												
TOTAL MONTHLY PAYMENTS	\$1,861,344	\$799,423	\$827,625	\$862,176	\$883,087	\$914,804	\$903,657	\$929,174	\$962,650	\$1,054,129	\$1,107,233	\$1,146,709
CUMULATIVE MONTHLY PAYMENTS	\$1,861,344	\$2,660,767	\$3,488,392	\$4,350,568	\$5,233,654	\$6,148,459	\$7,052,116	\$7,981,290	\$8,943,940	\$9,998,069	\$11,105,302	\$12,252,011
ACCOUNTS PAYABLE BALANCE	\$117,628	\$121,970	\$127,036	\$124,746	\$129,397	\$134,823	\$136,033	\$141,149	\$147,119	\$171,871	\$178,269	\$185,734
CHANGE IN ACCOUNTS PAYABLE	\$117,628	\$4,342	\$5,066	(\$2,290)	\$4,651	\$5,426	\$1,210	\$5,117	\$5,969	\$24,752	\$6,398	\$7,465

VIEWIT HOLDINGS, INC.
ACCOUNTS PAYABLE ANALYSIS
FOR THE THREE YEARS FROM EXPANSION OF OPERATIONS

	MONTH 13	MONTH 14	MONTH 15	MONTH 16	MONTH 17	MONTH 18	MONTH 19	MONTH 20	MONTH 21	MONTH 22	MONTH 23	MONTH 24
MONTHLY EXPENSES	\$1,205,647	\$1,245,040	\$1,290,998	\$1,482,660	\$1,531,553	\$1,588,596	\$1,768,501	\$1,829,509	\$1,900,685	\$2,078,719	\$2,151,252	\$2,235,873
CUMULATIVE MONTHLY EXPENSES	\$13,643,392	\$14,888,432	\$16,179,430	\$17,662,090	\$19,193,644	\$20,782,239	\$22,550,740	\$24,380,249	\$26,280,933	\$28,359,652	\$30,510,904	\$32,746,777
PAYMENTS:												
Payroll (Bi-Weekly at the end of their period)	409,894	420,522	432,922	495,677	508,536	523,537	549,679	565,078	583,043	603,855	621,771	642,674
Investment Banking Fees (first mo. of Qtr.)	0	0	0	0	0	0	0	0	0	0	0	0
Sales Commissions (Semi-monthly in arrears)	122,530	160,402	168,422	199,234	231,059	242,612	289,127	337,202	354,062	401,456	450,160	472,668
Income Taxes (One month in arrears)	0	0	0	0	0	0	0	0	0	0	0	0
All Other Expenses:												
Year One:												
1-30 days	141,554											
31-60 days												
Year Two:												
1-30 days	383,432	396,249	411,202	456,754	471,976	489,735	533,641	551,669	572,701	621,055	641,359	665,047
31-60 days		255,621	264,166	274,135	304,502	314,651	326,490	355,761	367,779	381,800	414,037	427,573
Year Three:												
1-30 days												
31-60 days												
TOTAL MONTHLY PAYMENTS	\$1,057,410	\$1,232,794	\$1,276,711	\$1,425,799	\$1,516,073	\$1,570,535	\$1,698,937	\$1,809,709	\$1,877,585	\$2,008,166	\$2,127,327	\$2,207,562
CUMULATIVE MONTHLY PAYMENTS	\$13,309,421	\$14,542,214	\$15,818,925	\$17,244,724	\$18,760,797	\$20,331,333	\$22,030,269	\$23,839,978	\$25,717,563	\$27,725,729	\$29,853,057	\$32,061,019
ACCOUNTS PAYABLE BALANCE	\$333,971	\$346,217	\$360,505	\$417,366	\$432,846	\$450,907	\$520,471	\$540,271	\$563,371	\$633,923	\$657,847	\$685,758
CHANGE IN ACCOUNTS PAYABLE	\$148,237	\$12,246	\$14,287	\$56,861	\$15,480	\$18,060	\$69,564	\$19,800	\$23,100	\$70,552	\$23,924	\$27,912

VIEWIT HOLDINGS, INC.
ACCOUNTS PAYABLE ANALYSIS
FOR THE THREE YEARS FROM EXPANSION OF OPERATIONS

	MONTH 25	MONTH 26	MONTH 27	MONTH 28	MONTH 29	MONTH 30	MONTH 31	MONTH 32	MONTH 33	MONTH 34	MONTH 35	MONTH 36
MONTHLY EXPENSES	\$2,427,286	\$2,512,658	\$2,612,259	\$2,678,473	\$2,774,046	\$3,462,184	\$3,753,139	\$3,914,676	\$4,103,135	\$4,263,829	\$4,447,813	\$4,662,460
CUMULATIVE MONTHLY EXPENSES	\$35,174,063	\$37,686,721	\$40,298,980	\$42,977,453	\$45,751,499	\$49,213,684	\$52,966,823	\$56,881,499	\$60,984,634	\$65,248,463	\$69,696,276	\$74,358,736
PAYMENTS:												
Payroll (Bi-Weekly at the end of that period)	684,457	703,762	726,285	724,310	745,376	769,952	758,231	780,888	807,321	790,827	814,980	843,158
Investment Banking Fees (first mo. of Qtr.)	0	0	0	0	0	0	0	0	0	0	0	0
Sales Commissions (Semi-monthly in arrears)	524,668	577,885	606,779	649,118	691,865	726,458	768,280	810,170	850,679	892,662	934,396	981,116
Income Taxes (One month in arrears)	0	0	0	0	0	0	576,636	805,984	860,857	924,874	1,003,844	1,070,233
All Other Expenses:												
Year One:												
1-30 days 80%												
31-60 days 20%												
Year Two:												
1-30 days 60%												
31-60 days 40%												
Year Three:												
1-30 days 50%												
31-60 days 50%												
TOTAL MONTHLY PAYMENTS	\$2,241,630	\$2,479,624	\$2,573,720	\$2,644,379	\$2,736,792	\$2,842,085	\$3,487,128	\$3,817,800	\$3,990,113	\$4,135,750	\$4,334,703	\$4,530,498
CUMULATIVE MONTHLY PAYMENTS	\$34,302,649	\$36,782,273	\$39,355,993	\$42,000,372	\$44,737,164	\$47,579,249	\$51,066,377	\$54,884,176	\$58,874,290	\$63,010,040	\$67,344,743	\$71,875,241
ACCOUNTS PAYABLE BALANCE	\$871,414	\$904,448	\$942,987	\$977,081	\$1,014,335	\$1,634,435	\$1,900,446	\$1,997,322	\$2,110,344	\$2,238,423	\$2,351,533	\$2,483,495
CHANGE IN ACCOUNTS PAYABLE	\$185,656	\$33,034	\$38,539	\$34,094	\$37,254	\$620,099	\$266,012	\$96,876	\$113,022	\$128,079	\$113,110	\$131,962



Lorraine Christine Hoffman, Esq.
Assistant Staff Counsel
The Florida Bar
File No. 2003-51, 109(15C)

Exhibit D – Joao Response to New York Bar



IVIEWIT HOLDINGS, INC.

By Facsimile

February 26, 2003

Thomas J. Cahill
Chief Counsel
First Judicial Department Departmental Disciplinary Committee
61 Broadway, 2nd Floor
New York, New York 10006

Re: General Complaint against Raymond Anthony Joao on Behalf of Iviewit Holdings, Inc. (a Delaware Corporation) ("Company")

Dear Mr. Cahill:

By way of introduction, I am President (Acting) of the above referenced Company, and write to file a General Complaint against the following member of the New York State Bar Association:

Raymond Joao, Esquire
122 Bellevue Place
Yonkers, NY 10703
914-969-2992

Introduction

Raymond A. Joao, (hereinafter "Joao"), believed to be a resident of the State of New York, and who at various times relevant hereto was initially misrepresented to the Company as a partner of Proskauer Rose LLP (hereinafter "Proskauer") and was factually a partner of Meltzer Lippe Goldstein and Schlissel, and who provided legal services to the Company.

Moreover, beginning on or about September of 1998, the Company, through its agent and principal, Eliot I. Bernstein ("Bernstein"), began negotiations with Proskauer with regard to Proskauer providing legal services to the Company the purpose of which was to develop and market specific technologies developed by Bernstein and two others, which technologies allowed for the scaling, enlargement, panning and zooming of digital images and video without degradation to the quality of the digital image due to what is commonly referred to as "pixelation", the delivery of digital video using proprietary scaling techniques, a combination of the image pan and zoom techniques and video scaling techniques, and the remote control of video and image applications.



Furthermore, Bernstein engaged the services of Proskauer and in turn Joao, among others, through an engagement letter a true copy of which I attach herein as Exhibit "A", to obtain multiple patents and oversee US and foreign filings for such technologies including the provisional filings for the technologies as described above, and such other activities as were necessary to protect the intellectual property.

Additionally, upon information and belief, Joao upon viewing the technologies developed by Bernstein, and held by the Company, realized the significance of the technologies, its various applications to communication networks for distributing video data and images and for existing digital processes, including, but not limited to digital cameras, digital video disks (DVD), digital imaging technologies for medical purposes and digital video, and that Rubenstein designed and executed, sometimes for himself or others similarly situated, deceptions, improprieties, and, even in certain circumstances, outright malfeasances by the disingenuous insertion of his own interests or the interests of third parties, who were other clients of Proskauer and/or Meltzer Lippe Goldstein and Schlissel, between the Company, as his client and together with its disclosed techniques, and the ultimate end users of its future OEM and other licensees, to the detriment and damage of the Company. Many of the malfeasances against the Company have also involved fraud against the US Patent and Trademark Office.

Specifics of General Complaint

Where the Company employed Joao, Proskauer and Meltzer Lippe Goldstein & Schlissel for purposes of representing the Company to obtain multiple patents and oversee foreign filings for such technologies including the provisional filings for the technologies as described above, and that pursuant to such employment, Joao, Proskauer and Meltzer Lippe Goldstein & Schlissel owed a duty to ensure that the rights and interests of the Company were protected, Joao, Proskauer and Meltzer Lippe Goldstein & Schlissel neglected that reasonable duty of care in the performance of legal services in that they:

- a. Failed to take reasonable steps to ensure that the intellectual property of the Company was protected; and,
- b. Failed to and/or inadequately completed work regarding patents, copyrights and trademarks; and,
- c. Failed to list proper inventors of the technologies based on improper legal advise by Proskauer, and in turn Joao in his lead technological role, that foreign inventors could not be listed until their immigration status was adjusted leading to further erroneous billings by Proskauer for frivolous immigration work. This resulted in the failure of the patents to include their rightful and lawful inventors; and,
- d. Failed to ensure that the patent applications for the technologies, contained all necessary and pertinent information relevant to the technologies and as required by law; and,
- e. Falsified billing statements and transmitted documents, and,



f. Falsified patent documents and changed the contents of patents prior to filing so as to make the Company patents weak and inaccurate, so as to file patents in his own name that would succeed upon the Companies patents failing. That Mr. Joao who was contracted to procure patents for the Company has now applied for 70+ patents in his own name, many of which appear to be ideas learned while representing the Company.

g. That due to the discovery of many of the above described events the Company's lead investor Crossbow Ventures (a referral of Proskauer Rose) of West Palm Beach, Fla., pulled funding on the Company.

Lastly, the negligent actions of Joao, MLGS and Proskauer resulted in and were the proximate cause of loss to the Company; today, the Company's processes are believed to be on digital camera's, DVD's and virtually all Internet and Broadcast streams of video; true copies of exhibits and witnesses are available on request and/or I will, on behalf of the Company, present them according to proof at commencement of investigation into this General Complaint.

Due to the highly sensitive nature of the patent and copyright materials, exhibits and witnesses will be provided once formal protections have been established in regard to this complaint.

Very truly yours,

IVIEWIT HOLDINGS, INC.

By: : Electronic Signature

Eliot I Bernstein
561.364.4240
President

Electronic Signature for P. Stephen Lamont by Eliot I. Bernstein his attorney -in-fact

P. Stephen Lamont
Chief Executive Officer

RAYMOND A. JOAO, ESQ.
122 BELLEVUE PLACE
YONKERS, NY 10703
(914) 969-2992

April 8, 2003

BY FEDERAL EXPRESS

Thomas J. Cahill, Esq.
Chief Counsel
Departmental Disciplinary Committee
Supreme Court, Appellate Division
First Judicial Department
61 Broadway
New York, New York 10006
Attention: Mr. Joseph G. Wigley

Re: Complaint of Mr. Eliot I. Bernstein
Docket No. 2003.0532

Dear Mr. Cahill:

This is my response, pursuant to 22 NYCRR § 605.6(d), to the Complaint of Eliot I. Bernstein, president of Iviewit Holdings, Inc. ("Iviewit"), dated February 26, 2003 ("the Complaint").

I hereby deny each and every one of the general and specific allegations in the Complaint. Those allegations are simply untrue.

In addition, the allegations in the Complaint are vague and unsubstantiated and do not allege specific violations of the Disciplinary Rules of the Code of Professional Responsibility.

APR 08 2003
10:21 AM
FEDERAL EXPRESS
10006 NY NY

Finally, I believe that the Complaint was filed in retaliation to an action that Proskauer Rose LLP ("Proskauer") has brought against Iviewit to recover substantial unpaid legal fees.

For the reasons set forth below, I respectfully request that the Office of Chief Counsel recommend to the Committee that the Complaint against me be dismissed without referral.

I. THIS ANSWER IS BEING FILED WITHOUT HAVING ACCESS TO THE PERTINENT IVIEWIT PATENT FILES.

I do not have access to any of the Iviewit files and documents, retainer agreements (where applicable) or client correspondences that Mr. Bernstein apparently relied on in order to file the Complaint.

Upon receiving the Complaint, I contacted Arnold Klein, Esq., a partner of the Mineola, New York law firm of Meltzer, Lippe & Goldstein and requested access to its files for Iviewit, including any retainer agreements. During the time period of the Complaint, I was Of Counsel and Head of the Intellectual Property/Technology Rights Group of Meltzer, Lippe, Goldstein & Schlissel, the predecessor law firm of Meltzer, Lippe & Goldstein (collectively, "MLG"). Mr. Klein informed me, however, that MLG no longer had its Iviewit files because, in or about May of 2000, it sent its original files to the Wisconsin office of the law firm of Foley & Lardner.

I then contacted Foley & Lardner attorney Steven Becker who informed me that its original Iviewit files had been transferred to the Los Angeles Office of Blakely, Sokoloff, Taylor & Zafman.

Upon contacting Blakely, Sokoloff, Taylor & Zafman, I was informed by Farzad Amini that Blakely, Sokoloff, Taylor & Zafman is Iviewit's patent counsel, and he refused to provide me with a copy of any documents in the Iviewit files that are pertinent to the Complaint without Iviewit's approval.

In view of my inability to obtain a copy of any documents in the Iviewit files that are pertinent to the Complaint, I must qualify all of the responses relating thereto as being based on my memory and/or from research I performed on publicly accessible computer databases.

II. MY BACKGROUND AND PERTINENT INFORMATION REGARDING MYSELF.

I have BS and MS degrees (1982 and 1984, respectively) in Electrical Engineering from the Columbia University School of Engineering and Applied Science. I have approximately six years of engineering work experience for defense contracting firms where I worked on various electrical and electronic systems relating to radar, sonar, microprocessor-based digital computers, and electronic warfare threat detection systems.

Thomas J. Cahill, Esq.
April 8, 2003
Page No. 4

I received my JD degree from the St. John's University School of Law in 1990. I was admitted in the Second Department in January 1991. I am admitted to practice before the United States Patent & Trademark Office as a Patent Attorney.

In 1999, I received an MBA in Finance from Baruch College of the City University of New York. I am currently enrolled in an MS Marketing program at Baruch, and I expect to receive that degree in due course.

In 1992, I began filing patent applications for my own inventions. To date, I have been awarded fifteen (15) United States Patents and have numerous other patents pending. I am currently devoting my full-time efforts towards commercializing my various intellectual properties.

On July 18, 1996, I filed a patent application in my name that disclosed a remote-controlled control, monitoring and/or security apparatus and method for vehicles, motor vehicles, marine vessels and vehicles, aircraft, recreational vehicles, residential premises and/or commercial premises. This patent application was allowed and was issued as United States Patent No. 5,917,405 (the "405 Patent") on June 29, 1999. A true copy of the 405 Patent is attached hereto as Exhibit A.

Among the many things disclosed in the 405 Patent is the use of a video recording device or a camera for providing respective video information, a picture, or an image, to a device by transmitting the respective video information, picture, or image, on or over a communication network or system. The communication network or system can be any

Thomas J. Cahill, Esq.
April 8, 2003
Page No. 5

communication network or system. The 405 Patent also discloses transmitting video information, a picture, or an image, on or over the Internet and/or the World Wide Web.

The 405 Patent also discloses the use of an audio recording device for providing audio information to a device by transmitting the audio information on or over a communication network or system. The communication network or system can be any communication network or system. The 405 Patent also discloses transmitting audio information on or over the Internet and/or the World Wide Web.

The 405 Patent also discloses an apparatus and method which can be used to any one or more of control, activate, deactivate, enable, and/or disable, any one or more of the vehicles, premises, systems, equipment systems, subsystems, equipment, devices, components, or appliances, disclosed in the 405 Patent via, on, or over, a communication network or system. The 405 Patent also discloses controlling any one or more of a video recording device, a camera, an audio recording device, a microphone, a tape recorder, etc., via a communication network or system. The 405 Patent also discloses performing any of the control, activation, deactivation, enabling, and/or disabling, operations on or over the Internet and/or the World Wide Web.

In April 2002, I received significant media attention and recognition for the 405 Patent for a use of the technology in controlling and/or monitoring aircraft remotely and for providing the capability of obtaining video information from an aircraft and/or for providing the capability of obtaining audio information from an aircraft. A copy of a

Thomas J. Cahill, Esq.
April 8, 2003
Page No. 6

New York Newsday article, dated April 22, 2002, is representative of the attention that I received for the 405 Patent and is attached hereto as Exhibit B.

III. MY EMPLOYMENT RELATIONSHIP WITH MELTZER, LIPPE, GOLDSTEIN, & SCHLISSEL

In February of 1999, I joined the law firm of Meltzer, Lippe, Goldstein & Schlissel, the predecessor of MLG, in an Of Counsel capacity and as Head of the Intellectual Property/Technology Rights Group. I joined that firm to assist its efforts to restart an Intellectual Property Group after the previous group, which included Kenneth Rubenstein, Esq., had left in 1998 to join the Proskauer firm. I resigned from Meltzer, Lippe, Goldstein & Schlissel on April 19, 2000.

I was never a partner at Meltzer, Lippe, Goldstein & Schlissel or its successor firm, MLG. I have never represented myself as being a partner of Meltzer, Lippe, Goldstein & Schlissel or its successor firm MLG, and I am not aware of any such misrepresentations made to that effect to Iviewit by any third party.

Similarly, at no time was I ever a partner of Proskauer. I have never represented myself as being a partner of Proskauer, and I am not aware of any such misrepresentations made to that effect to Iviewit by any third party.

In or about February or March 1999, Mr. Rubenstein, who at the time was at Proskauer, contacted me to say that he was referring Eliot Bernstein to me because Mr. Bernstein had invented a new process or technique for compressing image and/or video information. Shortly thereafter, I had a conversation with Mr. Bernstein who informed

me that he had invented a new process or technique for performing a compression of an image file, that he was in the process of forming a company, and that he wanted to file a patent application for his invention. Mr. Bernstein asked me various questions concerning my experience and qualifications. Since these were questions which a competent businessman would and should ask in qualifying an attorney and especially a patent attorney, I provided him with information concerning my credentials and experience. I informed Mr. Bernstein that I had substantial experience in drafting and prosecuting high technology inventions and especially those relating to Internet and/or World Wide Web technologies. I also informed Mr. Bernstein that I was an inventor and that I had number of patents and patents pending for numerous inventions of my own. I described to Mr. Bernstein the general subject matter relating to my then soon-to-be issuing 405 Patent and some of its various features regarding transmitting video information *via* the Internet and/or the World Wide Web. I also explained to Mr. Bernstein that I specialized in helping inventors and start-up companies in developing patent portfolios to help them build and sustain a competitive advantage.

Sometime after the issuance of the 405 Patent on June 29, 1999, I informed Mr. Bernstein of the issuance of that patent and its patent number. I had discussed the 405 Patent with Mr. Bernstein from time to time. I would sometimes use my own patents as a teaching tool to show how non-provisional applications can be drafted and how inventive activities should be pursued in order to build upon innovations. Mr. Bernstein told me that he had read the 405 Patent.

With regard to payment for legal services, Mr. Bernstein informed me that, because Iviewit was in the start-up phase, he would only be able to pay, to the best of my recollection, from between \$3,000 and \$3,500 for a patent application. I informed him that this financial limitation would not be acceptable to Meltzer, Lippe, Goldstein & Schlissel in view of the effort and time typically required to prepare such an application.

On account of the inability of Iviewit to pay for a patent application, I informed Mr. Bernstein that I could instead prepare and file a provisional patent application. I explained that, by filing a provisional patent application, he could at least receive a "patent pending" status for his invention. In this regard, I told Mr. Bernstein that a provisional patent application is not a true patent application, but rather a so-called "time stamp". It is not a true patent application because no patent can ever issue from it. Rather, it is a priority document to enable an inventor to obtain "patent pending" status for an invention for a one-year period. In order to obtain a patent, an inventor must file a non-provisional patent application within one year of the provisional patent application filing date and claim the benefit of the priority of the previously filed provisional application. If a non-provisional application is not filed within the required one year time period, the ability to claim the priority to the filing date of the provisional application is forfeited. A priority date is key in determining patentability of an invention, as it is the date upon which the prior art relating to an invention is determined.

Upon Mr. Bernstein's insistence that he needed "patent pending" status to protect his invention, and given his financial constraints, I informed him that I would draft a

provisional patent application that would include only the information that he provided to me. I also informed him that I would prepare the first provisional patent application in the format of a more detailed non-provisional patent application for about \$3,000. I further informed Mr. Bernstein that Meltzer, Lippe, Goldstein & Schlissel and I would only undertake such a task if he signed a Retainer Agreement acknowledging that he understood the nature of a provisional patent application and that he agreed that I would only prepare a provisional application and no more. Mr. Bernstein agreed to these terms by signing a written Retainer Agreement, which MLG no longer has.

In the ensuing months, Mr. Bernstein came up with additional ideas for which he wanted to file patent applications. Provisional patent applications were filed for each of these alleged inventions as well.

In an attempt to ascertain the identity of the applications prepared and/or filed by me, on behalf of Iviewit, I conducted research using publicly accessible information. To the best of my knowledge, I prepared and/or filed the following eight provisional patent applications:

<u>Filing Date</u>	<u>Provisional Application Serial No.</u>
March 24, 1999	60/125,824
June 3, 1999	60/137,297
June 7, 1999	60/137,921
June 29, 1999	60/141,440
August 2, 1999	60/146,726
August 19, 1999	60/149,737
September 22, 1999	60/155,404
December 8, 1999	60/169,559

Thomas J. Cahill, Esq.
April 8, 2003
Page No. 10

Some of the above provisional patent applications were prepared in the more detailed format of a non-provisional patent application, while others were filed in a brief invention disclosure format. Each application was filed with Mr. Bernstein's direction, knowledge, and approval.

On March 10, 2000, pursuant to Mr. Bernstein's directions and within the required one-year time period, I filed a non-provisional patent application claiming priority to the March 24, 1999 provisional patent application. This non-provisional patent application was assigned U.S. Patent application Serial No. 09/522,721.

On or before March 24, 2000, I also recall filing a Patent Cooperation Treaty ("PCT") application with the United States Patent & Trademark Office. I have been unable to locate any information regarding this PCT application.

A PCT application is not a true patent application, *i.e.* it cannot issue as a patent unless an application is made to enter a national or regional stage for a particular country or region, respectively. Instead, a PCT application can be described, in a simple manner, as being a document that can be relied upon for priority in order to file a patent application in any desired number of PCT signatory countries or regions throughout the world. In essence, a PCT is a "time stamp" that can allow an inventor or applicant to file patents in any one or more of the 85 plus national patent offices (countries) or regional patent offices, which are signatories of the PCT Treaty, for up to 30 months from the original patent application filing date (*i.e.* an earliest filed and claimed provisional or non-provisional application). In effect, the PCT application allows an inventor to secure

an option to file patents in the signatory countries or regions for generally up to 30 months from the earliest application priority date. If no national or regional application is filed for a particular country or region within that 30 month time period, the PCT application priority right is forfeited as to those countries or regions for which filings had been foregone.

IV. MY PROCEDURE IN PREPARING AND FILING A PROVISIONAL OR NON-PROVISIONAL PATENT APPLICATION.

I follow a standard procedure in preparing and filing a patent application. Upon receiving an invention disclosure and/or meeting with an inventor, I draft the patent application. Depending upon the format of the application, I prepare a draft document and transmit a copy of it to the inventor and await comments or revisions. I then review those comments or revisions from a technical and legal standpoint. If I make changes to the first draft, I send the revised, second draft to the inventor for his or her approval. This process is repeated as necessary until the inventor approves of the final form of the application and instructs me to file the document. When a provisional patent application was to be filed from an invention disclosure, this procedure may or may not be followed. Only upon receiving the inventor's final approval to file the document, would I then file the approved version of the document as the respective provisional or non-provisional patent application.

I followed this procedure, when applicable, with regard to Mr. Bernstein's and Iviewit's patent applications, whether they were provisional, non-provisional, or PCT, in nature.

V. RESPONSES TO THE ALLEGATIONS OF THE GENERAL COMPLAINT

This section addresses the allegations set forth in the Complaint. All of the allegations accusing me of misconduct or a failure to use reasonable care are denied. Further, these allegations lack a factual basis and are false.

On page 1 of the Complaint, it is alleged that I was initially misrepresented to Iviewit as being a partner of Proskauer and that I was allegedly a partner of Meltzer, Lippe, Goldstein & Schlissel. This allegation is false. Neither I nor anyone else, to my knowledge, represented to either Iviewit or Mr. Bernstein that I was a partner of Proskauer or a partner of Meltzer, Lippe, Goldstein & Schlissel.

On page 2 of the Complaint, Mr. Bernstein alleges that he "engaged the services of Proskauer and in turn Joao, among others, through an engagement letter" attached as Exhibit "A". I did not receive a copy of this alleged engagement letter when the Office of Chief Counsel sent me the Complaint. Further, I am not aware of any arrangement between Proskauer and its clients that would have engaged either Meltzer, Lippe, Goldstein & Schlissel or myself. As I stated earlier, Mr. Bernstein executed a Retainer Agreement with Meltzer, Lippe, Goldstein & Schlissel for the purpose of having me

Thomas J. Cahill, Esq.
April 8, 2003
Page No. 13

prepare his March 1999 provisional patent application. This Retainer Agreement did not include Proskauer.

Mr. Bernstein's allegation that "Joao upon viewing the technologies developed by Bernstein, and held by the Company, realized the significance of the technologies, its various applications to communications networks for distributing video data images and for existing digital processes, including, but not limited to digital cameras, digital video disks (DVD), digital imaging technologies for medical purposes and digital video", to the extent understood, is denied in its entirety. Mr. Bernstein's alleged innovations involved digital image file compression techniques and/or digital video file compression techniques which were directed to what could be described to a lay person as a high tech processing or development of a digital rendition of an image or a video. As described above, various applications of transmitting images or video in a communication network were invented by myself as early as 1996. I have never ventured into the field of video file compression or image file compression. Further, Mr. Bernstein was aware of my 405 Patent as early as the summer of 1999. I deny appropriating any of Iviewit's alleged technologies.

I deny any allegations that malfeasances were perpetrated against Iviewit. I further deny that any fraud was perpetrated by myself against the U.S. Patent and Trademark Office.

VI. RESPONSES TO THE SPECIFIC ALLEGATIONS OF THE GENERAL COMPLAINT

I deny the allegation that I did not use reasonable care in performing legal services for either Iviewit or Mr. Bernstein. At all times, I provided Iviewit and Mr. Bernstein with the highest degree of care and attention.

My responses to each of the specific allegations are provided below.

A. I deny the allegation that I failed to take reasonable care to ensure that the intellectual property of Iviewit was protected. To the contrary, to the best of my recollection and through independent research, without having access to the Iviewit files, during the period from March 1999 through March 2000, I, through Meltzer, Lippe, Goldstein & Schlissel, filed eight provisional patent applications for Iviewit or Mr. Bernstein. These eight provisional patent applications are identified below:

<u>Filing Date</u>	<u>Provisional Application Serial No.</u>
March 24, 1999	60/125,824
June 3, 1999	60/137,297
June 7, 1999	60/137,921
June 29, 1999	60/141,440
August 2, 1999	60/146,726
August 19, 1999	60/149,737
September 22, 1999	60/155,404
December 8, 1999	60/169,559

During the same period, I, though Meltzer, Lippe, Goldstein & Schlissel, and pursuant to Mr. Bernstein's direction, filed a non-provisional patent application corresponding to, and claiming the benefit of the priority of, the March 24, 1999

Thomas J. Cahill, Esq.
April 8, 2003
Page No. 15

provisional patent application. This non-provisional patent application was filed on March 10, 2000 and was assigned U.S. Patent application Serial No. 09/522,721.

Pursuant to Mr. Bernstein's direction, I also filed a PCT application to claim priority to the March 24, 1999 provisional patent application on or before March 24, 2000.

I performed all reasonable steps to ensure that Iviewit's intellectual properties were protected in accordance with Mr. Bernstein's instructions. In any event, the Complaint does not allege what I did or failed to do that has left Iviewit's intellectual properties unprotected or at jeopardy.

B. I deny the allegation that I failed to and/or inadequately completed work regarding patents, copyrights and trademarks. First, Mr. Bernstein or Iviewit never asked me to perform any services with regards to copyrights and/or trademarks. Second, all the work that I performed was provided to Mr. Bernstein and, in certain instances to Mr. Brian Utley, then CEO of Iviewit, in a timely manner for review, for any suggestions, and for edits and/or revisions. I caused no provisional patent application, non-provisional patent application, and/or PCT application, to be filed without their approval. In instances when an invention disclosure was filed as a provisional patent application, in order to obtain the earliest possible filing date for the alleged invention, such filings also were made pursuant to their direction and with their knowledge and approval beforehand. Further, I never received any complaints regarding my work product and/or the patent

filing strategies being utilized. In any event, the Complaint does not allege how I allegedly failed to and/or inadequately completed work.

C. I deny the allegation that I failed to list proper inventors. At no time did Mr. Bernstein or any other person associated with Iviewit mention that others besides Mr. Bernstein were inventors of, or involved in the conception or reduction to practice of, the compression technologies that formed the basis for Iviewit's provisional patent applications, the non-provisional patent application, and the PCT application. To the contrary, Mr. Bernstein claimed sole inventorship for all provisional patent applications filed on Iviewit's behalf with the exception of, to the best of my recollection, one such application that also named Mr. Utley as an inventor. To the best of my recollection, I do recall Mr. Brian Utley being named as an inventor in a provisional patent application that may have been the application filed in December 1999. In this instance, I was specifically told that Mr. Utley was to be a named co-inventor of the technology disclosed in the application. Mr. Bernstein always had indicated and led me to believe that he was the only or sole inventor of the pertinent technology except in the instance when Mr. Utley was a named co-inventor on the pertinent patent application. I do not recall any other inventors being brought to my attention. Contrary to the allegations in the Complaint, Mr. Bernstein appears to continue his assertions to the present time that he is the sole inventor of the Iviewit technology. I attach hereto as Exhibit C a copy of a web page obtained from the Iviewit web site at www.iviewit.com, wherein Mr. Bernstein is described as the "Inventor of the I View It concept".

If, in fact, any foreigners or foreign nationals were co-inventors with Mr. Bernstein during the time when I represented Iviewit, such information was concealed from me. There was simply no good reason for Mr. Bernstein to have withheld this information from me. Furthermore, in filing the non-provisional patent application of March 10, 2000, I believe that such filing would normally include a Declaration by Mr. Bernstein attesting to the fact that he was the only or sole inventor of the invention disclosed therein. At the time of the filing of the March 10, 2000 non-provisional patent application, Mr. Bernstein again failed to mention any other and, in particular, any foreign inventors. This particular allegation is the first notice to me of these alleged two other inventors.

I further was unaware that any advice was allegedly being sought regarding any foreign inventors and the ability to name any such individuals as inventors in any patent application. I was also unaware that any alleged advice was being provided or that any alleged immigration work for any alleged foreign national(s) was being provided by Proskauer. The Complaint is my first knowledge of these allegations.

Mr. Bernstein never told me that Iviewit's technology was invented by any foreign inventors. Further, I was unaware of any legal advice given to Bernstein that the "immigration status" of these "foreign inventors" had to be "adjusted" before they could be listed as inventors in any type of United States Patent application. A foreign inventor can be listed at any time in a United States Patent application regardless of immigration status.

Thomas J. Cahill, Esq.
April 8, 2003
Page No. 18

Each and every provisional patent application that was filed with the United States Patent and Trademark Office was duly filed and received by the Office as evidenced by the assigning of a U.S. Provisional Patent Application Serial Number to each application. Further, the one non-provisional patent application that also was filed with the United States Patent and Trademark Office was duly filed and received by the Office as evidenced by the assigning of a U.S. Patent Application Serial Number to that application. I left Meltzer, Lippe, Goldstein & Schlissel in April 2000 and thereafter no longer represented Iviewit or Mr. Bernstein. After leaving Meltzer, Lippe, Goldstein & Schlissel, I was not asked to file any other or subsequent patent applications on behalf of Iviewit, Mr. Bernstein or any other inventors of any alleged Iviewit inventions. Subsequent to leaving Meltzer, Lippe, Goldstein & Schlissel, I also had no responsibility regarding the PCT patent application.

D. I deny the allegation that I failed to ensure that the relevant patent applications that I was asked to file contained all necessary and pertinent information relevant to the technologies as required by law. Mr. Bernstein had agreed that I would file provisional applications as his development progressed. Those applications were prepared and filed and included all information which was provided by Mr. Bernstein for each respective invention disclosure. Each and every one of the filed applications, provisional and non-provisional, which I was entrusted to file were duly filed and received by the United States Patent and Trademark Office. Each and every patent application accomplished its intended purpose, that is, to establish the respective earliest possible filing dates and/or

priority dates. Further, to the best of my knowledge, the legal sufficiency of these applications were never challenged or objected to by the United States Patent and Trademark Office. Mr. Bernstein fails to state any evidence to the contrary.

A search of public international patent records at <http://guest:guest@ipdl.wipo.int> was performed by myself on March 13, 2003. The search identified five (5) separate PCT applications filed in the name of Iviewit. These Iviewit PCT applications, apparently filed by Foley & Lardner's Office in Wisconsin, are listed below by their PCT application Number and filing date:

<u>PCT APPLICATION NUMBER</u>	<u>FILING DATE</u>
PCT/US00/21211	August 2, 2000
PCT/US00/15602	June 7, 2000
PCT/US00/15408	June 2, 2000
PCT/US00/15406	June 2, 2000
PCT/US00/15405	June 2, 2000

A copy of the search results page is attached hereto as Exhibit D. A text copy of each of the above PCT applications, identified respectively as Exhibits E through I are also attached hereto. The priority claims made in the PCT applications shows that priority was claimed to each of the Iviewit Provisional applications with the exception of the U.S. Provisional Patent Application Serial No. 60/125,824 filed on March 24, 1999. Priority for U.S. Provisional Patent Application Serial No. 60/125,824 was, however, claimed in the PCT application filed on or about March 24, 1999, which application was transferred to Foley & Lardner. In this regard, the provisional application filings served

their intended purposes as priority documents establishing the respective priority dates for the alleged inventions disclosed therein.

E. I deny the allegation that billing statements and transmitted documents were falsified. The Complaint fails to identify what alleged falsifications took place.

F. I deny the allegation that patent documents were falsified or that the contents thereof were changed prior to filing. No information in any of the Bernstein/Iviewit patent applications was ever changed or omitted from any patent application prior to filing after the document had been approved for filing by Bernstein/Iviewit. For each application filed, the same protocol was used, Mr. Bernstein, and/or Mr. Utley when he was a named inventor, provided information to me usually in a very short disclosure document which, if I recall correctly, consisted of a description of the technology and/or the enumerated processing steps. In some instances, additional information may have also been conveyed verbally in conferences or meetings with Mr. Bernstein and/or Mr. Utley. In each instance, I would generate a document to be filed with the U.S. Patent and Trademark Office and would provide same to Iviewit for review. I would await any comments and instructions for revisions. Thereafter, I would receive instructions to file the pertinent document, either as a provisional patent application, a non-provisional patent application, and/or a PCT application. After the pertinent application was filed, Mr. Bernstein was provided with a complete copy of all filed papers. Mr. Bernstein and/or Mr. Utley never informed me of any such alleged omissions or changes to any filed application.

Thomas J. Cahill, Esq.
April 8, 2003
Page No. 21

I also deny the allegation that I filed patents in my own name “that would succeed upon the Company’s patents failing,” and I further deny the allegation that any of my inventions or patent applications would appear to be ideas learned while representing Iviewit.

Iviewit’s technology and its alleged inventions were in the image data file compression and video data file compression technical art areas. I have never claimed to have invented and/or have never filed any patent application in my name for any inventions for or relating to any image data file compression or video data file compression technology or technologies. As I noted above, I have invented and patented inventions involving the transmission of video or images on or over a communication network or on or over the Internet and/or the World Wide Web. My inventions did not address image file compression or video file compression simply because such data file compression was not necessary in my inventions. Mr. Bernstein was made aware of some of my inventions and, in particular my 405 Patent, which he had knowledge of dating back to the summer of 1999. In any event, the Complaint fails to identify which of my patents or pending patent applications appear to be allegedly based on ideas learned while I represented Iviewit. I never appropriated any ideas learned from Iviewit or Mr. Bernstein at any time.

To the contrary, while preparing this letter, I discovered that Mr. Bernstein may have appropriated ideas contained in my 405 Patent as his own after he retained Foley & Lardner as Iviewit’s new patent counsel. For example, compare PCT/US00/15602

Thomas J. Cahill, Esq.
April 8, 2003
Page No. 22

application at page 1, lines 7-8 (Exhibit F), which states "The present invention [ALSO RELATES] to a system and method for controlling a video device over a network" and at Page 2, lines 3-30, with the subject matter of my 405 patent (Exhibit A) at Col. 1, lines 5-16, in Claims 1, 4, 6, 7, 12, 13, 14, 15, 16, 18, 19 and 20, at Cols. 74 thru 78, in Figures 5B and 11B and the descriptions relating thereto at Cols. 28 thru 29 and at Cols. 49 thru 50, respectively, at Cols. 12 thru 13, at Cols. 22 thru 24, at Cols. 52 thru 53, at Cols. 56 thru 57, and at Cols. 69 thru Col. 70.

Please also note the text of PCT/US00/15602 at Page 2, line 40 to Page 3, line 3 wherein the document states in pertinent part:

Compression and other manipulation of the video data is optional, since such manipulation typically results in decreased resolution and definition. Furthermore, saving compressed files of video data is not required to provide enhanced playback of video data to users over the network. [WHILE] the exemplary embodiments are explained with reference to video signals, it is understood that a video signal may include corresponding audio signals therein. Alternatively, the corresponding audio signals may be processed through a different method.

The Chief Counsel is respectfully requested to note the gist of the above statement, that compression is optional, and that audio can be provided along with video. Please refer to the 405 Patent and Figures 5B and 11B and the descriptions relating thereto at Cols. 28 thru 29 and at Cols. 49 thru 50, respectively, at Cols. 12 thru 13, at Cols. 22 thru 24, at Cols. 52 thru 53, at Cols. 56 thru 57, and at Cols. 69 thru 70.

Please also refer to Exhibit F at page 6, lines 32-35 and please compare this passage with the 405 patent (Exhibit A) at Col. 74, lines 33-44.

Thomas J. Cahill, Esq.
April 8, 2003
Page No. 23

For the sake of brevity, I will stop at the above examples, although numerous other examples of my technology and disclosure finding its way into PCT/US00/15602, filed June 7, 2000, can also be identified if necessary.

I respectfully submit that the above instances of the apparent copying of certain aspects of my 405 Patent, an issued United States Patent, and a published document which Mr. Bernstein knew about and told me he had reviewed on at least one occasion, provide unequivocal support for my position that it was not me who obtained ideas from Iviewit, but rather, it was Mr. Bernstein or some other Iviewit individual who obtained ideas from my issued 405 Patent and sought to file a patent for an invention which was disclosed by me in a United States Patent application filed almost four years earlier and patented and issued almost one year prior to the filing date of PCT/US00/15602. Further, Mr. Bernstein would now have the Chief Counsel believe that he or others at Iviewit invented technology which brings video and audio over the Internet or the World Wide Web and that he or others at Iviewit also invented the idea of controlling video cameras remotely via the Internet or the World Wide Web. My 405 Patent speaks for itself. Mr. Bernstein's claim is simply untenable.

G. I have no knowledge regarding Crossbow Ventures or any of its investment decisions with regard to Iviewit.

Lastly, I disagree that any of my actions resulted in a loss to Iviewit. Upon information and belief, Iviewit, according to its web site, has multiple patent applications pending in the United States and abroad. A copy of the pertinent web page is attached as

Thomas J. Cahill, Esq.
April 8, 2003
Page No. 24

Exhibit J. On further information and belief, Iviewit has exercised its rights pursuant to its PCT applications in filing three (3) European patent applications and what is believed to be five (5) Australian patent applications. A copy of a public records search attached as Exhibit K indicates that these applications have been filed. The status of these applications is unknown to me. Clearly, however, Iviewit does have patent counsel who appears to be actively representing Iviewit in various patent matters.

On March 25, 2003, Iviewit was selected as a new company to take part in the Epoch Incubator project sponsored by IBM, O'Melveny & Meyers, Deloitte & Touché, Silicon Valley Bank and Zone Ventures. A copy of this relevant press release is attached hereto as Exhibit L.

In view of the foregoing, I respectfully request that the Chief Counsel recommend that the Complaint be dismissed without referral. In the event that the Chief Counsel needs additional information, I will willingly comply by providing same. In the further event that additional information concerning me is given to the Chief Counsel, I respectfully request an opportunity to respond to that information before the Chief Counsel makes a recommendation in this matter.

Sincerely,

Raymond A. Joao

DEPARTMENTAL DISCIPLINARY COMMITTEE
SUPREME COURT, APPELLATE DIVISION
FIRST JUDICIAL DEPARTMENT
61 BROADWAY
NEW YORK, N.Y. 10006
(212) 401-0800
FAX: (212) 401-0810

PAUL J. CURRAN, Esq.
CHAIRMAN
HALIBURTON FALES, 2D., Esq.
HON. THOMAS B. GALLIGAN
MARTIN R. GOLD, Esq.
DENIS MCINERNEY, Esq.
ROY L. REARDON, Esq.
STEPHEN L. WEINER, Esq.
SPECIAL COUNSEL

LAWRENCE J. BANKS
SALLY W. BERG
DOUGLAS W. BRANDRUP, Esq.
CHRISTOPHER E. CHANG, Esq.
ANN J. CHARTERS
BRIAN M. COGAN, Esq.
DENIS F. CRONIN, Esq.
TELESFORO DEL VALLE JR., Esq.
CHARLES E. DORKEY III, Esq.
PAUL F. DOYLE, Esq.
JUSTIN E. DRISCOLL III, Esq.
PATRICIA FARREN, Esq.
MARION T. ETHEREDGE
STEVEN N. FEINMAN, Esq.
ROSALIND S. FINK, Esq.
CHARLOTTE MOSES FISCHMAN, Esq.
BEATRICE S. FRANK, Esq.
MARANDA E. FRITZ, Esq.
WILLIAM A. GALLINA, Esq.
ROBERT L. HAIG, Esq.
RICHARD J. HOLWELL, Esq.
SUSAN M. KARTEN, Esq.
JOHN J. KENNEY, Esq.
DAVID G. KEYKO, Esq.
MYRON KIRSCHBAUM, Esq.
LENORE KRAMER, Esq.
WILLIAM FRANCIS KUNTZ II, Esq.
MICHAEL A. LACHER, Esq.
DEBORAH E. LANS, Esq.
MARVIN LEFFLER
BURTON N. LIPSHIE, Esq.
HENRIETTA LYLE
MARY B. MAGUIRE
CHARLES C. MARINO
DOUGLASS B. MAYNARD, Esq.
LAWRENCE D. MCGOVERN, Esq.
CHARLES G. MOERDLER, Esq.
MATHIAS E. MONE, Esq.
MERCEDES A. NESFIELD
JANE W. PARVER, Esq.
ANTHONY M. RADICE, Esq.
ANDREW W. REGAN, Esq.
TIMOTHY G. REYNOLDS, Esq.
MICHAEL J. ROSENBERG
REUBEN SAMUEL, Esq.
AUGUSTIN J. SAN FILIPPO, Esq.
SAMUEL W. SEYMOUR, Esq.
DANIEL E. SIFF, Esq.
MARIAN E. SILBER, Esq.
EUGENE P. SOUTHER, Esq.
JOHN L. WARDEN, Esq.
ERIC J. WARNER, Esq.
SUSAN WELSHER
COMMITTEE MEMBERS

THOMAS J. CAHILL
CHIEF COUNSEL
SHERRY K. COHEN
FIRST DEPUTY CHIEF COUNSEL
ANDRAL N. BRATTON
DEPUTY CHIEF COUNSEL
CHRISTINE C. ANDERSON
ROBERTA N. BERKWITS
ANGELA CHRISTMAS
NICOLE CORRADO
JORGE DOPICO
MADY J. EDELSTEIN
JEREMY S. GARBER
NAOMI F. GOLDSTEIN
JOSEPH J. HESTER
JUN HWA LEE
VITALY LIPKANSKY
STEPHEN P. MCGOLDRICK
JAMES T. SHED
EILEEN J. SHIELDS
JUDITH N. STEIN
RAYMOND VALLEJO
LA TRISHA WILSON
STAFF COUNSEL

April 16, 2003

PERSONAL AND CONFIDENTIAL

Mr. Eliot I. Bernstein
IVIEWIT
10158 Stonehenge Circle
Boynton Beach, FL 33437

Re: Matter of Raymond A. Joao, Esq.
Docket No. 2003.0532

Dear Mr. Bernstein:

We are forwarding herewith an answer to your recent complaint against the above-named attorney. If you disagree with the attorney's statement, please write us, telling us specifically how and why; if you have any documents substantiating your points of disagreement, forward them to us. Also, please tell us what has happened in regard to this matter since the time you filed the complaint.

If we do not hear from you within twenty (20) days, we may conclude that you agree with the attorney's statement.

All inquiries concerning this matter should be addressed to Joseph G. Wigley, Legal Assistant.

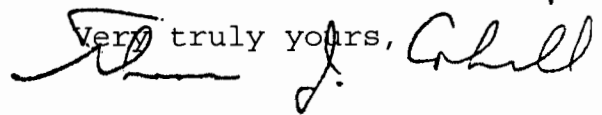
Very truly yours,

Thomas J. Cahill

TJC:adp/P:JGW/A:JNS
DC14 (F424/TB505)



Lorraine Christine Hoffman, Esq.
Assistant Staff Counsel
The Florida Bar
File No. 2003-51, 109(15C)

**Exhibit E – Foley and Lardner, Christopher Wheeler and Iviewit
Representatives Taped Transcripts 7/31/00**

CORRECTED VERSION - CORRECTED ON 5/14/2003
Transcription of Telephone Conference
Conducted July 31, 2000

Participants:

Simon Bernstein, Eliot Bernstein, Maurice Buchsbaum,
Brian Utley, Doug Boehm, Chris Wheeler

Note: Square brackets [] are used to indicate inaudible or indecipherable text. Text found inside brackets indicates transcriptionist's best guess. Since speaker names are not specifically identified, transcriptionist has made an attempt to identify based upon comments made in conversation but cannot guarantee that each speaker has been accurately identified. Note also that this recording has numerous instances of participants speaking at once or carrying on simultaneous side conversations that make it difficult to follow and transcribe the entire line of discussion.

Utley: <begins midstream>...status of the original digital image filings, and basically the fact that the original filings do not cover the full subject matter of the imaging technology; and to wit, one of the omissions, in particular in reading the claims section of the provisional and the formal filing, relates to the zooming and panning capability that is inherent in the technology. This has become a topic due to the fact that we are currently in the second phase of filing imaging patent protection which is driven by the provisionals that were filed later last year, between August and December of last year. So the concern that were expressed by Eliot in reviewing this is that this omission of the zooming and panning capability was attributable to a failure, for whatever reason, on the part of Ray Joao, the patent attorney of record, in constructing and putting together the provisional and formal filing<tape cuts out here> did I say it is that right Eliot

E Bernstein I believe so

Utley Is that your understanding

E Bernstein Correct

Utley The purpose of this meeting is to review the facts and I think there are two particular points that are ...that are important to moving ahead. The first is: "Given that the filings are what they are, and given what we know about the filing which is scheduled to take place this week on Wednesday, what means do we have to correct the situation; and given whatever corrections we find, what then is the impact or exposure to iviewit based upon what actions we can take. Then, lastly, what, if any, recourse might iviewit have vi sa vi the omissions in the original filings Are there any other issues, Doug?

Bernstein: Yeah, just correcting back to Ray Joao's work of the formal filing that he filed. Do we have a copy of that?

Utley: I do have that.

Bernstein: I don't. I've got the provisional and I've got...

Boehm: Everything is on the table

Utley: you should have...the formal.

Bernstein: This one?

Utley: Yes, that's the formal.

Bernstein: Okay.

Simon Bernstein: I just have one question. Does anybody have, or are we allowed to get, the files of Ray Joao?

Boehm: I have them.

Wheeler: Do you have all of the work that he had?

Bernstein: No, not all of it.

Utley: What was purported to be in the files?

Bernstein: And he also claimed to us that he destroyed part of his files.

Boehm: And I have some of his files. I have what was purported to be all of the firms' files.

<Inaudible comment.>

Utley: Well, there's a whole history, then, because I tried to get complete copies of the files originally, and found out later that not only did he not send us all the files, he didn't even mention that there was an extra filing out there that we didn't even know about.

Bernstein: This one that's in question.

Boehm: Yep

Simon Bernstein: You have no notes, no data on...?

Boehm: No, I have the application. I have things that you could get from the US patent office—that I could get from the US patent office. I have very few notes. I do have some scribbled Ray Joao's notes, but I think you gave me those notes.

Utley: I did. I gave you Bill Dick after Bill yourself[] the notes that I had.

Bernstein: And Ray's made disclosures to us that he destroyed the documents to protect us, which I don't know what he was thinking.

Simon Bernstein: Destroyed what documents?

Bernstein: Whatever he had in his files. Other patent copies, copies of the drafts as they proceeded...all that he destroyed to protect us from something I asked him to explain, and his reasoning...because I said to him, you know, usually you destroy documents when you are protecting somebody from something illegal or something. Have I done something that would force you to hurt me possibly? He said it was typical, normal, that all lawyers destroy their records.

Simon Bernstein: If that, in fact, is the case—I've never heard of a lawyer you know other than Nixon destroying anything the work is ours. Am I right Chris when we pay for a lawyer and we pay for the work, the work is ours.

Wheeler: The work product is yours. He may maintain copies of his files and everything; or his confidential notes to himself are not necessarily yours. But the work "product" is...

Simon Bernstein: Would you say that anything germane to the issue belongs to him?

Wheeler: Well, I mean if he wrote notes...in sidebars...yeah.

Bernstein: How about revised patents[]. How about copies? Works in progress

Wheeler: But things which would reinforce your patent, obviously, that is germane to the strength of your patent yes, you would be entitled to copies I don't think we disagree.

Bernstein: He's claiming He destroyed all faxes.

Wheeler: Can I ask you a question?

Bernstein: Yes.

Wheeler: Just so both of us understand...was this patent done prior to his flying down here, or was this patent done as a result of his flying down here and having discussions with you? I was under the impression that when he flew down here—this was before Brian came—I was under the impression that followed our meeting with Reel 3-D. I was under the impression that he was coming down to discuss, at the very least, the video aspect so that you could complete that; but were you also completing the imaging patent?

Bernstein: Correct.

Wheeler: So he went to your [kitchen]?

Bernstein: Right. And we spent days there

Wheeler: And the two of you spent all the days...

Bernstein: Correct.

Wheeler: And did he, in front of you, write notes?

Bernstein: Tons. Hundreds

Wheeler: And did he then produce them on his computer and type out certain things?

Bernstein: Yes.

Wheeler: I was under the impression he was doing that with you.

Bernstein: He did.

Wheeler: And did you read those?

Bernstein: I did. I did - now going to that same nature, that's the provisional I think we're talking about...

Wheeler: Right.

Bernstein: But he flew out here again with me and Brian and went through this as he went to file this--this is a 3/23/2000 file--that also fails to make mention of.

Wheeler: So that's the formal file...the formal one?

Bernstein: The formal file. So both also missed the point.

Wheeler: I just wanted to know and to put things in proportion, when you read the provisionals, because Brian wasn't with the company right now and then, and when there were all those drafts, because obviously we didn't see them...

Bernstein: Well, you saw because we gave you all the documents. I'd get a document from Ray and bring it to you so you would have records of everything up to that point because I didn't want to keep them at my house.

Wheeler: The final...the final...but I'm not reviewing the patent. I was keep maintaining it as...

Bernstein: Okay, but you have every record...

Wheeler: Everything you gave me we maintain. We don't...

Simon Bernstein: Any notes should be produced...

Wheeler: We don't throw away anything.

Bernstein: Yeah, I know.

Simon Bernstein: I know you don't you're very thorough.

Wheeler: So, I'd file it away; so if you gave it to me, it's in our archives.

Bernstein: Right.

Wheeler: I wanted to know, when you read those drafts...

Bernstein: Oh, it was...it was clear

Wheeler: Answer my question...when you read the drafts, did you see the panning and scanning elements?

Bernstein: Yeah, and zooming, up to 1,000 times we thought it was. That was the big...you know, we had it in there...as a matter of fact, he just said it...somewhere it's in there up to 1,000 times, isn't it?

Utley: 1,700.

Bernstein: Right. That was our old mistaken a number of times. So, yeah, for him to miss that, Chris, would be the essence of stupidity.

Wheeler: So it was in there?

Bernstein: Absolutely.

Utley: The zooming, it was in the body, but not in the claim.

Boehm: But a provisional doesn't really...doesn't have to have claims.

Utley: It doesn't have claims.

Bernstein: But then in our claims of our patent, it's not there. This is what you're representing, correct?

Wheeler: So you're saying that it wasn't put in the file, but it was put in the provisional.

Boehm: No, I could see where he's going to argue that it's there.

Bernstein: Let's see. Let's take a look.

Wheeler: ...what the language of the patent claims are that he filed.

Bernstein: Okay, let's see what he...

Wheeler: And this isn't the final decision because I can go back right now and amend those claims.

Bernstein: Wow, yes, but we have elements of exposure that creep in correct?

Wheeler: I'm just telling you the whole thing, then we'll go back. So you did look it over, and there are no claims in the provisional?

Boehm: There are no claims in a provisional. You can file them, but they are never examined.

Wheeler: But the zooming and the panning and the scanning element was incorporated in that?

Boehm: Go ahead, Brian.

Utley: Let me make sure that we say that properly. The provisional filing had a claims section which migrated into the final filing, but Eliot is correct in saying that the provisional does not need a claims section.

Boehm: The provisional never gets examined, so it doesn't need the claims. It just holds your place in line for one year.

Bernstein: But then when I look through this...

Simon Bernstein: Hold on, Eliot, I need to understand this. What you're saying, then, is assuming any negligence on his part, to that point the negligence doesn't become realistically damaging to the company until since he actually made a claim...since he actually made a provisional filing. Which took our place in line.

Boehm: If the provisional filing covered the invention, your place in line is only as good as the subject matter described in accordance with the law.

Simon: Obviously, it should have had the panning and zooming in there.

Boehm: Well, the word "zoom" is in there.

Bernstein: But not really to describe what we're doing.

Boehm: But do you see what I'm saying? It's only to the amount of subject matter that and attested where the average person skilled in the art could make and use an invention as it's described in this document, and without "undue" experimentation, without inventing it himself.

Simon Bernstein: Right.

Boehm: Now, this provisional application, you throw it...different patent attorneys do different things with it. On one end of the spectrum, you do an invention disclosure. Most big corporations have invention disclosure forms which leads the inventor to write out good disclosures and figures and things, and I've seen people actually file that invention disclosure because if you're coming up on a bar date, you don't have time to write an application or think about what your invention is. All you've got to do is get something on file, and then hope that it will protect...that whatever you had on file covered your invention.

Simon Bernstein: Is that what we've done so far?

Bernstein: No.

Boehm: I don't want to answer that, but that's the line.

Boehm: It's a grey question, it's a grey area, I think.

Wheeler: That's what we're aiming to do, that's what we're hoping to do.

Boehm: But on one end of the spectrum, you file very minimal work, and that's what Ray did on some of the applications, like on the one...

Wheeler: He was trying to do it in a broad...

Wheeler: He did say conceptually that his method was to do a broad stroke of it.

Boehm: Right. Well, a broad stroke on drafting the claims.

Wheeler: Okay. Right.

Eliot Bernstein: He's got to put the invention in!

Boehm: That doesn't happen in a provisional at all, generally. If you want to, you can write the provisional claims just so you know what you're doing, and it's actually used as subject matter; but the claims are never examined. It doesn't matter if it's in proper format or anything, it just sits there. Now, if you pick up the provisional a year later—it has to be within that year—if it's a real well done application, you just file it. There's no money involved in turning the provisional into a regular filing. Oftentimes, with these one-page disclosures, there's a substantial amount of money involved in taking that from there to there. The problem is you cannot add subject matter to the patent application later on once it's filed.

Bernstein: Unless it's really the patent application, correct?

Boehm: No, the subject matter has to be supported—has to be described—

Simon Bernstein: In the provisional.

Boehm: Uhhuh To that text, or you lose your filing date.

Wheeler: But the zooming element, then, is not in addition.

Boehm: Is not in addition? You mean...

E. Bernstein: It's not even in there.

Wheeler: You can't add subject matter. So if he did describe zooming, then it's not in addition.

Bernstein: Did he, ?

Wheeler: I am asking you whether he did or not?

Boehm: I'm not clear on what you mean. You can't add additional subject matter after the filing date of an application or you'll lose the right to that filing date.

Wheeler: The provisional? You can't add subject matter to the provisional?

Boehm: To any application...any patent.

Wheeler: But if he did describe the zooming, then the zooming element is not an addition in the formal.

Boehm: Right. It's supported. If he described it in the original, you can base claims on it later.

Wheeler: And have we said that the zooming is in the provisional?

Bernstein: Nowhere that I can see.

Simon Bernstein: Wait. You're the lawyer reading another lawyer's work. Is it in there?

Boehm: Do you have a copy of it?

Bernstein: Yeah, right here. It isn't in there if it bites you.

E. Bernstein: It's not in the filing either.

Simon Bernstein: It's obviously not in the filing if it's not in the provisional.

Bernstein: No.

Simon Bernstein: Can you make reference to something...let's say he uses the word "zoom".

Boehm: Exactly. I'm pretty sure the word "zoom" is in there, isn't it Eliot?

Bernstein: But what Doug's saying is that had you written the patent, you would have described the invention as the ability to do this cool zoom that we all...and just said this is the cool part of what we're doing. What Ray's missing in the outline is the ability for you to put a picture on a Web page.

Wheeler: He did know that an important element was the fact that when we went in and made it bigger, we didn't pixelate.

Bernstein: It didn't pixelate. Not in here at all.

E. Bernstein: Not even mention to that concept.

Bernstein: Complete failure. It's not.

Wheeler: But if said it doesn't distort when we zoom...

Bernstein: Nope. Nothing like that.

Wheeler: That's the same thing, isn't it?

Bernstein: Yeah, but he hasn't said anything...he doesn't even tell you ...

Wheeler: What about the panning element, or is that element not patentable?

Bernstein: No, that's part of the whole process is to be able to zoom while panning.

Wheeler: Here it is. "The above process can be utilized in order to create higher zoom capabilities with each new depth layer of an image..."

Bernstein: No, but that's a new depth layer which is bringing in another hotspot image, so it's really a completely different subject.

Boehm: Oh. Okay.

Boehm: Okay. Where is that?

E. Bernstein: I read it to, he's very crafty you know.

Boehm: "Where the zoom capacity of up to 1700 times or greater may be easily obtained with the [present conventions.]" Are they talking about the hotspot now?

Bernstein: No.

Boehm: No, it's the general zooming capability.

Wheeler: So it's not in addition.

Bernstein: Well, explain to him where it's missing.

Wheeler: You guys didn't put it in the formal...I don't mean you...he didn't put it in the formal one in the depth in that what we want to do it but he could have without it being construed as an addition.

Boehm: Yes.

Boehm: Well play lawyer on you now<Laughs; cannot understand his comment.>

Wheeler: Right - sorry

Boehm: Whether or not it's supported is a question that's going to be determined either between you and the examiner...probably not, it's between you and another

lawyer someday when the case is litigated. The question is And again, the test is: Can the average person skilled in the art—the average designer of this type of software—can he read this document and make and use of your invention without inventing it? That's the test. Now, whether he uses the word "zoom" in here and "magnification" later, that doesn't mater as long as he would have gotten it. If it is so simple to build by reading this, you don't need any subject matter. If you're combining three elements A, B, and C, and A, B, and C are standard in the art, and you tell them these are standard in the art, go combine A, B, and C, that could be a one-page application. The average person will pick it up and he could. It's a patent test. Are you with me? The more complex it is, the more you want it supported in this text.

Simon Bernstein: What if it is basically simple, and he just wrote it as basically simple, does that support our position anyway though?

Boehm: Does that support our...Sure...

Simon Bernstein: I mean, if we were to litigate against another person that infringes on our...

Boehm: An infringer.

Simon Bernstein: Supportable for the sake of argument?

Boehm: Right. Yes. That is a fair argument

Simon Bernstein: OK so then I don't know that, at least from first blush

Bernstein: That's the provisional you're reading though, right?

Boehm: Aren't they the same? I think they're identical, aren't they?

Boehm: You can check in his notebook.

Boehm: Are there differences?

Bernstein: Where did you find that piece that you just read?

Wheeler: Is the reason...now continue answering my question...is the reason we came to the formal in March of this year, which I didn't realize that Joao. I thought that we had agreements for doing everything, but apparently Joao filed...

Boehm: For that one, yes.

Wheeler: But he didn't bother telling anybody.

Boehm: That's the one that we didn't find out until way late.

Wheeler: Okay, perhaps the reason that he did that was that was the easiest way to do it and the course of least resistance, and he thought he could go back...is there an amendment procedure?

Boehm: Yeah, there's an amendment procedure.

Wheeler: That he could do it a few months later or something like that?

Utley: We had a conversation before the formal filing, and, in fact, I have my notes here from that conversation.

Wheeler: Okay.

Bernstein: And you mentioned that there was no zoom.

Utley: Yeah, I said...

Bernstein: Claim one.

Utley: Yeah, Here are my notes. This is my original copy. Claims do not reference stitching. The patent app does not cover providing enhanced digital image with zoom and pan controls. It covers for creating enhanced images to show zoom and pan functionality without distortion." Those are my notes.

Bernstein: And you told him that.

Simon Bernstein: Here's a man that was cognizant of what was necessary to be in there. How did a guy to file a patent without any of us—obviously, not me, but Eliot, Brian.?

Boehm: Jim wasn't around yet.

Simon Bernstein: Okay, but Chris was and so on and so forth—how did they get through the crack that he did this?

Wheeler: It didn't get through the crack. Brian addressed it with him.

Bernstein: And everything is shredded now, too. Everything else is shredded.

Utley: Kind of what he was going to do—his time factor—he was going to...he didn't think he would get this in. He would submit it and then would turn right around and amend it.

Boehm: Did he really say that?

Bernstein: Yeah.

Utley: I wouldn't say amended, it was because of the stuff that was coming...

Bernstein: It was supposed to be in there.

Utley: ...he was going to smash that all together and file it.

Simon Bernstein: Was that the same time, Brian, that he was leaving the firm?

Bernstein: Yeah.

Simon Bernstein: So would you say that probably...

Utley: he knew at the time that he probably would be leaving?

Utley: Right.

Simon: But he wanted to get all of this in place so he could do the billing and get that part of it in...

Utley: I don't know that.

Boehm: Just speculating.

Eliot Bernstein: What day did you give him those notes?

Simon Bernstein: I don't ever have to speculate on billing

Utley: I don't have my address book with me...I didn't write the date down, but it was the date that he was here. He came.

Wheeler: He wanted to get it done to take care of you, make sure it was filed for you.

Simon Bernstein: That could be too. One other reason is...

Wheeler: We're just speculating.

Wheeler: And I'm not trying to... <Everyone talking at once.> I thought he was trying to work on our best behalf, but one time or two times that I met him, it seems like he was earnestly trying to help. Who knows? Maybe he was incompetent. I mean we're only suggesting that it would have been incompetence

Bernstein: Well, the fact that it's not in your patents, right up front, this is the invention, is a gross neglect. And the fact that it doesn't say, "this is what the invention is trying to do. This is the feature..."

Simon Bernstein: The point is not whether it's gross neglect or not, it's what the damage is if there is...if, one, gross neglect is of any import; and two, what is the damage? it has caused iviewit. That's what I think we need to ascertain here, and if we can ascertain it.

Utley: How do we fix it?

Simon Bernstein: Of course lets try to fix it, if we can't fix it then we'll worry about...

Eliot Bernstein: Well 1st lets fix it

<Everyone talking at once.>

Boehm: Let me go over the procedures so everybody's clear. Again, on one end of the spectrum you file a very sparse, like a one-page provisional application, and it's cheap, and the purpose of the provisional is to get you in line...it is to protect your date. What you're trying to do is get the benefit of your priority date. When you invented it. When you're in line in terms of whose the next guy that invented it. Whose the first inventor?

Simon Bernstein: Someone comes after you the second day after...

Boehm: Who's the first inventor, that's what you're after.

Simon: I understand. I really understand...you don't physically stand...

Boehm: Not physically in line in the patent office is right, not or even in physically in line in order as well. Okay. One-year letter, the provisional expires and you have to file a non-provisional patent application, okay? Many times it's identical. If you do a good job up front, you just file that, but you need to put claims on at this time. When I do a provisional, I try, if there is money and time up front, to do it once up front. I even write the claims. As a matter of fact, I don't even like to file provisionals because there's not much of an advantage. If you've got the time and the money up front to do a good job, well then, just file it as a regular application.

Simon: Understand that at the beginning, the time and the money...I mean, the time was certainly available, but the money was a short substance. So it was obvious that Ray would be working in a most expeditious way.

Boehm: Well, that's why the..

Simon: Which might have short-circuited us because of all of the lack of funds.

Wheeler: Well, that's true because the filing date is 3/24/99 to endorse that...that was very early in the game.

Simon: We did it in your office Chris in your library...in your conference room. The only meeting I had with him was while we were going to file the patent and that was in your office.

Boehm: Okay, 3/24/99 is the provisional application.

Bernstein: That's what I'm saying. Well, Chris,

Boehm: So even at a year, he filed the second one with claims.

Buchsbaum: Yeah two things happened during the year. One, the Company was doing other things, even though they knew that was coming up, and two, I guess there wasn't a whole lot of money to allocate towards doing that much.

Simon: Here's what we did. We hired Ray Joao on the monies that were raised by the investors; and then when Huizenga was coming in with their money, and when that money came in, we made a company decision that the first and foremost thing was to get the patent filed properly. So the fact that we were going to spend more money and get them completed at that point had already been made.

Simon: Okay, but prior to that, we were working on short forms. Then after that, we started to raise capital, and we always knew that the priority was intellectual property, so were going to make sure that those got done right. Brian's been working on it ever since, and I felt comfortable...I never did feel comfortable with Ray Joao...just an observation.

Boehm: Hmmm...is it all patent attorneys? <Laughter>

Simon: No, no, there's nothing wrong. He came in, he's a nice guy, he tried hard, you know, all the nice things, but his work always appeared sloppy, okay? And that's the only thing I can say. You're a patent attorney, you see what he did. If I'm wrong, then let me know; but to me, it looked like it was a little slipshod. And then he made some statements that really bothered me, too, that I don't think he should have made to a client, and that is that he was filing his own patent. <Chuckling.> I mean, horseshit personally, I haven't heard of a patent attorney in my life telling me that he's an inventor filing his own patent. It really did bother me.

<Everyone talking at once.>

Bernstein: Transmitting video files on a communication network for airlines and...

Simon: It probably meant nothing because I don't think the guy was of the nature to be stealing from us, but I don't know! But I'll tell you this, it did ring a bell. From a pure novice, it made me a little nervous. I asked Eliot why he was dealing with somebody, but we were assured that this was a good firm...

Boehm: Let me look back in my own spiel...here with the provisional. You file a provisional, then within one year, you file a regular application with the claims. You can add claims to it; but if you add subject matter to it—in other words, if the zoom and pan concept wasn't well described, you have lost the benefit of that first phase. Right. Now

why is that going to hurt you? Two main reasons. One is if you put it on sale—offered it for sale— or you publicly disclosed it, there are certain regulations that say you've got to get something on file, so if you had publicly disclosed it, that would protect...getting the application on file will protect you from losing your date because of public disclosure and offer for sale. I think that's what he was trying to get the earlier dates for.

Simon: Sure.

Boehm: I spoke with Ray when I was trying to get all of these files, and his comments to me were...when we were on the phone—you remember, we were asking him where was this stuff, and he said, well, he kept building on and he learned more it got in there. After I reviewed these applications, I agree that you're learning more as you go along. I'm doing the same thing. So it's kind of a learning curve.

Bernstein: If they ever find a zoom description that adequately makes...especially in the claims...I mean, if you're reading the claims...

Boehm: But Eliot, he's going to say that the claims are of no import right now. All you have to do...

Bernstein: In the filings?

Boehm: In the filings. I can go amend those right now. We can sit down today and re-write them.

Simon: If it can be amended amend it. There's no problems.

Boehm: There's no problems.

Simon Bernstein: There's always maybe a little money that's been duplicated and that's it.

Boehm: Here's the problem, and that's what I want to get across about that. If he's trying to claim zoom and pan and I rewrite the claims to claim zoom and pan, and the examiner says, that's great, but it's new matter

Bernstein: But it's in the provisional that you can zoom up to 1700 times.

Boehm: If my claim is supported by the spec on that date, then you're fine.

Bernstein: Isn't it?

Boehm: I can't answer that without going into the...

Bernstein: But when we read the provisional and we see that, it says...

Simon Bernstein: Before this meeting took place, before we called this meeting, aren't you privy to everything that's been done?

Boehm: Oh, sure. I have everything.

Simon Bernstein: So when Eliot asked you that question, why can't you answer it?

Boehm: Because there's no...in my opinion, there's no clear-cut answer, yes or no, on the quality of the work product. It's a judgment call.

Bernstein: So that's an exposure, and what if the judgment is against us?

Wheeler: It's [an examiner] judgment call is what we're saying.

Boehm: The damage?

Wheeler: No, the examiner. <Everyone talking at once.>

Wheeler: Whether the subject matter is new or not.

Boehm: The examiner would...hold on...it's...

Wheeler: whose judgment call is it?

Boehm: It could be the examiner's, if he catches it. If it's not caught, and you get it to patent and you litigate the patent, ... at court. Or if the examiner catches it and I want to appeal it to the board of appeals in the patent office, it's their judgment call

Wheeler: Okay, so we go to court and we're fighting over the patent, we would argue that it's supported by the zoom 1700 in our language, and the other side would, say that's baloney that's too broad you didn't describe it enough

Boehm: You didn't have your invention...

Bernstein: Then you lose.

Boehm: We would lose only if you had a bar date come in there if somebody else invented before you, or if you put something on sale...or if we offered something up for sale.

Bernstein: Which we did.

Boehm: But the offer-for-sale date from our first meeting is not until September.

Bernstein: Right.

Boehm: So the offers for sale won't normally kick off a foreign...

Simon Bernstein: Could you explain to me what offer for sale means?

Boehm: Sure. As soon as you...you can't get a patent on a product after you've been using it for more than a year. As soon as you publicly disclose your invention, you've got one year in the United States to get a patent on file, okay? Even if you don't publicly disclose it...let's say I've got a method of making [] in my factory, but it never gets outside. I'm starting to commercialize it, I'm making money off my invention...the commercialization date a year later is you can't patent it in the U.S. So that's that one-year grace period.

Simon Bernstein: Aren't we within that period?

Boehm: Yes. As far as we know, yeah. As far as we know.

Utley: Yes-yes we are within that grace period

Simon: Okay, somebody explain to me, what am I doing here? Why am I sitting here? Are we saying that Ray Joao, other than being sloppy, but there's not much damage that could have been done or can be done because we can fix it, which really would make me the happiest to hear that.

[not in transcript: PSL look at change above although minor it indicates perhaps the change in text to match new text]

Utley: Can I jump in? Let's just say there are two steps. We're going to make a filing this week; and to the best of our knowledge, we have swept up all this in this filing, and that will be within the commercialization period. The second thing that we're going to do is we're going to look at filing an addendum to the original formal filing to strengthen the claims - broaden the claims ... to the maximum extent that we can.

Boehm: if we need it...if we need it.

Boehm: It'll be a lot of this was swept up into the application.

Utley: What we're trying to do is protect the date day of March 24

Boehm: The original...

Utley: The original date as March the 24th, but filing should remain an objective.

Simon Bernstein: Brian, if you broadened the language now, would that be a red flag to the commissioner that you should have done it earlier? Or should we just say that this has always been there?

Buchsbaum: You mean the examiner of the commission

Bernstein: We're not going to be able to say it was in the claim.

Simon Bernstein: What happens when you start those amendments or broaden them is you start to admit that you didn't do it.

Boehm: Um, yes and no. We...I do that all the time.

Simon Bernstein: It's common then?

Bernstein: If they do it all the time, then we have to do it.

Simon Bernstein: But not until I feel more comfortable with it.

Boehm: We normally have a search done. The patent examiner will do a patentability search, and he will come back and reject it. The problem is if the claims are too narrow to begin with, he will not come back and reject it, he'll allow it, and boom! Now I can't amend it he's in. [], we're done. But I can file an continuation on it. I can keep dragging this out and get broader claims as long as the subject matter is...

Wheeler: So that's why he stated it broadly versus narrowly?

Boehm: No.

<Somebody comes into the room to take food/and or drink orders.>

Boehm: No, but as far as, doing it broadly, if you're saying to claim it broadly it's our job to claim... as prior art which I doubt the claim is as broad as the [] allows...

Wheeler: Right. That's what I'm saying.

Boehm: And this is claimed broadly.

Wheeler: Right.

Boehm: And that's the normal tactic, to claim things broadly, and then wait for the examiner to come back and say, "Oh, you can't get it that broad," and then narrow down your claim.

Wheeler: Okay, so isn't that what he was in part trying to do? That's what he's been saying, yeah.

Boehm: Yeah.

Wheeler: Well, would that not be consistent with how patent attorneys try to do things?

Bernstein: Well, claim one, if you look at their claim one, Chris, that they've written, it identifies...

Wheeler: Who's they?

Bernstein: Foley & Lardner. It identifies what you're trying to do. [not in transcript: Stephen note how Dicks name is deleted and Foley's name is screwed up, may indicate who was changing this transcript]

Wheeler: Okay, so maybe it should have been written differently.

Boehm: You won't get two patent attorneys to write the same claims.

Bernstein: Well, no, but you try to write the claim, and that's the teaching you and Steve both represented us here, to describe in its broadest term...

Boehm: Right.

Bernstein: ...the invention.

Boehm: Well, I can't say that this isn't broad. This is very broad. This might be rejected for indefiniteness...I don't know what it is...but now he's got the opportunity to go back and...

Bernstein: And Brian, you know, there's print film image in here, it's all supposed to be out of here.

Wheeler: What you're telling me is that in your forum of law there's always going back and refining and refining and refining that was wrong.
<Everyone talking at once; two different conversations going on at once.>

Bernstein: This is like he just completely ignored what we said over a year. He didn't do a thing. Nothing. No comments, nothing.

Utley: Almost nothing between the provisional and the formal process.

Boehm: And some people intentionally file narrow just to get something on file. Then they can come back and repair it without damage to it.

Bernstein: But you don't know that because an examiner...

Simon Bernstein: You'll never know that until you have a litigation.

Bernstein: And then the question is what potential damage does that...

Simon: That damage potential and that remedy will be then taking place at that time, not now.

Boehm: That I agree with. Even if we decide something now, you won't know what the outcome is for five and a half months.

Simon Bernstein: ...wouldn't happen anyway. You wouldn't even know that.

Utley: Let me come back where I was. We are going to file on the 7th, Wednesday. As far as we know, that will cover every element of this invention that we have our arms around at this point in time.

Boehm: I believe so, yes.

Utley: And we should go back and address what amendments we can make to the claims in the filing of March this year and determine within the spec of the filing how broad those claims can be. I mean, that's going to be the test. Within the spec of that filing, how much leverage have we got to broaden those claims so that we do have a priority date which is back about a year ago last March.

Bernstein: So we want to insert everything going into this one into that one?

Utley: No, it'll be...

Utley: It'll be based upon the preamble, if you will, of what's in here.

Boehm: We do reference it. As a matter of fact, this is the cover page, Brian, of the application we're going to file.

Utley: Yeah, you reference it right there.

Bernstein: But you can add claims to that one that you're referencing that would encompass what we have in today's filing, which is really...we do want it in there.

Boehm: Yes, I can claims to the zoom and pan to get you back to the original date in this one since I claim to this onto his.

Bernstein: Well, we should do both.

Boehm: Well, you can't get two patents on the same invention, so it depends on where we want to go.

Bernstein: Well, we want to definitely get it in on his because it gets us an earlier date. Correct?

Boehm: No. It's a mess with these dates. What will happen is...nobody will worry about the date unless there's an occurrence, and that occurrence might... it's a major problem. You won't find out about that occurrence until you sue somebody, and then they go search in Australia, and they find a reference that somebody's done this before in the library, and then you worry about the date. Were you before him?

Bernstein: Well, that's what I'm worried about. I'd like to go back to our earliest date.

Wheeler: Can I point out one other thing? I know we look for the word...Eliot looks for the word...I know we look for the word "zoom," but there's also other language in here too. Sometimes we get caught up in a word "zoom," when what is zooming other than enlarging or reducing? And he does have language in here, "when enlarged or reduced, these pixels of the digital image becoming distorted a feature which

typically results in the digital image being fixed to an original size or being available at low magnification, such as, for example, magnification from 200 to 300 times. These digital images are also difficult to enlarge to a full screen without a tremendous amount of distortion present in the end product."

Wheeler: I mean, he's describing I mean that's zooming. Reducing and enlarging is zooming.

Bernstein: But he's not putting it in your claims, that's what he's saying. You see, this is different.

Boehm: But it doesn't matter right now

Wheeler: But it doesn't have to be if you've made mention. The opinion is that it doesn't have to be as long as he's ...if you made mention...if you've gone on record of having described this

Boehm: This is the background that's...problem. He's got...

Boehm: That kind of invention, right, it's got to state...

Wheeler: Well, I didn't get to that either.

Bernstein: Right. And that's where it's not.

Boehm: I pointed out a couple of things. It's not as...

Bernstein: Within the claims, the claims I'm reading, you could not...

Boehm: The claims really don't matter.

Bernstein: In the patent?

Boehm: The patent claims on a pending application basically don't matter.

Bernstein: No, the ones he filed.

Boehm: Yeah, they basically don't matter. I can go back and change them.

Bernstein: Okay. Why? So we want to change back to the original one he's filed, put as much language as we can that we have today...oh, it's all supported. Everything you wrote in that new one is supported in this one because it's the same process.

Boehm: That's the ultimate problem that Steve and I—Steve is Becker, the other patent attorney that actually wrote these patents <in audible>—but that's the ultimate problem that we're worried about, and that's the problem that you always worry about unless you first of all have a handle on the invention, inside and outside, and second of all, unless you really have a handle on Prior Art so you know where you

want to go with this. Then you spend the time and the money to do a good original provisional filing. You've got a pretty good shot that it's supported then. But when you file as, oh, I've got to try and cover this base, and when you do this kind of stuff, there's always going to be a question of what was supported when.

Bernstein: But that's fine. It is supported.

Simon Bernstein: We're off the subject matter.

Bernstein: So we should definitely claim back to the earlier date?

Boehm: We may get a rejection, or you may find out in litigation five years from now, that none of this was supported. Some court may say that you never talked how to do this because your software wasn't in the patent application.

Bernstein: It is, though.

Boehm: Well, the code isn't. They might say that these broad diagrams and these flowcharts aren't good enough. There's always that risk.

Bernstein: But we're trying to say that if they accept it, we want it to be to the furthest filing date that we can, which is March 3, 2000, and that's where it should lie; and if it's going to get argued let it live or die at that date.

Boehm: That's what we're trying to do right now.

Bernstein: Okay, good. So I'm under the impression from this point that we're going to encompass what we've learned what we're filing even in this other one even into the original one so we can claim back to a March 3 filing date that claims back to our original March patent...

Boehm: March 24th, yeah, all of that will go back toward what is supported in here, in the original. Not supported in ours.

Bernstein: Okay. And it's all going to be supportable because you're going to be able to pull up an image of the nature that we are discussing, and anybody with an eye can see that you've now done this.

Boehm: <Inaudible comment.>

Bernstein: Well, you're going to be able to show your invention, aren't you?

Boehm: No, no.

Bernstein: You can't?

Boehm: You live or die on what's in the specs. That's why...

Bernstein: Then get it in there.

Boehm: Yeah.

Bernstein: You can't bring it in as evidence what the invention is?

Boehm: Only outside evidence of what the average level of skill in the art is, okay? If somebody says that the flowchart isn't detailed enough, I'm going to go, "Oh, yes it is. Here's 29 programmers who are going to testify and say yeah, I can do that in my sleep with this document." So, there's always going to be a battle about the level of support.

Simon: Maurice and I—that's why I asked him to come in—Maurice and I were talking because neither one of us understands patents or how you file them or invention actually. What we do understand a little bit about is the theory in business; and now that we know that Ray Joao was somewhat sloppy—I'm not suggesting that he's not a fine attorney or anything else—you have been...you have reviewed all these patents that we have, whether there are eight or ten of them...

Boehm: There were eight original filings, and then...eight original filings.

Utley: Okay. And then how many do we have now?

Boehm: Let's look at the chart right now, but it's basically. We've got 17 applications that have been filed. These old ones are dead now because they were provisionals, and we've basically covered all...we pointed out basically covering two, maybe three inventions, so there's not...I mean, if we were to start over, maybe you'd do this with two patents, maybe one patent. So.

Simon Bernstein: Who owns them?

Boehm: Who owns it? iviewit Holdings, Inc.

Utley: Owns all of them?

Boehm: Except for...<Pause, and then text comes in that doesn't seem to be answering this open question.>

? Video playback over a network

Wheeler: How did he get in? [not in transcript but this refers to Jeff Friedstein on an invention]

Bernstein: He's part of the invention.

Boehm: An inventor - inventorship.

Boehm: So I've so I've got a document right here for him to sign. If he signs, then I do a couple of things.

Bernstein: He signed that when you faxed it to him originally.

Wheeler: I have copies of each one of these. Can I get a copy of your []?

Boehm: of this? Sure.

Wheeler: I have a copy of each one of these, I believe, or most of them...

Buchsbaum: Can I ask you a question? Your saying everybody that has an obligation to sign is on the list of names in these patents?

Boehm: You preferably don't...well, unless you have the new ones...

Wheeler: I don't have the new ones, but...

Bernstein: That's an old one. That's old.

Buchsbaum: You're saying everybody that has an obligation to sign is on the list of names in these patents right, because the company was part because the Company was doing, is that what you're saying? Because I don't even know if everybody has signed because you may due corporate due diligence for financial reasons or if...and they will say has everybody signed off on these patents, and if three people don't...if one person hasn't, he has an obligation to sign?

Boehm: Brian, have you signed?

Buchsbaum: Has everybody signed off on these? Brian?

Boehm: See these tabs [refers to tabs for inventors Bernstein, Shirajee, Friedstein and Rosario to sign] right here? That's what I'm trying to do today. As soon as...I'm going to have people sign, me sign...all the inventors sign. I've got to get a hold of Jeff

Bernstein: I thought we did that when we filed.

Boehm: You only signed one real document, didn't you? Did you actually a declaration? I know you didn't sign an assignment over but you're real clean on it because these are all based on the original filing , which is assigned to iviewit holding already

Bernstein: What's that mean?

Boehm: So all of the other inventors would have a helluva problem trying to say they owned anything.

Simon: Again, this is a little off the subject matter, but I have asked Chris about it before. If something were to happen to iviewit, and it were it went into bankruptcy, what would happen to those patents? How would those patents []?

Wheeler: It depends on which at iviewit you're talking about.

Simon Bernstein: The one that they are held in.

Wheeler: Well, first of all, holdings is held separately versus...we're operating the company out of a separate entity, correct? iviewit.com. So, let me think there...

Buchsbaum: The operating company is iviewit.com.

Simon Bernstein: All I'm concerned about is, for example, that the largest creditor...it wouldn't be a creditor, it would actually be an investor...would then...

Bernstein: They're not a creditor.

Buchsbaum: Okay, then the largest creditor could come in and pierce the corporate veil of iviewit.com and say that this is just a way of protecting the only valuable asset of the company away from creditors. Is there a possibility of that?

Boehm: Obviously there is.

Wheeler: There is a possibility, but that's one of the main reasons... But the loan, they made the company who wrote the patent, join in as a guarantor anyway on it.

Bernstein: Well, that would be all of us. All of those would be all of the investors getting a piece back?

Wheeler: No, no, no. On the \$800,000 loan, those people, it's secured by the patent.

Simon Bernstein: What about the \$600,000...or the other \$800,000 loan?

Wheeler: The others weren't loans. The others were equity, as I recall.

Simon Bernstein: No, no, they have claims.

Bernstein: Well, they're supposed to be converted to equity, which is another issue.

Utley: But there where note holders

Wheeler: No, because there was no quid pro quo at that time. The note holders I mean you can't go back and do it, we had that talk Si

Wheeler: I mean, you can't go back...

Bernstein: The note? I believe they're not final, even though we told people they would be by this time.

Wheeler: The note holders took their money in without taking security. Now you...<Indecipherable. Everyone talking at once.> ...new considerations...I said now you can't ... back to a failure to the corporation

Simon Bernstein: ...Board if everybody that was a creditor found, everybody that was a note holder at that point there was no what would you call it - problem

Buchsbaum: and that would be protected by the courts anyway usually. The court would see this probably as a you know a fraud

Wheeler: You could have two frauds: fraud of creditors and fraud of shareholders.

Simon: No, Chris I'm not worried about fraud. I'm really concerned with the fact that what we did here, the last loan that we took in, from...

Bernstein: Crossbow.

Simon: No, not from Crossbar...

Bernstein: Crossbow.

Wheeler: Crossbow

Simon: ...is secured by the...

Wheeler: ...the term of the deal, right.

Simon: And that's perfectly acceptable to me except that everybody else that had loans prior to that at that time should have been considered with the same equity because ...posses able and Chris told me that that was the perfect time to get it done

Bernstein: Yeah, but would Huizenga lose his?

Bernstein: Would Huizenga lose his stake in it to Crossbow?

Wheeler: No, no, no, it wasn't...I said that if there was going to be new considerations from those people, we all could of...??

Simon: We all could have put in another \$10. I mean, at the time we did it with Crossbow, we should have made sure that our other people...

Bernstein: Are protected.

Utley: No, no, no. We would have had to issue new contracts out for everyone.

Wheeler: There would have had to have been some material consideration, not just \$10. It would have been...

Simon: So it would have been \$10,000...

Wheeler: Well, then, you could have...Crossbow, we didn't even talk about Crossbow at that moment, and I said you couldn't go back and just collateralize. You couldn't go back for money that you already put in. But if you put in new

considerations that you could demand as a condition to be collateral.

Simon: What we should have done, or what we maybe we still should do to protect our original group of investors, is to have them pony up a few more thousand or whatever you think is legitimate, and amend the contracts to protect them as well.

Utley: That's new subject matter.

Simon: Well, I only brought it up because it had to do with the patents.

Utley: I know but can we finish the patent discussions before we bring up new subject matter.

Simon: You can, but I want to make sure that we do finish.

Utley: No, I agree with you Si.

Si: The problem is that I made claims to certain people like Don Kane, who put up \$100,000, who thinks...

Bernstein: Let's get back to that. No, let's get back to it. It's a definite point. There are people.

Buchsbaum: This is a business issue for later.

Bernstein: No, we're asked by these very people these questions.

Boehm: Did you get your question answered on the...

Buchsbaum: Yeah, I just wanted to understand...you know, I got an answer. It had to do with the obligations Si I was trying to understand if somebody does due diligence now with regards to understanding what is there and what has to be done, like those yellow tabs. [Yellow tabs indicate signatures of missing inventors]

Boehm: Yeah, but after...I find everybody, we can get guys to sign.

Buchsbaum: We aren't that many. I don't know on that sheet what you have, but I don't think there are that many names. There's what about five names?

Buchsbaum: There aren't that many...you don't have that many. I don't know on that sheet you have, I don't think there's that many names.

Boehm: No, there's not.

Boehm: So we have everybody but Jeff, if we can get Jude and Zak.

Buchsbaum: You just have to get people around and sign.

Boehm: No, that should not be and issue.

Buchsbaum: That might be questions brought up when people do do due diligence. Is everybody else on these?

Bernstein: That's why we're closing it. Right?

Boehm: We'll record what was in the patent office(...???) can do.

Utley: The other piece that's not in any part of the original filings, which is the reduction of the technology to a disciplined process—the mathematical representations of what's in and how it works and stuff like that.

Wheeler: (...???)

Buchsbaum: That will also be included in there, right?

Utley: We'll put it in the new filing...one of the new filings.

Wheeler: I form my opinion of everything, and we can talk about post solutions but I think Brian wants to get this back on track, but to me there's bad news and there's good news in this. The bad news is, just like anything in life, perhaps we would have liked to have tidied up some things better, like to have had Mr. Joao tidy them up. The good news is considering the state that the corporation was in in the early stages and the variable limited resources that it had, I'm glad that we have an awful lot on record that we do have on record, to be honest with you.

Simon: As long as it's not to the detriment of what we thought we were filing, I have no...I couldn't agree with you more.

Wheeler: But I think I like your approach, and I assume it's your approach, too, in that I assume that you're doing a fairly comprehensive new one, but then you're going to probably...

Utley: Claim priority back to the old one.

Wheeler: Right, but you're also going to do your amendment because now we're finding out that it's not an uncommon procedure and it's not a red flag.

Utley: Two things: the new filing on Wednesday will claim priority all the way back for as much as possible back to March 24th last year. Second, we will look at the March 24th year 2000 filing and determine how we should amend that to include additional claims and broaden that filing so that it more fully represents the knowledge of the invention as of that time.

Bernstein: Does it claim all the way back?

Wheeler: It'll go all the way back...

Boehm: as long as you don't go outside what was described.

Bernstein: No, the math is just describing the original invention.

Boehm: We'll, I'll never know the answer to that until it's litigated.

Utley: Due diligence.

Bernstein: Right, but from your perspective here, that's what we're setting up. Correct?

Boehm: We're going to try.

Bernstein: Okay.

Boehm: The question never even gets answered half the time in the real world. I will claim priority back on the document, and then if the examiner doesn't care, nobody cares

Bernstein: It gets through.

Boehm: It gets through.

Wheeler: Would it be a fair assessment—I'm posing this more as a novice, not as an attorney here—since we're not at IBM and we don't sit down at the very beginning and work out all these equations and all that, that in an invention such as this by a Ma-and-Pa type of inventor, and now since we're getting into the nuts and bolts and really uncovering, in essence, what's behind it, as Brian dissected it as we moved along, but that's all we're doing? I mean, that Ma-and-Pa inventors do that as they go along? They add the flesh to the bones as they go along?

Boehm: Boy, that happens, and we try not...we try to minimize the amount because if the flesh that you have to add is new subject matter and you've already sold your invention a year ago, you're dead.

Wheeler: Well no, Let me at it a different way. It does this, but I can't describe how it does this. But now we find out...we tell you what it does, now we're telling you in detail how it does it.

Boehm: Yeah, in terms of we claimed it properly.

Wheeler: So I'm not adding flesh in defense...

Simon: New flesh.

Wheeler: ...new flesh. I've got the box, now I'm disclosing what's in the box including the gears and how it works.

Bernstein: No.

Utley: No. Here's what the big difference is. The original filing claims a process for print film imaging.

Bernstein: Well, that was all stricken, by the way. That's why I'm having a big problem. I was going to get to that next, Brian.

Utley: Okay, good.

Bernstein: But we have discussed with Ray Joao numerous times to take out the references to print images out of this right here. Over the course of the year in the 59,000 modifications back and forth, we continuously pushed him away from the words that I see in this filing, and that's what's so disturbing to me because we sat here when...

<End Side 1; begin Side 2>

Buchsbaum: That would be conditional, probably.

Simon: Right, they probably will.

Wheeler: Their not going to want in fact their going to say take it off aren't they

Utley: No Crossbow notes would be converted to equity when someone else comes in.

Si? Of course, and that's gone. And those issues are gone.

Wheeler: Well, Yeah, so that it was the ...it was intelligent way to do it...and I'm not...

Buchsbaum: Crossbow would probably manage the million dollars anyway

Wheeler: By the way, if we did do a deal by which we tried to collateralize it even further, then we'd have to have some sort of provisions as well to get rid of your collateral.

Simon: Yes, of course. As soon as it converts to equity, it's gone.

Wheeler: But I mean, what if you didn't convert yours to equity[]?

Simon: Then you'd have to lose it anyway.

Wheeler: But at a point.

Utley: It just becomes a normal stockholder...

Simon: Right.

Wheeler: It would have to drop away or something. For instance, it would drop away when theirs drops away.

Utley: The stockholders, in the event of a default, the stockholders, the distribution that takes place, includes all the stockholders according to the rank of the preference. So the preferred get first cut, and the common stockholders get the second cut, whatever is left for

distribution. But of that amount[] unless there's nothing to distribute.

Simon: Not if one of the preferred stockholders has a collateralized position and the others don't. If one of these preferred stockholders...

Utley: There's no stockholders that have a collateralized position.

Simon: That's true.

Buchsbaum: You're talking about the small amount of money, that have any value, it should be reasonable value, and those would be taken out anyway.

Simon: Except that we seem to feel that we have an obligation to those, to protect the other stockholders who...had all good...I think its prudent anybody to ask permission

Buchsbaum: A good way to do it is the way he said to do it, and that's to [?].

Utley: Will you look it up and see what it's going to take to do it?

Wheeler: I'll coordinate that

Utley: I'm not clear. What are we trying to do? Are we trying to provide for collateral for new money coming in, or are we trying to...? We're not trying to collateralize money which has already been...

Simon: I don't know. Can you handle the old money the same way? I don't think so.

Wheeler: We have to see. We might be able to consider it for the full amount in the view of the fact that if you had enough substantial new consideration, ...

Buchsbaum: The problem is that you may have to go back to Crossbow to do that, and you may be better off just to do it on subsequent money.

Simon: Well, but to ask Don Kane to put up \$10,000 when he's got \$160,000 in the...\$135,000 in the company, and then he only gets 10%...\$10,000 worth of consideration...I'd like to protect his whole \$165,000, which is what he has.

Buchsbaum: The answer is you go back and ...

Utley: I don't think you can do that because that's equity. It's in common stock.

Bernstein: It's not equity. It's a loan.

Bernstein: Don had the stock prior to his putting up the money. These are loans. There's \$400,000 that's on the books. Then there's another \$100,000 besides what he put in originally. Sal has a loan on the books of \$25,000. Your guy should have had a loan on the books for \$250,000.

Utley: No, that's equity. Okay.

Simon: At any rate, <tape cuts out[tape does not cut out on my tape]>...While I got Chris here I'm going to take advantage of his being here.

Simon: One of the issues we tried to do when we raised the last \$80,000 that came from Eliot's two friends Anderson and Mitch Welsch. []

Bernstein: Ken Anderson.

Simon: It was my knowledge, according to Jerry, that those monies were to go to Eliot, and then Eliot was theoretically to loan the money to the company so that Eliot would have a loan on the books and he would have sold his stock because Eliot has some personal needs that he needs to accomplish as soon as we get funded or we get some money in here. I'm under the understanding again. It could be way off.

Bernstein: How do we work that out, Brian? The 10? A loan?

Utley: Yeah, that's better because otherwise you will get taxed.

Bernstein: Will they loan me \$10,000 to pay the taxes?

Simon: Who loaned you?

Bernstein: The company just today?

Utley: So I took that as a loan?

Utley: Yes.

Bernstein: The money went to the company, which spent the money already—the stock money—from Ken and Mitch.

Simon: You haven't sold any of your stock?

Bernstein: No.

Simon: You just made an officer's loan.

Wheeler: Right.

Simon: Is that how you handle it?

Simon: You loan the loan back by some method at some point.

Bernstein: Right. Correct.

Buchsbaum: That's the way to do that?

Utley: Well, there's no tax impact...

Simon: but he would have had a [] gain.

Bernstein: Right. And there were other things at the time...right, things. At the time, the company needed the money and I didn't...not that I didn't

Simon: Sure, I just wanted to make sure that it was done. I didn't even know ...???that bank account

Bernstein: Not that I didn't.

Simon: Let's finish up.

Utley: Eliot, let me summarize. I want to make sure we have an agreement of this meeting. Let me interject two final two points that we kind of skimmed over. One is you said that we want to go ahead and change the claims to go all the way back on this US, but we have sort of got covered on the one we're filing? The one we're filing is a PCT. It won't pop to the US for 18 or 30 months. Or we could file another PCT and a US, then the claims would hit the US. In other words what I'm saying is it would matter if we do the claims here. We could either fix up the claims here or file a PCT and a parallel US if you want US patent protection sooner. The PCT will split out to US, but not until later. You can file a US anytime...

Simon: Let me ask you. You're not a lawyer, what do you recommend?

Boehm: Well, it's more money up front.

Simon: How much money? A great sum of money?

Boehm: No, it's another grand to file.

Simon: For what we've spent already, let's do it.

Bernstein: And that protects us better?

Boehm: Quicker. You'll get a quicker US patent. It'll get you in line quicker.

Utley: The other point that you're making because in this week's filing we are going to claim all the way back...

Boehm: We're going to claim all the way back but this is what is supported

Utley: Right. So if we claim all the way back to March of last year, do we need to touch the filing that's already in motion?

Boehm: The one that's out there?

Utley: Yes the PCT. Do we need to touch that?

Boehm: No, no. There's a PCT and a US.

Utley: Right.

Boehm: The PCT, we will get a search back. In fact, we should get it in a month or so, and then you'll decide what you want to do with that, what foreign country and possibly the US, but he files the same thing basically in the US, and now it's in line in the US.

Utley: Right, right. But what I'm saying is if the new filing that we make this week creates priority all the way back and embraces all of the teachings of the prior...

Boehm: Zoom and pan stuff.

Utley: Zoom and pan stuff, filings, do we need to go and modify and update and amend those earlier filings?

Boehm: Those other two.

Buchsbaum: That's a good question would there be new recommendation?

Boehm: It depends on two things. One is how quickly do you want to get the US for the new filing? This is a PCT that we're preparing right now. If we file the US right away with it, then it makes less difference.

Bernstein: Less?

Boehm: Less difference because he's in line sooner. That's all. It just depends on how soon you want to get your patent.

Bernstein: Well, we want to go for the sooner.

Utley: The sooner the better.

Boehm: The sooner the better then let me play with this

Bernstein: Right.

Boehm: Plus you're gonna get an office action back from the patent office on him...

Bernstein: On that.

Boehm: For free. There's nothing involved.

Bernstein: Right, but it doesn't claim anything.

Boehm: I don't know yet. It claims...he'll get this blasted. It will will be rejected.

Bernstein: Yeah.

Boehm: It will be rejected. The question is do we want to fix this, or where are we with the other things? So there's no decisions to be made now on this, it's just that do you want to file a US and a PCT?

Utley: The answers yes

Boehm Yes

Bernstein: And we do want to fix the original work?

Boehm: We can decide that later.

Bernstein: Well, why would we leave it unfixed?

Boehm: Because you can't get two patents on the same thing. So if we fix this, you're not going to get it over here.

Bernstein: But then we lose the date.

Buchsbaum: No we don't.

Simon: That's what he's saying.

Buchsbaum: You really don't lose the date.

Wheeler: So were not going to...???

Utley: Because he's claiming all the way back.

Boehm: We may not. It depends on...

Bernstein: May and less, these are words that scare me.

Boehm: You don't like that, do you?

Bernstein: No, I do not.

Boehm: But I don't think this is the right time to make that decision now.

Utley: What is the right time?

Boehm: When we get some office action back on this patent. And when we hear from the patent office, we'll sit down say do we want to fix this, or do we want to fix this, or have we uncovered some killer Prior Art that blows this whole thing out of the water? You don't want to spend money right now if you can avoid it.

Wheeler: We've never done a search, have we?

Boehm: We did a search...I've done a search on...<Everyone talking at once.> on a dozen patents that really weren't on point. We didn't find any close Prior Art; and all I can tell these...

Wheeler: This was on imaging and video?

Boehm: Yeah.

Wheeler: That's incredible.

Buchsbaum: Yeah, it was huge.

Bernstein: If it is found impossible to do these things, why would people be doing them?

Boehm: I want to make...the tape recorders off, right? <Recorder turned off>

Buchsbaum: What does PCT mean?

Boehm: Patent Cooperation Treaty. It's a formal filing process for filing foreign patents.

Buchsbaum: Oh, that's the thing with the different countries?

Boehm: Yeah. So we file one application that splits out later to different countries.

Buchsbaum: Two years?

Boehm: Yes, but we'll get indicators before that. Our search comes in nine months, which is three months from now for the first one. But, Brian, they're searching this claim; this claim is crap. You're not going to get a good search on it.

Buchsbaum: So what? In six months or nine months, we'll start hearing from them?

Boehm: Yeah.

Bernstein: Well then we should do an alternate search on what you have.

Boehm: It's a judgment call. I mean, you asked me this question a while ago, and you said what would it take to get me comfortable because I'm kind of a pessimist and I'm an engineer, so I have that background where I look at it that it's half empty. It would take more searching, and it would take more searching inside the technical articles. And it would take quite a bit of work. I mean, I guess \$5,000, I don't know. It depends on what happens. Then, again, that will only raise you to a different level of comfort, that's all.

Bernstein: And then they'll say the same thing, and for another five grand, well get Rays to another indiscriminate level of comfort.

Boehm: Exactly. But we don't have to do that because we will be getting an article...

Bernstein: Right, from the searches.

Boehm: And from your investors because if I was working for them...

Buchsbaum: Let me put it another way. If you have somebody that will take this company and auction off the technology, okay? As it is existing...as it is unfolding, okay? And as the licenses come along. It's strategy. Some of these people bid on that. What are they really bidding on? It's potentials, right? Basically?

Boehm: Well, no, there's a present value of the technology. If you...

Buchsbaum: Well, not if you don't have patents issued on it.

Boehm: Well, sure there is. Sure there is. If he can get a royalty based on 2% of their products—or whatever it is—per minute, whether or not it is patented, absolutely.

Buchsbaum: My question is at what point does it become...is the efficacy there significantly enough from the standpoint of others now that would be doing their own review. You know, like, say a firm that would do the option. They'd have their patent lawyers take a look at what you're doing to see if they think it has a real good value. At what point does that come along? Is it six or nine months from now, basically? Is that when that probably would start to unfold as far as having a real relevant potential value? I've been trying to get a general..

Boehm: I understand your question. I guess I would answer...

Buchsbaum: General idea.

Boehm: If your licensees are spending a lot of money...

Buchsbaum: On your technology.

Boehm: On your technology, they're going to have their patent attorneys right now, today, go do a search, and they will have a good indication. They may come up with Prior Art that blows you out of the water. They may find nothing. They may not search it. They may say, we don't care about patents; it's the technology.

Buchsbaum: Reality, though, this is not the...more likely six to nine months as some licenses start to unfold here and as things start to come back, and that's when this thing will start to have some relevance more than it does right now? From the standpoint of the...

Boehm: That the patent will have relevance?

Buchsbaum: No, no. The technology has a value that can be created in the marketplace and turned to bidding.

Wheeler: Well, you can look at the technology as almost value added to the company. I mean, the company has worth because of the process and what we can provide and we can build it up. But it'll even astronomical more worth assuming that we have...that it's totally proprietary to ourselves. Now some companies have great technology that's proprietary to themselves, and it doesn't earn them money. For instance, Wang Laboratories went down the tubes. They had the best word processing, and they had the best of everything else. And, of course, a lot of their technology is licensed out there, as I understand it, to VisionAire and to...they did the true ones, and...

Buchsbaum: It's was also to get to the possible strategy for the company's investors, okay?

Utley: Right.

Buchsbaum: Or it may be at some point a window of huge value placed on this technology where you may take advantage of it.

Wheeler: Well, and to our investors, we have said, and we can continue to say, we are attempting to create a pool of intellectual property and protect it.

Buchsbaum: Okay.

Wheeler: But there can be no assurances that this will withstand the test of time.

Boehm: That is exactly it. And you never want even when it issues. You will get a good comfort level when you have a US patent issued in your hands.

Bernstein: Why?

Boehm: Because you've had an examination.

Buchsbaum: Because you've got some review.

Boehm: Because you have a presumption of validity.

Bernstein: That's why I'd like to get that first one corrected because that's the first one that's going to be examined.

Boehm: No, we've got one...oh, yeah, it is. It's the US.

Bernstein: And therefore I want that to be approved. The investors are going to say...

Buchsbaum: The first one that we're going to be issued will be issued in May.

Bernstein: And the investors are going to say what happened to patent one.

Boehm: 3/10 of 2000 was when it was filed. Typically a year...they'll get around to it within a year. Maybe it'll issue in. 18 months to two years

Buchsbaum: From right now or from then?

Boehm: From 3/10.

Bernstein: What is the process speed up? If you can show...

Boehm: If you can show somebody's infringing, you can have an expedited examination; but that doesn't always buy you much time, and you really have to get into the patent office the first time, and I'm not sure we can do that.

Wheeler: Wouldn't a good example of one way be that Apple had really great patents, and Microsoft was still able to come in and duplicate it, even though everyone knows they violated the hell out of the patent of Apple.

Boehm: Um, hum.

Wheeler: So I mean you could have a good patent and it could still go down the tubes. But another one I'm thinking of that did stand up was Polaroid had patents and Kodak tried to come in and do everything to distinguish, and wasn't able to and got clobbered, right? And there's probably a lot of every variation in between.

Boehm: Yeah. Wheeler: [Not in transcript this is strange here]

Wheeler: Are those the two extremes?

Boehm: Yeah,

Wheeler: those would be the two extremes.

Utley: Especially when it comes to method patents and software patents.

Wheeler: Yeah, what was the first thing that Brian

Boehm: ...and the more patents you have, the less chances. It's like putting out mine fields...less chances people to get around you. But if the original concept is broad enough and claimed right, Yeah, we can be okay.

Boehm: But what, the test - I guess what you're asking for is when we have that first claim promised, probably within two years of when you filed, which is March 10, 2000, I would probably say

Utley Doug come back, close it out again.
<Inaudible comment.>

Boehm: There were two points. One was the PCT and I got that in correct.

Buchsbaum: Right.

Boehm: The second point was everybody was saying you don't destroy documents. Lawyers do destroy documents; and in the patent realm, it is common practice to get rid of all of our attorney notes, but it depends on what the practice is in your law firm and your corporation. Most patent attorneys who use this practice that I've seen, it happens after it issues. You never do it before. I don't even like to do it then. I like to do it after all the...

Bernstein: I don't even understand why you're destroying it. If you've got nothing to hide and everything's on the up-and-up.

Boehm: But throw in the concept that I'm leaving the law firm. Let's say I'm leaving the law firm, my notes, who's going to follow up and destroy my notes to benefit you, because I do want them six months from now. Maybe that's what he's doing.

Wheeler: Yeah, he could have done it to protect you. He didn't want them around in the other office.

Bernstein: I don't know. I don't know. I don't even know if he knew he was leaving then.

Boehm: Now it's intentional!

Utley: But I want to comeback were going to file PCT and US on the new one. We're going to wait for the old one to get kicked back; and when it gets kicked back by the examiners, we'll then determine how we want to amend it. Is that what you said?

Boehm: No, I want to say something on that again. I think if you want a patent to pop quickly—if that's the goal, which sounds like it's a good goal—then, no, I think we should amend the claims with a preliminary amendment before the examination.

Utley: A preliminary amendment?

Boehm: A preliminary amendment.

Bernstein: Encompassing everything we can throw in there?

Boehm: Yeah, whatever support there is. But a preliminary amendment on whatever it is on the...

Bernstein: So we're going back to the original

Boehm: So I'll fix the 119 case yeah

Bernstein: March 3, 2000, to encompass what we've embraced.

Utley: When will you be in a position to recommend what that amendment will look like?

Bernstein: It should look a lot like the one we just did.

Boehm: Yeah, that's...

Bernstein: That's my guess.

Utley: When will you be in a position to...

Boehm: I'd have to...a few days...

Utley: About a week or so?

Boehm: Oh, Yeah, within a week, sure.

Bernstein: Okay. That's good.

<End of meeting.>



Lorraine Christine Hoffman, Esq.
Assistant Staff Counsel
The Florida Bar
File No. 2003-51, 109(15C)

**Exhibit F – Foley and Lardner, Christopher Wheeler and Iviewit
Representatives Taped Transcripts 8/2/00**

Transcription of Telephone Conference
Conducted August 2, 2000

Participants:

Eliot Participant, Jim Armstrong,
Brian Utley, Doug Boehm
Docket 57103-120

Note: *Square brackets [] are used to indicate inaudible or indecipherable text. Text found inside brackets indicates transcriptionist's best guess. Since speaker names are not specifically identified, transcriptionist has made an attempt to identify based upon comments made in conversation but cannot guarantee that each speaker has been accurately identified.*

Bernstein: Patent meeting.

Utley: ...all [it?] is is a set-top box doing that same function. It acts as a scan converter so that you can display on a raster display device as a pixel-based image.

Bernstein: Okay. I wanted to start out by just making that comment because I think as we go through this, we just need to be sensitive to how it's stated so that in certain areas we make sure that it's stated in the way that Brian just indicated.

Boehm: Let's talk about that a little bit more up front here. Brian, can you give me...when you say a display is displayed as a raster, not pixels, a TV display versus a monitor? Or both?

Utley: Both. They operate at different frequencies, they have different scanned characteristics; but basically, they are quite similar. In fact, the very early monitors were TV screens.

Boehm: The reason we focused on pixels is because we needed to draw a line in the sand where we said something went [eeky].

Utley: The technology is pixel based. There isn't any question about that.

Boehm: He's right. I mean, pixels, schmixels. Is there any other way to draw that line in the sand and just use pixels as one embodiment; and is there a way to define the way you would pre-pack an image when it's going to be displayed on a display in terms of raster? Or anything else that you can think of. What we're doing is pre-packing sufficient information so that no two picture elements, whatever the heck they are, are displaying the same piece of information. Right?

Utley: Right. Of course, the trap is as soon as you get into the digital world, you are basically in a bit image format unless you use a more complex method which basically is you describe...

Boehm: Which is vector based, you mean?

Utley: Which is vector based where you describe line segments as vectors, but that's very, very, very much more complex and it does not lend itself at all to this kind of imagery that we're dealing with here. It just doesn't work.

Boehm: And it wouldn't pixelate, obviously, when you magnify it.

Utley: We'd have other problems.

Boehm: But you'd have other problems, right. But we're not worried about covering vector-based systems in this invention right now.

Bernstein: But should we limit ourselves...but we don't limit ourselves, either, do we?

Boehm: I'm thinking that a court could hold that you are, yeah, because we're talking pixels all over the place. We've defined some of the claims in terms of how to draw that line in the sand in terms of number of pixels versus what's displayed versus what's pre-packed in; and maybe the whole string of claims wouldn't make sense unless you

were talking in terms of pixels or picture elements. Maybe we don't have the word "pixel" in every claim, but my point is that...

Armstrong: Is there any way to do it vector based?

Boehm: Yeah, there are generic ways...we'll, I'm not sure you want to do it vector based because now we can't draw the line in the sand.

Bernstein: Okay. I was thinking a separate filing if there was a way.

Boehm: Yeah, but I'm thinking of...you brought up a good point. We're thinking pixels or a digitized image. Technically, a photograph is grains.

Utley: Right.

Boehm: Is there a grain-based quality factor that we can tap onto?

Utley: No, not really. I think the closest...the part of that that [varies] is when you do the enlargement of the source photo image.

Boehm: Maybe we should talk data elements. Is there a...

Bernstein: That's the word I liked versus this...value data, additional data.

Boehm: But this is not...in the product, there is a big difference.

Utley: But because there's a big [batch] of formulas, you can't...<unclear; everyone talking at once.>

Bernstein: I understand that, I understand that.

Armstrong: But we could use data elements with pixels being an exemplary method for using data elements...here's one example of a data element, it's a pixel.

Boehm: The problem with that, though, is somebody could find a piece of Prior Art that uses the data for vector based.

Bernstein: Oh, [for no more beat] on vector base?

Boehm: No, if it's Prior Art...if it's done ten years ago...vector based...and you're saying in your spec that your claim language data elements cover is broad enough to cover pixel, vector based, and everything. Your claim now reads on the Prior Art, and your patent would be invalid. It could be interpreted that way.

Bernstein: Brian, were we ever able to do it vector based?

Utley: Well, there are certain things which you can do vector based.

Bernstein: That you can't do pixel based?

Utley: That you can do pixel based as well as vector based.

Bernstein: So we've got to be careful that they can't cross that same line.

Utley: Certain kind of graphics are done in vector based. For instance, AUTOCAD works on a vector-based system. CAD programs are typically vector based.

Boehm: Does the concept of your invention, of pre-packing the number of picture elements so you can zoom it and pan it, does that have anything to do with vector-based systems?

Armstrong: No.

Utley: I think, Doug, it really doesn't. Vector-based systems don't play here, and I don't think the data elements buy you a thing.

Boehm: I think it could buy you trouble.

Bernstein: Okay.

Boehm: A good point in trying to broaden it, and we'll keep that in mind...

Bernstein: My question is, so does this cover if you could do it on a TV for a set-top box?

Boehm: I thought it did until...

Bernstein: That's what I was after. I didn't know if a pixel was involved in a TV.

Utley: Not in a direct sense.

Bernstein: In the display sense, though?

Utley: No.

Bernstein: Because we make a distinction between...

Armstrong: <Inaudible comment.>

Utley: But I told you that. But you do...everything is carried up to a scale convertor which is simply a translation medium to translate from pixels into a raster.

Bernstein: Gotcha. Okay.

Utley: So you can display all of that on a laptop, and then it's direct mapping, pixel to pixel.

Bernstein: Or you can convert it to whatever you want.

Utley: Right. That's right. You can convert it to a NTSC or [Europal] or CKM or...

Bernstein: Or any display.

Armstrong: What about a game? I think if we look through this, we've set up our cover of game. You said that it need's to be...

Utley: Any kind of display device...

Armstrong: In it's invention, it's a calculation based on pixels, and we just need to be careful that the way this is worded doesn't preclude us from displaying it on a non-pixel-based system.

Bernstein: And that's what he just said. He said that...

Armstrong: He said we're converting the wordage here because we ran into it a number of times. As we all look at it together, let's just be cognizant of that.

Boehm: Absolutely. When we go through, we'll all keep an eye out for it. But when you say a non-pixel-based system is a raster system, I really don't agree with that. A raster is derived from the picture elements, right?

Bernstein: From the pixels. That's what Brian just said.

Boehm: Yeah.

Bernstein: So we can convert the pixels to any display medium we want.

Boehm: Yeah, but even if you look at the...when we get to some of the claims, when you look at the resolution of the monitors, they talk about pixels.

Bernstein: Well, that's what I'm concerned about a little bit.

Utley: Because what they're referencing when they talk about pixels on the monitor, they're really referencing the scan buffer that scans it out to the monitor, and it's not a representation inherently within the monitor itself.

Boehm: Oh, okay.

Utley: The monitor has no pixels. But the monitor has a [shatter vast] which, depending on the monitor technology, whether it's a Sony or a non-Sony—a Sony has an aperture grill—but they have a three-color dot matrix which has no direct connection with a bitmap.

Boehm: Oh, really? No association to the pixel elements coming in?

Utley: No, none whatsoever. A standard TV tube...a 17" TV tube has a dot-spacing at a [4.?] [4.?] inches, and a good display tube has got a lot of the diodes at .26, .27, .28 at the higher resolution, but it's where it's visually higher resolution, not necessarily what your scan buffer has.

Boehm: You don't turn the screen...the gun on and off for each pixel.

Utley: Right. It's a continuous beam scan, and you're modulating the beam.

Boehm: So I think the best we can do is keep that in mind when we talk about the language to converting this over to television [].

Utley: Yeah, on this page I did have an additional comment. On line 18 and 19, where it talks about ideal age quality requiring a minimum bandwidth for transmission. All I was saying here is instead of a limited bandwidth, it works regardless of the bandwidth, but it has less demand on bandwidth.

Boehm: Okay.

Bernstein: Let me ask you this. Let's say [] thought of the equation and just say you play our image off your hard drive. It's still cool, so it has all the features we're patenting. Why do I even care about a limited bandwidth? Why do I care that that statement be there at all?

Boehm: Do you have any knowledge...I mean, ...

Bernstein: No, I have no knowledge that in Prior Art you can pull off your hard drive any differently. People did not say to me, "oh, what you did is cool because you can play it over a network." They said, "it's cool, so I'm gonna play it off my hard drive." And by the way, in the end, the file

is on your hard drive. Even if you had a 2400-baud modem, the only difference is you have to wait 11 minutes to get the cool image. The coolness did not decrease by the time it took to download the image.

Boehm: Okay, again, we'll keep that in mind. I believe it's covered when we claim the digital image file because I don't think the digital image file claims pertain to a network. Let me...

Bernstein: None of it should pertain to a network really. It's an added benefit that we're able to transmit these rich pictures over a limited bandwidth network, but it is nothing even close to dependent or part of the coolness of the invention.

Boehm: Can I take a counter-position, sir?

Bernstein: Sure.

Boehm: The reason that you'd want...first of all, you have to describe the best mode of your invention. There's no question we have to leave network in there.

Bernstein: That's fine. Okay.

Boehm: And the more stuff you leave in there, the better it is for us.

Bernstein: As long as we're not limited to it.

Boehm: The claims are what defines what's limited, but again, if we are so broad brush in...the claims are interpreted in the language in this...

Bernstein: Well, don't be broad here. If you want to be broad, it can be your hard drive or it could be over a network, it doesn't matter.

Boehm: Right. The problem would be if the digital file that we're claiming in some claim #29 or whatever, if the wording of that claim says "uploading"...no, it says "transferring data," and that would mean over an Internet, and in the

spec we come back and say that means over the Internet or...

Bernstein: ..or your hard drive, yes, I agree. That's why I put in some places upload, download. I don't care what you call it, don't limit as to download what I see in some places.

Boehm: Okay, that patent issue is three years down the road you sue your closest competitor. They had a guy that just came out of the print industry, and they have been downloading images in print off of hard drives for photo-processing applications for the past twenty years. He comes out with one article. Your claim directly reads on it because it's off the hard drive now because you have interpreted that claim to mean off a network. Your claim is dead.

Bernstein: No, but that's not...

Boehm: Then you run to claim two, which is dependent on one, which is going to say, by the way, it's over a network.

Bernstein: But it doesn't have to be.

Boehm: Claim two will have to say that, yeah, because otherwise your patent will fall, Eliot.

Bernstein: Why?

Boehm: What?

Bernstein: What my question is...

Boehm: Why will it fall?

Bernstein: Let's stick to the invention.

Utley: What he's saying is...let me see if I can...claim one is as broad as possible. Now, if something happens to [] on claim one in the Prior Art, you bypass that by going to claim two, which leads on claim one, which further defines claim one, which

takes you out of the concept situation and into cleaner.

Boehm: Right. You've narrowed the scope of your part of this technology world—the part that's protected—but you want to make sure that part is over what your business is.

Bernstein: Well, my business is...you see, my business doesn't need to involve a network. I could send somebody a CD of their hotel properties, like Hyatt, and say, "Here, you still have all the cool effects of my digital imaging products..."

Utley: But claim one doesn't say anything about networks.

Bernstein: Okay. That's all I'm saying, Brian. As long as you're not limiting me to a network.

Utley: Claim one doesn't. We used that deliberately.

Bernstein: Okay.

Boehm: I'm going to talk about that again when we get to claim one.

Boehm: Let's talk about that when we get there, but again, my point is is you've got to be careful about what you say in the spec because the way claims are interpreted is by referring to the spec. When you say "providing a digital image file," that doesn't mean much in the claim. The guy's going to go read the spec, see how you did it, look at your figures, and that's how this language is going to be interpreted. There's no broad brush back there. And you say, "oh, well it means everything," now claim one means everything, it reads on all the old prior art.

Bernstein: But it does, Doug, mean the hard drive, the CD...

Armstrong: Let me say something else. Let me suggest that what we're really saying, whether it's over a network or off the hard drive, is that the unique nature of our process results in high-quality

images at low-file size, and so whether that low-file size...

Utley: <Inaudible comment.>

Boehm: Well, it's not file size.

Armstrong: Right. It could be huge files.

Bernstein: It could be huge files...

Armstrong: Hold on. Isn't it true that it is a low-file size given the amount of information that you're able to draw from it?

Bernstein: No, it's the large-file size. It's the opposite. You gave them more data. The file size is not relevant, nor is the bandwidth. That is a must-understand. This idea is cool whether it's played off your hard drive, played off the CD, played off the tape back-up, whatever you want to call it, over a network...whether you Fed-ex, this, Doug, because the [single] fact is whether you send it over the Internet, and that effect is the same as if it is a 2400-baud modem receiving it or a super-high-speed, as if the only difference between Fed-ex and the Pony Express is three days' wait, but you still are going to have this same package.

Utley: Right. But what you want to do in your claim is make sure that you're not...

Bernstein: Limited.

Utley: No, make sure that you haven't stated your claim so broadly that what is over here excludes your ability to claim over here. So you parse the claims, one very broadly, and then you keep narrowing it down so that if something happened over here, you've got...the network delivers it to you.

Bernstein: Okay. And if you're saying that limited bandwidth isn't in claim one, then we don't care.

Utley: Right.

Bernstein: But I just wonder why it needs to be here other than to describe what we did. You don't, by the way, need a network to describe what we did.

Utley: So we can strike network. We don't have to.

Boehm: Well, we're not striking it. We can take it from the claims when we get there, but I've got to leave it in as your preferred embodiment. That's important.

Utley: Right. We're on page one.

Bernstein: Why? Let me ask you why.

Boehm: Okay, there's something called the best mode...

Bernstein: Okay, let me explain that to you because I do understand that. The best mode of this invention stops as soon as you have the image, whether you ever sent it or not, or played it on your computer for that matter.

Boehm: Okay, Eliot, I don't think you would want to stick to that statement. You're saying right now that your invention is so bloody broad that if somebody had done this before on CDs but never done it on the Internet, and we can go sue them because they're now doing it on the Internet and your claim is there, and when you interpret your claim to read "on the Internet," and that's all you ever care about, but now we're going to get you up on the...

Bernstein: That's not all I ever care about.

Boehm: You care about stopping your competitors.

Bernstein: No, but I care about putting it on CDs and all those kind of things or using it for any other application. That's the key here, Doug...the file creation—the concept, the invention—stops before it ever hits the network.

Armstrong: What Eliot's really saying is that our invention does not include a delivery system.

Boehm: Right. So in one embodiment, it would. If you wanted to put a picture claim on your business, it's going to be one of our claims that includes a network, that includes pixels, that includes...I want a pixel claim...

Bernstein: That can include.

Boehm: Pardon?

Bernstein: That can include as one of the methods of delivery, but the delivery method could be a network, a hard drive, a CD-ROM, etc. As long as you cover all that, I'm fine.

Boehm: Okay, what I think we're arguing about is the mine field. You want a claim that's broad enough that if it gets blown away, okay it gets blown away; but I want a claim that's narrow enough that there's a less chance of it being blown away by Prior Art sneaking out of the woodwork because we're not experts in this field like Chris Taylor or something that could say, "Oh, you can't do that...here's a reference." That's why I'm a little...

Bernstein: Can't we say that that's an added benefit of what we've done? I mean, I don't want to be confined to a network, that's for certain.

Utley: You're not.

Attorney: Okay. In one claim, you're not; in another claim, I want you to be.

Bernstein: Okay, that's great. That's what I'm saying. AS long as you've got me covered on CDs or DVDs—somewhere in the future—that's fine.

Boehm: Okay.

Bernstein: Um, page 1.

Utley: In fact...I just want to cap this conversation. When you go through the methodology of the

creation of the image and the display of the image and the formulas, there's nothing about a network.

Bernstein: Nothing.

Utley: Okay. So all of that gives you total freedom to claim wherever you want to place that...whatever environment you want to place that. I did have a thought, Doug, on the display and a way to kind of be a little bit more embracing.

Boehm: Than pixel based you mean?

Utley: Yeah, instead of saying display monitor, we just say display system, and display system can be defined as anything with a visual user interface, be it a TV or...

Boehm: That sounds...where is that?

Utley: Page 2, line 6, is the first one. It says "display monitor." If we just say "display system" wherever we have "display monitor"...

Boehm: Okay, not everywhere. This is the background. We're not really talking about our invention yet. The first time we talk about display is describing figure 1, which is element 3, is the display, so that's where we'll stick in it's the display...just the word "display."

Utley: Okay.

Bernstein: Yeah, system. Right.

Boehm: So, let's hold that in abeyance.

Bernstein: I had a comment on line 15: "Improved resolution for zooming and/or panning within a single image."

Boehm: This is the field of the invention. That's fine if you want to say that. All this paragraph does is points the examiner in the right art for the search.

Bernstein: Okay, and I would just clarify, too, on that, it's a single image, not a bunch image—the zooming and everything. This is one file that has all these attributes.

Boehm: Right. So it's "and..."

Bernstein: It can be additional files added into it, but those files retain the single image.

Utley: As long as it's understood that a single image embraces fixed images.

Boehm: How about a single window?

Bernstein: How about a single file?

Armstrong: That's probably good.

Bernstein: That's the right terminology.

Armstrong: Line 22 seems to me to be an incomplete sentence.

Utley: It is.

Armstrong: It should say, "It is known that one can view a digital image on a display."

Utley: That's what we talked about yesterday, Doug.

Boehm: Yeah.

Utley: And you had terminology for that.

Boehm: Yeah, let me find that. I know I do, but apparently it's not that handy where to go. Yeah, here. We're talking about in the Prior Art it is known.

Utley: Right.

Boehm: And that's the concept. I can fix that sentence by saying...

Bernstein: That "one can" instead of "two."

Boehm: <Speaking as he writes.> "It is known that one can view a digital image on the display screen..."

Bernstein: In other words, it is known in Prior Art or whatever.

Boehm: How about "It is previously known that...?"

Bernstein: Yeah.

Boehm: Okay. "It is known."

Armstrong: "It is known." Period. Previously or now. "It is known that one can view..."

Boehm: "...one can view a digital image..." and get rid of two..."and zoom and pan within that image." Right?

Utley: Uh, huh.

Boehm: Boy, at this rate this is going to be a long conversation.

Bernstein: Yeah, it is because we go now to the next page, too, thank God, and where it's circled pixels, let's just be clear.

Boehm: I'm sorry, I've got to back up. "The limited bandwidth network," how are we changing that?

Utley: We're going to remove that.

Boehm: We're going to get rid of what?

Bernstein: Well, you don't need it.

Armstrong: Delivered through its display system. "The viewer desires ideal image quality delivered to his display system."

Boehm: Okay.

Utley: And then you can go on. "In a network environment..."

Bernstein: This is even more...

Utlely: Right. And then you say, "In the network environment, it's important to transfer an [idea or image] in a reasonable amount of time."

Bernstein: There you go. That covers everything. Okay, so we go to pixels and pixelization terms, and my question is, and Brian will help me here, when you're looking at the screen and you zoom, are you seeing pixels?

Utlely: You are seeing pixels.

Bernstein: But the screen has no pixels.

Utlely: No, but pixels are mapped into a raster-based generation; but yes, there are pixels.

Bernstein: Okay.

Utlely: You see pixels.

Bernstein: Okay. You do?

Utlely: Yes. There's no pixels but yet you see them?

Utlely: It's not a pixel-based medium, but the raster presents pixels.

Bernstein: And it presents them distorted?

Utlely: It will present them distorted.

Bernstein: Once you magnify them?

Bernstein: Okay.

Utlely: It may take more than one raster to represent a pixel. In other words, a pixel is a composite. If it's a very large pixel, it'll take several raster scans to create a pixel.

Bernstein: But you will still see...

Utley: To see a pixel.

Bernstein: And then when you blow it up, you'll still see a distorted...

Utley: Right.

Bernstein: Okay.

Armstrong: This is the first opportunity where if we wanted to, we could say, in line 3, "...in which the pixels (data elements) comprising the image"...

Bernstein: We can't.

Utley: We don't want data elements, we don't want data elements.

Bernstein: Because do you see what's happening? You still are drawing off a pixel base.

Boehm: Pixel, and then this is goofy because in the next paragraph, we define what a pixel is. We're defining pixelation first, and then next we're defining pixel. Why don't we not define pixel up above...oh, yeah, I have to. "In which the pixels, i.e. picture elements..." How's that?

Bernstein: Yeah.

Boehm: In other words, everybody knows what a pixel is, but we're just throwing it...

Utley: It's a picture element.

Bernstein: Okay, that's fine.

Boehm: "Pixels, i.e., picture elements."

Bernstein: Right. That might even cover us in other space that we don't even know yet. Okay. Go to page 3...

Utley: On line 6, this is an opportunity to introduce the notion of a display system instead of a display monitor.

Boehm: It is...

Utley: Is that a problem to you?

Boehm: It depends on where we have to go with it, Brian. Where do you see us going? Do we need the differences defined later?

Bernstein: You should be very accurate there, Doug, because when this was invented, I ran my computer class through my TV at times. So it was through both displays. Remember, Brian? I brought you over. So I've always been running through a scan converter, my TV.

Boehm: So where do you want to go with this, Brian?

Utley: I just want to say "display system," and the reason I say that is because if you say display system, you integrate into the description the scan converter. If you say "display monitor" itself, a display monitor does not contain the scan converter. That's generally housed outside in a set-top box or in the computer hardware itself.

Boehm: Okay, I agree with you that you want to make that distinction; but do we want to make that distinction? We're still in the [background]. We're describing somebody else's, not ours yet.

Utley: Yeah, you tell us where you think the best place is to put it, Doug.

Boehm: Well, I definitely want to put it when we first represent what display 30 is.

Utley: Okay.

Boehm: What I don't know if...

Bernstein: Okay. By the way, here it's true, too, [what he says]. Brian's saying...

Boehm: It really is.

Bernstein: Yeah. In Prior Art, if you play that on your TV, it's still pixelated. It didn't matter if it's a monitor or TV. So Prior Art, no matter how you played it, did that, and that's good to say.

Boehm: In the background here, it's not important. What we do in the background is try and set up that the strawman of the Prior Art had these problems, and then you knock them down with your invention. So whether you set him up with the display or display system and you knock him down, he'll fall just as hard. I don't think that's going to make a big.

Utley: That's not a big deal here.

Bernstein: But it has to come somewhere in here.

Boehm: What if we're making some stupid statement here. Let me read those paragraphs to you real slow here, and then let's make a call on it because; or if this is a good opportunity where we have to figure out the difference between a raster and pixel-based system or scanning lines or anything, if we have to make that...if we have to educate the people in order to interpret the claims later, then now is as good a time to educate them as far as what's the background. I don't think we need to do that.

Armstrong: I personally feel that if we're going to be later using display system to define more broadly how we display things, we might as well refer to Prior Art in the same way since it does include it.

Bernstein: It doesn't hurt. It can't hurt because all it's saying is that Prior Art, no matter what system you played on. Here what you're saying is Prior Art, when you play it on a monitor.

Boehm: I guess just from experience, there's really no right or wrong answer on this, guys; but just from experience, I would tend to disagree with you. Whenever I define a term that I care about,

I always define it in the spec, especially if it's not a normal, common, everyday-type term that you want to talk about in the background because when you're saying that it's the same in the Prior Art as it is in your invention, you say that today and you may want to argue that today, but maybe you want to change your mind tomorrow; and when the litigators litigate this, they're going to wish like hell you never said that it was the same in the Prior Art.

Bernstein:

Okay.

Boehm:

You can point to your spec and say, "voila!"...

Bernstein:

And say we were working on our TV...

Boehm:

...our display system, and it's defined as such.

Bernstein:

That's fair.

Boehm:

And you can't go back to the Prior Art to define it.

Bernstein:

Okay.

Boehm:

So there's legal ways of doing it.

Bernstein:

Okay, so let's see where we insert that correctly.

Boehm:

Yeah, I think it'll be later when we're talking about element 30 when he defines the blocks of the system. Let's see...

Utlely:

On line 14, where you say "represented as a triple..."

Boehm:

Yeah?

Utlely:

I think the correct word is "triplet."

Boehm:

Okay, Steve pulled this from something on the Internet, so if you say "triplet," that is right, yeah. Triplet. Good catch. It took five of us to catch that! <Reading out loud to himself...> Here's the bandwidth.

Bernstein: Yeah, "...thereby speeding the transmission." Now that is true, but it's not necessary.

Boehm: "...decrease the file size..." No, he's got it right here, right?

Bernstein: Well, "...this results in a small source image file size," period.

Boehm: No. The whole sentence says "plus the teaching in the art..."

Bernstein: Okay, okay, yeah. That's right.

Boehm: No background. We're still setting up the strawman to knock him down.

Bernstein: Gotcha, but we don't need a network or Internet.

Utley: We're not talking about us—we're talking about the other guys.

Boehm: Yeah, Prior Art, and they were compressing the hell out of it and moving information because they knew they had to go through this...

Bernstein: No, but let me ask you this. Let's say you just set it up on your computer—you never put it on a network, I'll just give you the same argument—you wanted to display your family photos on your own display system. You built a frame, you put a picture, matched the size to the frame; and voila! It's on your system, you can't do anything with it. You can't zoom. You haven't communicated it over a network; you haven't sent it to anybody...but you still can't zoom on it.

Boehm: But you still can zoom and pan, you mean?

Bernstein: You still can't.

Boehm: Oh, you still cannot?

Bernstein: No, because you built the frame wrong.

Boehm: Oh! Okay, okay.

Bernstein: So I mean you built the image to target wrong.

Boehm: Oh, I see what you're saying.

Bernstein: Yeah. So it didn't matter if you transmitted over any network.

Boehm: Now this will get really hairy...how did you build it wrong?

Bernstein: Well, because you only gave the frame the appropriate size as was necessary to fill the frame.

Utley: You designed the frame to the edge.

Boehm: Yeah, so it doesn't magnify at all?

Utley: Right.

Bernstein: Right, whether you had a network involved or not.

Boehm: Okay, and if it's a little bit bigger than the frame, you can still pan but not magnify—but not zoom.

Bernstein: Right, but the teaching in the Prior Art would be to match the frame to the image.

Boehm: Okay.

Bernstein: That's how the world's been working for a long time.

Boehm: I totally agree. Maybe we should throw that...does that say that here?

Bernstein: Well, I guess there are a lot of places where we're going to add it.

Boehm: Well, that's a great line what you just said..."match the frame to the image."

Bernstein: You see, that's going to become critical when you say that "two times magnification at least" because the truth is nobody built a picture saying, "I'm going to give it a little more edge so I get a little more zoom." That's the difference. You built the picture...you had a frame size...you popped in their image to be that frame size...you created the image for that size. You didn't say, "I'm going to give them an extra pixel so they can zoom a little," or an extra pixel or two, or two times. So one drop, one pixel more than is required, is the new out.

Utlely: Well, the only thing we have to be careful about is that there are applications that allow you to create an image which is larger than your viewing window and operate on an image which is larger than your viewing window. What's different is that that image, when you see it in the viewing window, what you're looking at is the image as it is intended, you're not looking at a compressed form of the image--by compressed, I mean a scanned form of the image--so that...

Boehm: Or it sits in the frame.

Utlely: Right. So it's not sized to the window, it's sized to the system frame, whatever the application is, but it doesn't allow you to zoom into the image which will all you to avoid pixelation.

Boehm: Right, and I [] when we had Chris Taylor say he had done years ago on his website...you can look at his website, by the way--msoe.edu--and Dr. Chris Taylor has his own link to his own personal web page, and he...

Bernstein: Where is it?

Armstrong: msoe.edu.

Boehm: msoe.edu, and Dr. Chris Taylor is his name, and it'll have a subdirectory for him. Then on his subdirectory, it'll say, "Go see images from my own website," and then he has his own personal

thing; and in that, he has pictures of stuff. And he says those pictures, which were done way before you guys—when he first got here to Milwaukee, I guess is what he said—but he said that there are more pixels there than are needed, and that's just the way it just happened to come out. There was no intent to do it one way or the other way—he didn't intentionally match the frame size to the image—that's what happened when he did it. But he's not providing scanning and zooming, and...

Bernstein: Well, that's the difference.

Boehm: And, but he is not providing more than two times the pixels.

Bernstein: Well, that doesn't matter [] because really we're just saying that our art is based on the fact that we're providing extra data that allows, whether it's one pixel or not. One pixel might give you a zoom factor of .00004...

Boehm: I see what you're saying...

Bernstein: So why should be ever limit...the object of the invention is to create zoom by giving more data.

Boehm: Right. Can you zoom, Brian, without going twice the number of pixels?

Utley: Sure. Well, you can zoom to...what you're saying is you have a target image which is 2x the window, or 2x the viewing image, and, yes, it can be anything over and above the size of the viewing image. It's just a practical question of does it have any value...

Boehm: Right.

Utley: ...when they have such a limited...

Boehm: Magnification factor.

Bernstein: But we don't know into the future if it will. Somebody could get around us by getting it

somehow under a 2, or, as a matter of fact, what if you only need 1.5? Why should we limit ourselves because that's not what was created?

Boehm: Okay.

Bernstein: You know what I mean? We didn't pencil it out and say two times is what we need to do this.

Boehm: That's a good...we got that...Steve and I must have come up with that two times.

Bernstein: We all came up with it just because the first button on your magnifying glass is two times.

Boehm: Okay.

Bernstein: And we were thinking...here was our thinking...that you were able to click that button on a regular image, and you were still okay—a little fuzzy—but you hadn't blown apart. So we were thinking anything beyond that. But actually as I re-thought that, I said that's not the issue here. If you're designing screen size to match frame size, it doesn't matter if you give it one drop more. That adds to the zoom capability by some factor...that extra data. But one and half times. What if you only wanted...what if your client says "I've got a picture of my wife, and she's ugly, so I only want a one and a half times magnification on her face."

Utlely: Okay, we all agree.

Armstrong: Anything more than one times is the definition.

Boehm: And I think he's got it in claim 1. He scratched out "at least twice" and put in "is greater than."

Bernstein: Right.

Utlely: So the right way to say that is that the target image is larger than the viewing image, and you've said it.

Boehm: But just claiming that concept.

Bernstein: Right.

Boehm: No...and providing zooming capability?

Bernstein: Absolutely.

Boehm: Right.

Utley: Which is the way you have it worded in claim 1.

Bernstein: I don't care if you built the picture and your frame size was "x", but that wouldn't achieve anything that we thought was cool. That would just mean you have an oversize picture in a frame and you could move around by grabbing the picture. By the way, that brings me to what made us start thinking about this was your Adobe example. You are grabbing a larger image, but you're moving it around kind of clumsily and it's not achieving what we achieve. Do you follow? Because you're just grabbing and kind of moving. As a matter of fact, there's a technology that's out...

Boehm: Yeah, but you can zoom, zoom, zoom in there.

Bernstein: Yes, straight in, and then you've got to grab it.

Boehm: Yes.

Bernstein: And move the larger image from that portion around. There's a technology called [Zif X] out today that allows for something similar to that, but yet it's very annoying that once you're in, you're in and have to grab and move around. It's a much different effect and feel than what you get when you look at our images and grab and move around. You know what I mean? In our image, the whole thing is there pretty much.

Armstrong: And this is a distinction that we begin to make on page three where the ability...our art allows you to, on a single image, once that image is received by the system or displayed on the

display system, it is complete. You're able to zoom in and pan around on it, and there isn't a requirement for the system to re-draw the image or any section of the image.

Utlely: No, no, no, you can't say that.

Armstrong: Why? Let me first say what I'm saying, then we'll take out the parts that are wrong. Then the difference between some of our competitors is that they require if you are to zoom into an image and look at that zoomed portion of the picture and then pan at that zoom level to another section of that image, that image needs to re-draw the new information in order for you to see it.

Utlely: And that's the trap because. In fact, the display system only buffers what is on the screen; and when you pan, you refresh the display buffer.

Armstrong: Even in ours?

Utlely: Yes. You have no control over that.

Armstrong: But you have to because that's how you get a new image.

Utlely: That's just the way the system works.

Armstrong: Right, right. You can't really do without what you're seeing on the screen. You've got to redraw.

Armstrong: Well, maybe this is the distinction for..

Boehm: But you're not grabbing a new file...you're not grabbing more files.

Armstrong: Right, and that's what I was about to say. The distinction perhaps is for the delivery over a network, and that when it is delivered over a network, they require the transmission of additional data, whereas our data has already been received in its totality.

Boehm: Well, that's the exact thing that the Yahoo! Map will do, right? You want to zoom into a map...

Armstrong: Precisely.

Boehm: ...it grabs a new image, and there is the network. But what Eliot was saying earlier was well why not make the network the link to your hard drive.

Bernstein: Right, it is.

Boehm: So then do you have to go get more information off the hard drive? That's the question.

Bernstein: Yeah.

Utley: No, be careful because in this day and age of virtual memory systems, there's a big grey area between the RAM and hard drive. The system may put part of that image on the hard drive.

Bernstein: It might put part in RAM; it might put half of it in the network.

Utley: That system can reside in several different places, and you don't know it. The system is managing the resources.

Boehm: I agree. So we have to figure out how to define in broader terms, just put it in memory or, I don't know, put it in sourced image storage. In other words, if a file comes over and gets lumped in Memory Means A, then it gets displayed to the display using however you want to do it, the question is, when you're zooming, do you have to go back to Memory Means A, whether that Memory Means A is across a network or on your hard drive or in a different PIM.

Bernstein: Or B, that's right. And that's a big difference, Brian.

Boehm: Because now you're getting real technical, and I don't know that you're not doing that.

Utlely: The problem is that as you try to increase the precision of what you're saying, you have to be very careful.

Bernstein: Well, then we've got to take back "...one drawback of this type of system is that each zoom or pan operation requires the downloading..."—downloading is definitely the wrong word—"...of additional data over the network..."

Armstrong: Line 8?
Bernstein: Yeah. That's all wrong.

Boehm: What page are we on?

Bernstein: We're on page 3, line 8: "One drawback of this type of system is that each zoom or pan operation requires the downloading of additional data over the network connection." Well, that's not exactly what we're...

Utlely: We're talking about the art...the state-of-the-art now. We're not talking about...

Bernstein: Or mapping the travel?

Utlely: We're not talking about our system.

Bernstein: Okay. Then that's fine.

Boehm: That's exactly what the advantage of this system is, isn't it?

Utlely: Yeah, exactly. It's not designed to work that way. It's designed to be an integral component of the displaying system.

Boehm: And also we're talking about the Yahoo! Map.

Bernstein: Once again, however, it's not limited...Let me ask you this question because I don't see networks at all, right? Let's just look at the Yahoo! Map program.

Armstrong: I've got it on CD ROM.

Bernstein: No, no, that's okay. I know what we're doing. When you move, whether you move on a network or off the network, it grabs that image, and it's different than what we look like. There's a definite difference of how those two things work. Do you follow me, Doug? So it doesn't matter whether it's on your hard drive drawing the data, over a network drawing the data, what matters is that you perceive a difference between the way that the Yahoo! Map goes and grabs another closer section of the map and you're stuck there. Now you can't move back without going backwards to that other image or to the left to that other image or to the right to that other image. All these things are broken down into "other image" basically.

Boehm: Right, you're getting another what you called the hotspot. These are all hotspots.

Bernstein: Right. Which is that technically a new file?

Boehm: That's a new file.

Bernstein: Then maybe that's our differentiation.

Utley: We have to be careful.

Bernstein: Well, we don't go from another file.

Utley: No, but they're going to go...

Bernstein: They may say that's all in one file. Right.

Utley: So that would be...

Boehm: I think that they are going for another file because whenever you click on another map...

Bernstein: So Brian's right. So what? Even if they were and there were 8 million files, we could combine it into one and call it one. But then if you just made what we do...

Utlely: Uou really have to be very careful because you don't know how they organized and structured that whole mapping system.

Bernstein: You know what you do, Doug? You describe the optic. You say this is what you see with their system, and this is what you see with ours.

Boehm: That's what we're trying to do here.

Bernstein: And let's not let that get too complicated. Let's what we're trying to get explained out over time.

Boehm: You can't.

Bernstein: If somebody wants....

Boehm: That's the key. That's what our frustration is as patent attorneys. We have to define your invention in the legal technical words. You can't wave your hands at it. If you do, you won't get a clean street of passage.

Bernstein: You can't say it looks prettier?

Boehm: It won't be upheld in court.

Bernstein: You can't say it looks prettier, huh?

Boehm: No, you can't. And that's what I'm saying. I agree with you...I'd love to say, "When it looks like idea technology..."

Bernstein: Well, explain to me what's happening in my brain, then, on an electrical signal impulse, because there's a definite perception definite between what I see, why I see it differently, and how it relates to what I do, which gives you a completely different spatial representation within an image because of the way that I'm manipulating data. See, I always looked at our technology—and maybe this stupidity might define something here—I always looked that when you take that big image of ours versus one technology where you could...let's say we both have big pictures, okay? Let's just say we both go with the big picture in a small viewing frame. One

says you can move the frame or the picture and get a new image of that image, or you can go deeper on it by drawing another whole separate image, okay? Mine, I always looked at it is that it puts the frame in the center; and as you hit zoom, you're sucking in data towards you that's coming from the outside peripheral, not in separate little chunks and new images, but as one image, and it's pulling it into like a vortex, so to speak, and giving you that new data to let you zoom or move. Follow me?

Armstrong: Let me ask a clarifying question of Brian. When we transmit a file to a user, he gets the entire file into a .TMP file?

Bernstein: No, it's just hard drive.

Armstrong: Right onto a hard drive. Now, as he manipulates the image on his screen...as I zoom to level one and then to level two or level three, or I pan within it, what sort of access to that file is made inside the computer, let's say?

Utley: It varies.

Armstrong: Okay, but there is regular access back and forth to data points within the file?

Utley: Yeah. Part of the picture may be residing on the file; part of it may be in active RAM.

Bernstein: Doug?

Boehm: Um, hum?

<Utley and Armstrong continue their conversation in the background as Bernstein continues with Boehm.>

Bernstein: Let me ask you to try and help me define something. Take a frame...take a small piece of paper and make a frame, okay? You ready? You got a square piece of paper?

Boehm: You want me to cut it? Yeah, I've got a sticky yellow pad here.

Bernstein: Perfect. Use that on top of your patent application and put it in the center. In my thinking where I don't understand that, when we do the Prior Art, when we take that frame and we want to see the upper-left corner—now remember, our piece of sticky is in the center—we now want to go to the upper-left corner, we've got to move the frame over the upper-left corner and now we're seeing that part of the paper.

Boehm: Which means you're moving the viewing window over a huge image.

Bernstein: Right. Or, you're moving the image to fit in the frame.

Boehm: Right.

Bernstein: Okay. Now with mine, put that viewing window in the center again; and let's say you want to zoom in or go to the...zoom in, what you're really doing is sucking in this data, aren't you? You'd be almost pulling through the paper through that frame. That's why you have that attached.

Boehm: No, what you're doing is you're scaling the...

Utley: You're scaling the total image.

Boehm: Yeah, the total image specifically or to fit a reduced frame.

Utley: But they're leaving the image as it is.

Bernstein: Ah, then there is a defining difference.

Utley: I know, that's why you call it zooming. That's why the invention is described the way it is. That's why when I do all the pictures and show all those relationships, that's why it's designed...it's laid out that way.

Boehm: Can we define our zooming in...

Utley: In fact, there's a scaling...

Boehm: ...as a scaling mechanism?

Utlely: ...viewing window.

Bernstein: That's the question...can you...

Boehm: Can we define our zooming as the scaling of the image to a different window, which is the normal way, I think, of zooming and scaling. I don't think of...

Utlely: The effect of zooming is to rescale the target image into the viewing window, or some portion of the target image. What you're doing when you zoom in, you're now scaling the complete target image to a portion of the target image, and then what you're able to do is take that scaled portion and move it around to the entire image, but it's at its given scale level. You don't have to re-compute the for every portion of the image.

Boehm: Right. I think we're fine with what we're doing. I just think we've got to...there's this topic 14, to be cognizant of as we go through this, to make sure that we distinguish our zooming from hotspot zooming by zooming by grabbing another file.

Bernstein: Right.

Boehm: Our zooming is scaling.

Bernstein: It's also by grabbing another file because it would be our view that that set of hotspots could be combined into a single file, and it definitely could be designed that way. I mean, I could write the file to be that.

Utlely: But it would be another file?

Bernstein: No. I could take all five hotspots and write them into one file.

Utlely: So the [] will be in one file?

Bernstein: Right. Exactly.

Bernstein: So you've got to be very careful here of what the difference is. It's such a minute, yet it's such a profound difference what we do...

Utley: But it is another image.

Bernstein: It is another...right. Not another file. That's the difference, right.

Boehm: It's another image?

Utley: Yes.

Bernstein: Of course. A hotspot would be second shot of that image at a closer scale...at a closer view...but it could be combined in one file in the end, even though it's two separate images. And the hotspot could drive right through it in that single file source.

Boehm: I'm thinking that if the mechanism for our zoom is to do the scaling kind of on the fly as you're walking around, we never go grab for another file...

Bernstein: Or we never...

Boehm: Hotspot or not—I don't know how many you put in there—you see, what I'm worried about is, guys, don't you have hotpotting on your website?

Utley: No, here's what...

Boehm: Yeah, we've had them.

Boehm: You've had them, right.

Bernstein: Yeah.

Boehm: And that concept of zooming is grabbing another image file.

Bernstein: Well, but it has the same attributes as our current file, so it's just grabbing another enhanced digital image.

Utley: It's grabbing another image, and you don't have to define it as a separate file. Just grabbing another image. Let me tell you what I think differentiates between one of these systems and what we have. We have, if you think of the target image as the user interface, we have an encapsulated image. It is an encapsulated image that is [] into a file that is transported as a an encapsulated object, and it is manipulated as an object, and you zoom into that object. It is an object whereas in a mapping system, your object is really the whole map system, whatever that is, and...

Boehm: It's the system application for that.

Utley: Right. What happens with the mapping system is the application will create mapped objects according to what you...

<End Side 1, Tape 1; begin Side 2, Tape 1.>

Utley: ...which are then handled individually as you need them or as you request them. What we're talking about is an encapsulated image which has all these attributes contained within that encapsulation.

Boehm: And that would be true whether or not it's on a hard drive?

Utley: Right.

Boehm: I guess that's right...yeah.

Bernstein: And then, so we are striking downloading and additional data over the network connection.

Utley: Prior Art doesn't need that either.

Bernstein: Prior Art doesn't need that. To do Yahoo!'s Map, you don't need a network and you don't need more data over that network. You see, you'd never beat this argument. A network is just a hard drive

because really in the end all you've done is like added a cable to your hard drive, and all you're talking about is the length of that cable, really. So networks are not applicable really to what we do. They are an added-value benefit that we can get through that cable quicker or whatever, but they are not the key. The network could be considered the cable between your hard drive and the display. You know what I mean, Brian? We don't need any...

Utley: No, but what you want to do is you want to make sure that you specifically address a network environment.

Bernstein: I wholly agree.

Utley: In addition. You absolutely want to make sure that the...

Bernstein: That's huge, as an additional wire, meaning it's got different...

Utley: Then that's the way to approach it.

Bernstein: Okay. You follow that, Doug?

Boehm: No. Slow it down.

Bernstein: Okay, it's all based on this. You can do our invention off a hard drive, and it's still cool. The fact that you can transmit it over a fat pipe or a small pipe or FedEx it has no bearing. It does what Brian says: it is more valuable in a network environment because it now has the attributes to give greater, richer data that you didn't think was possible in the shorter time. In the end, you see the network and the limited bandwidth, that never mattered because no matter, let's say your pipe was a toothpick, it would get there by tomorrow. Let's say your pipe is a direct line to the hard drive that's able to suck it up at 10,000 RPM or whatever...what's the term?

Boehm: RPM, yeah.

Bernstein: What's the term? Not RPM.

Boehm: Bits per second or...

Utley: BPMs.

Bernstein: Is that what you talk about a hard drive?

Utley: Well, RPMs.

Bernstein: Is it?

Utley: Well, yeah. Technically.

Boehm: The data transfer rate...

Bernstein: Yeah, I'm talking about how fast you can access your hard drive as a number that you buy hard drives based on 7200...

Utley: Oh, no, you buy millisecond access time.

Bernstein: Okay. So we're now 20 years into the future, and Brian invented a pipe that can suck down that speed he just said—hard drive speed. Well, there's no difference now, is there?

Boehm: Sell me on the concept that there's no difference between one hard drive and a network, and you're going to put the whole network industry out of business if you go there.

Bernstein: No, no, because it's a cabling system.

Boehm: I know, but...

Bernstein: It's just an accessed tour drive.

Boehm: And I think your point, and I think we've been there, that we're going to try and claim the broadest embodiment of your invention to be independent of any network or any hard drive or any...

Bernstein: And Prior Art also doesn't need any downloads or any networks. Prior Art, you can do Yahoo! zoom and pan, and Jim Armstrong just said it a minute ago, "I have it on my hard drive." And the program still operates by moving and grabbing this additional data. It has no network attached to it. He's doing it off his hard drive on a CD.

Utley: I thought we already covered that.

Bernstein: Well, I'm just saying one drawback of this type of system is that...and what it should say, if you want, is one drawback of this type of system in a network environment...

Boehm: I'd be happy to say that, but that says that over the network connection. The whole paragraph is to describe another example of prior systems.

Bernstein: But those prior systems don't require networks.

Armstrong: Let me suggest that...

Utley: Wait a minute, wait a minute. Come on. The first sentence says, "...over websites."

Bernstein: But all I'm saying is it doesn't have to.

Utley: Well, it's describing Prior Art, and this particular example is over Web sites.

Bernstein: Ah, versus Web CDs?

Utley: Yeah.

Bernstein: Or Jim's Yahoo! CD.

Bernstein: Okay, then I understand one example.

Boehm: And that's where we're going with the background. We're spinning our wheels here. Now if you want to add that to clarify, that's fine; but I don't want you to take away the distinguishing features that you have over networks because you may have to go run there some day.

Bernstein: Then do what Brian said: add it as an additional factor.

Boehm: Absolutely, but I guarantee you're going to have to argue this when we go to the foreign countries, like at the European office examiner, they're going to be really mean and nasty. I will bet you that they will find some very, very close art, and we will have to be throwing in all kinds...and my guess is that we're going to have to be throwing in all kinds of words that will have to be supported in the spec now to come up with something to survive a European examination if they find anything close, if we're not right that this is totally a broad concept. I'm just trying to...

Bernstein: Okay.

Boehm: We have to have a direction to run, and I need the ammo to do that; and I can't run to the network argument if you've either taken it out...

Bernstein: No, we're not taking it out, we're just...

Boehm: Or just minimized it.

Bernstein: We're not minimizing it. We're just saying you don't need it, but in that environment, it is also added value.

Utley: Let me point out one other thing why it's important...even more so. If you take the implementation like a Zif X, if it's local on your local system on your hard drive, you wouldn't care whether when you pan you reconstruct the piece that you're moving to.

Bernstein: Sure, that's different from what we do.

Utley: Because it moves very quickly.

Bernstein: But it still looks different from what we do.

Utley: But I'm not talking about that. I'm talking about when you move the magnifier, you reconstruct the

piece that's coming into the window, but you would never see that. But over the network where you have elements which extend the response time of the system, it becomes a big deal, and therefore what you've got becomes more valuable...even more valuable over a network.

Bernstein: That's what I'm saying. Okay, I agree with that. So we're all hip on that.

Boehm: I think so.

Bernstein: Okay.

Bernstein: All right, let's move on.

Boehm: Where were we?

Bernstein: We're on page...

Boehm: Three, right?

Bernstein: We're through page 3. We're onto page 4.

Armstrong: Oh, and by the way, we also had a change on 21, if you noticed.

Boehm: Okay, let me run over the changes on page 3. <Reading out loud> "...additional map data" should read just "additional new images and sends it over..," that would be fine with me. Oh, how about "additional data as additional new images"?

Bernstein: "Additional source material"?

Boehm: That would be...

Bernstein: "Additional source data..."

Boehm: "...as additional map images"?

Bernstein: Yeah.

Armstrong: I don't think you need "new images." I think just "source data."

Boehm: But it's really getting a new image. It's getting a new map. You're looking to the file. You're going back every time.

Bernstein: Okay, "additional source data." Well, ours goes back and grabs more source data, too.

Boehm: Exactly. But we've got to be careful. But we're not going getting additional new images. I may have to argue that, so you've got to have that in there.

Bernstein: Yeah, okay.

Boehm: "...retrieves additional source data..." how about ", e.g., additional new map images"?

Bernstein: Right. That's fine.

Boehm: Okay, "...and sends it to the user computer." Wonderful. Okay. Next change. <Reading out loud.>

Bernstein: We already dealt with that.

Boehm: So what do I do? Scratch it? Do I leave it in there, or what do I do?

Bernstein: Well, that's just saying our stuff, so you're still talking about the prior stuff.

Boehm: We're talking prior art.

Bernstein: Okay, so that's scratched.

Boehm: Okay. Next comment...

Bernstein: And that, again, scratch that one.

Boehm: Okay.

Bernstein: Because we're talking Prior Art here.

Boehm: I'm setting up the strawman, but now we're starting to knock him down.

Bernstein: Okay. Also, "there's a need for a system and method for providing a digital image suitable for

sufficient file transfers." I don't care if it's hi, low, medium.

Utley: On 21.

Bernstein: 21.

Boehm: It says...I just think that "high-speed file transfers" is a pretty good term of art.

Bernstein: Well, but then somebody will say, "Is that high-speed cable or modem?"

Boehm: Oh, I see what you're saying.

Bernstein: Efficient.

Boehm: Higher speed?

Bernstein: No, we don't care about speed. You could do it at 2400 baud.

Boehm: We don't care. Whether...

Bernstein: The other system didn't care either.

Boehm: Okay, that's fine. I'll leave it, then get rid of high...

Bernstein: You're just stuck with whatever speed the guy's got.

Boehm: <Reading out loud.>..."to engage in long and slow conventional continuous file downloads..."

Armstrong: And that's fine.

Boehm: What's a continuous file versus a regular file?

Armstrong: Get rid of continuous. You don't need it.

Bernstein: Yeah, you don't. What we were trying to say is that additional data there, but we've already got that.

Boehm: As long as...yeah. And that's why I need that language up top to say, "...additional data,"

"additional new images..." Somewhere where I can go argue that this is what we meant, and that's what the Prior Art does. Okay. Whew! What's on the bottom?

Armstrong: What we've been talking about. It's all we just discussed.

Bernstein: Forget the top comment.

Boehm: I can't really...it's cut off at the top.

Bernstein: That's fine. It's not relevant here.

Boehm: Okay.

Bernstein: "At least twice greater than..."

Boehm: "At least greater than..." that's good.

Armstrong: Not "at least," just "an image size greater than..."

Bernstein: Right.

Boehm: Yeah, duh! Okay. <Laughter> I'll tell you why I'm kind of groggy here now, later.

Bernstein: We were groggy, too. We were doing pans 'til 4:00.

Boehm: Til 4:00?

Bernstein: Yes.

Boehm: And then...so how many hours sleep did you get?

Bernstein: None.

Armstrong: Four.

Bernstein: Well, Jim got four. I got none.

Boehm: Okay, I got ya beat. You got none?

Bernstein: No.

Boehm: I spent the night at O'Hare.

Bernstein: Oh! That's my favorite place to sleep on a bench.

Boehm: On the bench. You got it!

Bernstein: I've been there a bunch of times!

Boehm: Yep, I hear you. I think Doug's black cloud follows him when he travels. Every plane I got on was delayed or broken!

Bernstein: It just follows the travel industry.

Utley: You should have rented a car and driven home.

Bernstein: I almost...I was thinking about that, but I was worried about falling asleep too.

Armstrong: So we're into line 15, 16.

Boehm: Okay, and that's the one that's scratched.

Bernstein: No, and 15 I would say, "The enhanced digital image file replayed on a client viewing device..."

Armstrong: "...displayed on a client's display system."

Bernstein: Yeah. The viewing window having a pre-determined franchise.

Boehm: Do that again. On line 15...

Armstrong: "The enhanced digital image file is displayed on a client's displaying system..."

Boehm: Instead of just...

Bernstein: "...downloadable..."

Boehm: Oh, I see. "...is displayed." I'm sorry, the same sentence is up above. "...is displayed..."

Armstrong: "...on a client's display system, the viewing window..." and then the rest is fine. And then

line 22, get rid of "at least two" and create "greater than."

Bernstein: Where?

Armstrong: Line 22: "...a magnification factor greater than..." Wait, what does it say. Hold on. <Reading out loud.> "...a magnification factor..."

Boehm: Oh, "...a magnification factor of at least two..."

Bernstein: No, "...greater than one."

Boehm: Okay.

Armstrong: "...greater than one without pixilization."

Bernstein: We don't mean without pixilization. No...

Armstrong: Yeah, that's right. It should be, "...a magnification factor greater than one." We haven't yet, I don't believe, defined a magnification factor yet, though.

Boehm: No.

Armstrong: It comes later.

Utlely: It comes later, yes.

Bernstein: And you can use, where I was telling you, Doug, where it was built onto a frame size, so therefore there's not additional data to draw from, therefore your zoom is zoomed to expanding the fixed pixel set.

Armstrong: And the next sentence, "The enhanced digital file further includes control data to allow the user to control the magnification factor." The question we had here was it seems as though we might be talking about the applet here.

Boehm: Yes, we're talking about the applet.

Bernstein: Then it's two different files.

Utlely: Yeah, but...

Boehm: Yeah, but the file...oh, I see, we're calling the enhanced digital image file the encapsulated [sloping? full thing?].

Bernstein: Yeah, and there are two separate files that go to the user.

Utlely: But it's encapsulated. It's actually [copied]. They always travel together.

Bernstein: They travel together, separately.

Utlely: Right. Then we shift.

Armstrong: They travel together, but they are two separate files.

Bernstein: Virtually, it's one, but really it's two.

Utlely: And associated with each other.

Armstrong: But we're calling it "the enhanced digital image file," but that's not necessarily true, Brian?

Bernstein: No, he's saying...here's what the story is, Doug. You got one file above an image, and there's not a single drop of other data in that file. It's called a .JPG...we use it. There's also a file...there's two or three files actually that get downloaded to the computer—or he has it on his system already, it doesn't matter to us—that allow him to zoom and pan.

Armstrong: And those are transmitted simultaneously.

Utlely: There is additional data that is required, whether you have a plug-in or not.

Armstrong: Really?

Utlely: A plug-in by itself has no information relative to the size of the image, to the number of steps you're going to take to drive into it.

Armstrong: But that's all built in...

Utley: There's another file, like an index file.

Bernstein: Oh, there is. Okay.

Utley: That's what I'm saying.

Bernstein: Okay. I gotcha. The person could have pieces of the file, like the applet, already on his system. But what Brian's saying is there's control data that goes with the image that was based on the image specs that then tells that interface to operate according to a set of assumptions. Right, Brian?

Boehm: Okay. I agree with you. I think what we're...

Bernstein: No, not within the .JPG file. You've got to be very careful. So we're not talking the same thing. Those are additional files.

Bernstein: Okay. Look at page 24, claim 1. "A method of dividing a digital image file comprising two elements, a digital image file...having an image file..." and "2. A user interface for the digital image file."

Bernstein: But we don't have to provide that. That could already be on his system.

Boehm: Oh, my gosh.

Bernstein: He has to have one to view the image; we don't have to provide it.

Utley: But he has to have the control data.

Bernstein: He has to have the control data to tell him how to view the picture, and that could one day be part of the .JPG file, I don't know. But today how we do it is as three separate pieces: an applet, a control file that tells him certain things about the .JPG, and a .JPG. Those things come packaged together. Now, a guy might already

have the applet on his machine; therefore, I don't need to send him that packet—the user interface.

Armstrong: If that's true, don't we send it anyway?

Bernstein: No.

Armstrong: We don't?

Utley: We do.

Bernstein: We don't have to, but like...

Utley: We always do.

Boehm: But that doesn't matter with your infringer. That's how you have to think when we're talking about the claims.

Bernstein: What do you mean?

Boehm: Would the infringer on your patent send it?

Bernstein: No.

Boehm: No, he'd send it to you once on the hard drive...

Bernstein: He'd Fed-ex it to you, and then not...

Boehm: He'd start sending you images, and each time he wouldn't be sending...but each time you would be sending some kind of control data?

Armstrong: Yeah.

Boehm: That's what I'm thinking, and that could be interpreted as the second element of the claim here.

Utley: And that control data really controls the motion of the zooming and panning.

Boehm: Right.

Bernstein: But that could even lie technically on his computer.

Boehm: Right.

Utley: The only case where that would actually work is if you knew that the...

Bernstein: The size of the .JPG.

Utley: The size of the .JPG and the size of the window.

Bernstein: And that could be for medical imaging where they give you the specs and say send me every image of this size, you don't have to send every single little thing.

Utley: If that was the only kind of image that everyone wanted.

Bernstein: Okay, we're doing x-rays. There's an X, Y, and Z size; here's our frame size; we never need to get that control data from you because it's built in.

Utley: <Inaudible comment.>

Bernstein: Okay, but let's say we're dealing with a bone doctor who takes strictly legs, and it's always the same. I'm just giving you the case.

Utley: I know, I'd <Inaudible comment.>

Bernstein: Right, and I don't want to get around that.

Utley: The fact that there's radiography is a little bit more than one image size. Theoretically, you're right. You could find an application where there's one and only one image size, then you could put everything in the system.

Bernstein: A size.

Armstrong: MRI always have the same size, don't they?

Bernstein: Right—2'x2'.

Boehm: We thought we had this one nailed down.

Armstrong: In MRIs you also...

Bernstein: You did have it nailed. We're missing...you just want to say "optionally provided."

Boehm: You can't use the word "optionally" in the claim.

Bernstein: We'll change that rule.

Boehm: No you won't. What we'll do is isn't the user interface provided from somewhere...we don't say where it's provided.

Bernstein: It could be any of four hundred of them.

Boehm: It could be provided from his hard drive.

Bernstein: Absolutely. It could be provided from somebody else's hard drive through a network.

Boehm: Exactly. That's why this covers it because the word "providing" is so broad it doesn't mean that we're sending it. See, we're providing a file...the digital image..we're fine.

Bernstein: Okay, I see exactly what you just said.

Boehm: We're providing a file for viewing.

Bernstein: Totally. I totally understand. Well, now we might not be providing the user interface...

Armstrong: Yeah, this still reads that it is "...a method comprising the providing of..."

Boehm: Yeah, you might be doing only step A at a time.

Bernstein: Yeah.

Boehm: Oh, damn. Okay.

Bernstein: Oh, yeah.

Boehm: Okay, that's a good...let's...boy. Let me think about that. What I want to do is make the element A that you're providing a digital image file having this and that, and you're also having control data to work with the user interface for the digital image.

Bernstein: But you might not need the control data. That's what I just said to Brian. What if a client says to you every one of my images is going to be a 2'x 2', and I want 50 time magnification. You never have to give him control data, you just have to...

Boehm: If we make the second part, B, a dependent claim. We can try it.

Bernstein: Do you see what we're saying?

Boehm: Yeah, absolutely. We don't...

Bernstein: And we don't want somebody to get around this.

Boehm: Absolutely. Great broadening work here. We've been through this claim, I thought we had it, everybody agreed to it! And that's where I'm going to run into a problem. I can't re-write this from scratch and get it on file today from working at half-speed here, you know what I mean?

Bernstein: Yeah, we've got to change that, though.

Boehm: These claims are not final.

Bernstein: No, I know, I know.

Boehm: We can file the claims as-is without one word. What we need to do is correct and amplify the specification because we can never add to the specification and keep the same priority date. I can go change the wording of the claims as long as that wording and explanation and interpretation is in the spec.

Bernstein: Okay.

Boehm: So I agree with you. This should be a dependent claim for the bottom half of claim one.

Bernstein: He's going to make that dependent because we don't have to do it but we do.

Boehm: Right. That's how you do optional.

Bernstein: Yeah. I like that. And then claim 1.

Boehm: Now does that read on the Prior Art? You provide a digital image file, having an image...

Bernstein: No, that's the invention right there.

Boehm: Right.

Bernstein: That if you ever looked at what I did back there, it was create a bigger picture for a small frame.

Armstrong: Now if we circle back to where this started on page 4, in the last sentence, that refers to "a digital image file, including control data," which is not correct.

Bernstein: Where?

Armstrong: The last sentence of page 4. It's not "the enhanced digital image file" that provides that, it's an additional option file...

Bernstein: Element.

Armstrong: Right...that would provide that.

Boehm: Okay. This is the summary. I can throw the word "optional" in here. So the "enhanced digital image file A..."

Armstrong: "...may be accompanied by..."

Boehm: I think just "...may further include..." most of the time, right?

Armstrong: Well, no, the file itself won't. It may be accompanied by additional files.

Bernstein: It could be in the file. We don't know. One day you could write [] that has a header inside it that says, "Here's your information." all bundled into...

Armstrong: But this is an exemplary embodiment, which means that today the enhanced digital image file may be accompanied by an additional file which...

Boehm: How about "associated with"?

Armstrong: That's fine, I think. Brian? "Associated with an additional file containing control data."

Utley: I think you should have a very general statement which will always be true, and then you could say, "The enhanced digital image file is associated with control data which allows the user to control the magnification factor."

Armstrong: And the control data...

Bernstein: That absolutely always has to be there, Brian.

Utley: Yeah, okay.

Armstrong: Otherwise you don't have our invention, so that's the right answer. Did you hear that, Doug? "The enhanced digital image file is associated with control data," and that's the only change right there. Strike "further includes" and replace it with...

Boehm: But I thought you said that once you've associated the first one, you never have to associate the rest of them.

Armstrong: When we said the associated was something that was on the hard drive, so we don't necessarily send it, but it will continue to be associated.

Boehm: Okay, okay.

Utley: Yeah, it's always associated. The data always has to be there to prevent zooming and panning.

Bernstein: Right, whether it's in the file, out of the file, with three files, nine files, however the hell you want.

Armstrong: So it will finally read, "The enhanced digital image file is associated with control data."

Bernstein: Hold it. "The enhanced digital image file is associated with control data to allow the user to..."

Armstrong: So "is associated with" replaces the two words "further includes".

Bernstein: Beautiful.

<Inaudible comments.>

Boehm: The rest of this is just comments?

Armstrong: Just on this page, and actually we struck this...5, we struck that. You have to put digital later.

Boehm: I'm still on page 4, guys. With the comments on the bottom, can I scratch them?

Armstrong: No, we took care of that.

Boehm: Yes, I think we've discussed this.

Bernstein: No, that seamless zoom, I love that word because everybody else isn't a seamless zoom, we are. We seamlessly zoom around an image. Everybody else has to grab and give you another frame and stop you and you have to remove to a different image in the picture. We're seamless. You can just go around and move and go, and it's in a virtual environment really.

Boehm: Now is not the place.

Bernstein: No, I know. I just want you to know.

Boehm: We can if you want.

Bernstein: No.

Boehm: "Seamless..." I like that. Let's...

Utley: Seamless may mean continuous motion and zooming is a step procedure. There's steps.

Bernstein: That's true.

Armstrong: It's not seamless.

Utley: The panning is seamless, but the zooming is not.

Bernstein: Right.

Boehm: But, in fact, what I'm trying to get at is Eliot is trying to claim and describe the invention in terms of what the user sees, which is great. As long as you can come up with good words and descriptions, we'll throw that in because we may have to run there if our technical description, which is what I've been trying to do to define the boundaries, fall because some bozo did this before and didn't really make it very public because he didn't know what the hell he was doing. We may have to say, "Oh, yeah, but try putting it on his. It doesn't do what ours does even though we couldn't figure out technically distinguish it in our..."

Bernstein: Right. It was a brand new phenomenon that was hard to...

Boehm: But in order to argue that, I have to have your concept of seamless zooming.

Bernstein: Well, let's use Brian's. It's seamless pan and...what kind of zoom? Continual? Flowing zoom?

Boehm: It appears to be seamlessly zooming...what do you mean "seamlessly zooming"? Do you mean panning?

Armstrong: Both. Both happen seamlessly in ours. When you increase your Adobe picture, you move in and grab a new frame of reference basically at that stage.

You're kind of stuck there. In ours, you're not. You can seamlessly...you know what I mean? You can drive further and further and still have the rest of the peripheral view. When you do Adobe, the magnification...is that true, Brian? No? Because when you pull in the painting and you've got the signature... you see, it's not describing what I want to say, the seamless for zoom. It is for pan.

Boehm: The seamless zoom, right. The seamless panning, I like that.

Bernstein: But the zoom is different in look.

Boehm: I agree. Now how do we describe your zoom versus Adobe or...?

Armstrong: Why do you feel different when you zoom in our picture than when you put some magnification in Adobe?

Bernstein: It's not seamless, is it? It's fluid.

Boehm: I don't feel any different. Sorry, Eliot!
<Laughter> The only difference that I feel is that I know I'm going to end up pixelating yours and all bitmapped images, whereas I know I'm not going to end up pixelating, I'm going to hit a brick wall, but it's going to be a clean brick wall, for Adobe, and that is...

Bernstein: No, it feels different. You're 100% wrong because you will be the only guy I've shown this to that's said that. Everybody found it unique and everybody who I showed it to said Adobe.

Boehm: For viewing an Adobe vector-based file?

Bernstein: Or a Corel pixel-based file.

Boehm: No, pixel based I'll give you, but yours is different. But when you're talking vector based, I think you can zoom vectors until the cows come home without pixelating.

Bernstein: But you can't...the perspective is different. When you take Adobe and zoom in on the image, you drive straight down to one point and then have to somehow have to move differently to get to other points than you do in ours.

Boehm: Yeah, generally you have to back up.

Bernstein: Right, or something.

Boehm: Zoom and then to go find out where the hell you are. But that's not always the case either, right Brian? Like Adobe PhotoShop or other...

Bernstein: No, I've been using all of these, and it's always been different. Our technique is different than all those. I've been using graphics programs.

Boehm: Yeah, I know, and haven't you seen a graphics program that shows you where you're zooming? I know what it is! On Adobe IV, when you zoom, the left window when you have it there with the bookmarks, it'll show you where you're zooming.

Armstrong: It has the box around that area? Kind of a miniaturized photo of it?

Boehm: Exactly.

Armstrong: Yeah, I've seen that too.

Bernstein: But that's just trying to give you what we give you in a pre-pack...ours encompasses that without having to need that. See, there's a difference that every engineer in graphics that's ever seen that has said "cool," not "oh, I can go over in Adobe and move around images."

Boehm: That's why I wish I were an expert in this graphics area. I would have figured this out...the difference.

Bernstein: Well, now that you say you're not, I need somebody to step in who can because I think that we should file with what we have here, but this area needs to be absolute, not less kind of

vague. Because there is a critical difference. It is something that can be optically seen, so therefore it can be electrically defined.

Boehm: And we're trying to do that in the video side with Chris Taylor.

Bernstein: Maybe we do that with him on this. You want to ask him?

Boehm: I don't...he's going to have a kid this summer, and I think he's not even going to be around much in August.

Bernstein: Well, maybe he's got somebody.

Boehm: Yeah, maybe he knows of somebody.

Bernstein: Or go over to my old alumni at Madison, their graphics engineer.

Boehm: This is a...in order to protect our butts, we have to do that by September 1, and that's a big thing to do.

Bernstein: Why? I thought we could always go in and amend our claims on this stuff.

Boehm: You can amend the claims as long as it's supported in the spec. Now if we have to get down to the nitty-gritty of the definition of the technical excuse to amend your claims to distinguish over what has been done before...in other words, if we have to limit our claim to the histogram between a range of X frames per second and Y frames per second, that is our invention. If you incurred less than—I don't know what the histogram shows...17.6 frames per second—that is not our invention, and we may have to go there, to be that narrow to survive if somebody else has done it at 17.

Bernstein: Wow, wait a minute! I hope that's not correct because at lower bandwidth you might have only 17 frames, but you have greater data. But let's get to video later, right?

Boehm: But my point is that you want support in specification, including technical excuse language, because I made need that to put that in the claim to make your patent survive.

Bernstein: Well, let's put something in here that defines this.

Boehm: Yeah.

Bernstein: Something that defines the...

Boehm: But the point is that we can't hire a technical expert to get the...

Bernstein: Then let's get someone in then we'll get a technical expert to define later.

Boehm: If it's to be considered new subject matter...

Bernstein: No, it's never a new subject matter because the first image that did this, did this.

Boehm: No, no, no...new subject matter for the document on the day you file it. They don't care about what you did in your basement. The patent office doesn't care. They care about the words and figures that you put on this paper when you file it. That's all the patent office cares about. You can't go back...

Bernstein: That's not what you told Chris the other day. Chris said, "What happens with the Mom-and-Pop inventor who later discovers the equation to what they did?"

Boehm: Finding who was the first inventor, that's in an interference. The question isn't whether the patent's valid or not in the scope of your claims, the question then is was Mom and Pop doing it a year before the other guy? But if Mom and Pop didn't describe their invention in the spec, they will never get to an interference or the interference will be blown away because it didn't meet the rule that you have to clearly and distinctly and accurately describe the invention.

Bernstein: Well, we clearly describe it, but we might not know the technical underpinnings, and I've got to go recheck my notes, but I think that's exactly what Chris Wheeler asked you.

Boehm: Absolutely, and I agree with you. We don't need to know the reason why.

Bernstein: But later we can put it in?

Boehm: If it does not add new subject matter.

Bernstein: But this wouldn't be new subject matter, this would just be an explanation of why.

Boehm: Yeah, but if we're up in the fog right now and we are using words that are so broad...let's say our claim said, "Our zoom and pan works really neat." That's our claim. There's no way we're going to be able to go back and say it really means having a frame rate between 30 and...

Bernstein: Then you know what? Put in the word "seamlessly" because I'll be able to argue that until the cows come home that there's a difference between what we do and what they do, and somebody will argue out what seamless meant.

Boehm: You won't get the chance to argue. If we put the word "seamlessly" in the claim and it's not supported in the spec, the court will determine by itself without ever talking to you what it thinks "seamlessly" is.

Armstrong: Do we have to then, in order to cover this particular issue, do we have to get into a description of Prior Art and the standard by which zooming and panning is occurring in Prior Art, and then distinguish as clearly as possible in words, how ours is differentiated from it?

Boehm: That's the ideal way to do it, Jim. That's why I'm saying, and if all of us knew that technical underpinnings, this would be a much more [] written document...

Armstrong: Is it necessary, Doug, to describe it in terms of technical underpinnings, or can we describe it in terms of a user's observation?

Boehm: You're halfway there. "User's observations" would probably give us sufficient...

Utley: "...allows you to seamlessly pan..." and all the <inaudible comment>

Boehm: The claim will be interpreted by the spec.

Bernstein: That's true. <Responding to Utley above.>

Utley: Now the only differentiation is the zoom without pixelating.

Bernstein: Okay. I'll agree with that.

Boehm: And then you saw that I went to umpteen degrees to define what the hell pixelation was because that's a word in my claim. Do you see that?

Bernstein: Yeah, that's fine, and I'm going to concede on that because Brian just made a good point.

<Everyone talking at once.>

Boehm: Because [] will know the reason why in terms of [], but you do have to know enough about what you're doing in order to convey to the average person skilled in the art so he can make and use it and he understands just what the hell it is.

Bernstein: You see, Brian, that's my question now. That comes back to what's different between our zoom without pixelating versus theirs, but we've already described it in the way we built the frame.

Utley: Right.

Bernstein: That's the difference.

Armstrong: Okay, let's stick with that.

Utley: No, we bounded how you prevent pixelation.

Bernstein: Okay, then that's the key.

Utley: We totally bounded it.

Boehm: Okay, I'm lost now.

Bernstein: We're fine.

Boehm: ..."Seamlessly..."

Bernstein: Forget "seamlessly."

Boehm: Okay.

Armstrong: Page 6...we're off of 6.

Bernstein: No, on page 5, I only had one more question. Figure 2, just print film is what it's showing...it can be digital, and we talk about that later, correct?

Utley: We separate it now.

Bernstein: That's where I'm confused.

Armstrong: Page 6, "24 to 32-mm lenses.."

Bernstein: Why? We can use any lens.

Boehm: It's a "such as"...it's an example.

Armstrong: Okay.

Bernstein: As long as it includes every lens.

Boehm: Oh, sure.

Bernstein: Okay.

Boehm: And it says, "may include," but then if we ever needed...you see the reason we get so specific on this, Eliot, is because if somebody else just happens to be doing it out there in the world with a 2mm lens and it doesn't haven anything to do...it doesn't come out looking like yours at

all, but it just so happens our claim reads on what the hell he was doing, we can come back and say, "Oh, no, that's not really what we were doing. We really meant this; and if this is important enough, we'll put the words '24 to 32 mm' as a dependent claim."

Bernstein: But it's any lens, isn't it?

Boehm: Yeah. My point is if this 24-32 means anything...

Bernstein: But we can still say any? We are saying "any," but we've defined something.

Boehm: If that was your preferred embodiment, that's the other reason.

Bernstein: Okay, that's fine.

Boehm: It's not limiting.

Armstrong: As long as it's not limiting.

Bernstein: And then "the image of a scene..."

Armstrong: On 10.

Bernstein: Just strike it...."of a scene."

Boehm: Okay.

Bernstein: "...has utilized an image which is being photographed."

Boehm: Okay.

Bernstein: And then you see "The image may be a print film image, analog image, digital image, negative, TV signals..." Can that be, Brian?

Utley: No,

Bernstein: No? "The camera captures shoot.."

Utley: Well, yes, you can use TV signals to create an image, but you can't enlarge TV signals.

Bernstein: Okay.

Utley: But you can use TV signals to get an image.

Bernstein: Okay.

Boehm: Isn't an image just broader than that? It's what the eye perceives; and once it's digitized, then it's a signal...or it's analogized, once it's captured in some format. So an image isn't really captured. It's a captured image when it's analog or digital or negative or film or something, right?

Bernstein: Um, hum.

Boehm: So a TV signal is already captured.

Bernstein: Gotcha. Okay.

Boehm: So what I'm saying here is the image...that the camera is utilized to do the capture.

Bernstein: I've got you. I'm set with that point, actually. Okay?

Boehm: And again, this isn't really...as long as you're best-moded in there, we're fine. And we shouldn't use the wishy-washy language "may be." That's not restrictive.

Armstrong: In line 20, we inserted the word "may" only because it also may not include a developing device.

Boehm: That's fine. The next sentence says that, though.

Armstrong: Oh, it does?

Bernstein: Jim, I noticed that after the "may" came in. And we definitely talked about a digital file, although...

Boehm: Then should we leave the "may" out? Because it will include some...you've got to develop print. I think he was right.

Bernstein: Well, what if it did it all on one system?

Utley: Well, it doesn't matter. It's still developed. Like a Polaroid.

Bernstein: That's what I was thinking was Polaroid.

Utley: That's what I thought, but it does have a developing device.

Bernstein: Yeah, actual images developing device.

Utley: Well, it's self contained.

Bernstein: Right, but it's still...

Utley: Part of the film.

Bernstein: And it's still developing it.

Boehm: I think you better leave the word "may" out.

Bernstein: Yeah, that's what we're talking about. Now my bottom comment is wrong here, but it definitely comes in when we describe a digital image because I'm completely confused by some of the logic there.

Boehm: Where? At the bottom of the page?

Bernstein: Yeah. On a digital image, when we size it, we say we don't make a bigger target frame than we have sourcing for.

Utley: Because as soon as you do, you introduce pixelation.

Boehm: You don't want to enlarge anything unless it's not been digitized yet.

<Everyone talking at once.>

Armstrong: It's part of the shooting.

Utley: A digital image is a digital image. It has pixels, and it has a height and a width.

Bernstein: And it's just placing them all in the frame.

Utley: You see, you place it into...

Bernstein: We've gone over all the developing and scanning and art frame, Brian. Right, by picking "I want my limiting size to be four football fields.

Boehm: Exactly! Now you've got the...[] source image. <Everyone talking at once.> But you don't...usually you don't enlarge that because if you do...

Bernstein: You start pixelating...

Boehm: ...pixelating, and that's...

Utley: Because you're enlarging pixels.

Armstrong: We just create it large, we don't create it small and enlarge it.

Bernstein: But we don't create it to fit the frame, we create it to blow away the frame.

Boehm: Am I understanding correct, though, that you never enlarge a digital image before you process it? That's not a step for a digital image. You only enlarge a print-film image, correct?

Utley: Right.

Bernstein: But what you do do is set...

Armstrong: Set your...the image that you're taking, your target image, add a size so that when it is taken, it is already at a size that exceeds the view window.

Boehm: I see what you're saying, but I don't call that enlarging, I guess.

Bernstein: Okay.

Boehm: Good, good.

Armstrong: Okay.

Bernstein: But let's make this clear because I don't understand it still within the verbiage that's here.

Boehm: Okay, what line?

Bernstein: Well, we'll get to it. That's why I said it's there because I started to get confused, and then later we'll get into it...into the mathematics of it. Just wanted you to be aware of that.

Utley: Okay, page 7.

Armstrong: Page 7...

Boehm: I'm sorry, I want to back up. Did he get into the enlarger? The only enlarging is on page 6, line 24. "System can also include [] 16 for enlarging the image which is developed by developing ..."

Bernstein: Yeah, that's fine.

Boehm: 99.9% of the time, this is going to be a photographic enlarging device.

Armstrong: Right.

Boehm: Right?

Bernstein: Yeah.

Boehm: You may have to use that word someday. I've got to have it in here.

Bernstein: Okay, yeah, because we wouldn't call it a "pixel-enlarging device."

Boehm: Exactly. "...the image may be photographically enlarged from a print film image," okay?

Utley: We said earlier "non-digital image source," in this section, did we not?

Boehm: Yeah. I just want to get the word "photographically" in there.

Armstrong: Okay.

Bernstein: Yeah, and then...

Boehm: "...be photographically enlarged..."

Bernstein: Well, it doesn't have to be photograph. Is it negative of a photograph...?

Boehm: Okay, what's the word then? I think it is.

Utley: Yes, it is.

Bernstein: Yeah, you would say enlarging a negative is a photographic enlargement.

Utley: It's your choice whether you enlarge it as a positive or a negative.

Boehm: What we're really talking is analog enlargement as opposed to digital.

Utley: Right.

Bernstein: Correct.

Utley: Optical and analog.

Boehm: Optical analog, yeah. "Optically enlarged"? No. Yeah. Well, photographically...

Utley: I wouldn't be restrictive...we'll, you don't have to be restrictive in that.

Boehm: Right. And photographically is generic.

Bernstein: Cool.

Armstrong: Page 7, line 19. The question here was just to clarify really more for Brian than anybody is are we able to take our digital image and, and I

think we talked about this earlier, but send it right to a set-top box or something else.

Utlely: Absolutely.

Armstrong: We don't say set-top box, and I think we said earlier set-top box presupposes that it includes a computer element within a set-top box.

Utlely: But Doug, we could externalize that. We could make it explicit that there'd be personal computer, laptop computer, so and so, and set-top box...we could include set-top box in that string of definitions.

Boehm: Right, and technically, this is a little bit goofy. The way we're supposed...and maybe he did it, I don't know, but the first time the number 22 appears in the spec, should be the definition. And the numbers, if you noticed, are in order. The number 10 is the first reference number; 12, 14...that's how you find the reference numbers in a well-drafted patent application.

Bernstein: Well, that confused the shit out of me. Where the 10 came from, why it was there...

Boehm: Well, you start at 10...look at page...and this isn't a big deal for you guys, but look at page 5. You want to go straight 10. System 10, boink! System 10 includes camera 12. We go on up 12, 14, 16, and on up.

Bernstein: Yeah, I followed that.

Boehm: So you never need to know where those reference numbers were defined. That's why you define them up front, and that's where he missed it because 22 hasn't been defined yet but he's using it—computer 22.

Armstrong: I first shows up in line 17?

Boehm: Exactly. So let's genericize that and define it later. <Reading out loud.> "Alternately, a

digital image may be provided from camera
12...may be provided directly..."

Armstrong: ..."to the user." In line 17.

Boehm: Um, hm.

Armstrong: "...to the user," and then the first reference is
in line 21, where we define computer 22. That's
fine.

Utley: That's good.

Armstrong: And then add to that "set-top box."

Boehm: Yeah, down below.

Bernstein: Or TV.

Boehm: Or whatever. We're getting there. Hang on. So
it's "...to the user via a communication link..."
I'm getting rid of "or cable" because again he
hasn't defined 23 yet. 23 will be defined later
because he hasn't even introduced 22 yet. That's
what happens when you edit a patent application.

Utley: Doug, how would you take care of the situation
where the set-top box may be integrated into the
display device?

Armstrong: I think that might be covered in the next thing,
where we say, "Computer 22 includes the CPU, a
ROM, a RAM, and a display device..."

Boehm: Exactly.

Armstrong: ..."or input device. It also may include any
hardware device, peripheral device, or software
necessary to perform the functions described
herein."

Utley: Right.

Boehm: Yep. I guess we're there.

Armstrong: That does get us through that.

Boehm: That's the function of computer 22. Processes the digital image file, correct?

Bernstein: Yeah.

Boehm: We're talking about figure 1 still, right? You've got the figures pulled out to the side like I do, right? Sure.

Bernstein: Sure.

Boehm: Yeah, you're supposed to because when you're reading this, you're supposed to have the...

Bernstein: Mine are so bent up, it's not that hard to get to.

Boehm: Usually the pages are so out of order, you can't find the figures anymore. So "System 10..." see the number 10?

Bernstein: Yeah.

Boehm: "...includes computer 22"—that's his box 22— "...configured to process computer image file created by the above-mentioned devices." That's the definite of 22. Now we...so it's a processing device, right?

Utley: Right.

Boehm: It processes...right, okay. "Computer 22 may be a personal computer, a laptop computer, a mini-computer, a microprocessor, mainframe computer..." He's going bonkers here..."a network computer..."

Bernstein: That's good. A set-top box?

Boehm: Yeah, we can throw "a set-top box" in there.

Bernstein: You want these words.

Boehm: A toaster in there if you want!

Bernstein: Yeah, a toaster with a display.

Boehm: Right, and a processor.

Armstrong: The following sentence kind of wraps it all up or anything Doug has.

Boehm: Okay, so where am I putting set-top box?

Bernstein: Under...

Armstrong: After one of those things...after...

Boehm: But we haven't shown NTD yet.

Bernstein: Yeah, but set-top box should be TV, too. Well, a set-top box plays through a TV...well, no, it doesn't have to.

Armstrong: Let's put set-top box after server computer...

Bernstein: And TV...or TV.

Utley: You said set-top box goes between...

Armstrong: The TV.

Bernstein: Or if it does what you said and the TV comes...

Utley: But we have to take care of the case where it's built into the...

Bernstein: Right. TV.

Utley: But then you depend on the CPU, the read-only memory, the RAM.

Armstrong: Does all that need to be in the TV?

Utley: Yeah.

Armstrong: Okay.

Boehm: My question is if you define computer, 22, as the thing...oh, my gosh, 22 isn't the user's...is this...

Bernstein: No, isn't that our computer?

Boehm: This is our computer. 26 is the user's computer and display and set-top box...I mean, 28 and 30, that's what I was thinking about. Where it says later in the next page, and say, if you look at the figure 1, 28 and 30, could be combined to be a set-top box or a TV or you name it.

Utley: Yeah, user computer.

Boehm: Or a toaster with a display.

Utley: Right.

Boehm: The point is, what is computer 22? That's the one that puts it on the Internet. That's your server.

Utley: Right.

Boehm: So you don't put the set-tops...

Utley: That's the one that processes the source image. It creates the file.

Boehm: It's the digital image file.

Utley: And it may be the server.

Boehm: It may be the server, but no matter what, it would be a computer. To put it on a hard drive or to put it on a CD ROM, right?

Utley: Right.

Boehm: That's what we're getting at here. It's the processor. It's the encoder, isn't it?

Utley: Yes.

Bernstein: Yes.

Boehm: So could it be a personal computer? Sure. It could be any of these he's got.

Bernstein: Yep.

Boehm: So, he's correct so far without changing.

Bernstein: Right.

Boehm: "Computer 22 includes a CPU, a ROM, a RAM, a display device, input device..." I would...he's defining it there. I would say, "...typically includes."

Bernstein: Yeah.

Boehm: Because it may be missing one of those.

Bernstein: Yeah, absolutely.

Boehm: "...typically includes..." blah, blah, blah. Good. "... computer. It may also include any other hardware device..."

Bernstein: That covers it all.

Utley: I've got to go back to page 7, because we made a change I don't think we should have.

Boehm: I'm still on 7.

Utley: Okay. Line 17. "Computer" is correct—we shouldn't put "user" there.

Boehm: You're absolutely right, but I can't call it computer 22 yet.

Utley: You're defining the processing unit.

Boehm: But the whole point of the paragraph is to say print film versus digital, and this print film is going to be enlarged and scanned. Alternatively, digital file is provided directly without first creating a print image. It doesn't matter where it's housed.

Utley: Right, just say that.

Bernstein: Let me ask you this. Did you ever create a case where the analog camera takes the pictures according to the right specs and puts them on the

film that way, or would you have to use larger film format?

Utley: No, you can't.

Bernstein: We can't go that way?

Utley: Well, but we do that with 4x5s and fill.

Bernstein: But it's still 4x5?

Utley: Right.

Bernstein: When you've shot the picture, it's 4x5. You can't tell the camera to shoot this 10 times bigger?

Utley: No, but what you do is you scan it at different density.

Bernstein: And that gets it the bigger...

Utley: That creates the...

Bernstein: That's where I'm probably getting confused on this digital image thing. Yeah.

Armstrong: What if you just moved...what if you left line 16 and 17 alone and just moved the whole paragraph, beginning with line 21, in front of that, where you defined computer 22 before it's used in that sentence in line 17?

Boehm: Because it doesn't really flow there. What you're trying to do in that paragraph, he's says, "If the images obtained are digital...", he's describing the printing device 20 there, and that has to be described...20 has to go before 22. That's where he's introducing what 20 is.

Armstrong: Yeah, although with line 15, the sentence starting with "alternatively," that actually does not talk about printing.

Boehm: Let me read it again. I think you're right. "...if the image is obtained with a digital camera, a print image may first be obtained..."

Armstrong: What he's saying, you took a digital picture and you want to print it and then enlarge it.

Boehm: Yeah, he sends it to a printer, 20. "In this manner, print image can then be enlarged and scanned."

Bernstein: Right. So even though you don't have to...

<End Side 2, Tape 1; begin Side 1, Tape 2>

Bernstein: Tape 2, Patent Meeting, Docket 57103-120. Let's start on page 12.

Boehm: Wherever you want to.

Armstrong: And I think a lot of this is going to be totally fixed up by this change that Brian's made, or this correction that he's made, but I just want to be certain of it.

Boehm: And I'm a lot colder on that, guys, than Steve was, so just do a dump on me, make me the corrections, and I'll just do it kind of cold without analyzing it; and then when I read it again tonight, I'll see if I can...

Armstrong: Okay, the first thing Brian, I just wanted to make sure what you meant here. You want that to be VWW?

Utley: No, VIH.

Armstrong: Or VWH?

Utley: It can be either one, but I want it to be BIH.

Armstrong: Okay, well then let's talk about it because then what we're doing in the first line of this page, we're saying, "The viewing image height and viewing image width within the viewing window can be determined by comparing the source and the aspect ratio of the viewing window application." So the unknowns are the height and the width of the viewing window.

Bernstein: Viewing image window.

Utlely: Why should you add aspect ratio? What it says if you compare the aspect ratios—you know what those are—

Armstrong: For the source and the viewing window.

Utlely: Right. If you know what the aspect ratios are, you all you need to know is determine whether you are going to use VWH as the basis or whether it's going to be VWW.

Armstrong: Okay, so let's just say in the first that the source image aspect ratio is greater than the viewing window aspect ratio.

Utlely: Right.

Armstrong: Then we're going to set the viewing image height equal to the viewing window height.

Utlely: Right.

Armstrong: And then the next line, in order to get the viewing image width, we need to divide the viewing image height, which we don't know.

Utlely: We do know.

Armstrong: Okay, tell me.

Utlely: That it's equal to VW and VWH.

Armstrong: Oh, okay. So we're really saying the same thing?

Utlely: Yeah.

Armstrong: Right, we're saying the same thing.

Utlely: Yeah, but this is mathematically correct.

Armstrong: Okay, so we are saying the same thing.

Boehm: How about grammatically, Brian?

Utley: Pardon?

Boehm: But I'm partially kidding on that, but when you use the phrase "target image size," go to...well, you don't have...

Utley: Let's come down...

Armstrong: Let's come down. Let's say if that's false.

Boehm: My question is the language. You say on line 23, 24..."a target image size TIS has a TIW and a TIH." Does that make sense to call the window a TIS or a VWS for size? It's the same concept—width times height equals something. You want to call it area? That's even clearer.

Utley: Yeah, size and area are interchangeable.

Boehm: Well, maybe we should say that the target image area—TIA. "Having a target image width times the height..." That's beautiful.

Utley: They're interchangeable, so it'll work either way.

Boehm: Okay.

Armstrong: Let's just continue.

Utley: Let's say we're defining size as area, size is total number of pixels, which is area.

Boehm: My only question would be can I make the...at the top of page 12 where you said, "...the viewing image height, gauge, and viewing image width (VIW) within the viewing window area..." VWA?

Bernstein: Yes, that would be very clear.

Boehm: Yeah. You're also consistent with the target image area, but am I doing the wrong thing here, Brian, because you used VW earlier. Are you using it consistently?

Utley: Yeah.

Armstrong: Yeah.

Utley: Yeah, it's consistent.

Armstrong: See, just continuing with my thought pattern in the [us?] statement, I would just reverse the order of these and put VIW.

Utley: It's right there.

Armstrong: Okay, okay.

Utley: So if you pick it up off the computer copies that I sent, it's correct.

Boehm: Oh, okay. Is that what he did? Just plugged it in?

Utley: Yeah, this is what I sent him last Thursday.

Boehm: I see.

Utley: I had written it. This is where it was transcribed.

Boehm: Okay, well clue me in where this started, Brian.

Utley: So you go down to...

Boehm: Is this page 11 on your sheet, or not?

Utley: Page 1 on the aging process.

Boehm: We're at page 11 of the text. The formula starts on figure 7.

Bernstein: Yeah, you've got to go back to 11 and start him at figure 7.

Boehm: Yeah, start me off here so I don't blow this.

Bernstein: Right, he wants to get every term.

Utley: Oh, okay. On page 11, we define the aspect ratio.

Boehm: Right, which is on page 1 of your new...

Utley: Right, got it.

Boehm: Okay, that's what I wasn't sure. Brian, you still want me to use his text because it looks like...

Utley: Yeah, his text is fine.

Boehm: Yeah, it looks like he added words to your...

Utley: Yeah, no, he expanded...

Boehm: He expanded to make it readable.

Utley: Right.

Boehm: I see what you're saying. But the formulas, let's go through each one of the formulas and make sure they're correct, right?

Armstrong: That's what I'd like to do now before I run out of time. Brian, down in...you're on 12?

Utley: Yeah, right.

Armstrong: On 12 when we, after line 25, when we start talk about these equations, the statement here I don't see as being expressed right. Now I could be wrong, but the $TIS = \text{the } TIW \text{ times the } TIH$, agreed; but that also equals VIS times the magnification factor.

Utley: That's correct.

Armstrong: When I re-do this formula, I understand that the magnification factor is VIS/TIS .

Utley: No. Not true. The magnification factor is TIS/VIS .

Armstrong: Actually I had it the other way- VIS/TIS .

Utley: TIS/VIS .

Armstrong: It's the ratio of the viewing image to the target image?

Utley: Right.

Armstrong: So it would be VIS/TIS.

Utley: What's the ratio?

Armstrong: It's got to be one over the other, so we express it right.

Utley: It's the TIS divided by the VIS.

Armstrong: Okay, let's go to line 19. Then this is stated wrong: "The magnification factor is defined as the ratio of the viewing image to the target image." So that needs to be reversed.

Boehm: Right, but that's word for word what you had on top of page...

Armstrong: So it's defined as the ratio of the target image to the viewing image. Okay, so those need to be reversed, in which case we've got $TIS/VIS = MF$. If I'm solving for TS, I've got $TS = VIS * MF$. Now you're right. So down below is fine.

Boehm: Yeah, because the target is going to generally greater than the viewing image window.

Bernstein: Yeah, I just couldn't reconcile the formulas because of that transposition, that's all.

Boehm: Brian, what are you ratioing? The size? The area?

Utley: You're ratioing the area.

Boehm: The area.

Armstrong: And I like that clarification because it's...

Boehm: Didn't we way it's the ratio of the areas, or of...you mean the ratio of the viewing image area to the target image area?

Utlely: Yeah, because when you magnify, you magnify an area. Magnification [is an aerial?] a function.

Boehm: Excellent.

Armstrong: So height time width is area, which would be good every time we referred to target image or viewing image, we called it viewing image area or target image area.

Utlely: Yeah. The only reason why I picked size instead of area is because we talk about aspect ratio, and you begin to use the A...the A shows up in a number of different forms, and therefore I didn't want to confuse you with A in one being A, aspect ration, being the same as A in area. That's the reason why I did that.

Armstrong: Okay.

Utlely: But we understand that area and size are synonymous.

Boehm: Let's just get rid of the A in aspects and make it SIR. That solves your problem, and then everything else is also...

Armstrong: That's right.

Boehm: ...three digits, right?

Utlely: That's okay because that would define aspect ratio as R.

Utlely: Yeah, that's fine.

Armstrong: And it goes on line 4 as well.

Utlely: Yeah, all the way through.

Armstrong: Again, Doug, just in the interest of time, I think what I'd like to do is apply the semantic changes to the text after we've made sure that some of my math questions...that Brian and I are on the same page before I have to leave.

Boehm: And I'm not even sure we'll have to do that because I have to go through it when I do the edits here, and I will do the same thing that you are doing and make sure it makes sense.

Armstrong: Okay. On the top of page 13, then, what I was able to determine from this and confirm with Brian is that the source image aspect ratio is equal to the target image aspect ratio. The question is was this intended because, and we started to have this conversation, is that we may not have...we may crop photographs, we may want to stretch a photograph...

Utley: Let me explain how that works. First of all, in the image sizing program, you have the ability to change the size of the source image from a standard image. In other words, if you are cropping, you can specify the crop, and it will give you the right dimensions and it will fit it into the viewing window. So a cropped image...

Armstrong: But it lost data. When you crop, don't you cut away a piece of data?

Utley: It's before you get data. It's while it's still an image.

Armstrong: So it just smushes it in right?

Utley: Yeah. It puts it into the viewing window properly. So you can specify a cropped image source without any problem. But the case that isn't covered yet...there are two cases that aren't covered yet. One is where you digitally crop an image, okay, which you can do. You can get there, but you have to know how to get there. The second is, we have not covered the case of the panorama or stitch images.

Bernstein: But it's all one image in the end.

Utley: I know, but we want to cover the case of the dimensions because it assumes that you always fit the image into the viewing window, but in the case of stitched images, you don't.

Bernstein: Why?

Utley: You let the...

Armstrong: The image flows beyond it.

Utley: The image flows beyond the edges of the viewing window.

Armstrong: It does?

Utley: Yeah.

Armstrong: When you first look at a Hyatt Hotel pool shot, you don't see the whole shot. You see one shot, and then you pan around it. So you're not fitting the whole image into the viewing window.

Utley: Right.

Bernstein: We never were. Prior Art does that.

Boehm: On a photo you are.

Armstrong: And a Prior Art also gave you the ability to do that.

Utley: Yeah.

Bernstein: But on a MAC standpoint, he's not creating that formula for fitting a panoramic image...

Armstrong: Into a viewing window because you don't do that.

Bernstein: Gotcha.

Boehm: What do you do in terms of actually doing the math, Brian?

Utley: When I get that built into the image sizing program, what it will do is it will size the panorama into the viewing window vertically, and then it will allow you to pan horizontally across the image.

Boehm: Or vice-versa.

Utley: Theoretically, yes, although we don't have any examples of that.

Boehm: What happens if you wanted to...well, panning bigger, if you want it bigger...

Bernstein: You could do what you're saying and pan vertically and horizontally, we just don't do it.

Utley: But if you did that, then what I'm saying is you size the image into the viewing window so always see one dimension completely until you start zooming.

Boehm: My suggestion is that we don't...of course, we're not going to worry about that today, we don't have the time to do that. When we get to the end of this, then we'll say, of course, when you stitch images together to do pick your pan, you would first do the small size, and then whatever.

Utley: Right.

Boehm: We'll just handle it because the point of this math is to give us a basis for putting technical definitions into the claims if we run into the problem that we need it during prosecution.

Utley: Not only that, but it's also very helpful when we're talking to...when we're doing due diligence and we're talking to people about how does it work. This is how we sit down with them and say here's how it works. This is not something that's off the seat of the pants. This is something that follows a disciplined structure.

Boehm: Absolutely, and that buys you credibility.

Utley: Right, and then when we license someone, this is part of the documentation.

Boehm: The biggest thing is is it the best mode? Remember, we have to disclose the best mode of making and using your invention.

Utley: Yeah, and this is the best mode.

Bernstein: This better than blowing up images.

Armstrong: Let me just further throw into this source image aspect ratio equaling the target image aspect ratio for a second. I've got just an example written on the side with those people in a box. If we start with the small image here, which is a 6x8, and we blow it up to an 8x10...that doesn't matter, we end up with a source image that's 4x5, and then we just make the target image 4x5, right?

Utley: Right.

Armstrong: So it's not that one is...because the little one is not the source image, it's the bigger one that's the source image after we've done the cropping.

Bernstein: No, that's the target image.

Armstrong: No, that's the source image that goes into the system. Then we create the target image.

Bernstein: No.

Armstrong: Yeah, this is before it goes in.

Utley: If the source image is, say, at 8x10, what the formula does is tell you how to scan it so that you arrive at the right target image. So if you go down further, it says, "And, by the way, if you follow the program, the program says the right scanned density for this is this many pixels per inch," and that will produce you a digital image which has a magnification factor...

Armstrong: That's the next step. I think I know the answer to this, but in this example, which of these two things is considered the source image?

Utley: The source image is the 8x6.

Armstrong: The target is the 8x10?

Boehm: We have to define that, guys.

Armstrong: Okay, hold on because we've got...let me just follow this math. I just want to understand why I'm wrong here. In the source image then, we have an aspect ratio of 3:4 on an 8x6.

Utley: Because it's a portrait.

Armstrong: It's a landscape.

Utley: Okay.

Armstrong: This is a picture of my kids on the beach, but I want to frame it in a portrait frame, so I'm going to go in and I'm going to crop the edges and turn it into an 8x10 and blow it up.

Utley: Where do you crop it?

Armstrong: I'm going to crop it on the scanning program, let's say. I've got a print image, and I'm going to throw it on the scanner. I'm going to throw this on the scanner. I'm going to crop the edges of, blow it up to an 8x10.

Utley: You don't do that on the scanner. You don't blow it up on the scanner.

Armstrong: Okay, well let's say then I blow it up on a...let's say I blow it up before I scan it.

Utley: Right.

Armstrong: And then I crop it. I end up with an 8x10, which is an aspect ratio of 4:5.

Utley: Right. It's not portrait.

Armstrong: It's not portrait?

Utley: Right. 5x4.

Armstrong: Exactly, right, 5x4. I did that backwards. So now I've got...

Utley: An aspect ratio of 1.25.

Armstrong: Right, I've got a three-quarter aspect ratio for what you're calling my source image.

Utley: No, you've got...I don't know anything about that. All I know is that is this.

Armstrong: This is the source image. That's why I asked you which one was the source. This ends up being the source. <Everyone talking at once.> ...the original picture...

Utley: I don't know anything about that.

Bernstein: Why?

Utley: Because what you put in the scanner, the system considers to be the source image.

Armstrong: Although there is a step here...

Bernstein: Well, this is what I was putting in the scanner.

Armstrong: There is a potential step here is not a part then...

Armstrong: Because then the enlarged image is the source image.

Utley: Right.

Armstrong: Because there's a step before digitizing that says we can take an image of any size, create the ultimate source image from that in any dimension you'd like via cropping and enlarging, and then we will end up with what we are calling in these formulas a source image. But we don't talk about this. I don't know if it's important, but it's a step that confused me.

Armstrong: Brian's saying it's not important.

Armstrong: It's not important to this formula; but what I'm wondering if it's important to our process.

Bernstein: Well, certainly it's part of the process.

Utley: Well, no, if you go back through and you understand this, what your controllables are, what your scan density is, what your aspect ratio is, how you fit it into the viewing window, what your target size is, and if you know all of that, you can determine the trade-off between your ultimate source, whatever that be, I know nothing about that, and what you put in your system.

Bernstein: I recognize that. I'm one step before that whole process, and now we're taking ourselves outside of the math, and then we can table this and you guys can talk about it later. You just told me that this lower image is the source image.

Utley: Right.

Bernstein: Yet it's not what the client gave me. The client gave me this picture. Greg Manning gave me a baseball card with a whole bunch of header information and said take the header out, give me just the picture of [Newell] Lowell or whatever his name was...just the picture. So, I don't know if we want to include anywhere, if it's important, the step that is our editing of an original image before it becomes what we are calling a source image. That's all. And let's leave it there for right now.

Boehm: That's the same problem I was confused with, and when I look at Brian's figure to say that the target image is surrounding the viewing image, I get confused as to what he means by the target image.

Utley: Well, the target image is the file...

Boehm: What's the word "target" mean?

Utley: Because what you are doing is you create a virtual image into which you zoom and pan. It is a virtual image.

Boehm: Oh, so you're targeting to the virtual image?

Utley: Yeah.

Bernstein: Or you're targeting that big [].

Armstrong: What you're talk about is semantics, and I had the same conceptual problem on my first read, understanding the difference between target, source, and viewing.

Boehm: And viewing, yeah.

Armstrong: And that's something you guys can talk about, and that's just really a global change in semantics if you decide to do that. But I'd like to move onto the next question I have that's formula driven, and it's the scan density.

Utley: Right. It's not in here, it's on the image sizing program.

Armstrong: This?

Utley: No, the other one that I have where you put in your parameters, and it automatically computes.

Boehm: You can use an Exel spreadsheet with macros to do that with code. We have not written an application on that yet.

Bernstein: Well, that should be here.

Armstrong: Yeah, because we reference it. We reference...

Boehm: You reference the program?

Bernstein: We reference the math.

Armstrong: In line 11, we're talking about how we determine a minimum scan density, and we actually have a formula here, which I don't understand.

Utley: The minimum scan density says that you will scan at that DPI or...

Armstrong: That's height, or is it area?

Utley: No, it's scan density.

Armstrong: Okay, let's look at this formula then.

Boehm: Where are you? What page?

Armstrong: I'm on page 13, line 13.

Utley: It's the ratio of the source image height to the target image height.

Armstrong: Just height? There's no width...

Utley: No.

Armstrong: ...in there at all?

Utley: No, because you've got a fixed aspect ratio. The two aspect ratios are the same, therefore it doesn't matter. And if you try to use area, it's a square function, so it doesn't give you the right answer.

Armstrong: And does this end up giving us the dots-per-inch result?

Utley: Yeah.

Armstrong: So if I've got a height, then you're saying we're expressing the height in terms of pixels?

Utley: It can be either in inches or in pixels. Typically it's in inches because when you want a...your scan density is when you're scanning, and you're scanning is in...

Armstrong: Okay, then let's use an example I put here. If we have a source image of an 8x10, and our target image is going to be...let's fix this and call it an 80x100 so we keep the same aspect ratio...

Utley: Right.

Armstrong: We then end up with an MSD of the height...

Utley: Your target's going to be in pixels.

Armstrong: Okay, well this is what I want to clarify, then, because that doesn't say it. So the target...

Utley: The target is always defined in pixels. It says area in there, but it's always pixels.

Armstrong: Okay. But we don't always use the TIH in a formula in a pixel form.

Utley: You always use it in pixel form.

Armstrong: We do?

Utley: Yeah. That's the only way it's ever expressed.

Armstrong: Even up in these formulas and everything?

Utley: Yeah.

Boehm: Does it have to be in pixel? Can it be units?

Utley: No, it has to be pixels.

Armstrong: And the viewing image width is always in pixels?

Utley: Yep.

Boehm: Viewing target but not source?

Utley: Well, the source is whatever medium the source is in. If it's a 4x5 piece of film or an 8x10 enlargement, or whatever.

Armstrong: Well, let's follow this through then. So...

Bernstein: Then that's not a source image. The source image is what you create by forming the 4x5.

Armstrong: That's something we need to clarify.

Boehm: Exactly.

Armstrong: We need to be able to say the target image in these formulas...or to calculate them, target image heights, widths, and sizes are all...

Utley: Viewing window is in pixels, height in pixels. Okay. Source image generally in inches. I mean, I laid that out.

Armstrong: Okay. It wasn't in this one. But let's just look at this for a second. What would the number of pixels be on something like this if I've got 80"x100"? What would 80" be in pixels?

Utley: That's probably around 8,000.

Armstrong: 8,000. So we've got 8,000 pixels divided by the height of the source image is 8, so we have a scan density of 1,000.

Utley: Right.

Armstrong: Okay. That works. Fine. Okay, example 1. Let's go to example 1. Your assumptions, for example, you want to change from this sheet to the next, Brian?

Utley: Right.

Boehm: Are we doing example 1 of the...

Armstrong: On page 13, beginning on line 17.

Boehm: Are there changes, Brian?

Armstrong: Perhaps. We're going to go through it.

Utley: I'll look at it and see.

Boehm: Why don't we just go to the example 1 in your new?

Utley: Okay.

Boehm: Unless it's the furthest.

Armstrong: It's not furthest. Okay. So we've got a source. Everything's the same here. 320x48 is 400 pixels. Viewing image size is equal to 128. Target image size is equal to 2560. Good, we've got the square root in the formula now. The 1789. Target image height is 1431. Minimum scan density, I think is wrong.

Utley: No, it's not.

Armstrong: The minimum scan density is said to be...

Utley: You multiply the minimum scan density...

Armstrong: Right, but let's just do the formula. The minimum scan density is what? Defined as the target image height, which is what? 1431, right?

Utley: Right.

Armstrong: Okay. You have 1789.

Utley: Oh, I'm sorry. The target image height...you start with the target image width...you can do it either way. It's 1431 is the target image height.

Armstrong: Right. That's the formula. So in order to use your formula, it's 1431 divided by what?

Utley: By 4.

Armstrong: Not by 5?

Utley: No.

Armstrong: Okay, so that's just a general correction. You actually end up with a very similar answer, mildly different by only, I think. .75, but it is different. Oh, no, you don't. You get...wait a minute. <reading to himself> ... is the target image height in example 1...it may just be a rounding function...

Utley: It is.

Armstrong: But as we show the math, we should show it consistent with the formula, right?

Utley: Yeah. What does it say?

Armstrong: 357.75.

Utley: Right. Just round it up to 358. There are no such things as fractions of pixel settings.

Armstrong: $1789/5 = 357.8$, so it's slightly different, so that's why...

Utley: It's not different. You can't have a fraction of a pixel.

Armstrong: Don't get upset about this. You have an error in the way you show this, and all I'm doing is pointing out that we can't have it in the patent that way. We have a formula that says it's height divided by...it should be 1431 divided by 4. We just went over that on the previous page. That's all I'm saying. Either way, we need to express it as 1431...that's all I'm saying.

Utley: I see what you're saying. I understand.

Armstrong: Do you have that, Doug?

Boehm: No, I'm still trying to figure out...

Armstrong: Okay, look on his new sheet.

Boehm: Yeah.

Armstrong: The only correction to his new sheet on page 1 is the second to the last line. "The minimum scan density equals 1431 divided by 4 equals 358." That's the only change.

Boehm: Okay.

Armstrong: Now, let's see...did I have anything on this one?

Boehm: Good catch, Jim. Thanks.

Bernstein: On 2, I think we have the same file [].

Boehm: What?

Bernstein: We're best friends for this very reason. I sucked in math.

Armstrong: This one's just the exact same thing on 2 where we're just using the wrong number. We get the same answer, but we're using the wrong number. The minimum scan density, second to the last line, should be 1431 divided by 4 equals 358.

Boehm: Which is the same...

Utley: It's the same number.

Boehm: The same fixes as...

Armstrong: Exactly. Same number, it's just the equation is expressed incorrectly.

Boehm: It's the same text...the same change we made to example 1.

Armstrong: Exactly, exactly. In the middle of that example 2 on page 4, there's a statement that says, "The target image size equals the viewing image size times twenty." I can't find where that relationship is defined in a previous example where we say that the target image size equals the magnification factor times the viewing image size. And if it's not, we need to just put it in because it's obviously right, it's just not stated.

Boehm: On the top of page 2, when you define magnification factor, and you're saying it's a ratio of the viewing image to the behind-the-scenes target image, so it's going to be a less-than-a-one number. See, we're getting targets and viewing screwed up. The terminology, I think, is screwing us up, right? Because weren't you using magnification factors of twenty? That would have a viewing image of twenty sizes larger than the target image.

Bernstein: That's what we found last night...

Utley: No, the magnification factor is the...the target image size is the viewing image size times the magnification factor.

Boehm: Right, how do you define the magnification factor...oh, that's what...the viewing size...

Armstrong: But in the patent pages, do we have that, Brian, somewhere? Because I looked for it, and I couldn't find it.

Boehm: It's page 12, the middle, it's where he defines magnification factor, and it's not where it should be.

Armstrong: Right, but I don't see it there.

Boehm: "...ratio of the target..." we're going to call it "...the target image area."

Utley: It's down on the bottom. "The target image size is the target image weight times the..."
"...which is equal to the..."

Armstrong: There it is. "...viewing image size times magnification factor."

Boehm: Right.

Armstrong: Okay, so that's the one I had a problem with because we inverted those two things, so that explains that. That's fine. Let's move on. Now, did I have anything else on examples? Example 2...example 2...

Boehm: One more point. When you say the magnification factor, it's really the maximum desired, isn't it? Magnification factor, Brian?

Utley: Yeah.

Boehm: Because magnification factor is any zoom. What you're worried about is the maximum, your deepest, right?

Utley: Right.

Boehm: Okay. So I want to make this MMF for Maximum Magnification Factor, okay?

Armstrong: Okay.

Bernstein: Where was that?

Boehm: I'll fix it. Don't worry about it. It's really at...

Utley: The magnification factor is the maximum magnification factor.

Armstrong: Always?

Utley: Yeah.

Armstrong: What about the minimum?

Utley: The minimum is 1.

Armstrong: 1 plus something?

Utley: Right. Now, then, this is what you're designing it to.

Armstrong: Page 5 of Brian's new thing...page 5, example 3. This minimum scanned density, again, I think is wrong. We've got a target image...what is the formula again? I keep forgetting. Target image height of 1610, right?

Utley: Where?

Armstrong: Example 3. 1610 divided by the source image height, which is 5. So 1610 divided by 5 is 322. So it's just the expression is consistently just reversed.

Boehm: And you're on page 5, it's the minimum scan density?

Armstrong: Minimum scan density equals 1610 divided by 5, which equals 322.

Boehm: Okay.

Bernstein: What is that last? "The photos can be any scan density greater than 321"?

Utley: As long as you scan at a higher density than that, you will never pixilate.

Armstrong: Since we get to this answer here, that's his conclusion. You have to be at least 322...321.

Bernstein: For that particular example?

Armstrong: Yes. That's the answer to his equation.

Utley: What this is telling you is that when you scan this image in, you've got to do...you've got to start at least at this density.

Bernstein: To get that result of 20?

Utley: To get that result.

Bernstein: I finally understand.

Armstrong: Okay, let's go to page 20 in the patent file.

Boehm: Okay.

Armstrong: It was...actually, never mind. At the bottom of page 20 where I say, "really?" I already talked to Brian; I understand completely why that is now.

<Difficult to understand; Boehm and Armstrong having a side conversation.>

Boehm: Okay.

Armstrong: And as long as this one has the square root thing in it, which I'm sure it does, then we're fine on that example.

Utley: It does.

Armstrong: Okay.

Bernstein: Doug, you're supposed to be picking up these square root issues...

Boehm: Hey, you guys are supposed to be picking this up. Actually, I was hoping you could work closer with Steve than the timeframe we had; but I'm taking the last pass at it here, so I'm going to try and get another pass at it.

Bernstein: Cool.

Boehm: And I am trying to get another pass at it, and I would have done the same number exercise that you've done for us, Jim.

Utley: <As an aside to Jim and Eliot.> Can you meet me in Philadelphia on Friday morning?

Armstrong: I think so.

Bernstein: This Friday? I don't know.

Armstrong: Well, I need to check my calendar.

Bernstein: Other than just checking?

Armstrong: Yeah. What time?

Utley: Can you pick me up at the airport?

Armstrong: Yeah.

<Continued background conversation between Utley and Armstrong.>

Bernstein: Doug, why don't you make these changes?

Boehm: Yeah, I will.

Bernstein: Start with this because I think we can pick up our changes later, can't we?

Armstrong: Well, let me give you a few more that I wasn't real sure about.

Boehm: Well, what's the...what do you think is the extent? If we go through page by page, you're right, it's going to be forever.

Bernstein: No, I just want to go through my comments real quick. If Brian has any additional, that's fine.

Boehm: Okay, and remember we can change the wording of the claim as long as it's recorded.

Bernstein: No, no, this is the body. These are minor fixes.

<Everyone talking at once. Shuffling as Armstrong leaves the room.>

Boehm: Thanks, Jim, for leaving.

Utley: <Chuckles.> He's going to catch a plane.

Boehm: Hope you had better luck than I did.

Utley: Yeah, really, and the weather here right now is pretty bad.

Boehm: Yeah, that's what it was yesterday.

Utley: Where did you get stranded?

Boehm: It's a long story. Is now a good time?

Utley: How long is it going to take?

Boehm: What happened was I left about 6:00. Everybody said it's no problem to catch the 7:25. There was a terrific traffic jam just north of the airport, bumper to bumper for miles, and it got to be 7:10 before I was at the airport. I was flying around lost, trying to find the Avis. Got to the bus at 7:15. Yelled at the driver and said, "I've got a 7:25 flight. Can we do it?" He goes, "I don't know!" So we got in and tried it. They dropped me off at the United gate. And I dropped up the Avis car without filling it with gas, you know, just get my butt over there. I get up to the drop-off, and thinking, oh, I gotta run, and so I run like crazy to get to the get and find out different.

There's a whole bunch of people standing there, you don't have to run. It's been delayed. So my flight out of Ft. Lauderdale to Chicago was delayed first of all for storms, and then mechanical problems. I got switched all over the place. 7:30, 8:30, 9:30, and you wonder what's going on. Half the people bail out and go to Miami and fly out of there, and they keep saying, oh, we don't know when it's coming. I'm thinking, oh, crap, I'm going to miss my 10:30 connection in Chicago to go to Milwaukee, so I called and found that there was a bus. There was an 11:30 bus, and I thought, hey, I'm gonna make this, no problem. The stupid plane didn't leave until 10:00, got in Chicago at 12:30, missed the bus, missed the only connection out to Milwaukee. I'm thinking the next one's 8:00 in the morning, I'll just go get a hotel, and it should be on the airline, right? Because they made me miss my connection. So I stood in line 45 minutes with other people who had missed their connections to try and get the hotel or the baggage lost or some damn thing. Here it is 1:15, 1:30, and they say...and this guy in line behind me, he's in line for the second time because they sent him in a cab off to a suburban hotel—not the Hotel Hilton, no way—some suburban hotel—sent him out there, he got there and there was no room, so they brought him back, and now he's in line again! Talk about getting doubly screwed. Anyway, I get up to the counter, and she says, well, we can send you out to Arlington Heights—and I know the area, I grew up around there—a hotel, and we've got to get you a cab, and we'll bring you back, and we'll pay for the hotel. And I'm saying, when's my flight? 8:15. I've got to be in there by 7:30. You're going to get me out there, and I would have gotten maybe three hours of sleep. It was just ridiculous. So I said, what are my other options? I'm pissed. So she turns around and grabs a pillow and a blanket and says here's your other option. Everybody is kind of fuming, but we're all taking it with a grain of salt. The guy next to me says, oh, you get the Hotel O'Hare, and you're headed over to Gate B-20? That's Suite B-20!

Bernstein: And it is. I've done that so many times. Slept there many a night. Slept on my bag.

Boehm: I got in here this morning, landed at 9:00, and drove to work at 9:30. I haven't been home.

Utlely: And you are feeling the same.

Boehm: Oh, yeah, really crunchy!

Bernstein: Okay, let me whip through this real quick. Skip the comment on top of page 9. On the bottom of 9, why can't these images from videos be put back into video format and then zoomed on? Why can't you take the images you captured in video, enhance them, and then put the 29-per-second back in, thereby have zoomable video? And panable? You can because a video is simply 29 images. So if we've captured the ability to do this on an image, we can create video by creating a series of 29 images per second.

Boehm: Okay.

Bernstein: It can be easily done. Here's the change. On line 21, just add: "A single or all captured frames from the video camera may be further processed as a digital image, and then reassembled back to video." Take all the frames, do...

Utlely: What are you going to do with it?

Bernstein: You're going to enlarge them, however you do that once you capture them. If you were just printing them, you could print the images, enlarge them, put them in a viewing window, and run that video through there and let somebody zoom in.

Utlely: How do you run the video through a viewing window?

Bernstein: Doesn't the video have its own viewing window?

Utlely: You run it through a player.

Bernstein: And the player has a viewing window.

Utley: And the player has a viewing window.

Bernstein: Now, if the image is bigger than the viewing window, you'll be able to...if the picture is bigger than the set viewing image, you'll still be able to...

Utley: The picture will still be in the standard frame size of 320x240.

Bernstein: They'll be in a frame size, but the picture will be much bigger than 320x240.

Utley: No, the picture can't be bigger than the frame size.

Bernstein: On a video? Why?

Utley: Because that's what you cover.

Bernstein: I see what you're saying. But would you be able to take a 20...no...and play them through...okay, scratch it.

Boehm: All this stuff at the bottom of the page?

Bernstein: No, left side.

Boehm: Just the left side?

Bernstein: And then still make the change on 21: "A single or all captured frames from the video camera may be further processed."

Boehm: But we're only talking a single frame is processed as a digital image.

Bernstein: So it won't matter if you do it multiple?

Boehm: Yeah, but you're doing single, multiple times.

Bernstein: Yes, okay, fine.

Boehm: Maybe we should say...no, single is fine. I think...

Bernstein: Is a scanning a digital enlarger to me? To my thinking?

Utley: Yes.

Bernstein: I just don't understand why?

Utley: Yeah, it's a digital...well, yeah, the way it is is you change the scan density. That will give the effect of the enlargement.

Boehm: Is that said here, Brian?

Utley: Yeah.

Boehm: Does that say that in here? That changing the scan density is effectively enlarging it?

Utley: It's enlarging it because you're increasing the number of files.

Bernstein: What you said, sir, because it confuses me!

Boehm: And not only that, we may need it. If we're practicing that...are we practicing that?

Utley: That was the whole point of going through the magnification factor and creating a scan density because you've got to create a picture large enough to be what you want it to be as a target image.

Boehm: Never mind!

Bernstein: Okay, but you see it now, right?

Boehm: Yeah, absolutely. I just didn't...

Bernstein: And to me, who doesn't understand the math of all that, it seems very strange that you can take a digital image and it's achieved everything by blowing up...

Utlely: Optically.

Bernstein: ...optically. And then you're still putting it in the frame and framing it right until it works in a zoom environment. If I could understand the math, I'd understand that. I understand the theory.

Boehm: Brian, I know what I'm talking about.

Utlely: I never questioned that! <Laughter>

Boehm: I do, all the time! No, when I'm thinking enlarging, I'm thinking of analog development enlarging.

Utlely: Optically.

Boehm: Optically enlarging, not digitally enlarging. Are you digitally enlarging the photo when you up the scan density? No.

Utlely: Let me give you the ...

Boehm: You're upping the scan density.

Utlely: Yeah. If you enlarge a photograph, you can set it at a lower scan density than if you don't, then you have to scan at the high density to get the same result.

Boehm: Exactly. That's why I don't think that a scanner is technically an enlarger.

Utlely: It performs a function. Because it has a variable scan density...

Boehm: Yeah.

Utlely: Enlarging is better [in] the size of the file that is produced. And the size of the file is proportional to the size of the image.

Bernstein: Oh, I see. I see it! It has to be. It effectively does the same thing.

Boehm: Yeah, I guess the scanner can do enlarging, yeah.

Utley: It can produce two different-sized files based on the same photograph being scanned at two different densities.

Bernstein: Which is two different sizes. You see, the brain doesn't think that. You just think 600 versus 900 just means more dots or something. Period. It doesn't mean that you have more area.

Utley: That's right.

Bernstein: But is it?

Utley: When you have more area, you scan at a lower density. You scan at 200 DPI versus 600 DPI.

Bernstein: But what if there's no scan, no density...the camera does that?

Utley: Then it's fixed by what the camera does.

Bernstein: Can you set the camera to be the enlarger?

Utley: No, you have very little control over that. When you go through the digital example, that's what happens.

Bernstein: What?

Utley: You say, well, I got this digital picture, and I want to get a 20-times magnification, and you go through the math and it says "stop!" You can't get 20 times; you can only get 11.1 times.

Bernstein: Why?

Utley: Because you can't get more pixels in the target image than you've got in the source.

Bernstein: So how do you achieve 20 times?

Utley: You have to have better digital equipment.

Bernstein: Okay, so you can buy a better digital camera that gives you more [pells?] for the shot?

Utley: Right.

Bernstein: And as that comes due, that's going to give us greater magnification.

Boehm: Brian, if you took a normal enlargement on a photo, you will keep enlarging until you get the grain level of the photo.

Utley: Right.

Boehm: On a scanner, you won't keep enlarging...I mean, you're going to hit the grain level of the photo, but it's going to be limited by the scanner.

Utley: Well, yes, there are some limitations. For instance, ...

Boehm: An optical one is never limited by the optics, right?

Utley: Yes, optics have limitations.

Boehm: Okay, but way far...

Utley: But what happens is the scanner can't put detail into a picture where it isn't in the picture. So you can take a snapshot, for instance, and try to scan it at 1000 DPI, but it won't look any better than if it was scanned at 150 DPI because that's all the information there is on the image that you can resolve. In other words, you have been destroyed by the processes that printed it. But if you take a transparency—the original source transparency, whether it be a positive or a negative—you can scan that at a very high density, and you can get every bit of information that there is to be obtained by increasing the scan density assuming that you have a scanner that is capable of that.

Boehm: Yeah, with no limitations. Yeah, you're right.

Bernstein: So, should we say all of that?

Boehm: The math is saying it, you just have to sit back and think about it.

Bernstein: Okay, that's good.

Boehm: But you're right, it would be a good thing to say. If you could...

Utley: That's why the math is there.

Boehm: But Brian, if you could say that in English, it would be even better. If, after we cut the phone call, if you wanted to jot a note...

Utley: My brain doesn't work very well in English.
<Laughter>

Bernstein: Do you want English American or English British? Let's define that. Let's go right here and define that because that is important.

Boehm: Okay, so what we're saying is that by increasing the scan density, it effectively...well, first of all, what is it actually doing? It's more data or pixels per image which lets you magnify deeper or more...

Utley: Let's back it up. What we want is a large enough...our objective is to get a large enough digital image file to permit the zooming and panning at the desired magnification to take place. There are two ways to obtain that size file. One is by enlarging photographically and scanning at a relatively low density, or by that the source image is of sufficient precision to scan at a high density to create the same size file.

Boehm: But, wait, you don't scan, if it's digital. If you have a digital, you're not...

Bernstein: Wow, you see, you've got to clarify two things: scanning and digitally shooting the photograph with the right specs.

Utlely: When you scan, you create a digital file. Alternatively, you have a digital camera which gives you a fixed file size.

Bernstein: Although later in the future, you should be able to do inside the digital camera what you're doing with the scanner, and create, when you get a good enough [pell] count, so to speak, right?

Boehm: But it's technically not scanning, it's the digital files coming directly from the camera is what he was trying to get across.

Bernstein: But it's creating a size.

Boehm: What?

Utlely: The end result is to have a file which is sufficiently large...the file of an image when expressed in [pells?] has a large enough area to allow you to zoom into the image and obtain the desired level of magnification.

Boehm: Without pixelating.

Utlely: Without pixelating.

Boehm: Okay, that makes perfect sense. Now, when we were talking about a scanner being essentially an enlarger, if you...you see, when I think of a scanner, I think of analog to digital. It's taking optical and digitizing it. It's doing the capturing.

Bernstein: Right, but...

Boehm: On a digital camera, the [CCD] is doing the capturing.

Utlely: Which is an array.

Boehm: Which is a scanner. I see what you're saying.

Utlely: Right. It is a scanner. Now, the...

Boehm: The scan density number you're spitting out for your HP scanner or for to go buy a new proper...

Utley: No, you can control the scan density of a scanner. You can determine what your scan ratio is.

Boehm: Of a scanner?

Utley: Yes.

Boehm: But not of a digital camera yet.

Utley: No.

Bernstein: Sure. You can go from 300 DPI to 600 DPI.

Utley: Not on digital cameras.

Bernstein: Sure. On my digital camera, I can set it to 300 for low resolution, to high of 600.

Utley: Yeah, but when you do that, you're getting a .JPG.

Bernstein: Right. Or bitmap.

Utley: It doesn't give you both bitmaps. I think it only gives you one bitmap, which is your maximum density.

Bernstein: Well, the highest, 600, is a bit map; the other one is...

Utley: Right. The other one is a .JPG. That's right. That's absolutely right. But there's only one bitmap. You can only go to one bitmap size now. Even the new Nikon 990, it only gives you one size bitmap.

Bernstein: It does?...

<End Side 1, Tape 2; begin Side 2, Tape 2.>

Utley: You said in the compression step, there are a number of options that you have to tailor the

compression process. You can give the compressor a target for how much compression you want. You can also specify to the compression program the size of the compressed image, and that's important because what you do with the image sizing program, the image sizing program will tell you what the size of the compressed image should be to create the target image. Therefore, you instruct the compressor to create a compressed image of that size. Remember you had a minimum scan density?

Boehm: Um, hum.

Utley: Typically, you will scan at a higher density than the minimum scan density, maybe 10%, maybe 20%. So now you have to take that digital file and create a file which is equal to the target image, and you do that by telling the compression program that's what you want. If you didn't have a compression program, then you would try to scan as close to the minimum scan density you could so as to not create a bigger target image file than you needed.

Bernstein: Okay, now, I didn't totally understand that. He then says compression serves to preserve image resolution. Is that a true statement?

Utley: Um, hum.

Bernstein: Thereby providing an optimum enhanced digital image. Optimal is no compression.

Utley: Well, it depends on what you mean.

Bernstein: Well, did you see the...17 going to 18?

Utley: You made the optimizing file size.

Bernstein: But then that needs to be defined here. Do you follow that, Doug?

Boehm: Yeah.

Utley: By optimum, we really mean optimum file size here.

Boehm: Yeah, since the number of pixels is not actually reduced.

Bernstein: No, actually if you size it, they are reduced.
Utley: If you specify a small number, yes. What you really try to do is optimize the file size at the appropriate number of pixels.

Boehm: But the number of pixels changes when you .JPG it...I mean, when you compress it or .JPG?

Bernstein: No, when you compress it and resize it.

Utley: It's optical.

Bernstein: If you're compressing by resizing, you've lowered the pixel count. If you're compressing 1:1, you haven't. Do you follow? So Brian's saying you might have a large image and the compressor says, what do you really need here? Let's get rid of some color. Do you need all this extra size and that height and width? And if not, it does all that for you. Lowest makes the smallest picture, thereby reducing pixel count and providing a less-than-optimum enhanced digital image.

Boehm: Help me figure out what that sentence should say.

Bernstein: I'd strike the whole sentence, to be honest with you.

Boehm: That sounds fine with me. Will we ever need the concept that we preserve the number of pixels, at least at the 1:1?

Bernstein: No.

Boehm: Through compression?

Bernstein: No. Compression is optional. Do you know what I mean?

Boehm: Okay, scratch the damn sentence.

Bernstein: Yeah, okay. Good. I see that we can explain all of this. I would just leave it right after "...be set to other compression factors..."

Boehm: Yes, absolutely. That's the end of the sentence, end of the paragraph.

Bernstein: Exactly. That "64 user interface or control data is associated with enhanced digital image file if necessary and may already be on the user computer."

Boehm: You got it.

Bernstein: It's still associated, even if it is on his computer, so that, in this sense, you might be right here, because you still need to associate the control data user interface with the picture. So that's true.

Boehm: So I'll move your comment down to clarify it later.

Bernstein: Okay. And the only other thing is right after you say on line 6: "...graphic user interface on display upon loading..." Forget "downloading" and just put "loading of the image."

Boehm: Okay.

Utley: Doug, I can give you the wording that I used. At the bottom of page 17, in place of that last sentence which spills over it, I said, "The target image dimensions can be set as parameters for compression thus ensuring an optimum enhanced digital image."

Bernstein: One more time?

Utley: "The target image dimensions can be set as parameters for compression, thus ensuring an optimum enhanced digital image."

Boehm: But what are we optimizing?

Utley: File size here.

Boehm: The file size?

Utley: We're getting the maximum image quality and minimum file size.

Bernstein: For what we need to achieve. That's right. That's fine. Because that's here...

Boehm: "...thus ensuring optimum quality and file size"?

Bernstein: You're not ensuring any optimum qualities by compressing. You're actually decreasing quality at that point.

Boehm: That's right. So, "...thus ensuring an optimum compressed file size"?

Bernstein: Yes. "...compressed file to image size," right?

Utley: No, file size.

Bernstein: And that does say it, by the way. Okay. Now, go down to line 8: "Image file []. The user interface program is associated with the enhanced digital image file such that the combined"...take "download" out...

Boehm: Okay.

Bernstein: "...the combined file or files..."

Boehm: Well, it's not combined if it's files.

Bernstein: Well, no, it could be three files, or it could be all packaged into the image file someday. We don't know.

Boehm: Well, I've got to define that better when we hit the claims because I'm thinking about not...we're claiming that we're...that the end product is a file, an enhanced file, and then we get lost in the mucky-muck when we say what we are really providing. We're providing a .JPG and an applet.

Bernstein: Well, we don't have to provide...they just need to combine somehow. We don't need to provide all the elements.

Boehm: Yeah. The ultimate thing that we provide may not be a file—an enhanced digital image file—does it have to be a file?

Bernstein: An enhanced digital signal?

Boehm: Data?

Bernstein: Data?

Boehm: Or signal.

Bernstein: Yeah, okay, so make that global change. That's fine. It doesn't have to be a file necessarily.

Utley: No.

Boehm: Well, it would have to be digital data, though.

Bernstein: Right.

Boehm: It doesn't have to be an analog signal.

Bernstein: Right. That's true.

Boehm: So I don't need the word "signal."

Bernstein: But you might not have to save it as a file at some point in life.

Boehm: Well, data incorporates if it's a signal or not because the data would be on the signal, right?

Bernstein: Perfect.

Boehm: So I don't need signal because I don't want to go analog on people.

Bernstein: No, I understand. "The combined files, like computer [], will automatically launch the graphic user interface.." It doesn't have to automatically, but it can.

Boehm: Okay, "can."

Bernstein: Right. "...decompress the digital image data and display a portion of the digital image data within a viewing window having a predetermined viewing size."

Boehm: Okay.

Bernstein: Correct? Putting in a portion of the data.

Utley: Actually, when it comes up, it tries to present the whole image.

Bernstein: But in those virtual pores.

Utley: That's right.

Bernstein: So we want to say "a portion of," or "the entire or a portion thereof."

Boehm: "...at least a portion..."

Utley: "...at least a portion..."

Bernstein: There you go. Okay. Skip now to the next page. You've got my seamless word there, but I don't want it.

Boehm: Don't want seamlessly, huh?

Bernstein: Doug, but you say "...to or from a host computer..." on line 11 "...a Web server, Web site, or a Web page...."

Boehm: Um, hum.

Utley: TV?

Bernstein: I don't know if you want to throw it in there.

Boehm: I'm lost where we are in terms of...

Bernstein: Page 19, 11.

Boehm: We're at figures 3, describing the flowchart of figure 3?

Bernstein: Right.

Boehm: Which is...oh, great. Is that what that said? Oh, it's not a flowchart, it's an image...figure 3 is an image. <Reading out loud to himself; quickly and maybe not completely.> "Referring to figure 3, an exemplary screen print is this. Once the user interface...the resulting image is ready for uploading to a network server projection..."

Bernstein: Well, that was not my thing. "...the resulting image can be uploaded to a network server..."

Boehm: That whole thing, Eliot, on that, you kind of have to take it with a grain of salt because all of the...this is the description of the preferred embodiment.

Bernstein: Okay, okay.

Boehm: It's like the background.

Bernstein: That's what we did. That's fine, that's fine.

Boehm: This is really preferred.

Bernstein: I know, you see what I'm doing now?

Boehm: Yeah, and that's good because that makes me want to support it more so I can broaden the claims...go somewhere with the claims. So technically, Steve's correct by saying "uploading" because it's the hit-preferred embodiment.

Bernstein: Right.

Boehm: But I usually say "can be" or "is" or "may be," and he doesn't like to say "preferably," but I do. It's just a semantics.

Bernstein: No problem. Go down to line 19, "...and it should be the result of a download/upload..."

Boehm: What's being...

Bernstein: "...the results of loading the enhanced digital image to a user computer..." would be the right way to say it.

Boehm: Yeah.

Bernstein: So take out the "down" and trim it to "loading."

Boehm: Yeah. The same thing to the network server. If you load it to the computer 22, it's providing it to a network server. I don't like this loading...

Bernstein: Yeah, I don't. It's very tight on us.

Boehm: Yeah, and it infers uploading and downloading.

Bernstein: I agree.

Boehm: But, again, he's right because in the preferred embodiment...

Bernstein: That's fine as long as later we clarify and make sure we're protected on all of these issues.

Boehm: <Reading out loud to himself.> "...but download of the enhanced digital image file to a user computer..."

Bernstein: And that's true in the preferred embodiment...

Boehm: But that's for load over the Internet is what he means.

Bernstein: What?

Boehm: He means download off the Internet.

Bernstein: It could be an intranet. It could be...

Boehm: The network. Off the network is what he means.

Bernstein: Right.

Boehm: But isn't it a download off the network? Because when you put something on a network, you upload through the network and download from the network. So he's right, but...

Bernstein: Yeah, you see the issue.

Boehm: Okay, it doesn't have to be. I agree.

Bernstein: Okay, and I've got that next one covered. Go now to page 20. Okay, we've got a big problem here. "The program loads additional digital image data from the enhanced digital file..." Scratch "image stored in memory, for example hard drives," and just say, "program loads additional digital image data from the enhanced digital file to the display viewing window by providing additional data from the source to the viewing area seamlessly..." or something. Or just make it a period after "...display viewing window." You follow me?

Boehm: Uh, huh.

Bernstein: "...to the user display viewing window."

Boehm: "...viewing window." Period.

Bernstein: Okay, any of that other stuff. Okay.

Boehm: <Reading out loud to himself.> "...the user computer provides the zoom..." Oh, "to provide the zoom to view..."?

Bernstein: Excuse me?

Boehm: Holy smokes. Wow, the paragraph starts out in figure 4, which is figure 4, take a look at, we're about ready to zoom or we have zoomed. He has, "The user has actuated the zoom buttons to zoom in to the digital image data..."

Bernstein: What line are you on?

Boehm: Page 19 at the bottom.

Bernstein: Line what?

Utley: The bottom part.

Boehm: Figure 4. "The user has actuated zoom buttons 88 to zoom into the digital image." Period. I don't want to say "data," right?

Bernstein: Right.

Boehm: "In response, the user interface program, which is the applet, loads additional digital image data..." Eesh, I don't like the "loads" because that says it might be loading it off the network.

Utley: Yeah, I don't either.

Bernstein: "The digital program..."

Boehm: "Provides"?

Bernstein: Yeah, because it's providing it from the enhanced digital file.

Boehm: "From the enhanced digital image file..."

Bernstein: Right. "...to a user's display viewing window."

Boehm: And then, "2. Provide a magnified view of the digital image" or "zoomed visual..." I don't like the word "zoomed."

Bernstein: Yeah.

Boehm: What I would like to say is, "Provided additional image data from the enhanced digital image file, without..." I want to make the clarification there that...

Bernstein: "Without additional ..."

Boehm: "Without another download from the network"?

Bernstein: No.

Boehm: We may not need it here if it's there before, but that's my...I may have to...

Bernstein: Put a question mark there because I see it, too.

Utley: Why can't you say...why can't you relate it to your resolution: "Provides additional image resolution data" because you're improving, increasing the resolution of the image.

Bernstein: As you zoom.

Utley: As you are zooming.

Bernstein: That's actually a great way to start the whole damn thing!

Boehm: Now he tells me!

Bernstein: No, but what we've been looking to describe, he just...

Boehm: I agree. Steve and I have this battle too because you guys weren't...

Bernstein: Struggling.

Boehm: Consistent in the terminology either. No, I agree. If you're talking length times...numbers of pixels, that is resolution.

Utley: So you're providing additional resolution data.

Boehm: That doesn't sound right to me, Brian.

Utley: Well, what you're doing is is you're taking a portion of the image and you're expanding it, really, with additional pixels. So that's additional resolution data.

Boehm: Oh, I see.

Bernstein: Right.

Boehm: What you're saying is it's an adjective...it's digital data that has an image encoded with

enhanced resolution. What are you providing?
You're not providing resolution, you're providing
data.

Bernstein: Data evaluation, necessary for the resolution.

Utlely: But it's pixel-based data.

Boehm: And since it's pixel-based data, it will...

Bernstein: Or additional data for higher resolutions.

Boehm: Yeah, you're getting warm.

Utlely: See, what's happening is that, to put it in
discrete terms, you're going from a case where
you have many source pixels per viewing window
pixel, and you're reducing that ratio as you zoom
in.

Boehm: Right, until you hit the pixelation limit.

Utlely: Until you hit 1:1.

Boehm: Yeah. Okay, let me see if I can patch that up.

Utlely: That's why you are providing additional...

Boehm: We've got a lot of clean talking about to do, so
let's move on. Line 15 now, page 20.

Utlely: "...greater than two times."

Boehm: "...It is important that the digital camera is
configured to acquire a digital image. In this
step, the camera is..." I would say,
"...preferably set to the highest resolution."

Utlely: I think in principal, that's what we would
intuitively do; but essentially, should be
generalize on that?

Bernstein: Yeah, there'll be variations on that.

Utlely: Because as technology evolves...

Boehm: Right. You set the camera to acquire at least enough pixels to magnify...

Bernstein: For the magnification process.

Boehm: But if it's high resolution.

Bernstein: Right, then you get more, even if there's higher resolution available.

Utlely: You see, we don't have cameras that give us very much flexibility here today, but tomorrow we'll have more flexibility.

Boehm: "...In this step..." it's possible the camera is set to acquire? "...at least enough pixels..."

Utlely: Well, you notice that the camera []. The camera has a storage device. It always takes the same number of pixels; it's what it stores that counts.

Boehm: Does a user have any clue of what that is? in other words, how would I know that my camera would do a magnification of 20 on this file?

Bernstein: You don't.

Utlely: What it tells you is you create a high-resolution picture or a low-resolution picture, and if you set it to high, you'll only get a few pictures for whatever your storage medium is.

Bernstein: But I'll be you later, the camera will come out with a dial-in-your-zoom feature. Boom! It'll size it and appropriately....

Utlely: In fact, they're already saying if you set it at this setting, it's equal to an 8x10; and if you set it to this setting, it's a 5x7.

Bernstein: Which is doing what we're doing.

Utlely: That's already happening.

Bernstein: Right, well catch them, because I doubt it was happening in the past.

Utley: It wasn't.

Bernstein: Right. So it's new camera technology that might be infringing already. Which, you know, I see it going in the scanner...all these things.

Utley: You know, sooner or later, Brian, if what you said yesterday was correct, that this is all new, the ability to do it, we'll probably get every single facet of imaging that you know have a zoom factor. Why wouldn't you apply it to every facet?

Utley: Um,hm.

Bernstein: Okay.

Boehm: We could get tripped up, though, since I'm not an expert in the camera art. It might have been done on purpose; and if our claim reads on it, ...

Bernstein: Okay, but what if it was done for a different purpose, and we have a different purpose?

Boehm: If our claim reads on what was done, and it was...

Bernstein: So it wasn't done because I mean...

Boehm: Our camera will already have the capability of providing this file, and our claim says "providing this file," we're in trouble.

Bernstein: So optionally do it. Make it dependent.

Boehm: My secretary is saying we've got to get the checks today.

Bernstein: Okay, but definitely cover that because that's what's going to happen.

Boehm: In the future to set the camera.

Bernstein: No, it's happening. According to Brian, it's happening right now as we speak, so definitely get it in here.

Boehm: "...set the camera, if possible, to the desired magnification or scanned density."

Bernstein: Correct. "...to create that maximum zoom factor." Okay, claim 1, we dealt with. Now "providing" on line 2, we're going to make this a dependent claim now?

Boehm: I'm sorry, I lost you again.

Bernstein: I'm on page 24, claim 1, third paragraph of it, "...providing..."

Boehm: Did he skip some more mass, Brian?

Utley: Beg your pardon?

Boehm: Did he skip some more mass?

Utley: We just skipped over it. We've already done it.

Bernstein: I've never had to grade Jim and his math. Nor Brian's. I've got to tell you, I'm very impressed with Brian's whole grasp of the situation of the math here.

Boehm: Oh, the analysis is great.

Bernstein: It's incredible. It helps me understand it.

Boehm: Are we on 22, Eliot.

Bernstein: We're on 24.

Boehm: On 22, do we not worry about...oh, these aren't your scribbles, okay. I'll play with that. 23?

Bernstein: 24.

Boehm: 24. Got it.

Bernstein: Get rid of the "...size at least twice..."

Boehm: Yep, we'll do the "...greater than..."

Bernstein: "Providing" on line 8 becomes a dependent claim.

Boehm: Right.

Bernstein: Why do we have 10 times 100 times?

Boehm: Because if, again, the Prior Art happens to do it at two times but they do it...

Bernstein: Well then you should do 10, 11, 12...

Boehm: Our claim 1 is gone.

Bernstein: But then you should do 10, 11, 12, 13, 14, up to an infinite number.

Boehm: No, and here's the theory, and this is how dependent claims work, and here's the analysis that we go through. If claim 1 now says "greater than one," if anybody is doing it at greater than one, then claim 1 will fall. It's dead.

Bernstein: Okay.

Boehm: If anybody's done it before, your priority date's before you. Now we move to claim 2. Has anybody done it at least ten times or at least twice will be my next claim.

Bernstein: Right. Ah, that's where you get your "at least twice" in here.

Boehm: Exactly. If the guy didn't do it at least twice, was there a good reason? Did he really not have the same invention? Well, hell, yes, he didn't have the same invention.

Bernstein: That's right.

Boehm: But it just so happened that he did more than one. My claim 1 is dead, and I can now jump to claim 2, which there are at least.

Bernstein: Got ya.

Boehm: That's how dependent claims work. That's why I have dependent claims there because you can't modify claims once they're issued.

Bernstein: Right.

Boehm: The reason why Steve had all those goofy 100s, and 200s and 300s in the spec...

Bernstein: Right?

Boehm: Is because during prosecution, we have them in the claims. And if the Prior Art comes out of the woodwork during prosecution, you might have to go say, oh, well, we didn't mean that, we meant above 100 or above 200.

Bernstein: Gotcha.

Boehm: It's pretty important.

Bernstein: Claim 6, "A single data file to be two files, three files, four files..."

Boehm: Right.

Bernstein: Why?

Boehm: Well, I like that claim.

Bernstein: Well, it could be in the digital image file, I like that, but it could be two, three, or four.

Boehm: But without the claim, ...

Utley: It says you have now to literally [] everything into a single file...

Bernstein: One file.

Utley: ...and you hold that patent.

Bernstein: Oh.

Boehm: And you see, claim 6...

Bernstein: <Talking in background to Utley.> He's got it in one file.

Utley: Right.

Bernstein: [] an image file with an applet built into each.

Utley: I'm on that path.

Bernstein: Beautiful.

Utley: If I had some time to work on it.

Bernstein: I got it. <Laughter.> Is the method of claim 6—we're in the user interface—a Java applet? Why limit it to Java? There are other forms that do this.

Utley: It's already in there.

Bernstein: Where?

Utley: It says in the first claim.

Bernstein: Okay, "...providing a..." which is now going to be a dependent claim.

Utley: It's "...providing the user interface continues to display..."

Bernstein: Okay, which is dependent on it.

Utley: It then further says, okay, and it may be a Java applet.

Bernstein: Right. Okay.

Boehm: Which sort of narrows it up.

Bernstein: Right. Okay. There are other things we could name there—plug-insurance, acrobats.

Boehm: It's only limited if you enforce that claim and if the guy infringes that claim. If it's not a Java applet, this claim won't do you any good. If it is a Java applet that the infringer uses, then

you get to not only throw two claims or three claims at him...

Bernstein: What if it's Active X?

Utley: Yeah, Eliot brings up a good point. There's another technology, which is called Active X...

Boehm: Wonderful.

Utley: ...which already works with Windows, but...

Boehm: But the idea about...can you genericize that to say it's a data code segment? What's an applet? It's a small applications program, right?

Bernstein: Right.

Boehm: Well, let's say that.

Bernstein: Okay.

Boehm: Or we could just say an applet.

Utley: You could say Active X...

Bernstein: Java applet, Active X applet, or other...

Utley: You want a separate claim. Each one should be a separate claim.

Bernstein: Right.

Boehm: What I have to say is "...when the user interface is one of the following, Java or Active X."

Utley: Or "other."

Boehm: No, I can't do "other."

Bernstein: Can you do "other" in a new claim?

Boehm: Nope. The word "other" is invalid in a claim.

Utley: <Inaudible comment.>

Bernstein: In frame 1 because the [] user interface.
Boehm: Yeah, other claims have...

Bernstein: Okay, that's perfectly fine. In that "...further comprising, compressing..." that's optional, right?

Utley: Yeah.

Boehm: Everything here that's dependent is optional.

Bernstein: Okay. "...to a network server..." how about "to a set-top box"?

Boehm: Is that worth a separate dependent...

Bernstein: Absolutely! It's one of the raging things coming down the pipes.

Boehm: Okay, "...set-top box." Can you give me an example of a today technology set-top box that this will work in, and then tell me on figure 1...

Utley: We just happen to know there's development activities going on in a number of different of companies, and they're heading in this direction.

Boehm: Yeah, but your claims have to be buildable by somebody with ordinary skill in the art. Set-top box...

Bernstein: That's just a display system.

Utley: Web TV in an example of a set-top box.

Boehm: Oh, okay, that's right.

Utley: A set-top box that takes streaming information and then presents it on a TV screen.

Boehm: So what's the cable box sitting on my mom's TV? It's just a cable box that goes to the VCR on your TV. That's not a set-top box?

Utley: That is a set-top box. A very simple one.

Boehm: Yeah, it doesn't have a display on it. It uses your TV.

Utlely: It uses your TV, but the newer ones all have computers in them and memory and can convert different formats.

Boehm: Right, but the set-top box itself doesn't have a video display.

Utlely: No, it uses the TV as the video.

Boehm: Yeah, which is Web TV.

Bernstein: So to put in a TV claim.

Boehm: I don't have time to go look at claims right now. We're going to be crunched to get this on file tonight.

Bernstein: Okay.

Boehm: Okay. So my question, again, can you give me an example...you did, Web TV. It's a set manufactured by who? Or is it in there already.

Utlely: Microsoft has a Web TV. And Dell had a Web TV; they just pulled it off the market. But Web TV is a primitive form of what's coming.

Boehm: I know, but you can't patent what's coming unless you can give an example of what you can build today,.

Utlely: Web TV.

Boehm: Good. And I wanted to find out where that was in. Do you remember? I'll find it later.

Bernstein: Okay. Page 26, lines...

Utlely: I'm not through with this one.

Bernstein: Okay.

Utley: Back to the mid area again. "The advantage of claim 1 is it applies to enhanced digital files which are not compressed." We have to make a provision as a dependent claim for transmitting over a network because the one that provides for transmitting over a network is tied to a compressed file.

Boehm: True, but what Steve is doing here in claim 8, there's the compression hanging on claim 1. Now if you do a compression, you can throw claim 8 and claim 1 and them. And if you upload it to a network server, now you can throw claim 9 and 8...

Utley: As long as you don't...

Boehm: if it's on a network server, but it would have to be compressed then. Oh, this is the one you talked about before.

Utley: Right.

Boehm: I'm sorry. So you need number 9 dependent on 1.

Utley: Right.

Boehm: Thank you. That's what we talked about yesterday.

Bernstein: That was it? <to Utley> Okay. 26, line 6,

Boehm: Of what claim?

Bernstein: 13.

Boehm: Line 6 of claim 13...oh, the "...least twice...

Bernstein: ...greater than."

Boehm: Okay. I don't remember...do we have a picture claim, meaning an independent claim that's fairly narrow that reads on your preferred embodiment in your product? We should because that's maybe what we have to go with because now that we've...here's my thinking...and this, Steve and I discussed this ad nauseam here. We're going to go with claim 1 in the EPO. The reason is we're

filing a PCT application now and a U.S. Claims are cheap and free—not free, but they’re cheap—and they take multiple claims in the PCT and in the U.S. But when we split to Europe, they don’t like multiple claims. They will give you one apparatus and one method only if they are related. So we basically pick our best independent claim, but not all the time your broadest, believe it or not because they may find something that is...since you can’t...how do I explain this? If you have your best claim...our claim 1 now is kind of reaching over our product that we really know we can...that we’re comfortable with what we can get, and your product with what you can get right now is too narrow because somebody can modify it. What I usually do in Europe is go somewhere in the middle to get something that’s broad enough to cover your product but still in a real-world application and not trying to claim the world because you don’t get that much leeway to amend in Europe.

Bernstein: Is this to the "...least twice versus greater than one"?

Boehm: If there’s little or no chance that an infringer is not going to do at least two, that will buy you...

Bernstein: There are chances that it might be.

Boehm: But what’s the chance that Prior Art is going to come out of the woodwork...

Bernstein: None because...

Boehm: No, there’s very good chance that Prior Art’s going to come out of the woodwork and blow all of it...

Bernstein: Between 1 and 2?

Boehm: It’s possible.

Bernstein: Well, that's what I'm saying, if that's the case and somebody else beat us to the punch, we should have a claim that takes us all the way from "greater than one." You don't want to box me into that statement; just make it as a claim.

Boehm: Okay, so you're saying that we would file the broadest idea in Europe? Well, we'll discuss that later when Europe rolls around.

Bernstein: Okay.

Boehm: That was why I did...the practice is to do different claims of varying scope and different formats.

Bernstein: Okay, on 15-claim 15-"moving"...is that panning?

Boehm: Yes.

Bernstein: Okay. [Plurality] Jim didn't like that because it means at least two.

Boehm: Jim didn't like it?

Bernstein: Yeah, that's his note. Yeah, absolutely, and that's what it means. That's the whole point of claim 16, which is dependent on 14, which is dependent on 13. Are you with me?

Bernstein: Yes.

Boehm: You're down in the mud now, and plurality may be thing that saves your butt.

Bernstein: Okay.

Boehm: Because your product does these, right?

Utley: Yes.

Boehm: Your preferred embodiment product does these.

Bernstein: Okay. Then my only last question was, can you throw something in to cover the game world? That

specifically relates to gaming and flight simulation?

Boehm: How would we do this? In figure 1.

Bernstein: You'd be able to now use games differently, and you differently can use flight simulators differently.

Boehm: Okay, look at figure 1, Eliot.

Bernstein: Yep.

Boehm: What changes? Just the definition of what 28 is, right?

Bernstein: Figure 21, the display monitor, the display system is what you're saying?

Boehm: No, no, no. Figure 1. What changes when you go to games and flight simulators?

Bernstein: Because in those, the displays become now dependent of parameters of the game or the flight simulator that drive the display window.

Boehm: That's fine, but there's nothing structurally here that changes other than the user computer. It has now the flight program or the game program on it, right?

Utley: What happens is the user interface actually becomes an application-driven interface.

Bernstein: Right.

Utley: That's probably the key difference. And the question was, can we convert that user-driven interface to an application-driven interface?

Boehm: Meaning like a flight simulator program?

Bernstein: Absolutely.

Utley: So that what is displayed is under control of the program and not under control of the user.

Bernstein: Right. Because, you see, you don't want the pilot maybe to be able to do a nosedive. You might want him to be flying along and have a program that says...shock him, make him dive...

Utley: Well, with all the graphics, that the program knows where he is, and therefore moves the display according to where he is and what he's doing.

Bernstein: Right.

Utley: So it's...

Boehm: But under the control of the computer application of its own as opposed to...

Utley: Right.

Boehm: I see. So basically, it's not a network anymore. It basically doesn't fall into figure 1.

Utley: Well, it...

Bernstein: Figure 1 better not tie me to a network.

Boehm: Figure 1 ties you to a network as your preferred embodiment. This'll be probably what's on your...

Utley: It doesn't matter whether it's on a network or not.

Bernstein: Okay, as long as that's true, that's fine.

Utley: What we want is to make sure that what we call the user interface in here can also be a computer-based application interface.

Boehm: Okay, in order to do that, we've got to stick a claim on it or we have to put support in the spec now to do that. So what would we do? All I see that we'd do is...

Bernstein: You could broaden user interface.

Boehm: Yeah, we'll broaden the definition of user interface in the claim.

Bernstein: And then I'd throw in a quick claim that says those two things as examples of it.

Boehm: Good idea.

Bernstein: And we'll let you get to re-writing.

Boehm: Hang on a second...don't go away. "...broaden the user interface to have a control of either the server competitor or the user computer." Right?

Utley: Right.

Bernstein: And when we do that, that really then lays right on top of that disclosure that I made that we had talked about because what one of the items that I wanted to accomplish was to be able to control the display from the computer itself, or from an application, rather than from the user. Remember that?

Boehm: Yeah, sure. And in this example, the flight simulator application program would control the zoom and pan of the display?

Bernstein: Yes.

Boehm: That means you still provided a digital...claim 1 would still say that somebody at sometime provided digital image files for viewing on a computer...

Bernstein: Yes, right.

Boehm: So claim 1 would catch that.

Utley: Claim 1, as long as the user interface can be expanded to include a...

Boehm: Either a downloaded applet.

Utley: A program interface.

Boehm: Any program.

Bernstein: Right.

Utley: Right. And we won't have to say where the program resides.

Boehm: Yeah.

Bernstein: Yeah, because definitely in this world, gaming wouldn't know where to put it because now multiple users can access one central game.

Boehm: Great thought, guys.

Armstrong: Always save some of it for your last-minute work.

Boehm: Yeah, yeah. Well, I've got an hour. That's all. Brian, let's talk about the definition of force target and all that other garbage because I got confused in there, Jim got confused. It's in the specs...Steve did that. Do you know what page it's on because it's all over my desk.

Utley: Yeah, it starts at...

Bernstein: Okay, Doug, I'm done, right?

Utley: Yep.

Bernstein: Can you send me a copy of that? When do you think you'll be sending out a final copy?

Boehm: What is your...it's going to take me hours now.

Bernstein: I know.

Boehm: Worse case, I would say I could send you a draft at 8:00...something like that.

Bernstein: Okay, perfect.

Boehm: Now, are you going to be there today? Mail it or what? I could email it to you if you want. That would be easiest.

Armstrong: Then we're going to need some prints, right? Some signed copies?

Boehm: No, all you have to do...

Bernstein: Is verbally.

Boehm: All you have to do is [] that this is your invention; and when you go to read it the second time and sign the declaration, that you won't make any changes to the spec, and that was your invention the date that we filed it.

Utley: You can send one to me at my home.

Bernstein: And send one to Jim.

Boehm: But do you guys want another pass tonight.

Bernstein: Another what?

Boehm: Another pass at it. Do you want to re-read it?

Bernstein: I do. I absolutely will re-read the changes. I'll have Jim re-read them, and by 9:30 hopefully we'll be done reading it and be done.

Boehm: Okay, I'll see what I can do to push this through then.

Bernstein: Cool. Hopefully it'll just be a re-read and we'll say it's right.

Boehm: Yeah.

Bernstein: Because if something jumps at us...

Boehm: How do I get it to you? Do you want me to fax it? I want to email it. That's quicker for me.

Bernstein: Great, email it.

Boehm: To whom? Where? When?

Bernstein: Eliot@iviewit.com, brian@iviewit.com, and jim@iviewit.com.

Utley: No, send it to me at...<end of tape>



Lorraine Christine Hoffman, Esq.
Assistant Staff Counsel
The Florida Bar
File No. 2003-51, 109(15C)

**Exhibit G – Foley and Lardner, Christopher Wheeler and Iviewit
Representatives Taped Transcripts 8/4/00**

Transcription of Patent Meeting
Conducted August 4, 2000

Participants:

Eliot Bernstein, Jim Armstrong,
Brian Utley, Steven Becker, Simon Bernstein
Docket 57103-120

Note: *Square brackets [] are used to indicate inaudible or indecipherable text. Text found inside brackets indicates transcriptionist's best guess. Since speaker names are not specifically identified, transcriptionist has made an attempt to identify based upon comments made in conversation but cannot guarantee that each speaker has been accurately identified.*

Armstrong: I know you probably are, but we [] made aware of all of our deadlines and contingencies relative to those deadlines [] that we're not left with...I was a little surprised that a final pack that's been in the works for a year, and I know you weren't involved for a year, but in the works for a year required that Eliot and I spent the entire night and morning reviewing it in order to get it done.

Bernstein: What bothered me about that as well is that we'd go through the math, and then suddenly you have a document Brian sent you several days earlier regarding the math that has a bunch of changes in it, and none of that's in there. I mean, I don't understand that.

Becker: ...was changed from that document anyway.

Boehm: Yeah, it was changed from that document anyway. I was working with Brian, who I thought was the master of that math, but...

Bernstein: But he had sent you an updated map three days earlier that didn't appear in the final document that we were trying to...

Boehm: Okay, I don't know. Steve was handling that. I don't know whether...you know, Steve says he did put it in there, but then I don't...

Bernstein: But then we go through the document that we're filing, and it's not there.

Boehm: Okay, but we were on the third draft when I took it over. You guys had opportunities like crazy to...

Bernstein: But that's the thing. Brian had sent it to you earlier, and it still wasn't appearing in final drafts.

Boehm: If that's true, then something crossed in the email because Steve said he put it in there, and maybe there's a piece of the math missing between the crossing the emails. You're right in terms of...

Bernstein: Is Steve there?

Boehm: I don't know. He probably is.

Bernstein: And then my other question is quite a simple question my dad asked about electrical engineers being mathematicians and said, "Didn't they sit and pencil out the math of all this themselves?"

Boehm: Uh, huh. Here's what happened on that. Steve was filling the application. We worked with Brian and you, Eliot, on the application. In some of the letters and emails he said that he doesn't understand the math.

Bernstein: I'm not getting any of those.

Boehm: Huh?

Bernstein: I'm not getting any of those emails.

Boehm: Well, then, talk to Brian because we were corresponding with Brian on that, and I don't know why you weren't getting it if that was the

case, and I don't know which letter went to who, blah, blah, blah, but I do know that we mentioned that we didn't understand the math, and we were up to the third draft, if I recall; and you're right, Jim, that it shouldn't have taken...it shouldn't have been last minute and you should have had time to do it. I totally agree, but I can't take total blame for that...

Bernstein: But wait a minute. Steve has fundamental errors on understanding the math, and yet we're going to file it with him having math problems?

Boehm: It's your duty to either help us to understand...

Bernstein: But then I've got a point. We did help you. We sat on the phone for an entire day, walked through this...

Boehm: The day of the filing you mean?

Bernstein: And if this math is still wrong, I mean, there's something really fundamentally wrong here.

Armstrong: Let me check it again.

Bernstein: Yeah, let us call you back in a while. Is Steve in today, too?

Armstrong: I didn't get involved until Wednesday.

Boehm: Right.

Armstrong: I'll tell you one thing, Doug, that you should do as just a matter of course going forward. Eliot being the owner of the company and the person that Brian reports to is any future email correspondence should always be copied to him. That's kind of just a standard practice we all do in the company.

Boehm: To copy?

Armstrong: Yeah.

Boehm: Okay. I didn't know that.

Bernstein: You ask me to review and sign these patents, and you're not sending me information. What do you mean.

Armstrong: I think had we known that there was a question of validating Brian's math, Eliot would have brought me in a lot earlier.

Bernstein: I would have brought a mathematician in. I mean, this is ridiculous.

Armstrong: Yeah, I'm just a friend that's good at math, not a mathematician.

Boehm: Right, well.

Armstrong: Go to your meeting. We're going to check the stats out, and we'll talk to you letter.

Boehm: Well, you've got to talk to Brian, too.

Armstrong: Yeah.

Bernstein: I think because I now seriously have to report a lot of things to a board of people that we're going to have to have a meeting at some point either today or Monday with a few of the key people in the company who are investors, etc., so that they understand what they are investing or not investing in.

Becker: Don't jump to conclusions.

Bernstein: No, I'm not, but if this is correct, we've got some fundamental things that need to be discussed.

Boehm: If what's correct?

Armstrong: If he's correct about the math being wrong, but let's check it...

Boehm: No, I'll bet we could get a good patent if the math is totally wrong. I think we're barking up a tree here that's not a big wall.

Bernstein: But wait a minute. The question is if it still remains wrong and we gave you the right changes, it should have been filed right. All the sudden I'm left with a patent that...

Boehm: Okay, talk to Brian.

Bernstein: I will.

Boehm: Brian gave me the right changes. I filed what Brian gave me.

Bernstein: Okay.

Armstrong: Okay.

Boehm: And I don't mean to...you know...yell out of that, but that's what happened.

Bernstein: That's no problem. I totally hear that.

Armstrong: Thanks, Doug.

Boehm: Okay. Talk to you Monday.

<Hang up phones.>

Bernstein: 8/4/2000. 8:30 Doug Boehm conference call. Jim Armstrong, Eliot Bernstein. Steve, Jim, everybody, I'm taping the conversation, 8/4/ patent discussion regarding Docket 57103-120 with Brian Utley, Steve Becker, Jim Armstrong, Si Bernstein, and Eliot. Okay, guys.

Becker: [], too, if that's all right with everybody.

Bernstein: Yeah, did you get the fax from Jim?

Becker: I haven't received it yet.

Armstrong: It was sent actually to Doug on the "cc" line, but to a machine at 297-4900.

Becker: That's right. It'll go to our central fax department, and I just phoned up there and asked them to deliver that to me when it comes in.

Bernstein: Okay, but you've got the patent in front of you?

Becker: I don't. I don't, but I can get it.

Bernstein: Okay, well, let's do that.

Becker: Okay. I'll need a minute. I've got to go over the Doug's office.

Bernstein: Okay.

Armstrong: The fax is on its way to you now.

Becker: It's on the way to me?

Armstrong: Yeah.

Becker: Okay, then I'm going to put you guys on hold...

Armstrong: It's not done yet.

Becker: Well, I've got to go upstairs and get it, so hold on.

Armstrong: Never a dull moment.

Utley: They didn't put...they didn't put...

Bernstein: <Inaudible comment.>

Utley: And I did it again on Wednesday night.

Bernstein: And he said to me all these changes were in when I went through them at 11:15 at night with them. That all the math has been changed. I was looking at him and said these haven't been changed. He said, "No, I'm working on a copy that's been changed. I'm going to send it to Brian, and sign off..." So, well, now, again, we're back at this same thing. How do we change things? What effects does it have on us?

Utley: This has no effect. Mathematically, that's...

S. Bernstein: Were those faxed?

Bernstein: Yeah.

S. Bernstein: Okay. Nine pages.

Utley: But obviously this has an effect.

Bernstein: A huge effect because you have completely altered numbers.

Utley: Well, you could explain it; but the only way you could derive this is by having that be the square root.

Bernstein: But this is wrong that he missed this, and isn't that on your current math? Do you have your sheet that you did...current math...that he said he didn't have, had, whatever? Brian, do you have the patent book?

Utley: Yes.

Bernstein: Okay. I need to borrow that.

Armstrong: I would think that in a patent document being as important to us as it is, there's not an acceptable level of error. It's either got to be all right, or it's not acceptable.

Bernstein: Oh, and that's what we heard from Doug this morning. So, I mean it's hard to fathom this.

S. Bernstein: You know what guys? I don't understand. Why doesn't somebody... take five minutes, and tell me what...because I say it in a meeting with all the lawyers, and...

Bernstein: Here, Dad, let me give you an example. Is 2,560,000 times .8 the same as 2,560,000 times 1.25? Yes or no?

S. Bernstein: I doubt it!

Bernstein: Okay, well, that's the issue. That's how far off these are.

S. Bernstein: Okay.

Becker: This is Steve. I'm back, and I can't seem to find that file. Doug is out today. You guys may know. So, I don't know how much help I'm going to be.

Bernstein: Okay, well, do you have the fax? Hey, D-Man, you've got the file right there. Just email it to him.

Becker: Here it is. I've got the fax now.

Bernstein: Okay. Steve, Doug also mentioned that you had emailed some correspondence to us that you didn't think the math was right earlier? I have no records of any of that.

Becker: No, what I did was I faxed the draft over on Monday night, which incorporated some additional disclosure that Brian had sent. Basically, it was examples. It had the equations set out for both print film and digital examples, and then he had three examples for print film and one example for digital, and I essentially...I exactly basically cut and pasted that into the application.

Bernstein: Well, the application we got from Doug didn't have any of that.

Becker: I don't really know because at that point Doug was down there with you guys, and I presumed you were reviewing it on like Tuesday and Wednesday. And the Doug said he would take care of just...because we figured there would just be some minor changes after we'd incorporate all of that.

Bernstein: Well, it wasn't incorporated, so there were huge changes.

Becker: Oh.

Bernstein: And it would have been filed completely wrong had it not been for Jim Armstrong reviewing it. Everybody would have nodded off on this and accepted wrong, completely wrong, filings.

Becker: Maybe he should be part of this conversation.

Bernstein: He's on this conversation.

Becker: Oh, good. Hi, Brian.

Utley: Hi, Steve.

Bernstein: Brian's here and Jim Armstrong's here.

Becker: Okay. Well, the only link we're missing here is Doug because Doug took the last few steps of incorporating comments and actually filing the application on Wednesday.

Bernstein: Hey, E...E-man, forward him a copy of the final draft, would you?

Armstrong: And that, Steve, I think the most important question to have answered is what are our rights and obligation and opportunities to correcting this without any ill effects to us?

Becker: Yeah. There's plenty of opportunity essentially. We can file...if there are substantial errors in the application as it was filed, we can simply file a new application as soon as we get those fixed either on Monday or Tuesday or what have you. The goal of filing on Wednesday was to maintain priority back to the provisional application, which was filed a year ago.

Bernstein: So, did we lose that if they're wrong?

Becker: No, because we can only claim priority back to the extent that the subject matter was originally disclosed in the provisional filing of August 2nd of last year, and none of these equations were filed back then.

Bernstein: But the original process was.

Becker: Right. And the original process is the [] in the application. We're just talking about the details of the math examples that are in here. So we haven't lost anything.

Bernstein: Will we lose claiming back to the priority of the original provisional? So we did lose something, or am I incorrect in what I'm hearing.

Becker: No, we didn't lose...the original provisional can only provide priority for what was originally disclosed, and the math was not originally disclosed, right?

Bernstein: Well, no, but the math is a subject of the invention, not vice-versa.

Becker: The reason I'm putting the math in there is essentially to provide concrete examples...

Bernstein: Of the invention.

Becker: Right.

Bernstein: But the invention was in there as of the priority date, and we had already talked with Chris Wheeler and everything regarding this. Were you on that conversation?

Becker: I don't remember.

Bernstein: Well, Brian, you were on that conversation. It's the conversation where we were going back to try to get the soonest date on the filing and correcting the provisional to encompass all of these things.

Utley: Well, you can't correct the provisional, but you can...what it does is it claims back for everything that references back to the original, but then incorporates all the new elements to bring it into...to make it into more of a complete statement.

Bernstein: I'm not sure I understand this. It was my understanding that we were going back to Ray [Joa's] patent and fixing it by inserting what we

have here. When I talked to Doug, that was what he was under the impression we were going to do, and now that's all changed as of today.

Becker: You really can't fix a provisional application.

Bernstein: Not the provisional—the regular filing of August whatever-whatever day it was.

Utley: No, in March. March 24th.

Becker: Oh, okay. Yeah.

Bernstein: And that way, if that patent gets approved with all this in it, that's what we were doing, and we wanted that one to be approved first correctly because it obviously expedites our life by a long way.

Becker: This is the PCT application file of March 23rd. Is that what we're talking about?

Utley: Yeah, but the way that I recall the conversation, the spec cannot be changed...

Becker: Right.

Utley: ...but the claims can be.

Becker: Right, and they can be changed as long as they're supported by teachings that are in that specification.

Utley: Right.

Becker: Which is why you really...

Bernstein: And the specification can't change?

Becker: Right.

Bernstein: Why?

Becker: Because it would be kind of like...

Bernstein: I thought that was based on new matter.

Becker: That's exactly it can't be changed.

Bernstein: So it can be changed if it's still the same matter?

Becker: The claims can be amended as long as they are still fully supported by the matter that's in the specification that's originally filed. Now, if you want to change your claims and they're not supported by the specification as originally filed, then you have to file a whole new application adding new matter to your specification that will support those claims.

Armstrong: Does the fact that a direct interpretation of what in general amounts to typos and oversights, but a direct interpretation of that affect our ability to change that supporting matter of that matter? Because if we directly interpret the math in the certain circumstances here, it will bring you to a wrong conclusion if it's a direct interpretation without having to reverse such an error but was meant to occur.

Becker: Well, I see. Then we need to get the math right, but it doesn't affect our priority. Only by a few days essentially.

Bernstein: Well, do we lose the ability to claim priority to what we were trying to claim here...

Becker: No.

Bernstein: ...by that date? So you can go back in and change the matter of this?

Becker: You don't go back and change the matter, you just file a new application which claims priority back to a prior application only for the subject matter that was...

Bernstein: But we missed that application.

Becker: No, we've got it in the form of this continuation, or this PCT, that we filed claiming

priority back to that patent application. So we've preserved that chain of priority.

Armstrong: Are then completely confident that errors that we need to correct right now then are not going to hurt us in any way, shape, or form as being able to claim as part of our invention all of the correct things that we want in there?

S. Bernstein: That's what I heard at that meeting, that we could go back and re-do that at a later date without having any implication.

Bernstein: As long as it wasn't new subject matter.

S. Bernstein: Exactly right. These are just corrections to the...

Bernstein: They're corrections, they're math, whatever.

S. Bernstein: Okay, but we're not saying this is a new way to get to that.

Bernstein: No.

S. Bernstein: Okay, that's what I heard. That's the notes I took. Eliot, you should have that on the tape recorder so that we know that.

Armstrong: Well, we do, and that would also support, I think, another issue, which is that we now have to go through the refiling of something else which was originally corrected several days ago and was somehow ignored so that this whole refiling shouldn't even cost us anything.

Bernstein: Well, and beyond that, Doug <sic>, what I'd like to really get down to is a letter from you, in writing, explaining all of my, you know, both from the Ray [Joa] patent forward, and I think you need to talk to Doug about it, of what our potential pitfalls are here with these filing errors, what our potential pitfalls are, what it caused to happen with that priority, priority equals, and if there's any harm to us. Because we keep just slipping back by these things. This

should have been right. I mean, we have well documented, and Brian's well documented, that these changes were sent, and now we've missed a priority claim to that by not being able to go back and change our last filing. I need to know the liability here.

Becker: You know, I was not there on Wednesday night. Brian talked to Doug on this and then made final changes, and then...

Utley: Yeah, Doug sent me a next-to-last copy, which I went through and there were a number of errors—I have my notes on each one of those at home—and then I reviewed each one of those with Doug, agreed on what they were, and then Doug was going to send me the last copy, which apparently he didn't because I never received it. At that point in time, it was, I guess, about 11:30 or 11:45 our time.

Bernstein: And these were also discussed in great length with him for a whole day on the phone.

S. Bernstein: Yes, well, how about in the...

Bernstein: No, no, Dad, this is separate. But at great length this was discussed, every one of these changes.

Becker: The changes you sent me here, is this Brian's handwriting?

Utley: No, some of it isn't correct.

Bernstein: Well, let's go through it because I'd like to...

Armstrong: Yeah, let's go through it.

Becker: I don't know if that's going to help that much because it's a question of what actually was filed and whether it incorporated the changes that Brian asked for the last minute.

Bernstein: It didn't.

Armstrong: We know that. This is what was filed.

Becker: Brian, didn't you just say that Doug didn't send you the final draft of what was filed?

Bernstein: He did it the next day.

Becker: Oh, he did the next day?

Armstrong: Yeah, Jim, can you forward that to Steve real quick?

Armstrong: What?

Bernstein: Email it to him...the final draft?

Armstrong: Yeah.

Becker: Well, I'm not going to question...

Bernstein: Okay, but we need to go through and get the changes acknowledged, accepted, have you put it into the next whatever you're going to do to solve this, with a letter explaining what we've lost here.

Becker: All right.

Bernstein: Okay. Any liability, potential liability where we're exposed to from this.

Becker: Oh, I wouldn't worry about it. You guys are making a mountain...

Bernstein: Well, you know, I gotta tell you, I worry a lot about it from what Doug told us. So, you know what I mean? You tell me not to worry, but then you tell me it's very important that we're accurate in this filing; and then we're very inaccurate in the filing, and then we're not supposed to worry. I'll feel much better not worrying with a letter from you explaining why I shouldn't worry.

Armstrong: Steve, what's at your email?

Becker: Sbecker@foleylaw.com.

Armstrong: Sbecker?

Becker: Yeah, "S" as in Steven, "becker."

Armstrong: Got it.

Bernstein: Okay. Let's just go through this with you, Steve, so we can get the next step done.

Becker: All right.

Bernstein: Which is correcting the issues. Are you with us on page 13?

Becker: Right.

Bernstein: Okay. Jim?

Armstrong: On page 13, line 19, the expression of VWH should follow the way we express it in our definitions, which is VIH. Even though the two are equal, let's just follow the way that we have it expressed in our definitions on page 12.

Becker: Oh, I see. Okay.

Armstrong: Then on line 23, each of those expressions is not congruent with the way we've defined them. Despite the fact that we arrive at the same results, it doesn't apply the formula in exactly the same way. So for a reader, it ought to be the same. So for line 23, it should be the "square root of 2,560,000 times 1.25."

Becker: All right.

Armstrong: Okay. Not "2560 divided by .8."

Becker: Okay.

Armstrong: On line 24, it ought to be "1789 divided by 1.25."

Becker: I see. Okay.

Armstrong: Then on line 25, it ought to be "1441 divided by 4." Again, the results are the same; the expressions are not.

Utley: No, that last one, Jim, it's correct.

Armstrong: It's what?

Utley: The scan density is 1789 divided by 5.

Armstrong: Okay, hold on. Scan density is defined by us as being...where the heck is it...oh, it's right up above..."target image height..." right up above on line 7..."minimum scan density is target image height," which in this case we just defined to be 1431...

Utley: Where are you reading from?

Armstrong: Line 7 of the same page. Line 7, page 13. So target image height is 1431 divided by the source image height, which is 4, so it should be 1431 divided by 4.

Utley: Well, the...I guess that that equation, "MSD equals TIH/SIH," did not come from my documentation.

Becker: Hold on, let me look at this documentation. I've got it right here, too.

Bernstein: Well, Steve, you have copies of this, too, that were sent to you...

Becker: Right.

Bernstein: ...of what Brian's looking at, several days ago. So how isn't this stuff flowing forward into the patents, especially when we pointed it out two times before filing? I mean, I'm just dumbfounded at this.

Utley: There was a change, Steve, which you were not involved...

Becker: The proper equations, that wasn't there the last night when the last changes were put in, so I can't really speak to it.

Bernstein: No, but he sent you his changes several days ago.

Utlely: Steve, there was a change that we decided on on Wednesday afternoon, which was to reflect aspect ratio as width divided by height, which I made, and that was created by the desire to reflect aspect ratio the way that displays are expressed as opposed to the way photographic images are expressed. Photographic images are expressed the opposite way, and that's the way the documentation had been originally prepared. But it was thought that it was perhaps more consistent with current technology to express it the way that displays are expressed. So I went through and changed...

Becker: You mean from that change in [invention? convention?]?

Utlely: Yes. So that caused the equations to be reconstructed to reflect the inverse of what was there before because the affect ratio now is inverted.

Becker: I see.

Utlely: And what happened was Doug apparently did not pick up all of those changes, even though I went through them very methodically the last thing Wednesday night when he sent me his almost-final draft.

Becker: I see.

Utlely: And, Jim, just for your edification, that also affected the MSD shifting from a height to a width orientation. The number is the same, but it changed it from a height to a width.

Armstrong: So what's the correct formula for MSD?

Utlely: It's TIW/SIW.

Armstrong: Okay.

Bernstein: So, you made this change with Doug, and it's still wrong in the patent?

S. Bernstein: I'm a little concerned about the proficiency of the legal aspect of this. We sat there for hours, and then Brian stayed late into the night with this guy, and then he comes back and we don't file it right anyway? It seems like there's something wrong here. I mean, ...

Bernstein: I mean this is, yeah...

S. Bernstein: I mean, I'm just budding in because I have little or no knowledge as to what the numbers mean, I'm just listening to a conversation in which I'm hearing is that after four or five hours in a room locked together with lawyers and everybody else, we reach an agreement that those changes will be made. No, my understanding is Brian stayed and made those changes, and then the lawyer didn't file the changes? What's the sense of that?

Bernstein: These are good points. Let's move forward, Jim.

S. Bernstein: These are points that have to go back to stockholders with money invested.

Bernstein: That's why I've asked Steve to send us a letter of what's happening, what our exposure is, by Monday or Tuesday, explaining how this didn't occur, get in, and what we're going to do to resolve it, and what that resolve initiates in the chain of events.

S. Bernstein: Well, the other side of it is this. If after all of this precaution has been taken—and Brian, you can correct me if you think different—but after all of this precaution has been taken, it appears that the fallacy of worrying about it ever gets accomplished. Brian stays, everybody works on it, it's still filed wrong. Now what if Jim Armstrong hadn't caught it. Brian was on a plane today...

Bernstein: Then none of Brian's changes even sent several days ago even would have been in there. Math would have been wrong, equations would have been wrong, verbiage would have been wrong.

S. Bernstein: Am I right, Brian, in having this concern?

Utley: Well, yeah, obviously it's clearly a major concern because there's nothing more disciplined than the mathematical expressions.

S. Bernstein: And you're comfortable that what you did, even if some of them were wrong, that we could have later corrected...

Bernstein: No, Dad, we sat here with Brian and Jim and Doug, and we went through it, and we all agreed it was right, and those changes do not appear.

Utley: No, we...

S. Bernstein: That makes me very nervous. Well, it makes me nervous to the extent that are all of the other patents done right?

Bernstein: Well, that's what I'm...I'm going to start having somebody review all of this. I mean, obviously there's...it opens up a whole can of worms.

S. Bernstein: Well, the other thing that I heard was—and not negatively or anything else—but I heard that perhaps Ray [Joa] did this work and he was either concerned about it being a bit sloppy, blah, blah, blah, blah. What is the excuse for this law firm?

Bernstein: Well, let them write us what's happened here. I mean, I definitely need to see on paper, Steve, some kind of report on this. That it describes what occurred, why it's not reflected in the patent filings, and what our exposures are, and that'll tell us what we're dealing with in firm, etc., liabilities. I mean, we don't know that.

Armstrong: We should continue to look at the changes so that he's copy that reflects everything.

S. Bernstein: Well, even if there is no liability, what I'm still concerned about, even if it can be corrected, it's the exact same position—Brian, am I right?—that we found ourselves in with the last lawyer who did it. Okay, thank God we can make changes, but that isn't the answer. Why not just get it right, get it filed...

Bernstein: No, don't just say thank God we can make changes, Dad, because all of that brings additional liability to you. You miss dates, you miss claiming, you miss this and that—words that are very tricky and confusing, and only these guys can understand. So that's why I need it to be put in writing so I can have it analyzed...

S. Bernstein: Absolutely, I want it definitely, because I need to take it...you know, I need to have board member approval...

Bernstein: Oh, I think our board is going to be disastrous with this stuff about several things when we take this to them. And we need to know from the Ray [Joa] level to the Foley-[Larver] level, how this is going to be cleared up and what the problems were that occurred.

S. Bernstein: Okay, let's get that part in process; and it's unfortunate that Doug's not here because maybe it's something he could explain.

Bernstein: No, I talked to him this morning; and as a matter of fact, he said Steve had the math from Brian days before and by the time he got it, he thought it was all input correctly, and that was his excuse.

S. Bernstein: Well, what was he doing here with Brian?

Bernstein: Well, then we spent a whole day with him correcting it all so that it was right; and then by filing time, none of it was right. So, let's

go forward. Let's just stay on track. We'll deal with all of these issues on Monday.

Utley: I just say one thing. The most important part of the math is all of the definitions. The examples are examples; but the most important part of the math are the definitions.

Becker: Okay, are those right?

Armstrong: No. Well, there's one that's not, which is []. Line 7 of page 13...

Bernstein: Is wrong.

Armstrong: Is wrong. It should read...

Bernstein: ..."[] equals TIW/SIW."

Utley: They are mathematically equal. Both will give the same results. It's a consistency question as opposed to an accuracy question.

S. Bernstein: And for a reader, it would probably be easier to be consistent.

Utley: Absolutely.

S. Bernstein: That's what we want. As long as we're spending all of this money and everybody's devoting their time to it, we want it to right—as right as you can possibly get it at any rate.

Bernstein: Okay, Dad, let's move forward.

Armstrong: That changes one thing on line 25. The expression on line 25 is now correct as it was typed, so scratch out my handwriting. Okay? All the other corrections stand as I explained them earlier. Now, on the last line of this page, that should read: "480 X 320."

Utley: That's correct.

Armstrong: Okay. Then on line 6 of page 14, I think we should consistently state which is width and

which number is height because it's such an important distinction in the calculations. We did it on the previous example, but not on this one.

Utley: And that is what we had agreed upon on Wednesday afternoon.

Armstrong: Okay. Line 17, again we're just missing that square root symbol in order to make that equation work. Without the square root, it's millions instead of thousands. Now, in line 19, I had originally indicated this was correct; it's now incorrect because of our change in the formula for the density for the maximum scan density.

Bernstein: Steve, are you getting all of these?

Becker: Yep.

Armstrong: This should now read in line 19: "1789 divided by 5 equals 358."

Becker: "1789 divided by 5 equals 358?"

Armstrong: Yes.

Becker: All right.

S. Bernstein: Steve, I have a question to ask you.

Becker: Yes.

S. Bernstein: When Jim or Brian or anybody gives you these numbers, are they checked out by anybody, or do you just copy what we say and that's it?

Bernstein: No, they definitely don't copy what we say. That's an initial problem here, Dad.

S. Bernstein: Okay, I don't mean to be sarcastic.

Bernstein: No, but they would normally as mathematical people add up the equations.

S. Bernstein: Yeah, because your partner was telling me that most patent lawyers are engineers, which would

lead me to believe that somebody would say, "well, I better check the math to make sure that guys who are not engineers know what the hell they're talking about." Is that done by your firm, or is it just accepted as gospel what we give you?

Becker: We don't have engineers or technical people check the math that you provide us.

S. Bernstein: Okay, so what we provide you, then, we live and die by?

Becker: Okay. Your job is to get that right.

Bernstein: Right, but what we did give you, you didn't provide in the patent.

S. Bernstein: Okay, we're trying to say the same thing.

Bernstein: Okay.

Armstrong: Let's just get it right. At this point we're only interested in getting it right. Line 27, that should be "36H" for the height.

Bernstein: Which page?

Armstrong: Line 14, third-to-last line of the page.

Bernstein: Okay.

Armstrong: Now we're onto page 15. Again, we just need that square root symbol as indicated there.

Becker: Okay.

Armstrong: Then there is nothing on the next few pages until we get to page 18, this is an important omission for our calculation standpoint, but we need that square root symbol.

Becker: Okay.

Armstrong: Then I'm going to skip for a second this discussion on minimum scan density here because I

want to talk to...go with Brian's comments, too, but on line 10, the correct figure is "1.33 equals 1.33."

Becker: Okay.

Utley: Yeah, that wasn't picked up from the other...from above, the aspect ratio.

Armstrong: Line 15, the square root symbol again is missing from that equation. And then finally, I don't see why, in this example, or any digital example where we have no scanning to do, why we should even include any reference to minimum scan density because the only application of scanning in a digital world is if we were to print a digital photograph and later scan it, in which case we'd follow the print formulas, not the digital formulas. So, my suggestion here is that we change the sentence, beginning on line one, to end after the word "dimensions"...actually, strike the words "and minimum scan density" and also to eliminate line 23. Do you agree, Brian, that there's no reason to have that there?

Utley: It certainly doesn't anything. It doesn't subtract anything.

Armstrong: It just added confusion to me as a reader when I thought, "How do I calculate that?" and then realized it's not...we're not scanning anyway. Why ask someone to determine something that is not included as a step of the process? So I think if everyone agrees, we should strike the words "...and minimum scan density" in line 1 and 2...

Utley: No, what I would do, I wouldn't do that. What I would do is simply say, "...image size and dimensions" and then add a new sentence which says, "Minimum scan density is not required since we are dealing with a digital image."

Armstrong: That's fine, too. Then let's strike line 23.

Utley: No, I'd leave that in.

Armstrong: It's redundant, but that's okay. Do you see any other problems with the formulas? Did you review all of this again today, Brian?

Utley: I've not reviewed anything today. I wasn't aware of the problem until about three minutes ago.

Armstrong: Okay. So that covers my comments on that.

Bernstein: And, Steve, do me a favor. When you guys draft this letter, draft it to Si and Brian. Okay? I'd like to be cc:'d on...and by the way, I'd like to be cc:'d on any correspondence of anybody to do with the patents.

Becker: Okay.

Bernstein: One last thing. Doug mentioned that you had a file from Brian, a spreadsheet that part of the spreadsheet matter is not incorporated in here. He didn't know why...he couldn't explain why. I was wondering what that matter is, and where is it? Are you aware of that? Because he referred to you.

Becker: Did he?

Bernstein: Yes.

Utley: That's probably the image sizing spreadsheet.

Becker: Image sizing?

Utley: Yeah, I sent you two files on Monday.

Becker: Okay. Actually, you sent three all together. Oh, you sent three emails, and then the last one had two of them.

Utley: Right, the last one had two files: both the image sizing and the process.

Becker: Oh, you're got the macro, and then you've also got the description of the math. Now, what did you want included that wasn't?

Bernstein: Well, Doug said it should have been included, but it wasn't...the rest of that sheet.

Becker: What?

Bernstein: I don't know. Whichever half's missing.

Armstrong: Hold on one second...I don't want to confuse Steve. We do not want you to cut and paste out of those documents into the patent filing. Those documents do not reflect the way we want to express the math.

Bernstein: Right, but we might want them in there, B, correctly.

Armstrong: What?

Bernstein: We might want them...

Armstrong: They're not in there correctly. We just went through it. It's now correct. If he employs all of the changes we just all agreed to...

Bernstein: No, but there's another sheet that's not reflected here.

Armstrong: Well, yes, I do want to talk about that. The macro, right?

Bernstein: Right. Can you forward that file to us—the Excel sheet—to Jim, me.

Armstrong: Just have Steve forwarded the whole email back to you.

Bernstein: Well, he doesn't have it in front of him, and Brian's got it right here.

Utley: No, I sent it to you. You were copied on it.

Bernstein: Okay. Let's just get the most up to date...any changes.

Becker: Yeah, Brian, remember, we made a decision not to file the claims directed to your macro—we made that decision last...a week before the...

Bernstein: Why?

Becker: Because it was going to involve some additional work, and we didn't have time at that point; and it was all new matter that wasn't going to claim priority to anything, so...

Bernstein: Well, what's new matter? If the math is part of describing the invention, then it's not new matter, according to what Doug's told me four times now.

Becker: Well, Eliot, as you recall, you always have to look at the claims of the application, and that defines the scope of your protection. The claims will also define...also have to be supported by specifications. We were going to direct claims to the idea of using...of having a macro program, which is useful as a tool, to do these calculations in a rather simple process.

Bernstein: Okay, that's fine if you want to just claim a macro. That does it as a simplified process and add that as an additional patent for us, but the underlying math of it should all be applicable to the invention since it's just derived off the invention.

Becker: Yeah, math...

Bernstein: So it's not new matter, it's just an understanding of the matter. I mean, I swear we went through this four times the other day with that conclusion.

Becker: There are two files that Brian sent me. One of them was an Excel spreadsheet having six pages, and all of that material was included in the application in pretty much cut-and-paste format. His pages 2, 3, 4, and 6 were the examples, which I just cut and pasted as soon as I got them from

Brian because they defined it all very particularly.

Bernstein: Okay, now you need to get back your record of that because 2, 3, 4, 5, and 6 that Brian is sitting here showing me, were never in these patents yesterday. So cutting and paste, you must have put them in the wrong document.

Utley: Those are the examples.

Bernstein: But those weren't...that's not what ended up in there.

Utley: They pulled these pictures out and put them as a figure sheet on the back, and then re-entered...

Bernstein: Wrong math.

Utley: ...the formulas in the body of the...

Armstrong: Hey, right. B, are those images...are you looking at the figures? Are all of these figures in the patent application.

Utley: We should be on figure 7.

Bernstein: Steve, figure 7?

Becker: Okay.

Bernstein: Are you looking at it?

Becker: Not in front of me, but I recall writing it.

Bernstein: Jim, figure 7, what do you see?

Armstrong: I don't have a figure 7...because that was part of...that didn't come in the patent application, but [].

Bernstein: It's not part of that final patent?

Armstrong: I don't know about that, but it didn't come as part of that Word document.

Bernstein: That's supposed to be the final revision of the patent.

Becker: We have to scan the drawings into a Word document; so if you just mailed the Word document, you probably didn't get any figures yet. Probably the figures were left off of that.

Bernstein: Okay, do you have your patent application?

Armstrong: I've got the one we reviewed on Tuesday.

Bernstein: And what's in there?

Armstrong: All the figures.

Bernstein: Right or wrong?

Armstrong: You know, I don't know. I didn't...Brian, was figure 7 changed at all with the restatement of our aspect ratio?

Utley: There were some additions that I made for clarification purposes. If you look at the first page of the imaging process, where it says, the third box down, it says "viewing image," I inserted "SIR less than DWR" to tie it to the equation above it. And then in the one, the bottom, it has the expression "SIR greater than BWR," again, tie it to the equation above it.

Armstrong: Yeah, because those two don't have a distinction, figure 7 as it is now.

Utley: Right. So that simply ties the image to the equation.

Armstrong: So do they have...have you sent them an updated amendment?

Utley: Yeah, that went out late Wednesday afternoon.

Armstrong: Okay, we've just got to make sure that the corrected figure 7...

Bernstein: Steve, can you fax us the file patent?

Becker: No, I can't find it. I guess Doug took care of this from...

Bernstein: Does his secretary have a copy?

Becker: ...Monday night on. I spoke with her, and she wasn't clear...she wasn't able to find it.

Bernstein: Do we have a filed patent?

Becker: How certain would you like me to answer that question? I mean, Doug sent me an email saying we filed the patent.

Bernstein: Well, what he sent me that he said he filed is missing the diagrams. So, I have a final patent document missing...

S. Bernstein: When is Doug available?

Bernstein: Yeah, does he got a cell phone or something?

Becker: I don't know. I don't know. Maybe I can help clarify this...I mean, Eliot, you sound like you're really upset at us.

Bernstein: You know, I'm not a person to get upset until I see that I spend a lot hours going through this, Brian spends a lot of hours, we make all of these global changes...

Becker: Eliot, I've heard that a couple times already. Let me try to explain a little bit about patent law and maybe help everyone understand what has or has not happened. Okay, there's a lot of rhetoric being thrown on there, but there's...

Bernstein: Yeah, because we're blind.

Becker: I don't think all of it has a lot of basis in patent law.

S. Bernstein: That's good to hear, so let's hear that.

Becker: Okay, and Si, I thought you in particular might be interested to hear that.

S. Bernstein: Yeah, that's, you know, I'm not sure that adds any comfort because maybe what you're saying is it's not an exact science and then you move along...

Becker: Well, I'm going to go well beyond that.

S. Bernstein: Okay.

Becker: Does anyone have a copy of claim one they can read off of?

Bernstein: Yes.

Utley: This is only a piece of it, right?

Bernstein: Yeah.

Armstrong: It's 22.

Becker: I'm working off what you emailed me, Jim, and I see page 24, lines 1 through 7. I guess they could have repaginated, but...

Armstrong: Oh, but Eliot had mailed you...or faxed you...

Becker: I'm sorry, what you emailed me.

Armstrong: Oh, okay. So it's changed then. I don't know why, though.

Becker: On the top of the page says "What this claim is."

Armstrong: "What this claim is"...

Becker: Do you have that?

Armstrong: Yes, page 22 in my printed on.

Becker: Okay.

Bernstein: Okay, hold on one second because I want to get my notes.

Utley: What page is that, Jim?

Armstrong: You don't have it, Brian.

S. Bernstein: Because I don't have 22.

Armstrong: Want me to fax it... email it to you?

S. Bernstein: No, that's okay, he's going to explain it to me. I want to see if I can't understand this.

Becker: Sure. It's very sort claims, seven lines long. It actually defines the scope of the patent protection that we are trying to obtain in this filing.

Armstrong: Who are we waiting for, Eliot?

Becker: I think so.

Bernstein: I'm up front. We're waiting for Brian again.

Becker: Let me know when you're ready.

Bernstein: Okay, Steve, Brian stepped out for a minute, but I still want to address this issue. We invent something. I hire a mathematician. The mathematician solves the X, Y, and Z of the invention. Does he claim a new patent for himself?

Becker: Probably not. [Inventorship] typically follows with the invention. If somebody else figures out how it was done, generally speaking that would.

Bernstein: Well, I want to be very color on this because Doug's thinking...I don't even know if then the next statement is correct or incorrect, but if a macro was created using the math that comes from the invention, where does it follow? Brian, I just asked him, if I hired a mathematician to do the math, put all of this into a thing, where does this follow. He says the invention, the inventor, etc. The guy you hired to do math wouldn't claim a new patent or a new invention, which is confusing to me because Doug now, as of this morning, told me that you're planning on

filing a separate patent as inventor of a macro that just spawns off the math entitled to this invention. So I'm confused, and I want to be very specific on this of what our strategy is here on all of these peripheral pieces.

<End Side 1; begin Side 2>

Bernstein: Why don't you explain that to me again.

Becker: Can we go ahead with describing the claims?

Bernstein: Well, do you want to just finish that real quick, and then we'll go right back to the claims?

Becker: Okay, now what was the question you posed me, Eliot?

Bernstein: I hired a mathematician to solve for what I did. He comes up with an equation. Where does that equation belong? Does it belong filed as another patent? What's the inventorship, so to speak? And then, I design from that math a macro that solves that math with input formula. How should we be protecting that the whole way through, because I seem to be very confused about what I'm being told each day.

S. Bernstein: Okay, let him answer the question.

Becker: Inventorship follows whoever conceived the invention as claimed, and that's why the claim is so important because when you set forth in your claim what it exactly is that you're claiming, you have to ask who conceived of that idea—who was the first one to come up with it. So, typically if somebody really reduces your idea to equations that describe why it works or how it works, typically they would not be named as a co-inventor because they really didn't invent the idea. Now if you wanted to claim a macro which has user-input displays for receiving certain data that can be used by, say, a technician to determine the scan density of a print film image that would allow for the desired enlargement ratios and the desired target image size, that kind of is a separate idea, and that's why we

thought it would be useful to claim that as a tool as well.

Bernstein: Okay, and I understand that part. I don't mind claiming that all day long.

Becker: Brian really was the one that built that and came up with it. It's based on principles that you learned, you know, a few years ago that maybe you didn't understand the math behind them, but certainly, I would think, be named an inventor on that.

Utley: I think that would probably claim both myself as it relates to both aspects.

Becker: Right. But the important thing with the patent office is that it is...the patent office realizes that it is a bit of a grey issue in terms of who conceived what, so the important thing is not to have any deceptive intent.

S. Bernstein: I think the most important thing is the distinction between inventorship and ownership. As I understand, all of this, every one of the patents that we have filed, all rights, title, and interests are iviewit's, regardless of who the author/inventor is; and any revenue stream derived therefrom are iviewit's, and that's the important thing. Is that true, despite and in light of the [__]? My very next question, because we could put anybody as an inventor; but as long as that doesn't entitle them to a disproportionate share of any revenues derived therefrom, then I don't care.

Becker: Yeah, inventorship or ownership initially vests in the inventor or inventors who are named in the application; but typically, inventors are under some obligation to assign to a corporate entity, either written or by cause of their employment—and you can get into the issues of shop right...you know, if somebody invented something on the corporate time and then went and...you know, it wasn't really part of his job description, I know this issue's going to be a

little more tricky. But I think in this case...what we do typically as a practice to confirm ownership is to have the inventors sign a written assignment document over to whichever corporate entity they want to...

S. Bernstein: But haven't we followed that?

Becker: We've got those documents. I don't think we have them all signed and filed yet.

S. Bernstein: Let's get them.

Utley: Well, Doug was doing that on Tuesday while he was here.

Becker: Okay. Did you do some signing of documents, Jim and Eliot?

Bernstein: Yeah. Right.

Becker: Okay, so that's in process.

Bernstein: Okay, and wasn't really the intent of my question. The intent of my question is to define, for my understanding, what should claim back to Ray [Joa's] patent, and that means that everything other than a macro shell should define back to the original patent and be filed, corrected, amended, however we get it in to the original patent documents since none of it's new matter, it's just an explanation mathematically on every equation of what happens.

S. Bernstein: That's what I heard at the meeting.

Bernstein: And that is exactly what I've heard, repeated; and then this morning, it was completely opposite, and yesterday it was a little opposite—a little—and, you know, I've become very confused about which strategy we're taking, which road, because we decide something, and then it's changed, and we're doing something else, and I'm completely lost.

Becker: I think I can make this very clear for you if you'll give me an opportunity.

Bernstein: I will.

Becker: Let's take a look at claim one. Claim one states that what you're claiming is a method of providing a digital image file for viewing on a user display in a viewing window that has a predetermined size, and the method includes one step. The step is, very broadly stated—so bear with me here—providing a digital image file having a image size comprising a fixed number of pixels representative of an image wherein that image size is greater than that of the viewing window size. Now the broad concept that we're trying to claim here is being the first ones to provide a digital image file that has more data than is needed for the window size. And why are we trying to claim that? Because that allows you to zoom into the image without pixelation, and it allows you to pan around the image to corners that maybe are not shown in the original viewing window. Does everybody understand that?

Utlely: I think so.

Armstrong: Yes.

S. Bernstein: I think we're on the same line.

Becker: Okay. So now the question becomes: Did we support that claim with relevant descriptions in the specifications. And what's our standard? Our standard is that we have to provide enough disclosure in the specifications to enable somebody to make and use that invention as claimed. This person needs to be somebody of ordinary skill in the art—in other words, somebody who can read this document and maybe has some technical background in imaging or image processing, for example, and can read what we've put in our document and can perform our methods claimed. Okay? Everyone with me so far?

Bernstein: Um, hm.

Becker: So we look back into the document that was filed on Wednesday and we say to ourselves, "Did we provide enough information in that document to allow somebody to teach somebody how to make and use a digital image file that has an image size greater than the viewing window size?" And one might argue that stating the solution in itself almost provides enough information to one of ordinary skill in the art to actually reduce this to practice and to make and use one. However, we've provided not only a description of several different ways of doing it, but also some examples, including math, that should make it abundantly clear to one of ordinary skill in the art how to do it. The test is whether it would require undue experimentation on the part of this fictitious person of ordinary skill in the art to make and use a digital image file having these characteristics. So the question you need to ask yourself with respect to this application is: "Okay, maybe there was an error or two in how it was expressed in examples or the number of pixels counted or division here or subtraction there, but was there enough in there to enable somebody, based on those teachings alone and, of course, their background, to make and use an image file having those characteristics?"

Utley: Okay.

Becker: And I think, based on a reading of it and based on what Jim just walked me through in these corrections that need to be made, that there probably was enough in there. That there probably is. I mean, we've described in several different ways how to do it with print film images or with digital images. We described in generally, and then we went and described it specifically.

S. Bernstein: Okay. Can I ask you a question?

Bernstein: Wait, Dad, because that still doesn't answer my question. That answers this issue here.

S. Bernstein: Let him finish with it.

Bernstein: Okay. Are you going to take this back to Ray's original filing on our...

Becker: Let me do that next, okay? Now, with respect to Ray's original filing on August 2nd of last year, we asked the exact same inquiry when we review the specification that we filed on Wednesday: Did Ray's filing back on August 2nd of 1999 provide enough disclosure and enough teaching to enable one of ordinary skill in the art to make this file?

Bernstein: And we have a lot of disputes on that because it doesn't even cover zooming.

Becker: Right, but what it does describe, if I recall correctly, is it does describe that you want to enlarge a print film image to a certain size and then scan it at a high density. Now it doesn't tell what density, it doesn't give a number of pixels,

Bernstein: It doesn't talk about zooming in on the image.

Becker: It doesn't tell the number of pixels, but it does show one way of doing it with a print film image. It doesn't talk about digital images...doing it specifically with digital images. It may refer to it generally, I don't know. But that is the inquiry.

S. Bernstein: If I hear you correctly, it is less important in the claim to say anything relative to zooming was in the claim to illustrate or to claim that the target image size is larger than the viewing image window because that is, in itself, your ability to have the zoom capability.

Becker: You're right. You can claim it all different kinds of ways. This was one way that we worked out in conjunction with Eliot and Brian two weeks ago. This is one of the ways we worked out claiming the invention.

S. Bernstein: Because ultimately zooming is simply a feature of the invention.

Bernstein: Okay, hold on one second. Steve?

Becker: Yeah.

Bernstein: When I look at Ray's claim one, "What is claimed: An apparatus for producing a digital image comprising a device for generating a digital signal file from a print film image and a processor for processing said digital signal file and for generating an image file wherein said processor generates a first signal file from said digital signal file, and further wherein said processor processes said first signal file and generates set image file."

Becker: Okay.

Bernstein: Okay, we all agreed that that is completely insane...to describe anything about our invention...whatever.

Becker: I know it's all completely insane; but I think that with the claim that we drafted, ...

Bernstein: Yeah, he missed the point. Okay. Well, then, the claim we drafted, this was my question. It should be right here, in this claim, in the patent he filed to date back as far as I can to protect our dates, should be changed to the claim we just created.

Becker: Oh, no, this application died on Wednesday, and it doesn't proceed to a patent. A provisional application...

Bernstein: No, no, this isn't provisional. This is a filed patent. I'm doing one.

Utley: This is the one that was filed March 24th.

Becker: Oh, okay.

Bernstein: By Ray [Joa].

Utley: So this was the PCT filing on March 24th.

Becker: Okay, thanks.

Bernstein: And my question is shouldn't the claims in this patent we just filed be exactly, if not identical, to the one...or should they be transposed to Ray [Joa's]? And it was my understanding from Doug that for speed and if the patent gets through, etc., that we would rather have it be based on that first patent filing.

Becker: That could be a recommended course of action.

Bernstein: And this is going to get dejected.

Utley: What we discussed on Tuesday...no, on Monday afternoon, was that one of our action items was to go back and review the March 24th filing and decide exactly how we were going to integrate into that filing the claims that should be in there vis-á-vis the specification.

Becker: Okay.

Utley: That was one of the action items that we covered on Monday afternoon.

Bernstein: And now my question further goes to say that once we amend the claims, is there any way to amend the body?

Becker: No.

Bernstein: Even if we're not adding new subject matter?

Becker: You can amend the body if you don't add new subject matter.

Bernstein: Okay, so we can fix Ray's mess.

Becker: You can't add what we added in this application.

Bernstein: Which part? The math is just a description of the old matter, so therefore we should be able to add it.

Becker: It's not supported. It's not suggested in the prior applications.

Bernstein: Oh, it's all suggested because by the nature of the invention it's suggested.

Becker: I think the patent office will never allow us to add all of that matter into the application.

Bernstein: Okay, but we should add as much matter as we feel comfortable with to buff up Ray's original filing.

Becker: Sometimes if you change a word or a sentence in a specification...

Bernstein: Yeah?

Becker: The examiner will outright reject it for new matter.

Bernstein: Well, who cares? He's going to reject this for insanity in the first place. I mean, he's going to reject this for "what did you patent? Nothing?"

S. Bernstein: If I'm hearing Steve right, there's very little we can do to change the language and content of that particular...

Bernstein: No, you're not hearing him right because he just said you could change all of the claims whenever you want as long as the examiner hasn't approved them. And right now before the examiner starts approving...looking at this and saying it's nonsense, I'd rather get the right stuff in there. Now, we can get most of this stuff in there, albeit I'm going to need good argumentation as to why we can't get it all in there.

S. Bernstein: Steve, is that correct?

Becker: We can change the scope of the claims of the prior application...I mean, that's a good action item, a good thing to do. You know, as I mentioned, it's unlikely we'll be able to change

the specification substantially; and if we don't quite...

Bernstein: Well, we should throw in the word "zoom" if we can.

Becker: At some point it becomes a question of language and what language you've used. If we come in and start saying, "Well, what we really were talking about is zoom and pan," Yeah, it's possible we could get some of those arguments through the examiner, but...

Bernstein: Well, we sure as shit should try.

Utley: Well, it looks like Ray took all of this out of here.

Becker: It's not as critical as getting one good filing on like we did on Wednesday.

S. Bernstein: Yeah, but the date's what's important.

Bernstein: Right.

S. Bernstein: If this March one...we have one good filing, but it's dated August 2nd. That's the difference.

Becker: But it claims priority back to...

Bernstein: The original provisional.

Becker: The original provisional, which is before this date, again to the extent that it's...

Bernstein: Right, and that's the strategy I have been hearing is the correct approach here, is that we should be cleaning up Ray's filed patent as best as we can without adding subject matter—and I don't think we really have any new subject matter other than a macro shell to re-widget our math, which is okay, we'll leave that out. But I definitely want the underlying math, because that's just not new subject matter, that's just old subject matter defined, and try to get as much of this in that examiner's hands as fast as

we can because that is our first patent and we'd like it to approve. And then you know what? Leave the macro in this one, and then you've got a reason that you've got new matter in this one that doesn't conflict with your old matter. I mean, the math, I sat through with Doug, went through this with Chris Wheeler, my father, I heard all of those things, and then I'm hearing that that's not our strategy. So I just want to be very specific on this so that we get that completed in time. I know there are issues to timing, etc., that we don't want to waste.

Now, I'm also confused of how we particularly predicted our date as well on when this was first exhibited. According to my last notes of when you guys were down here originally, we kind of went through a timeline; and that timeline has now been changed to September, when, in fact, we felt it was more like April or something as the first commercial advantage. Now Doug's talking to me about September dates, and I can list you fifty things that occur before then that will be detrimental. As a matter of fact, the first one really being something like 8/10, which only gives us six days, if my numbers are correct. We signed a license contract with [Centrec? Centrack?] to use and distribute your product. So that's well before 9/1; and these are some real critical things that depend on that date, if I'm not mistaken.

Utley: What contract?

Bernstein: [Centrec? Centrack?]. The license agreement was signed on 8/10.

Utley: The only thing we signed was a demo.

Bernstein: A demo license, yeah. Well, you were putting it up to commercialize on their site—on a public site.

Utley: But there was no charge.

Bernstein: But it's not a question of charge, according to Doug. Correct, Steve?

Becker: I need to have some facts.

Bernstein: Okay. We signed a demo to put up on a company's Web site, and we did, our materials for public viewing so that they could identify customer response.

Becker: Oh. When was this?

Bernstein: 8/10.

Becker: Okay.

Bernstein: Now, there were conversations prior to that.

Becker: Well, the upside is that we've got an application on file as of this past Wednesday.

Bernstein: Well, what about changes?

S. Bernstein: We have to deal with that one year of commercialization.

Bernstein: If we're not wrong, and I hate to preach to a lawyer, but that seems to be my understanding. So I'd like to get what is claimed in this one into Ray [Joa's] immediately, if not, somehow sooner.

Armstrong: Well, hold on, let him answer the question about commercialization. Would that be considered the first date of commercialization or a date of commercialization if there's one prior to it?

Bernstein: There's not, but...

Becker: Again, we have to start with the claimed invention...

Armstrong: This was [] imagery that we did for him.

Becker: Okay. And the inquiry is whether or not...

Bernstein: No, it's video, too, B, that we did.

Armstrong: There was video, too?

Bernstein: Sure.

Becker: The inquiry was whether or not the claimed invention was on sale more than one year before the filing date of the application.

Utley: This was a test program to determine feasibility.

Becker: That actually works in our favor. The laws recognize sort of experimental use as sort of being a mitigating factor in some types of public disclosure. Typically it's a commercialization use, or to test the commercialization of the invention, they're less likely to find it to be...

Bernstein: Well, then, that's definitely what it was.

Becker: ...commercial use.

Utley: Is there any difference, Steve, between...we signed an agreement to do that.

Becker: Okay.

Utley: There was no public visibility for another month. So which date will be the reference date?

Becker: Would you call that a sale, that agreement?

Utley: No.

Becker: Okay.

Armstrong: Were we ever paid anything by [Centrec? Centrack?]?

Bernstein: No.

Utley: No.

Armstrong: Never.

Becker: Okay, that certainly works in our favor if it wasn't an actual sale of your product. In that case, you look more at the public disclosure date.

Bernstein: Well, that was the public disclosure date.

Utlely: No, that was September.

Bernstein: No, it was this date because...well, whenever you put it up on the site publicly.

Becker: When did you put it up on the site publicly?

Utlely: It was in September. It took us awhile to get there.

Becker: Okay. No problem, then, right?

Bernstein: If that's...I'm hanging my hat on a lot of things right there.

Utlely: If that's the date of reference...

Bernstein: You know, I want to beat the 8/10 day of signing a license agreement because I don't know how that's going to be construed in court, nor do I care, when I can beat it right now.

Becker: Let me ask the question again, Eliot, do you think that the application that we filed on Wednesday does not provide enough information to enable somebody of ordinary skill in the art to practice or to make and use what we claim in claim one?

Armstrong: I could argue it doesn't.

Becker: Go ahead.

Armstrong: I might just simply because the actual deployment of it...or employment of it...does require the correct execution of those formulas; and other than one particular error that is very, very difficult to understand unless you have been part of one of these conversations about the formulas.

I mean, that you have to reverse-engineer the formulas to find out that the square root in that definition is missing, otherwise you'll end up with target image areas of an enormous size and be totally lost. You'll end up just having a goofy result. I mean, I think it could be argued, that you need to be able to apply the math to create the image. It could be argued that you can conceptually create what it is that we are conceptually defining, but it's more difficult to do that without a precise understanding of the relationship of targets of subject images and viewing windows.

Becker: Well, let me turn it against you, Jim. That's a good analysis. I think it's interesting, but let me turn it against you and say if that's true, then our August 2, 1999, filing doesn't provide enough disclosure to enable one of ordinary skill in the art to make this claim.

Bernstein: On Ray [Joa's]?

Becker: Right, what he...

Bernstein: Yeah, that's why we want to change it before August 10th.

Armstrong: You said the August 2nd filing. This is the one we just did.

Bernstein: No, the March 3rd filing you mean.

Utley: March 24th.

Bernstein: March 24th, whatever.

Becker: Well, I guess I'm going as early as I can, which is why we tried to file on Wednesday...which is why we filed on Wednesday, so we could get the priority on the provisional application which, if I recall, read very much like the March 2000 application.

S. Bernstein: The one you're referring to is the original provisional from August of 1999.

Becker: Yeah.

S. Bernstein: Saying that if my argument holds, we have nothing of solid validity in that particular document.

Becker: No, what I'm telling you is that that document won't provide priority to this claim. In other words, our priority date will be Wednesday of this year, not Wednesday of last year...or not...

S. Bernstein: Because that provisional didn't provide somebody with ordinary skill in the art the ability to replicate what we did?

Becker: That's exactly right.

Bernstein: March 24th...isn't that the one we're looking for?

Utley: March 24th?

Bernstein: Oh, no, that's the...

Utley: We're looking for the August one.

Bernstein: No, I'm looking for the provisional this claims to.

<Two separate conversations going on at once; difficult to hear and follow...>

Becker: Let me ask you this...

S. Bernstein: Then that's to say--and maybe I'll question my own logic now--is it enough to say that somebody understands that in the viewing window that you create zoom and then create [] ability?

Becker: As long as we just...

Armstrong: That optimized the particular...

S. Bernstein: And all we did was help to clarify...

Becker: I think that's pretty convincing. You know, you don't have to enable all the ways of doing it; you just have to enable essentially one way of doing it.

Bernstein: Okay. Despite all of this, I still want a firm yes or no.

Becker: I think was actually critically really finally getting to the issue.

Bernstein: No, yeah, we are.

Becker: Away from the rhetoric of accusations and...

Bernstein: Okay, okay, right, but...

Becker: And fear-mongering and calling the investors. I think we've gotten to...

Bernstein: Well, I mean, we've got to deal with things. These are real fears meaning we definitely have real issues. But looking beyond that, which is fine, I've got still an unanswered question: Does Ray [Joa's] set of claims change tomorrow, Monday, whatever, so that we can protect ourselves? Now you've agreed that's a good strategy, Doug's agreed that's a good strategy, but yet I hear no execution strategy, and that's what I want to make 100% sure that I can get as much of what we've discovered into Ray's incompetent work, and I will call it that, as possible. And your work is far more superior. These are some issues, but, you know, there's issues...it's a large thing to grasp, and we'll get through it. But I want to change what Ray [Joa's] done, and that was my understanding that we're going to take the claims that we've discovered in this application you just filed and put them into that one, and that the worst that's going to happen is that the examiner will approve the earlier one of Ray and yours will fall away, the second one.

Armstrong: Did somebody just join this call?

Bernstein: No.

Armstrong: Did you hear that beep, beep, beep?

Becker: I did. I don't know if anyone has joined.

Bernstein: Si? Si?

Armstrong: Maybe he got off.

Bernstein: Yeah.

Armstrong: Okay.

Becker: Well, let's do this, Eliot. Let's say that...I know you are concerned about the August 10th date, why don't we say that we will make some amendments to the claims in the prior filings you're referring to, and we'll clean that up as best we can and make sure that we have the claim amendments...

Bernstein: <Aside to Utley> This is the one we filed?

Utley: <To Bernstein> That's the provisional.

Bernstein: <To Utley> That's the provisional?

Utley: <To Bernstein> Right.

Armstrong: What about correcting the math in the one from two days ago?

Becker: Yeah, then again, I don't know what was filed; and again it appears...I really need to consult with Doug on that.

Armstrong: Yeah, but if we're of understanding what we talked about today is what he filed, and I believe that's it, then what do we do to correct that? We should probably correct that by the 10th as well.

Becker: Okay. Right. That actually was more important with the 8/10 date because these changes are considered to be better, then we need to get a filing out by that date.

Armstrong: Okay.

Bernstein: And Steve, just to remind you on this point, I still definitely for a comfort level and to keep accusations at bay, just a letter of what's occurred, what my risks are, and what our strategies for execution are on this filing relating to as well fixing this one as well as relating it to Ray [Joa's]. If you could write that clearly to us, that gives us a lot of comfort level.

Becker: All right. Hopefully what I explained today about priority will help.

Bernstein: Well, this gives it the final touch of you can rest assured, I've got it in writing. That's what I need to comfort me that I've got a strategy, that everybody's on the same page, so to speak, so that page doesn't shift, so that we don't get off that strategy and we all stay focused on that one sheet. So that would be critical. And what is our next due date? Is that on the 10th or the 8th or something, or am I missing...

Utley: Well, the only reason the 10th has any potential bearing is because that's when the test license...

Bernstein: I'd like to beat that here, on this claim; because if we can beat the 10th here on Ray [Joa's] filing, that's what we need to do there, right?

Becker: That's actually not an important date for Ray [Joa's] filing.

Bernstein: Yes, it is.

Becker: An important date for the filing that we did a few [weeks? days?] ago.

Bernstein: No, no, it's the same date. Commercialization is commercialization, and how it relates is the same here to us.

Becker: Okay.

Bernstein: You know what I mean?

Becker: Yeah, I guess I do.

Armstrong: I'll make just one other general comment, Steve. Everyone else knows this, but you don't. I was just brought into this process Tuesday as the first time I've ever reviewed any patents. I've held them for Eliot in the past but never reviewed them; and was probably surprised with what I found was that it was an extremely important and at least, to my understanding, we had very little time to get it right, and we're now paying the price, of course. To the extent that that can be avoided in the future through careful planning, updates, and contingencies, I suggest we have a plan for that.

Becker: Yep.

Armstrong: So. Just an overall comment.

Becker: That's a good comment. I think it's important to get things done as early as possible, and we certainly have tried to do that throughout the process.

Bernstein: Steve, can you do me one last favor?

Becker: Yes?

Bernstein: Shoot over to Jim the three video patents we filed. He's signed a disclosure on it—the one you gave us—encompassing him for all patents.

Becker: All right. Jim, what's your role?

Armstrong: I'm the Director of Sales and Marketing.

Bernstein: But he's also a shareholder.

Becker: Okay.

Armstrong: I've been with this since before anybody else.

Becker: I see.

Armstrong: It was just basically me and Eliot and Guy before anybody else started, but I've never been involved in the patent review.

Becker: Now you want me to send a copy of the filings...the video filings?

Bernstein: Yeah. Can you just fax them to him?

Becker: Sure. Let me make sure I've got this right. Okay. We've got three...no, five applications, about 100 pages. Is that fine?

Armstrong: Yes.

Bernstein: We have four. Sorry.

Armstrong: Are they emailable, or no?

Becker: Yeah, they are emailable.

Armstrong: Let's do that instead.

Becker: But then you don't have the figures. We can email....

Armstrong: Email those, and then just fax the figures?

Becker: Yeah.

Armstrong: Okay, cool. The fax number is 732-747-5569. Email is jim@iviewit.com.

Bernstein: And there's five video patents now. Correct, Steve?

Becker: I'm looking at my chart here: three US and three corresponding PCT [] applications that we wrote, and then there's a PCT video playback—that was the video playback invention—

Bernstein: Right.

Becker: And I think that's all.

Bernstein: Great. Let's get those out to Jim real quick. I'd like him reviewing those by the 8/10 date. Any changes, we're obviously going to try to revert to keep our 8/10 day as our commercialization day, giving us a little buffer if we're wrong.

Becker: All right.

Bernstein: You know what I mean? I mean because we don't know how people will interpret in the end what [Centrec? Centrack?] was, but to beat it would definitely give us a greater argument.

Becker: Yep.

Bernstein: So, all right, we'll pick this up...you're going to make those changes on this patent, correct?

Becker: I'm going to wait until I speak with Doug.

Bernstein: Okay, great.

Becker: To find out what was actually filed, and then we'll decide how best to proceed with amending that.

Armstrong: Steve, one more clarification. Did you say we have or have not had successful closure on the signing over of inventors' patents to the company?

Becker: I can't speak to that; Doug is working on that.

Armstrong: Okay, will you put that in our list of things to do...or your strategy that that gets completed?

Becker: Yeah.

Bernstein: Yeah, and B, I just signed as well as Brian and Jude and everybody. It's a large, thick document, so Doug should have an update, Steve, as to what is exactly signed. I think it was everything, correct? And we've got everybody here.

Armstrong: I've got emails that indicate that that was all done nine months ago.

Bernstein: No, it was, B, but then we filed patents; and then we thought the past was done, and now these new ones had to be done, so he came here, there was notaries here...it was, you know, it was a lot, but let's get an update on it.

Utley: In addition to that, everyone has individually signed a separate agreement with the company, assigning to the company any intellectual property that's created as a result of their employment.

Armstrong: That I know. The key inventions, I just want to see that they've signed over because that's the value of the company right there. That's what I own stock in.

Bernstein: Correct. Okay. So let's get an update, and I think we're pretty close.

Armstrong: Okay.

Becker: Eliot, why don't we go through the list of things that you've asked me to do so we can be perfectly clear on this?

Bernstein: Okay.

Becker: The first is to amend Ray's PCT application, at least the claims, so that we have a good filing there, at least based on whatever Ray has in his specification. That's task #1.

Bernstein: Claims plus any additional language that's not new matter.

Becker: All right.

Bernstein: Okay.

Becker: You want a letter describing the...what was omitted or what was incorrect in this application filed Wednesday and to what extent that may have any bearing on rights.

Bernstein: Correct.

Becker: And also a course of action we feel is necessary to file new applications to amend these, make these corrections, or if there's something we feel we can do in an amendment that would not introduce new matter.

Bernstein: And our strategy going forward on this. By the way, that would mean our strategy as well on the video, correct? Because if there needs to be changes and the date did stick at 8/10, we need to make any changes we find by 8/10, correct?

Becker: Only if the changes are so substantial that they would jeopardize the ability of one skilled in the art to understand.

Bernstein: Okay, so critical errors. Okay. If we find them.

Becker: And that's why I think, you know...and if you're describing in your specifications how to make one, how to do it, provide most of the details. I mean, we've done a very detailed job of ...

Bernstein: No, I agree. I'm not...I agree. I see all that here.

Becker: Any time whatever we can get out of you guys in terms of describing how it works...that, in there when you describe a claim and there's an error, you know, there's an error in the math, will that dramatically affect and make it so somebody can't practice the invention at all, I don't know.

Bernstein: Right. So if it's critical by 8/10, it should be resolved. Correct?

Becker: With the video application, it doesn't help for us to go back and look at those. You guys go back and look at those and see if there's anything in there that you don't like.

Bernstein: Right. And if we find something in the claim, for example, that we don't like, we need to amend it by 8/10, right?

Becker: No.

Bernstein: Why?

Becker: Because the claims have to be supported by the specification as filed back on those dates, which were sometime in June...

Bernstein: Okay, but let's say all that fits, we also have the commercialization date.

Becker: The commercialization date...

Utley: I though <inaudible comment to Bernstein>

Bernstein: So we can go change the claims.

Becker: Typically [] prosecutions, as long as they're still supported by the specifications filed...

Bernstein: Right. So if we find any mistakes, we should change them, correct? In the video patents?

Becker: Yeah, as a general principle, that's a good idea.

Bernstein: Okay, good. All right. I think that sums up what we need. Send the letter to Si, myself, and Brian.

Becker: That's not a complete list of what you asked for me to do.

Bernstein: What else have we got? Sorry?

Becker: You've asked me to email to Jim Armstrong the three video applications and the playback application—the one playback application—

Bernstein: Right.

Becker: Now with respect to the video application, we have both PCT and US filings. Do you want us to send both of those? They've essentially identical—in fact, they are identical except the...

Bernstein: No. Just one.

Utley: Send the US.

Becker: All right, we'll send the US versions of those two. And we'll fax the figures. And element #4...Item #4 is to provide a written letter to Jim Armstrong regarding the assignment status of...

Bernstein: Well, that's to everybody. That's to Brian, Si, myself, Jim.

Becker: Brian, Si, Eliot, and Jim.

Bernstein: Right. Just giving us the update of where we are.

Armstrong: I think it's helpful to communicate to the shareholders.

Bernstein: Well, let's get it first, then we'll communicate at discretion, but I think we're there.

Becker: Okay, then, in terms of general things going forward: Eliot needs to be cc:'d on all correspondence relating to patents. Should we continue our practice of sending things to Brian?

Bernstein: Yeah.

Becker: All right, we'll continue our practice of sending things to Brian and cc:ing Eliot with copies.

Bernstein: Right, and I'd appreciate if all that email comes to iviewit.com. Therefore, I have copied records.

Becker: Are you saying you only want us to correspond with you via email, not letters? Not...

Bernstein: No, but if it is emails, iviewit.com emails because that gives me complete copied records on tape backups.

Armstrong: Do don't send anything to any of us at a domain name other than iviewit.com, if you send it in email.

Becker: That's the instructions?

Bernstein: Right.

Armstrong: Correct.

Becker: Don't send to any other email address besides one of your names at iviewit.com.

Bernstein: Correct.

Becker: Okay. Anything else in addition to those items?

Bernstein: Nope. Steve, I appreciate your taking the blunt end of this, I really do.

Becker: Well, I just wish you would not...

Bernstein: Well, we freak out a little bit. You can understand that there's a reason to freak...I'm not just making this up. So based on that, let's try to resolve and move forward.

Becker: Anything else?

Bernstein: Nope. Thanks very much.



Lorraine Christine Hoffman, Esq.
Assistant Staff Counsel
The Florida Bar
File No. 2003-51, 109(15C)

Exhibit H – Rubenstein Response to the New York Bar



IVIEWIT HOLDINGS, INC.

By Facsimile

February 26, 2003

Thomas J. Cahill
Chief Counsel
First Judicial Department Departmental Disciplinary Committee
61 Broadway, 2nd Floor
New York, New York 10006

Re: General Complaint against Kenneth Rubenstein on Behalf of Iviewit Holdings, Inc. (a Delaware Corporation) ("Company")

Dear Mr. Cahill:

By way of introduction, I am President (Acting) of the above referenced Company, and write to file a General Complaint against the following member of the New York State Bar Association:

Kenneth Rubenstein
Proskauer Rose LLP
1585 Broadway
New York, NY 10036-8299
Tel.: 212.969.3185

Introduction

Kenneth Rubenstein, (hereinafter "Rubenstein"), believed to be a resident of the State of New York or New Jersey, and who at various times relevant hereto was either misrepresented to the Company as a partner of Proskauer Rose LLP (hereinafter "Proskauer") and later became a partner of Proskauer, and who provided legal services to the Company.

Moreover, beginning on or about September of 1998, the Company, through its agent and principal, Eliot I. Bernstein ("Bernstein"), began negotiations with Proskauer with regard to Proskauer providing legal services to the Company the purpose of which was to develop and market specific technologies developed by Bernstein and two others, which technologies allowed for the scaling, enlargement, panning and zooming of digital images and video without degradation to the quality of the digital image due to what is commonly referred to as "pixelation", the delivery of digital video using proprietary



scaling techniques, a combination of the image pan and zoom techniques and video scaling techniques, and the remote control of video and image applications.

Furthermore, Bernstein engaged the services of Proskauer and in turn Rubenstein, among others, through an engagement letter a true copy of which I attach herein as Exhibit "A", to obtain multiple patents and oversee US and foreign filings for such technologies including the provisional filings for the technologies as described above, and such other activities as were necessary to protect the intellectual property.

Additionally, upon information and belief, Rubenstein upon viewing the technologies developed by Bernstein, and held by the Company, realized the significance of the technologies, its various applications to communication networks for distributing video data and images and for existing digital processes, including, but not limited to digital cameras, digital video disks (DVD), digital imaging technologies for medical purposes and digital video, and that Rubenstein designed and executed, sometimes for himself or others similarly situated, deceptions, improprieties, and, even in certain circumstances, outright malfeasances by the disingenuous insertion of his own interests or the interests of third parties, who were other clients of Proskauer and Rubenstein, between the Company, as his client and together with its disclosed techniques, and the ultimate end users of its future OEM and other licensees, to the detriment and damage of the Company. Many of the malfeasances against the Company have also involved fraud against the US Patent and Trademark Office.

Secondly, while the Company was engaged in negotiations of technology agreements with including but not limited to both Warner Bros, a division of Time Warner Entertainment L.P. and its direct parent, AOL Time Warner (collectively "Warner Bros/AOLTW"), as to the possible use of the technologies of the Company, and despite the prior representations of Rubenstein, at a meeting held on or about November 1, 2000, by and between, among others, Rubenstein and representatives of Warner Bros/AOLTW as to the technologies of the Company, their efficacy, novelty and unique methodology, Rubenstein tortuously, the Company alleges, refused to subsequently make the same statements to representatives of Warner Bros/AOLTW and AOLTW, taking the position that "I have a conflict of interest in that they [Warner Brothers] are a big client of Proskauer, so I cannot comment on the technologies of Iviewit to any representatives of WarnerBros." or words to that effect in response to inquiry from Warner Bros/AOLTW's patent counsel as to the status and condition of the pending patents on the intellectual property.

Additionally, that Rubenstein, having served as an Advisor to the Board of the Company, was fully aware of the fact that the Company was in negotiations with Warner Bros/AOLTW as to the possible licensing of technologies and further funding of the operations of the Company, and further, Rubenstein as a partner of Proskauer, and despite his clear prior actions in representing the interests of the Company and having interest in stock of the Company as a partner of Proskauer (Proskauer owning two and one-half percent of the Company's founder shares) and still further as an Advisor to the Company's Board listed in all business plans, websites, etc., refused to answer questions as to the enforcement of the intellectual property of the Company with the intent and



knowledge that such refusal would lead to the cessation of the business relationship by and between the Company and Warner Bros/AOLTW and other clients familiar with the Warner Bros/AOLTW technology group and in negotiations with the Company, including, but not limited to Sony Corporation, the Viacom Inc. Paramount Pictures unit, Metro-Goldwyn-Mayer Inc., and News Corporation's Twentieth Century Fox division. Accordingly, the Company alleges, the actions of Rubenstein were and constituted an intentional and unjustified interference with the relationship by and between the Company and Warner Bros/AOLTW designed to harm such relationship and further motivated by the attempts to cover-up the conflict of interest in Proskauer's representation of both the Company and Warner Bros/AOLTW.

Finally, as a direct and proximate result of the conduct of Rubenstein, Warner Bros/AOLTW ceased business relations with the Company to the damage and detriment of the Company; the Company more specifically stipulates Rubenstein's actions and inactions directly below:

Specifics of General Complaint

Where the Company employed Rubenstein and Proskauer for purposes of representing the Company to obtain multiple patents and oversee foreign filings for such technologies including the provisional filings for the technologies as described above, and that pursuant to such employment, Rubenstein and Proskauer owed a duty to ensure that the rights and interests of the Company were protected, Rubenstein and Proskauer neglected that reasonable duty of care in the performance of legal services in that they:

- a. Failed to take reasonable steps to ensure that the intellectual property of the Company was protected; and,
- b. Failed to and/or inadequately completed work regarding patents, copyrights and trademarks; and,
- c. Failed to list proper inventors of the technologies based on improper legal advise by Proskauer, and in turn Rubenstein in his lead technological role, that foreign inventors could not be listed until their immigration status was adjusted leading to further erroneous billings by Proskauer for frivolous immigration work. This resulted in the failure of the patents to include their rightful and lawful inventors; and,
- d. Failed to ensure that the patent applications for the technologies, contained all necessary and pertinent information relevant to the technologies and as required by law; and,
- e. Failed to secure trademarks and copyrights and failed to complete trademark and copyright work for the use of proprietary names of the Company and the source codes for the technologies of the Company in relation to the intellectual property, and;
- f. Engaged in unnecessary and duplicate corporate and other work; and,
- g. By redacting information from the billing statements regarding services provided so to as to give the appearance that the services provided by Proskauer were limited in nature, when in fact they involved various aspects of intellectual property protection; and,



h. By knowingly and willfully representing and agreeing to accept representation of clients in conflict with the interests of the Company, without either consent or waiver by the Company

i. Allowed the infringement of patent rights of the Company and the intellectual property of the Company by other clients of Proskauer and Rubenstein. Failed to submit to patent pools overseen by Rubenstein Iviewit patents for inclusion to such pools, including but not limited to MPEG 2, MPEG 4, and DVD and;

j. Aided a one Raymond A. Joao, represented at first as a member of Proskauer and Rubenstein's underling, but later discovered to be an of counsel to Meltzer Lippe Goldstein & Schlissel LLP. of Mineola, N.Y. in filing patents for the Company's intellectual property by willfully withholding pertinent information and further filing patents in an untimely misrepresented manner. That Mr. Joao who was contracted to procure patents for the Company has now applied for 70+ patents in his own name, many of which appear to be ideas learned while representing the Company.

k. That due to the discovery of many of the above described events the Company's lead investor Crossbow Ventures (a referral of Proskauer Rose) of West Palm Beach, Fla., pulled funding on the Company; it is the Company's belief that this is simply another attempt by, among others, Rubenstein and Proskauer to seize the Company's assets through frivolous actions and malfeasances, when answers to the patents approval and value will be determined in a very short time.

Lastly, the negligent actions of Rubenstein and Proskauer resulted in and were the proximate cause of loss to the Company; today, the Company's processes are believed to be on digital camera's, DVD's and virtually all Internet and Broadcast streams of video; true copies of exhibits and witnesses are available on request and/or I will, on behalf of the Company, present them according to proof at commencement of investigation into this General Complaint.

Due to the highly sensitive nature of the patent and copyright materials, exhibits and witnesses will be provided once formal protections have been established in regard to this complaint.



Very truly yours,

IVIEWIT HOLDINGS, INC.

By:  : Electronic Signature
Eliot I Bernstein
561.364.4240
President

 Electronic Signature for P. Stephen Lamont by Eliot I. Bernstein his attorney -in-fact

P. Stephen Lamont
Chief Executive Officer



Exhibit "A"



PROSKAUER ROSE LLP

2255 Glades Road
Suite 340 West
Boca Raton, FL 33431-7360
Telephone 561.241.7400
Elsewhere in Florida
800.432.7746
Fax 561.241.7145

NEW YORK
LOS ANGELES
WASHINGTON
NEWARK
PARIS

Christopher C. Wheeler
Member of the Firm
Direct Dial 561.995.4702

September 8, 1999

Mr. Brian G. Utley
iviewit LLC
c/o Goldstein Lewin
1900 Corporate Boulevard, Suite 300-E
Boca Raton, FL 33431

Re: Engagement Agreement for iviewit LLC

Dear Brian:

Thank you for the opportunity to represent iviewit LLC in connection with general corporate advice (the "Work") and such other matters as we may undertake on your behalf from time to time. As is our Firm's custom, we are writing to confirm our agreement regarding such representation.

Our fees for services performed will be billed at our regular hourly rates. Currently, these rates range from \$135.00 to \$385.00 per hour for all legal services performed by the Firm's attorneys in our Boca Raton office. The hourly rate charged by any particular attorney within the range mentioned depends on such factors as that lawyer's experience, familiarity with the subject matter being worked upon, and such other factors as have been determined by the Firm in establishing the normal hourly rates for its attorneys. Time spent by any legal assistant is currently charged at \$90.00 per hour.

In addition to the fees described above, you agree to reimburse and pay us for all disbursements made by us, and our customary charges for in-house services in connection with the legal services performed under this agreement, including document reproduction and facsimile charges, computerized legal research, overtime (if required), travel expenses, court filing fees, postage, messenger and overnight courier fees, long-distance telephone charges, document preparation charges, word processing, taxes and miscellaneous expenses.

We anticipate billing you on a monthly basis, with payment of all monies due within 30 days of receipt. We will send you periodic statements setting forth the amount of the fees, disbursements and charges to which we are entitled and the basis for their calculation. Although, as noted above, we will ordinarily bill you monthly for fees, disbursements and charges of the preceding

0894/40017-001 BRLIB1/240799 v1

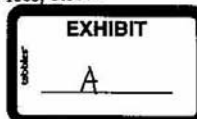

09/08/99 02:56 PM (2743)



PROSKAUER ROSE LLP

Mr. Brian G. Utley
September 8, 1999
Page 2

month, we may occasionally defer billing for a given month (or months) if the accrued fees and costs do not warrant current billing or if other circumstances would make it more convenient to defer billing.

We are waiving a retainer at this time, but we reserve the right to ask for one at any time.

You have the right to discharge us as your counsel in connection with the Work at any time, but such discharge shall not affect our right to be paid all our previously incurred but unpaid fees, and all our previously incurred but unpaid charges and disbursements, in accordance with this letter agreement.

We may from time to time, either at your request or at our own initiative, provide you with an estimate of fees or costs that we reasonably anticipate will be incurred in connection with the Work. It is understood that such estimates, which are predicated on a variety of assumptions, are subject to unforeseen circumstances and are by their nature inexact.

If you agree that the foregoing meets with your approval, please sign and return to me the enclosed copy of this letter as soon as possible.

We very much appreciate the opportunity to represent you in this matter.

Best regards.

Cordially,

Christopher C. Wheeler

0894/40017-001 BRLIB1/240799 v1

09/08/99 02:56 PM (274)

PROSKAUER ROSE LLP

1585 Broadway
New York, NY 10036-8299
Telephone 212.969.3000
Fax 212.969.2900

Steven C. Krane
Member of the Firm

Direct Dial 212.969.3435
skrane@proskauer.com

LOS ANGELES
WASHINGTON
BOCA RATON
NEWARK
PARIS

April 11, 2003

Via Hand Delivery

Thomas J. Cahill, Esq.
Chief Counsel
Departmental Disciplinary Committee
First Judicial Department
61 Broadway
New York, New York 10006

Re.: Complaint of Eliot I. Bernstein against Kenneth Rubenstein, Esq.
Docket No. 2003.0531

Dear Mr. Cahill:

This letter is in response to your March 6, 2003 letter to Kenneth Rubenstein and the accompanying complaint filed by Eliot I. Bernstein. As you would expect, both Mr. Rubenstein and Proskauer take this matter very seriously. Obviously, if you need any further information or documentation, we welcome the opportunity to assist in that regard.

Summary

Before addressing the allegations in detail, we would like to provide you with a summary of certain key points to be made below in our response:

- The Disciplinary Complaint of Mr. Bernstein must be understood in the context of a fee litigation brought by Proskauer against Mr. Bernstein's company Iviewit to collect outstanding fees of \$370,000 and the fact that Iviewit is a failed "dot.com" company looking for someone to blame for its failure.
- For Mr. Bernstein's allegations to be true, Mr. Rubenstein and Proskauer would have had to act totally against their own economic interests. Proskauer owns 2.5% of Iviewit. Why would Proskauer engage in an alleged conspiracy to cause Iviewit \$10 billion in damages, and thereby cause Proskauer itself to lose \$250 million? This is an amount

more than twenty times larger than the cumulative amount paid to Proskauer by its largest client in the 2002 fiscal year.

- Iviewit's own conduct shows that it does not really believe the allegations in the complaint. While Iviewit's CEO, Mr. Bernstein, is alleging that in the years 2000 and 2001 Mr. Rubenstein participated in a conspiracy to steal Iviewit's technology, on November 20, 2002, Iviewit presented Mr. Rubenstein with a letter requesting that he perform legal work for Iviewit. The Committee should consider how a party could almost simultaneously make serious allegations with respect to the conduct of an attorney and also request (or more accurately, pressure) the very same attorney to represent it.
- Mr. Bernstein has presented no evidence whatsoever to support the allegations in the complaint. In contrast, the deposition and documentary evidence presented below, show that the accusations are without merit. The evidence shows Mr. Rubenstein performed no patent work for Iviewit and engaged in no activities whatsoever that were adverse to Iviewit.
- Excerpts of Mr. Bernstein's deposition taken in the aforementioned litigation show that he lacks credibility with respect to the allegations in the complaint.

Background

The complaint relates to an attorney-client relationship between Proskauer (primarily its Boca Raton, Florida office) and several corporations bearing the name "Iviewit," of which Mr. Bernstein was a principal. Christopher Wheeler, a partner resident in Proskauer's Boca Raton office, was primarily responsible for representing Iviewit as general corporate counsel from approximately December 1998 through May 2001, when Proskauer withdrew from its representation due to Iviewit's nonpayment of Proskauer's legal bills. During this two and a half year relationship, approximately twenty Proskauer attorneys in its Florida and New York offices performed a vast array of corporate, securities, restructuring, and refinancing work for the Iviewit entities. However, as will be shown below, neither Proskauer nor Mr. Rubenstein performed any patent work for Iviewit.

Iviewit fell victim to the same plague that affected many "dot.com" companies during this time period -- a lack of funding. As a result, Iviewit suffered financial problems, and amounts owed to Proskauer continued to grow. Ultimately, Iviewit owed Proskauer a total of almost \$370,000 for legal services by the time Proskauer ceased to represent it. When Iviewit was unable to arrive at a satisfactory payment arrangement, Proskauer filed a lawsuit in May 2001 in Palm Beach County, Florida Circuit Court (the "Litigation") seeking to collect its attorneys' fees. The action is entitled *Proskauer Rose LLP v. Iviewit.com, Inc. et al.*, Case No. CA 01-04671 AB (the

“Litigation”), and is currently set for trial in West Palm Beach, Florida on May 28-29, 2003. A copy of the Amended Complaint filed in the Litigation is attached hereto as **Exhibit 1**.

On January 28, 2003, after the Litigation had been pending for over 21 months, Iviewit sought leave to assert what it contended was a **\$10 billion** counterclaim, raising allegations similar to those contained in Mr. Bernstein’s complaint against Mr. Rubenstein. A copy of the proposed counterclaim is attached hereto as **Exhibit 2**. The Court denied Iviewit’s motion for leave to amend by order dated February 4, 2003, a copy of which is attached as **Exhibit 3**. Mr. Bernstein’s complaint against Mr. Rubenstein followed on the heels of that denial.¹

On January 31, 2003, Mr. Bernstein’s deposition was taken in the Litigation. At that time, Mr. Bernstein offered sworn testimony of what he described as a conspiracy, occurring in 2000 and 2001, to steal his technology. According to Mr. Bernstein, the conspiracy was set in motion by Mr. Wheeler, along with such alleged co-conspirators as Mr. Rubenstein, Iviewit’s former President (Brian Utley), special counsel at the nationally known law firm of Foley & Lardner (William Dick), and another lawyer previously employed by the law firm Meltzer, Lippe, Goldstein & Schlissel, LLP (Raymond Joao).² According to Mr. Bernstein’s sworn testimony, this plot involves an alleged death threat made by Iviewit’s former President and Chief Operating Officer, which, as Mr. Bernstein testified, has caused him to fear for his life and, as we will show below, has caused Mr. Bernstein to believe that Proskauer is “evil.”

Obviously, there was no murder plot, no conspiracy, and no attempt on the part of anyone to injure Mr. Bernstein or his business. We point this out only to highlight the rather extreme and unfounded nature of the accusations leveled against a whole host of attorneys, at several law firms throughout the United States. We respectfully suggest that, viewed in context, Mr. Bernstein’s submission to the Committee is simply an ill-advised litigation tactic that is devoid of any factual or legal support. Unfortunately, Mr. Rubenstein is simply one of several attorneys caught in the crossfire of a fee dispute. Regardless of Mr. Bernstein’s motives, his accusations are squarely negated by the record.

Despite Mr. Bernstein’s allegations of malpractice and “malfeasance,” as recently as November of this past year (well after the alleged malfeasance and malpractice was alleged to occur), Iviewit sought to enlist Mr. Rubenstein’s assistance:

¹ Contemporaneously with the filing of the complaint against Mr. Rubenstein, Mr. Bernstein also filed a similar complaint against Mr. Wheeler with the Florida Bar. Mr. Wheeler’s response was filed on April 7, 2002 and the matter is currently pending.

² We understand that Mr. Bernstein also filed a similar complaint with the Departmental Disciplinary Committee against Mr. Joao.

“to review the conclusions of past and present patent counsel, and to further assist Iviewit in further defining the inventions in any intellectual property arena of [Iviewit’s] choosing”

A copy of Iviewit’s November 20, 2002 correspondence to Mr. Rubenstein is attached as **Exhibit 4**. For obvious reasons, most notably the pendency of the Litigation, Mr. Rubenstein declined this request. Prior to that, but subsequent to the termination of Proskauer’s representation of Iviewit and filing of the aforementioned lawsuit, Iviewit had sought to capitalize on the existence of an attorney-client relationship between Mr. Rubenstein and Warner Bros. by essentially asking Mr. Rubenstein to vouch for Iviewit’s technology to a client contact at Warner Bros. Mr. Rubenstein refused this request, citing conflict of interest issues. This conduct of Iviewit shows that Mr. Bernstein and Iviewit are not serious about their own allegations.

As an aside, Mr. Bernstein also notes in his complaint to this Committee the fact that he gave a gift to Proskauer of a small percentage of stock in Iviewit. Mr. Wheeler testified in his deposition in the Litigation that Mr. Bernstein wanted to grant shares of Iviewit stock to Proskauer because Mr. Bernstein felt that “all members of his team should be stakeholders in his company.” (Wheeler dep. At 62-24). Mr. Utley also testified that it was Mr. Bernstein’s “personal decision” (Utley dep. At 241-9) to grant a small interest in Iviewit, LLC (a corporation that is no longer in business) to Proskauer “because of the quality of work that [Proskauer] had performed for the company over the prior six months.” Id. at 238-19. Clearly, there is no ethical prohibition to Proskauer accepting this gift of stock from Mr. Bernstein. But even more to the point, the fact that this gift was made at all provides compelling evidence to refute Mr. Bernstein’s conspiracy theories. If Proskauer owned 2.5 percent of Iviewit, LLC, why would, as Mr. Bernstein alleges, Proskauer engage in a conspiracy to cause \$10 billion in damages to Iviewit? Such conduct would be directly adverse to Proskauer’s economic interest by causing Proskauer to lose \$250 million. Simply put, Mr. Bernstein’s allegations make no sense.

I. The Issues Raised in Mr. Bernstein’s Complaint

As far as we can discern from Mr. Bernstein’s submission to the Committee, he appears to raise two main issues. They are summarized below, and our response is noted.

A. Patent Work: Most of Mr. Bernstein’s allegations derive from his claim that Mr. Rubenstein mishandled certain patent work. To the contrary, as we show below (see Section II), there is overwhelming testimonial and documentary evidence showing that this allegation is false. Approximately twenty Proskauer attorneys performed legal services for and billed time to Iviewit matters. Mr. Rubenstein wasn’t one of them. Of the almost \$370,000 owed by Iviewit for legal services rendered by Proskauer, Mr. Rubenstein did not bill a minute of time to the engagement. Further, even ignoring Mr. Rubenstein’s lack of involvement, no one else at

Proskauer performed patent work for Iviewit. Iviewit's patent work was handled entirely by patent attorneys at other law firms. Whether there were any errors or omissions with the patent work is immaterial. Proskauer simply did not perform that work.

B. Conflicts of Interest: Mr. Bernstein alleges that Mr. Rubenstein, through "deceptions, improprieties . . . , and outright malfeasances" : (i) represented other clients with a conflict of interest to Iviewit; (ii) allowed the infringement by other clients of Iviewit's "intellectual property rights"; (iii) tortiously interfered in Iviewit's relationship with Warner Bros.; and (iv) personally benefited, along with Proskauer clients, to the detriment of Iviewit. The reality is that Mr. Rubenstein engaged in no activities whatsoever that were adverse to Iviewit, there was no tortious interference, no personal profiting at the expense of Iviewit and, to Proskauer's knowledge, no other parties have infringed upon Iviewit's "intellectual property rights." (see Section III, below)³.

II. Neither Mr. Rubenstein Nor Proskauer Performed Patent Work for Iviewit

Mr. Bernstein's complaint is replete with allegations concerning alleged improper or mishandled patent work somehow overseen or performed by Mr. Rubenstein. But Mr. Bernstein cannot point to a single document relating to patent work which is signed by Mr. Rubenstein or any other patent attorney at Proskauer. The work performed by Proskauer is reflected in billing statements submitted to Iviewit on a monthly basis. Copies of these billing statements are attached hereto as **Exhibit 5**. Proskauer attorneys who performed legal services for Iviewit would record their time, and the bills submitted by Proskauer represent a compilation of those time entries. Importantly, in all of the bills submitted to Iviewit, there is not a single time entry for Mr. Rubenstein. The reason for this is simple : he did not provide legal services on behalf of Iviewit. Apparently realizing the significance of this fact, Mr. Bernstein claims without any factual basis that Proskauer improperly altered its billing statements. There is simply no truth to this unsupported accusation, which we find very troubling. The billing statements are attached to this response. Should you have any question whatsoever as to whether the bills are genuine, our billing file is available for your review.

In addition to Proskauer's billing statements, which are devoid of any time entries by Mr. Rubenstein, both Proskauer attorneys and corporate representatives of Iviewit have confirmed under oath that neither Mr. Rubenstein nor Proskauer performed any patent work for Iviewit.

In short, the deposition testimony in the Litigation and the documentary evidence unequivocally establish that Mr. Rubenstein did not perform any patent work for Iviewit. To the contrary, all of Iviewit's patent work was performed by Raymond Joao, who at the time was employed by Meltzer Lippe, and thereafter by William Dick of Foley & Lardner. This is confirmed by the

³ We note that Iviewit has not been able to secure any patents on its technology, so we are not even aware of what "intellectual property rights" Mr. Bernstein is referring to.

depositions taken during the course of the Litigation, including that of Iviewit's former President and COO, Brian Utley, who testified that "Rubenstein and Mr. Wheeler, I'll repeat, had nothing to do with the patents" (Deposition of Brian Utley ("Utley dep.") at 150-9) and "I'm not aware – other than referring Iviewit to Meltzer, Rubenstein never did any work for Iviewit." (*Id.* at 121-3). Moreover, Mr. Utley testified numerous times that Mr. Rubenstein, who is a patent attorney, simply recommended Mr. Joao's firm to Iviewit when asked for a recommendation for outside patent counsel. *Id.* at 70-4; 121-3. Mr. Utley also testified that he has never met Mr. Rubenstein. *Id.* at 121-20. Mr. Wheeler also verified that that Mr. Joao was Iviewit's patent counsel (Deposition of Christopher Wheeler ("Wheeler dep.") at 23-20) and that Mr. Rubenstein did not do any patent work for Iviewit (*Id.* at 24-11).

When asked to opine as to the veracity of an interrogatory answer submitted by Mr. Bernstein during the course of the Litigation which suggested that Proskauer played a role with respect to Iviewit's patent work, Mr. Utley was unequivocal in his response:

Q. The answer to [Eliot Bernstein's] Interrogatory 20 in Subparagraph Roman Numeral XI, 11, it says: "Chris Wheeler agreed to investigate charges that Rubenstein and the name J-O-A-O, which I think is Joao. . . . [w]ere forging and changing patent documents and leaving inventors off patents. Wheeler and Utley suggest using their friend William D-I-C-K, and then it looks like it's cut off, Foley & Lardner to correct the gross negligence uncovered in Rubenstein/Joao work."

How do you respond to that statement?

A. Well, Rubenstein was never involved in any of that work.

Q. Is that a misrepresentation?

A. That's a misrepresentation.

Q. Were there any charges by you or anyone at Iviewit that Joao was forging and changing patent documents and leaving inventors off patents?

A. No.

Utley dep. at 83-15.

Gerald Lewin, a certified public accountant and principal of the CPA firm of Goldstein, Lewin & Company in Boca Raton testified similarly. He testified that he was initially approached by Eliot Bernstein's father, Simon Bernstein, who is also Mr. Lewin's neighbor, and asked to be a consultant for the Iviewit entities. (Deposition of Gerald Lewin ("Lewin dep.") at 7-14). Mr. Lewin agreed and ultimately became a member of Iviewit's board of directors. *Id.* at 9-1. Mr. Lewin introduced Eliot and Simon Bernstein to Mr. Wheeler at Proskauer's Boca Raton office, after the Bernstein's asked Mr. Lewin for a referral to a national law firm to represent the Iviewit entities. *Id.* at 8-3. Like Messrs. Utley and Wheeler, Mr. Lewin testified that Proskauer did not perform patent work for Iviewit and that the patent work was handled by other law firms. *Id.* at 10-25; 17-16; 50-8. Further, Mr. Lewin confirmed that Mr. Rubenstein's only involvement with

Iviewit was to provide a referral to an outside law firm to handle Iviewit's patent work. *Id.* at 17-16.

Mr. Rubenstein, who was also deposed in connection with the Litigation, could not have been clearer as to the scope of Proskauer's representation:

- Q. Did you ever opine with regard to the validity of any patent applied for or received by Iviewit.com?
- A. Like I say, I was not in any way involved with getting patents for Iviewit.
- Q. What were you involved with, if you were, with Iviewit?
- A. The only thing I did for Iviewit is I referred them to another patent lawyer.
- Q. And who is that?
- A. A guy named Ray Joao.
- Q. And where did Mr. Joao work?
- A. I believe he was working at the time at my former law firm, Meltzer Lippe.

(Deposition of Kenneth Rubenstein ("Rubenstein dep.") at 23-4).

Finally, Raymond T. Hersh, Iviewit's former Chief Financial Officer, also confirmed in his deposition that Proskauer did not perform any patent work for Iviewit, and stated that Iviewit "always had separate patent counsel." (Deposition of Raymond Hersh ("Hersh dep.") at 12-25).

Thus, regardless of whether Mr. Bernstein is pleased or displeased with the patent-related services provided to Iviewit, Proskauer simply did not provide those services. Moreover, Mr. Bernstein's accusations relating to Mr. Rubenstein's involvement in Proskauer's representation of Iviewit are demonstrably baseless. Every fact witness other than Mr. Bernstein has confirmed Mr. Rubenstein's testimony that he was not actively involved in Proskauer's representation of Iviewit.

III. Mr. Rubenstein Did Not Engage in Any Conduct Adverse to Iviewit

Mr. Bernstein's complaint makes accusations that Mr. Rubenstein represented clients in conflict with Iviewit and failed to disclose such representations and/or secure conflict waivers from Iviewit. These accusations are factually unsupportable.

Although Mr. Bernstein alludes to some alleged conflict involving Warner Bros., there is no merit to any such claim. While it is true that Proskauer provides legal services to Warner Bros. in various contexts, none of them involve taking a position adverse to Iviewit and, in fact, none of them even related to Iviewit at all. Aside from a brief review of a draft confidentiality

agreement with Warner Bros. by a lawyer in our Boca Raton, Florida office,⁴ Proskauer performed no work for Iviewit that is in any way related to its dealings with Warner Bros. More to the point, Mr. Rubenstein's only involvement with Iviewit concerning Warner Bros. was at the urging of Mr. Utley, who suggested that Mr. Rubenstein call his contact at Warner Bros., Gregory Thagard, to simply suggest that Warner Bros. talk to Iviewit. At a later date, subsequent to the termination of Proskauer's representation of Iviewit and after the filing of the lawsuit, Stephen Lamont, an Iviewit representative sought to enlist Mr. Rubenstein's assistance by having him tout Iviewit's product to Warner Bros. Mr. Rubenstein declined this request, specifically citing Proskauer's existing relationship with Warner Bros.

In short, when asked by Iviewit to do so, Mr. Rubenstein refused to place himself in a potential conflict of interest situation. And while Mr. Bernstein labels Mr. Rubenstein's refusal as tortious, the reality is that his decision was strictly guided by ethical considerations and entirely justified under the circumstances. Certainly it cannot be said that Mr. Rubenstein had any obligation to tout Iviewit's product months after Proskauer ceased representing Iviewit and after the filing of the Litigation.

As for Mr. Bernstein's claim that Iviewit has suffered damages as a result of Mr. Rubenstein's refusal, the record in this matter clearly establishes that Iviewit had an independent relationship with Warner Bros. that continued on even after Proskauer's involvement with Iviewit ended. In fact, Iviewit's "Business Plan," attached hereto as **Exhibit 6**, reveals that Iviewit maintained an independent relationship with Warner Bros. well after Proskauer's representation of Iviewit ended. The Business Plan lists, at pages 35-36, "Gregory B. Thagard - Former Vice President, Advanced Technology Technical Operations, Warner Bros." and "David J. Colter - Vice President of Technology and Standards, Warner Bros." as members of Iviewit's advisory board. The Business Plan further details, at page 20, a relationship with Warner Bros. beginning in 2000 and lasting through November 2001 - six months after Proskauer ceased representing Iviewit.

Iviewit's independent relationship with Warner Bros. is further demonstrated by an email shown to Mr. Rubenstein during his deposition in the Litigation. The email, dated August 1, 2001 -- three months after Proskauer ceased representing Iviewit -- was sent by David Colter of Warner Bros. to Crossbow Ventures, and explains that Iviewit is "currently finalizing a contract with WB Online. . . ." A copy of the email is attached as **Exhibit 7**. The email not only refutes Mr. Bernstein's claim that Mr. Rubenstein somehow interfered with Iviewit's relationship with Warner Bros., it negates Mr. Bernstein's claim that Mr. Rubenstein or Proskauer somehow caused Crossbow Ventures to cease funding Iviewit, as the email shows a relationship between Iviewit and Crossbow Ventures well after Proskauer stopped performing work for Iviewit.⁵

⁴ The attorney in Boca Raton was unaware that there were attorneys in the New York office who performed legal services for Warner Bros.

⁵ We note that the email provides a characterization of Iviewit's patents attributed to Mr. Rubenstein. We would like to note that this attribution is hearsay of hearsay, as Mr. Rubenstein has never spoken to the writer of the email.

Mr. Bernstein's complaint also alleges that Mr. Rubenstein served as a member of Iviewit's advisory board. Although the relevance of this claim is unclear, there is no truth to it. Iviewit apparently listed Mr. Rubenstein as an advisory board member on its website without Mr. Rubenstein's permission. Indeed, Mr. Utley confirmed at his deposition that Mr. Rubenstein was not on Iviewit's advisory board:

- Q. Okay. So Rubenstein's sole role, from what you understand, is he referred Iviewit to the Meltzer Lippe Law Firm in New York?
- A. Yes.
- Q. Was he ever part of an advisory board or was he an advisory board member to Iviewit? And we're talking about Mr. Rubenstein.
- A. I have never used him as an advisory board member.
- Q. Are you aware of whether or not he ever attended any board meetings with the directors of Iviewit?
- A. He never attended a board meeting. I've never met the man.

Utley dep. 121-6. In fact, Mr. Wheeler had discovered that both he and Mr. Rubenstein had been listed, without their permission, as advisory board members on Iviewit's website. Mr. Wheeler asked Iviewit to remove their names from the website in the Spring of 2001.

Finally, as for Mr. Bernstein's unspecific claim that Mr. Rubenstein somehow inserted his own interests or the interest of third parties ahead of Iviewit, such allegation is absurd. The overwhelming testimony of third parties and documentary evidence shows that, other than placing a gratuitous call to his contact at Warner Bros. and recommending Mr. Joao as outside patent counsel, Mr. Rubenstein had nothing to do with Iviewit. In the event the allegations are related to Iviewit's patent applications, we would like to point out to the committee that WIPO (World Intellectual Property Organization) has published Iviewit's PCT patent applications in its database. Please go to <http://ipdl.wipo.int/>. Copies of the cover pages of Iviewit's published applications as obtained from the aforementioned WIPO website are attached hereto as **Exhibit 8**. We note that these patent applications list Foley & Lardner as Iviewit's patent attorneys.

IV. Mr. Bernstein's Accusations Must Be Considered In Light Of His Recent Deposition Testimony

Mr. Bernstein's deposition testimony in the Litigation, taken just over a month ago, provides important context for consideration of his charges against Mr. Rubenstein. Almost irrespective

We would also like to note that the characterization is not one that Mr. Rubenstein could have provided. First of all, Iviewit has no patents (only patent applications). Second of all, Mr. Rubenstein never did any legal work which could form the basis of an opinion with respect to Iviewit's patent application.

of the topic of questioning being pursued, Mr. Bernstein's testimony drifted into tales of murder, conspiracy, and theft involving several lawyers of national law firms and well respected businessmen and philanthropists:

* * *

A. . . . Well, my attorney Caroline has been working with people to protect me. Utley came out after being terminated, and they found patents had been written into his own name going to his house without assignment to the company, et cetera.

And [Brian Utley] came out and basically told me that my life was in danger if I continued to pursue to be vocal about the fact that, you know, his background was clouded and that these patents were found -- well, that malfeasances were occurring is how I could basically couch that. And he said that him and Chris [Wheeler] would bring the company down brick by brick.

Q. Utley said this?

A. Yes.

Q. When was this?

A. This was around the end of 2000, in the January period.

Q. So you started learning about a conspiracy around that time?

A. Well, you know, the real -- you know, again, you ask about conspiracies. And you know, with hindsight, I could basically call it a conspiracy. But the real first conspiracies I learned of -- if you're asking for the whole conspiracy, is Ray Joao's work.

(Deposition of Eliot Bernstein ("Bernstein dep.") at 47-11).

As seen below, the alleged conspirators are numerous:

Q. You have no idea why Mr. [Hank] Powell was fired from Crossbow?

A. Perhaps for being involved in this conspiracy to steal my technologies.

Q. Mr. Powell was involved in the conspiracy?

A. I am not sure if Crossbow is involved, although they were referred to us by Chris Wheeler who spearheads the conspiracy. But, you know, you don't find these things out when there's a conspiracy until after the conspiracy is over.

Id. at 59-17.

Q. -- was [Maurice] Buchsbaum involved in the conspiracy?

A. Buchsbaum is related to Chris Wheeler, so we're not sure yet 100 percent.

Id. at 60-10.

Q. What did [Utley] tell you when he threatened your life?

A. He said: If you continue to expose these issues and pursue a course against me and Proskauer, we will kill you.

Q. Who is "we"?

A. Mean him, Chris Wheeler and Mike --

Q. Are you paraphrasing or are you quoting him?

A. I'm quoting him. And we will bring you down brick by brick by brick, your companies.

Q. He said: We will kill you --

A. Yes.

Q. -- and we will bring you down brick by brick?

A. Correct. So I called my wife and moved her into a hotel in California. She packed up overnight to move our children into a hotel. And we so lived in a hotel until we could get adequately --

Q. When was this?

A. We told everybody this.

Q. When was this?

A. This is right around January of 2001.

Id. at 93-14.

Q. Did Mr. Utley threaten you in person or over the phone?

A. In person.

Q. Do you feel that he had the means to kill you?

A. Well, he was touting Mr. Wheeler and Proskauer as being uncovered at this point for some of these malfeasances, like his background education. Yeah.

Q. Do you feel that he had the means to kill you, is the question.

A. Yes. With those he was saying he's conspiring with absolutely.

Q. Who was he conspiring with to kill you?

A. Mr. Wheeler, Mr. Bill Dick of Foley & Lardner. These are some major law firms.

Q. So you felt at the time that if Mr. Utley was going to kill you, he was going to do it in conspiracy with Foley & Lardner and Proskauer Rose?

A. With members of those firms that he's good friends with.

* * *

Q. What other law firms were conspiring with Wheeler, Utley, and Proskauer?

A. Meltzer, Schnitzel & Gold (ph)--

Q. Meltzer Lippe --

A. Meltzer Lippe Schnitzel & -- I think Goldstein or something.

Id. at 98-10.

Q. Have you feared for your life because of this lawsuit?

A. You bet, every single day. I've hidden my children off the streets. I'm scared to death to leave my house. My wife is scared to death to leave the house.

* * *

Q. Do you think Proskauer Rose wants you dead?

A. Yes.

Q. Why?

A. Well, the technologies are valued to be worth billions; that, in itself, is a motive.

* * *

Q. Why did you come here today if you are afraid for your life?

A. I fear no evil.

* * *

Q. --in your mind you agreed to come here for your deposition today if this firm wants you dead.

A. I fear no evil. I fear no evil.

Q. Is Proskauer evil?

A. Yes. Because of these actions, yes.

Id. at 107-24.

Q. Why do you come [to Proskauer's offices] and -- you have been here about three days now to review the files.

A. Yeah.

Q. Why do you come here and spend the day here when you fear for your life?

Why don't you just have Kinko's come and pick the files up and copy them for you?

A. I fear no evil, A, okay; I expressed that on the record before.

* * *

You know, if I died tomorrow from a hiccup, perhaps, everybody would look back here.

Q. At Proskauer?

A. Absolutely.

Q. And think that --

A. Chris Wheeler.

Q. -- that they orchestrated an accidental death?

A. Correct. Or something, or purposely done.

Id. at 125-14.

Q. Do you think your lawyer fears for his life?

A. I asked him that the other day.

Q. What did he say?

A. He said he fears nobody. He doesn't care that you are big. He doesn't care how big you are, he is not afraid of you.

Q. Do you think he is?

A. Yeah.

Q. You think he's in fear for his life because of this lawsuit?

A. Yes. I think it has run across his mind that he is sitting on a can of worms that could lead to the destruction of three large law firms.

Id. at 117-1.

Q. Why did you move back to close proximity of Proskauer Rose, if you are in fear for your life of Proskauer?

A. I study the art of war, so deception and distance are often key tactics to warfare.

Somebody made a threat on me in their home ground, so I left their home ground to a ground where I have many legal friends. People to help me protect myself.

Q. Here?

A. No, California. I don't know shit here.

So -- and that's why I'm scared here. And I was scared for collateral damage to people like my parents, and whatnot, so I broke ties with them,

hardly talked to them over the last year and a half, didn't let them see their grandchildren, never flew back here, okay.

Now I am prepared to wage war and have my evidence and guns in lie, I have no fear of --

Q. When you say "guns," are you speaking metaphorically?

A. Yes, of course.

Q. Okay.

A. And so, it's best to be here so that I can present my case, and I am not worried about you anymore killing me too much.

Q. Proskauer?

A. Proskauer, because now I think you've realized that there's a lot of people behind it that you didn't see coming, or you weren't paying attention and suddenly you've got a case.

Id. at 118-19.

As can be seen, the "truth" regarding the Litigation and the claims asserted by Mr. Bernstein's complaint against Mr. Rubenstein proved to be a fluid concept in his deposition. As the deposition demonstrates, a person is either supporting Mr. Bernstein fully and unconditionally or is part of a conspiracy to destroy him. Mr. Bernstein's response to questions concerning Mr. Lewin and his possible involvement in a conspiracy is telling in this regard:

Q. Was [Gerald] Lewin part of the conspiracy?

A. Gerri just referred me to Chris [Wheeler].

* * *

Q. [w]ere you on the telephone during Gerri Lewin's deposition?

A. No.

Q. He testified in his deposition that the only reason the bills weren't paid was because there wasn't any money?

A. **Well, then, we might have a problem with him being involved in the conspiracy.**

Id. at 186-25.

Mr. Bernstein's deposition testimony concerning his claim of "destruction" of documents is equally telling. Without a shred of evidence, Mr. Bernstein was willing to swear to the "destruction" of documents simply because he had not seen them:

Q. Did you ever see with your eyes anyone at Proskauer destroying any documents pertaining to Iviewit?

A. No.

Q. Did anyone ever tell you that they saw anyone at Proskauer destroying documents relating to Iviewit?

A. No.

Id. at 169-13.

Q. So you are still sticking to your story that Proskauer destroyed documents --

A. In my interpretation --

Q. -- but you have no personal knowledge of whether they did?

A. -- of the word destruction, because they are not present in any records that the company can now get, yes, they have been, since Mr. Wheeler was keeping records of them.

Q. So destroyed means missing to you?

A. Yes.

Id. at 238-6.

VIII. Conclusion

In order to assist you in your review of this matter, we have endeavored to provide you with specific references to deposition testimony and documents which refute Mr. Bernstein's assertions. In the process, we hope we have answered any questions you may have concerning Proskauer's representation of Iviewit and Mr. Rubenstein's lack of involvement in that representation. Mr. Bernstein's accusations are simply unfounded and in many respects scandalous. As can be seen, Iviewit's own officers and directors have given sworn testimony refuting each and every assertion made by Mr. Bernstein. Our files are open and available for your review should you have any questions concerning this matter or need any additional information or documentation.

Thomas J. Cahill, Esq.
April 11, 2003
Page 16

We thank you for giving us the opportunity to be heard.

Very truly yours,

A handwritten signature in black ink, appearing to read 'S. C. Krane', with a long horizontal flourish extending to the right.

Steven C. Krane

Encl.



Lorraine Christine Hoffman, Esq.
Assistant Staff Counsel
The Florida Bar
File No. 2003-51, 109(15C)

Exhibit I – Goldstein Lewin - Conflict of Interest Letters



Lorraine Christine Hoffman, Esq.
Assistant Staff Counsel
The Florida Bar
File No. 2003-51, 109(15C)



GOLDSTEIN LEWIN & CO.
Certified Public Accountants

June 24, 1999

Chris Wheeler
Proskauer Rose LLP
2255 Glades Road, Suite 340W
Boca Raton, FL 33431

Dear Chris:

Enclosed are the remaining executive employee affidavits for Goldstein Lewin & Co. regarding the iViewit, Inc. conflict of interest matter. At this time, all employees have submitted an affidavit.

Thank you for your assistance.

Sincerely,

GOLDSTEIN LEWIN & CO.
Certified Public Accountants

Gerald R. Lewin, CPA

GRL/bjw
Enclosures (11)

c: Eliot Bernstein

f:\data\99\40875\fin\affids.doc.

1900 N.W. Corporate Blvd.
East Building Suite 300
Boca Raton, Florida 33431
(561) 994-5050

Broward (954) 429-8555
Dade (305) 944-3582
Palm Beach (561) 737-0309
FAX (561) 241-0071

Fort Lauderdale Office
4850 West Prospect Road
Fort Lauderdale, FL 33309
(Reply to Boca Address)



Lorraine Christine Hoffman, Esq.
 Assistant Staff Counsel
 The Florida Bar
 File No. 2003-51, 109(15C)



GOLDSTEIN LEWIN & CO.

Certified Public Accountants

AFFIDAVIT

To: Simon Bernstein
 Eliot Bernstein
 Board of Directors
 IVIEWIT, Inc.
 500 S.E. Mizner Boulevard, Suite 102
 Boca Raton, FL 33432

Re: Possible Conflict of Interest
 Visual Data Corporation
 Hotelview Corporation

I, Diedre Purvis, am presently employed by the firm of Goldstein Lewin & Co., Certified Public Accountants. At no time whatsoever have I discussed, nor intend to discuss, any information regarding IVIEWIT, Inc. with any members of the Board of Directors, officers or employees of Visual Data Corporation or Hotelview Corporation. I have never owned, nor do I currently own, stock of Visual Data or Hotelview. I have never advised any members of my family or anyone else to buy or sell stock of Visual Data or Hotelview.

I have never been, nor am I currently, a member of the Board of Directors or any advisory committee of Visual Data or Hotelview.

Diedre Purvis
 Signature
June 17, 1999
 Date

STATE OF FLORIDA
 COUNTY OF PALM BEACH

Sworn and subscribed before me this 17th day of June, 1999, by
Diedre Purvis who is personally known or who has produced
 _____ As identification.

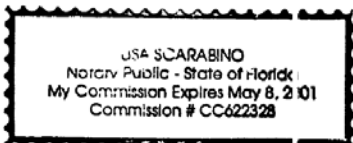

Lisa Scarabino
 Signature of Notary Public
LISA Scarabino
 Printed Name of Notary Public
 State of Florida at Large
 My Commission No.
 My Commission Expires:



Lorraine Christine Hoffman, Esq.
 Assistant Staff Counsel
 The Florida Bar
 File No. 2003-51, 109(15C)



GOLDSTEIN LEWIN & Co.
 Certified Public Accountants

June 7, 1999

Simon Bernstein
 Eliot Bernstein
 Board of Directors
 IVIEWIT, Inc.
 500 S.E. Mizner Boulevard, Suite 102
 Boca Raton, FL 33432

Re: Possible Conflict of Interest
 Visual Data Corporation
 Hotelview Corporation

Dear Simon and Eliot:

Based on the billing records I have reviewed, our engagement for Visual Data Corporation and its subsidiary, Hotelview Corporation started in October of 1994. I had originally obtained the client and turned it over to the firm's auditing department which has since then managed all engagements and kept contact with the clients.

We prepared certified audits for the above mentioned clients for years ended September 30, 1994, September 30, 1995 and September 30, 1996. Our firm assisted Visual Data and its subsidiary, Hotelview, in becoming a publicly traded corporation while we were preparing the September 30, 1996 audit. Subsequently, the underwriter felt that a national firm would best serve the client with their auditing services and the auditing function was turned over to Arthur Andersen which performed the September 30, 1997 and September 30, 1998 audits. Our firm continued to prepare a consolidated tax return for Visual Data and Hotelview.

It was my personal understanding from the beginning of the engagement that Visual Data was a holding company and Hotelview was a subsidiary operating corporation. When I met with the two of you some months ago, I pointed out that Hotelview was a client of our firm, but that we were no longer engaged to prepare their audit. The only discussion I recall between us related to the quality of Hotelview's pictures. It was approximately a week ago when Eliot discussed business activity of Visual Data that I even realized that it conducted its own business and was not merely a holding company.

After turning over the account to the auditing department in October of 1994, I had no involvement with the client, the auditing function or the preparation of the tax returns. At no time whatsoever have I discussed any information regarding IVIEWIT, Inc. with any members of the Board of Directors, officers or employees of Visual Data Corporation or Hotelview Corporation. I have never owned, nor do I currently own, stock of Visual Data or Hotelview. I have never advised any members of my family or anyone else to buy or sell stock of Visual Data or Hotelview.

I have never been, nor am I currently, a member of the Board of Directors or any advisory committee of Visual Data or Hotelview. From time to time, when Visual Data or Hotelview issues additional stock or repurchases its own stock, a letter of consent is required from Goldstein Lewin & Co., since we were on record as being the auditors on the September 30, 1996 financial statement. Because of this letter, we must maintain independence from Visual Data and Hotelview. Pursuant to SEC and AICPA regulations, no employees of Goldstein Lewin & Co. are permitted to own stock in Visual Data or Hotelview or be a member of the Board of Directors of Visual Data or Hotelview. To my knowledge, all the employees of Goldstein Lewin & Co. adhere to that independent status.

1900 N.W. Corporate Blvd.
 East Building Suite 300
 Boca Raton, Florida 33431
 (561) 994-5050

Broward (954) 429-8555
 Dade (305) 944-3582
 Palm Beach (561) 737-0309
 FAX (561) 241-0071

Fort Lauderdale Office
 4850 West Prospect Road
 Fort Lauderdale, FL 33309
 (Reply to Boca Address)



Lorraine Christine Hoffman, Esq.
 Assistant Staff Counsel
 The Florida Bar
 File No. 2003-51, 109(15C)

Simon Bernstein
 Eliot Bernstein
 Board of Directors
 IVIEWIT, Inc.
 June 7, 1999

Possible Conflict of Interest – Page Two

The September 30, 1996, September 30, 1997 and September 1998 tax returns were prepared by the following employees of Goldstein Lewin & Co.:

9/30/96	Natalie Kelly, CPA
9/30/97	Nicholas Buscemi, CPA
9/30/98	Nicholas Buscemi, CPA

I will be forwarding to you, under separate cover, notarized disclosures of confidentiality by employees of Goldstein Lewin & Co. regarding Iviewit, Inc., Visual Data Corporation and Hotelview Corporation.

If I can be of further help, please advise.

Sincerely,

GOLDSTEIN LEWIN & CO.
 Certified Public Accountants

Gerald R. Lewin
 Gerald R. Lewin, CPA

GRL/bjw

c: Christopher Wheeler, Esq.

f:\data\99\grl\conflict.doc.

STATE OF FLORIDA
 COUNTY OF PALM BEACH

Sworn to and subscribed before me this 7th day of June, 1999, by
Gerald R. Lewin who is personally known or who has produced
 _____ as identification.



Lisa Scarabino
 Signature of Notary Public
Lisa Scarabino
 Printed Name of Notary Public
 State of Florida at Large
 My Commission No.
 My Commission Expires:

Wednesday, April 30, 2003

Mr. Eliot I. Bernstein
10158 Stonehenge Circle
#801
Boynton Beach, FL. 33437-3546

Dear Eliot,

I have spent the past several evenings reviewing the depositions taken from Wheeler, Utley and Rubenstein and I am stunned. The extent of their lies and their orchestrated obfuscation compels me to reduce to writing some of the experiences that I had with these men. Please use this letter and the statements contained herein as my sworn statement of fact in your continuing effort to expose the truth, punish the evil and reward the deserving.

As a friend of Eliot's, since childhood, I was aware of iviewit from its beginnings but it was only after learning from Chris Wheeler about Ken Rubenstein's favorable opinion regarding iviewit's video and imaging technologies that I became seriously interested in the company. I resigned from a lucrative senior management position with Prudential Securities to help Eliot with his "project". Ultimately, I invested over \$20,000 and declined significant career opportunities in order to begin formally working for iviewit in the fall of 1999. Amongst the most egregious of the statements contained in the depositions is that made by Ken Rubenstein when he claims he does not know iviewit or anything about its technologies or processes. Ken is one of the primary reasons why I and many others invested their time and resources in the company. It was the extremely positive opinions of this highly respected attorney, who has direct links to the MPEG patent pool, which compelled so many of us to make the commitments that we made. Mr. Rubenstein is lying in his deposition.

Similarly, Chris Wheeler denies having any role in the patent work performed for iviewit other than referring us to patent counsel that ultimately ripped us off (but that's a different issue). Eliot, you have done a fine job putting together the billing evidence which is irrefutable. Not only did Wheeler play an instrumental and ongoing role in the handling of the patents, he was the primary contact point with Ken Rubenstein. I also remember Chris, in a meeting held at Real 3D, espousing the novelty of iviewit's inventions and discussing the apparent absence of any prior art in this area. In addition, Chris publicly shared Ken Rubenstein's opinion that the iviewit technologies were "novel". It was during this meeting of Intel and Lockheed engineers that a member of Real 3D's senior management, Rosalie Bibona, stated that iviewit's inventions could be worth billions of dollars. Wheeler states in his deposition that he was unfamiliar with any video inventions until sometime after the Real 3D meeting. Mr Wheeler is lying and everyone present at that meeting can testify to that fact. I was at a meeting held at Si Bernstein's house where Eliot Bernstein, Gerry Lewin, Chris Wheeler, Si Bernstein and Hassan Mia were in attendance. This meeting took place prior to the Real 3D meeting and its purpose was to show Hassan the video streams. It was at this meeting that

Hassan Mia stated "... if what I'm seeing is true, you've found the Holy Grail". The term "Holy Grail" can be found in many early versions of iviewit's business plans.

Let's talk about Brian Utley. This man is a stammering buffoon. Were it not for his resume full of accomplishments and the glowing recommendation of our trusted counsel, he probably never would have passed an initial candidate screening. Unfortunately, we learned too late that many of Brian's accomplishments were fabricated and our trusted advisor, Chris Wheeler, was a liar. I remember a meeting of Eliot, Guy Iantoni, Brian Utley, Mike Reale, Si Bernstein, Chris Wheeler and two investment bankers from Wachovia, Mr. Joe Lee and his associate (I forget his name). Guy and I had prepared a detailed sales forecast that Joe Lee later referred to as the most complete and detailed he'd ever seen. Brian's task was to complete the financials for Joe's review. The work that he presented to Joe Lee was pitiful; it was incomplete, inaccurate and inadequately referenced. In short, it was a disastrous embarrassment. We soon learned that that was the best Utley could deliver. Joe Lee insisted that I complete the financial projections for the business plan and that Utley be removed from the project. This is the sort of talent that our trusted advisor, Chris Wheeler, brought to his client!

From unauthorized patent disclosure to Danny Sokoloff without the protection of an NDA to outright patent sabotage through the use of bad math in patent applications, Utley never failed to disappoint. He was equally inept in corporate matters. I notified Brian on numerous occasions of the firm's responsibility to communicate to shareholders at least once per year and that iviewit was in default on its notes for not having made an interest payment. Like a child, he chose to bury his head in the sand instead of addressing the problem. His exorbitant use of T&E monies is legend and is only exceeded by his inability to complete a sentence without the excessive use of the word "um".

As they say, "hindsight is 20/20". In this case, it's now clear that Wheeler never had iviewit's interests in mind. He was positioning himself and his friends to benefit from iviewit's inventions and creativity. What makes his crime so heinous is that he masqueraded as our friend.

Sincerely,

James F. Armstrong
126 Buttonwood Drive
Fair Haven, NJ. 07704
732-747-4353
email: jimarmstrong@comcast.net

Date: 12/11/02

Dear Eliot;

I wanted you to know how I feel about all that I have read recently. As a shareholder and someone that has been around this company since the beginning, I don't know how lawyers like Chris Wheeler and law firms like Proskower Rose could allow statements in a business plan that are not true. Therefore, if the business plan were correct then Mr. Utley would have to be lying under oath. In today's world of fair disclosure, this kind of inconsistency makes me outraged. As a shareholder I encourage and would support action taken to bring any wrongdoing to justice. If nothing else, I am unwilling to allow these deceptions to continue. We should pursue action and be compensated for wrongdoing. I know that if Mr. Rubinstein had not been involved with Iviewit it would have significantly affected my decision to contribute funds when I did. His involvement was communicated to me by Mr. Utley, Mr. Wheeler as well as others involved with the company but as legal representation and president of the company they carried the greatest weight. These inconsistencies are unacceptable and criminal in my opinion. What can we do to bring resolution to this situation and whom do we hold accountable?

Sincerely;

Mitchell A. Welsch, CFP

Mitchell A. Welsch CFP

Eliot I Bernstein

Subject: FW: response to your letter

-----Original Message-----

From: Alyssa Zeiger [mailto:alyssa@lifeinsuranceconcepts.com]
Sent: Wednesday, May 21, 2003 9:27 AM
To: iviewit@bellsouth.net
Subject: FW: response to your letter

Alyssa Zeiger
Executive Assistant
7700 Congress Avenue Suite 3209
Boca Raton, Fl 33487
Phone 561-988-8984
Fax 561-988-0833
mailto:Alyssa@lifeinsuranceconcepts.com

-----Original Message-----

From: Alyssa Zeiger [mailto:alyssa@lifeinsuranceconcepts.com]
Sent: Friday, May 16, 2003 10:33 AM
To: 'iviewit@worldnet.att.net'
Cc: 'simon@lifeinsuranceconcepts.com'
Subject: FW: response to your letter

Alyssa Zeiger
Executive Assistant
7700 Congress Avenue Suite 3209
Boca Raton, Fl 33487
Phone 561-988-8984
Fax 561-988-0833
mailto:Alyssa@lifeinsuranceconcepts.com

-----Original Message-----

From: Alyssa Zeiger [mailto:alyssa@lifeinsuranceconcepts.com]
Sent: Wednesday, May 14, 2003 9:04 AM
To: 'iviewit@worldnet.att.net'
Cc: 'simon@lifeinsuranceconcepts.com'
Subject: response to your letter

Eliot,

Here is my account of those questions you of asked for regarding iviewit Technologies, Inc.

1. Not having Wheeler's testimony it's difficult for me to respond to the 1st question. However, Real 3d (Jerry Stanley) was introduced to us and their opinion including the opinion of their engineering staff was that the patents that we showed them were outstanding and extremely valuable. Mr. Stanley told myself, Eliot, Jerry Lewin and Chris Wheeler that we were onto something big.
2. The problems that were encountered by Ray Joah's work were that is seemed to be incomplete, sloppy and certainly not in a professional manner for which the billings indicated it were. With regard to Floey and Lardners work, there work also seemed to be incomplete with regard to accomplishing the patent approvals. It was also noted that including work with Mr. Utley

they were writing patents in his name.

3. In the same regard Mr. Utley told me when I confronted him with this that it was common for the writer to put new patents in his name but assured me that all patents were assigned to iviewit Technologies, Inc.. This was passed on to one of the partners at Proskover Rose and I was assured that this with in proper conduct.

4. With regard to Ken Rubenstein, I was told by Brian Utley and Chris Wheeler that he was a partner of Prokover Rose and that he was in fact over seeing our patent work and it also was mentioned that he advised the board of directors with regard to raising capital.

5. It is my opinion that Hank Powell a partner of Crossbow Ventures and also a member of the board of iviewit Technologies, Inc. violated his fiduciary responsibility as said board member to iviewit Technologies, Inc. by recommending iviewit Technologies, Inc. move forward and securing additional loans from Crossbow Ventures. He also told me that Crossbow had no intention of ever collecting on the notes but in fact it gave further protection of iviewit Technologies, Inc. from any other creditors. It is my opinion that this convinced the board of directors to vote on such loans.

6. With regard to Chris Wheeler's recommendation of Bryan Utley it's my opinion that he knew of the past problems Mr. Utley had with Montee Friedkin and withheld this information to myself and to Eliot.

7. My understanding of the relationship between Mr. Utley and Mr. Wheeler is that they are good friends both socially and professionally. Also they served on many boards together.

I believe this covers the pertinent questions you asked me for. I hope this helps.

Dad.

Alyssa Zeiger
Executive Assistant
7700 Congress Avenue Suite 3209
Boca Raton, Fl 33487
Phone 561-988-8984
Fax 561-988-0833
mailto:Alyssa@lifeinsuranceconcepts.com

Incoming mail is certified Virus Free.
Checked by AVG anti-virus system (<http://www.grisoft.com>).
Version: 6.0.483 / Virus Database: 279 - Release Date: 5/19/2003



EXHIBIT C



IVIEWIT HOLDINGS, INC.

By Facsimile

February 26, 2003

Thomas J. Cahill
Chief Counsel
First Judicial Department Departmental Disciplinary Committee
61 Broadway, 2nd Floor
New York, New York 10006

Re: General Complaint against Kenneth Rubenstein on Behalf of Iviewit Holdings, Inc. (a Delaware Corporation) ("Company")

Dear Mr. Cahill:

By way of introduction, I am President (Acting) of the above referenced Company, and write to file a General Complaint against the following member of the New York State Bar Association:

Kenneth Rubenstein
Proskauer Rose LLP
1585 Broadway
New York, NY 10036-8299
Tel.: 212.969.3185

Introduction

Kenneth Rubenstein, (hereinafter "Rubenstein"), believed to be a resident of the State of New York or New Jersey, and who at various times relevant hereto was either misrepresented to the Company as a partner of Proskauer Rose LLP (hereinafter "Proskauer") and later became a partner of Proskauer, and who provided legal services to the Company.

Moreover, beginning on or about September of 1998, the Company, through its agent and principal, Eliot I. Bernstein ("Bernstein"), began negotiations with Proskauer with regard to Proskauer providing legal services to the Company the purpose of which was to develop and market specific technologies developed by Bernstein and two others, which technologies allowed for the scaling, enlargement, panning and zooming of digital images and video without degradation to the quality of the digital image due to what is commonly referred to as "pixelation", the delivery of digital video using proprietary



scaling techniques, a combination of the image pan and zoom techniques and video scaling techniques, and the remote control of video and image applications.

Furthermore, Bernstein engaged the services of Proskauer and in turn Rubenstein, among others, through an engagement letter a true copy of which I attach herein as Exhibit "A", to obtain multiple patents and oversee US and foreign filings for such technologies including the provisional filings for the technologies as described above, and such other activities as were necessary to protect the intellectual property.

Additionally, upon information and belief, Rubenstein upon viewing the technologies developed by Bernstein, and held by the Company, realized the significance of the technologies, its various applications to communication networks for distributing video data and images and for existing digital processes, including, but not limited to digital cameras, digital video disks (DVD), digital imaging technologies for medical purposes and digital video, and that Rubenstein designed and executed, sometimes for himself or others similarly situated, deceptions, improprieties, and, even in certain circumstances, outright malfeasances by the disingenuous insertion of his own interests or the interests of third parties, who were other clients of Proskauer and Rubenstein, between the Company, as his client and together with its disclosed techniques, and the ultimate end users of its future OEM and other licensees, to the detriment and damage of the Company. Many of the malfeasances against the Company have also involved fraud against the US Patent and Trademark Office.

Secondly, while the Company was engaged in negotiations of technology agreements with including but not limited to both Warner Bros, a division of Time Warner Entertainment L.P. and its direct parent, AOL Time Warner (collectively "Warner Bros/AOLTW"), as to the possible use of the technologies of the Company, and despite the prior representations of Rubenstein, at a meeting held on or about November 1, 2000, by and between, among others, Rubenstein and representatives of Warner Bros/AOLTW as to the technologies of the Company, their efficacy, novelty and unique methodology, Rubenstein tortuously, the Company alleges, refused to subsequently make the same statements to representatives of Warner Bros/AOLTW and AOLTW, taking the position that "I have a conflict of interest in that they [Warner Brothers] are a big client of Proskauer, so I cannot comment on the technologies of Iviewit to any representatives of WarnerBros." or words to that effect in response to inquiry from Warner Bros/AOLTW's patent counsel as to the status and condition of the pending patents on the intellectual property.

Additionally, that Rubenstein, having served as an Advisor to the Board of the Company, was fully aware of the fact that the Company was in negotiations with Warner Bros/AOLTW as to the possible licensing of technologies and further funding of the operations of the Company, and further, Rubenstein as a partner of Proskauer, and despite his clear prior actions in representing the interests of the Company and having interest in stock of the Company as a partner of Proskauer (Proskauer owning two and one-half percent of the Company's founder shares) and still further as an Advisor to the Company's Board listed in all business plans, websites, etc., refused to answer questions as to the enforcement of the intellectual property of the Company with the intent and



knowledge that such refusal would lead to the cessation of the business relationship by and between the Company and Warner Bros/AOLTW and other clients familiar with the Warner Bros/AOLTW technology group and in negotiations with the Company, including, but not limited to Sony Corporation, the Viacom Inc. Paramount Pictures unit, Metro-Goldwyn-Mayer Inc., and News Corporation's Twentieth Century Fox division. Accordingly, the Company alleges, the actions of Rubenstein were and constituted an intentional and unjustified interference with the relationship by and between the Company and Warner Bros/AOLTW designed to harm such relationship and further motivated by the attempts to cover-up the conflict of interest in Proskauer's representation of both the Company and Warner Bros/AOLTW.

Finally, as a direct and proximate result of the conduct of Rubenstein, Warner Bros/AOLTW ceased business relations with the Company to the damage and detriment of the Company; the Company more specifically stipulates Rubenstein's actions and inactions directly below:

Specifics of General Complaint

Where the Company employed Rubenstein and Proskauer for purposes of representing the Company to obtain multiple patents and oversee foreign filings for such technologies including the provisional filings for the technologies as described above, and that pursuant to such employment, Rubenstein and Proskauer owed a duty to ensure that the rights and interests of the Company were protected, Rubenstein and Proskauer neglected that reasonable duty of care in the performance of legal services in that they:

- a. Failed to take reasonable steps to ensure that the intellectual property of the Company was protected; and,
- b. Failed to and/or inadequately completed work regarding patents, copyrights and trademarks; and,
- c. Failed to list proper inventors of the technologies based on improper legal advise by Proskauer, and in turn Rubenstein in his lead technological role, that foreign inventors could not be listed until their immigration status was adjusted leading to further erroneous billings by Proskauer for frivolous immigration work. This resulted in the failure of the patents to include their rightful and lawful inventors; and,
- d. Failed to ensure that the patent applications for the technologies, contained all necessary and pertinent information relevant to the technologies and as required by law; and,
- e. Failed to secure trademarks and copyrights and failed to complete trademark and copyright work for the use of proprietary names of the Company and the source codes for the technologies of the Company in relation to the intellectual property, and;
- f. Engaged in unnecessary and duplicate corporate and other work; and,
- g. By redacting information from the billing statements regarding services provided so to as to give the appearance that the services provided by Proskauer were limited in nature, when in fact they involved various aspects of intellectual property protection; and,



h. By knowingly and willfully representing and agreeing to accept representation of clients in conflict with the interests of the Company, without either consent or waiver by the Company

i. Allowed the infringement of patent rights of the Company and the intellectual property of the Company by other clients of Proskauer and Rubenstein. Failed to submit to patent pools overseen by Rubenstein Iviewit patents for inclusion to such pools, including but not limited to MPEG 2, MPEG 4, and DVD and;

j. Aided a one Raymond A. Joao, represented at first as a member of Proskauer and Rubenstein's underling, but later discovered to be an of counsel to Meltzer Lippe Goldstein & Schlissel LLP. of Mineola, N.Y. in filing patents for the Company's intellectual property by willfully withholding pertinent information and further filing patents in an untimely misrepresented manner. That Mr. Joao who was contracted to procure patents for the Company has now applied for 70+ patents in his own name, many of which appear to be ideas learned while representing the Company.

k. That due to the discovery of many of the above described events the Company's lead investor Crossbow Ventures (a referral of Proskauer Rose) of West Palm Beach, Fla., pulled funding on the Company; it is the Company's belief that this is simply another attempt by, among others, Rubenstein and Proskauer to seize the Company's assets through frivolous actions and malfeasances, when answers to the patents approval and value will be determined in a very short time.

Lastly, the negligent actions of Rubenstein and Proskauer resulted in and were the proximate cause of loss to the Company; today, the Company's processes are believed to be on digital camera's, DVD's and virtually all Internet and Broadcast streams of video; true copies of exhibits and witnesses are available on request and/or I will, on behalf of the Company, present them according to proof at commencement of investigation into this General Complaint.

Due to the highly sensitive nature of the patent and copyright materials, exhibits and witnesses will be provided once formal protections have been established in regard to this complaint.



Very truly yours,

IVIEWIT HOLDINGS, INC.

By:  : Electronic Signature
Eliot I Bernstein
561.364.4240
President

 Electronic Signature for P. Stephen Lamont by Eliot I. Bernstein his attorney -in-fact

P. Stephen Lamont
Chief Executive Officer



Exhibit "A"



PROSKAUER ROSE LLP

2255 Glades Road
Suite 340 West
Boca Raton, FL 33431-7360
Telephone 561.241.7400
Elsewhere in Florida
800.432.7746
Fax 561.241.7145

NEW YORK
LOS ANGELES
WASHINGTON
NEWARK
PARIS

Christopher C. Wheeler
Member of the Firm
Direct Dial 561.995.4702

September 8, 1999

Mr. Brian G. Utley
iviewit LLC
c/o Goldstein Lewin
1900 Corporate Boulevard, Suite 300-E
Boca Raton, FL 33431

Re: Engagement Agreement for iviewit LLC

Dear Brian:

Thank you for the opportunity to represent iviewit LLC in connection with general corporate advice (the "Work") and such other matters as we may undertake on your behalf from time to time. As is our Firm's custom, we are writing to confirm our agreement regarding such representation.

Our fees for services performed will be billed at our regular hourly rates. Currently, these rates range from \$135.00 to \$385.00 per hour for all legal services performed by the Firm's attorneys in our Boca Raton office. The hourly rate charged by any particular attorney within the range mentioned depends on such factors as that lawyer's experience, familiarity with the subject matter being worked upon, and such other factors as have been determined by the Firm in establishing the normal hourly rates for its attorneys. Time spent by any legal assistant is currently charged at \$90.00 per hour.

In addition to the fees described above, you agree to reimburse and pay us for all disbursements made by us, and our customary charges for in-house services in connection with the legal services performed under this agreement, including document reproduction and facsimile charges, computerized legal research, overtime (if required), travel expenses, court filing fees, postage, messenger and overnight courier fees, long-distance telephone charges, document preparation charges, word processing, taxes and miscellaneous expenses.

We anticipate billing you on a monthly basis, with payment of all monies due within 30 days of receipt. We will send you periodic statements setting forth the amount of the fees, disbursements and charges to which we are entitled and the basis for their calculation. Although, as noted above, we will ordinarily bill you monthly for fees, disbursements and charges of the preceding

0894/40017-001 BRLIB1/240799 v1

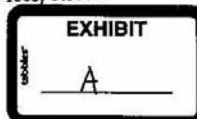

09/08/99 02:56 PM (2743)



PROSKAUER ROSE LLP

Mr. Brian G. Utley
September 8, 1999
Page 2

month, we may occasionally defer billing for a given month (or months) if the accrued fees and costs do not warrant current billing or if other circumstances would make it more convenient to defer billing.

We are waiving a retainer at this time, but we reserve the right to ask for one at any time.

You have the right to discharge us as your counsel in connection with the Work at any time, but such discharge shall not affect our right to be paid all our previously incurred but unpaid fees, and all our previously incurred but unpaid charges and disbursements, in accordance with this letter agreement.

We may from time to time, either at your request or at our own initiative, provide you with an estimate of fees or costs that we reasonably anticipate will be incurred in connection with the Work. It is understood that such estimates, which are predicated on a variety of assumptions, are subject to unforeseen circumstances and are by their nature inexact.

If you agree that the foregoing meets with your approval, please sign and return to me the enclosed copy of this letter as soon as possible.

We very much appreciate the opportunity to represent you in this matter.

Best regards.

Cordially,

Christopher C. Wheeler

0894/40017-001 BRLIB1/240799 v1

09/08/99 02:56 PM (274)

PROSKAUER ROSE LLP

1585 Broadway
New York, NY 10036-8299
Telephone 212.969.3000
Fax 212.969.2900

Steven C. Krane
Member of the Firm

Direct Dial 212.969.3435
skrane@proskauer.com

LOS ANGELES
WASHINGTON
BOCA RATON
NEWARK
PARIS

April 11, 2003

Via Hand Delivery

Thomas J. Cahill, Esq.
Chief Counsel
Departmental Disciplinary Committee
First Judicial Department
61 Broadway
New York, New York 10006

Re.: Complaint of Eliot I. Bernstein against Kenneth Rubenstein, Esq.
Docket No. 2003.0531

Dear Mr. Cahill:

This letter is in response to your March 6, 2003 letter to Kenneth Rubenstein and the accompanying complaint filed by Eliot I. Bernstein. As you would expect, both Mr. Rubenstein and Proskauer take this matter very seriously. Obviously, if you need any further information or documentation, we welcome the opportunity to assist in that regard.

Summary

Before addressing the allegations in detail, we would like to provide you with a summary of certain key points to be made below in our response:

- The Disciplinary Complaint of Mr. Bernstein must be understood in the context of a fee litigation brought by Proskauer against Mr. Bernstein's company Iviewit to collect outstanding fees of \$370,000 and the fact that Iviewit is a failed "dot.com" company looking for someone to blame for its failure.
- For Mr. Bernstein's allegations to be true, Mr. Rubenstein and Proskauer would have had to act totally against their own economic interests. Proskauer owns 2.5% of Iviewit. Why would Proskauer engage in an alleged conspiracy to cause Iviewit \$10 billion in damages, and thereby cause Proskauer itself to lose \$250 million? This is an amount

more than twenty times larger than the cumulative amount paid to Proskauer by its largest client in the 2002 fiscal year.

- Iviewit's own conduct shows that it does not really believe the allegations in the complaint. While Iviewit's CEO, Mr. Bernstein, is alleging that in the years 2000 and 2001 Mr. Rubenstein participated in a conspiracy to steal Iviewit's technology, on November 20, 2002, Iviewit presented Mr. Rubenstein with a letter requesting that he perform legal work for Iviewit. The Committee should consider how a party could almost simultaneously make serious allegations with respect to the conduct of an attorney and also request (or more accurately, pressure) the very same attorney to represent it.
- Mr. Bernstein has presented no evidence whatsoever to support the allegations in the complaint. In contrast, the deposition and documentary evidence presented below, show that the accusations are without merit. The evidence shows Mr. Rubenstein performed no patent work for Iviewit and engaged in no activities whatsoever that were adverse to Iviewit.
- Excerpts of Mr. Bernstein's deposition taken in the aforementioned litigation show that he lacks credibility with respect to the allegations in the complaint.

Background

The complaint relates to an attorney-client relationship between Proskauer (primarily its Boca Raton, Florida office) and several corporations bearing the name "Iviewit," of which Mr. Bernstein was a principal. Christopher Wheeler, a partner resident in Proskauer's Boca Raton office, was primarily responsible for representing Iviewit as general corporate counsel from approximately December 1998 through May 2001, when Proskauer withdrew from its representation due to Iviewit's nonpayment of Proskauer's legal bills. During this two and a half year relationship, approximately twenty Proskauer attorneys in its Florida and New York offices performed a vast array of corporate, securities, restructuring, and refinancing work for the Iviewit entities. However, as will be shown below, neither Proskauer nor Mr. Rubenstein performed any patent work for Iviewit.

Iviewit fell victim to the same plague that affected many "dot.com" companies during this time period -- a lack of funding. As a result, Iviewit suffered financial problems, and amounts owed to Proskauer continued to grow. Ultimately, Iviewit owed Proskauer a total of almost \$370,000 for legal services by the time Proskauer ceased to represent it. When Iviewit was unable to arrive at a satisfactory payment arrangement, Proskauer filed a lawsuit in May 2001 in Palm Beach County, Florida Circuit Court (the "Litigation") seeking to collect its attorneys' fees. The action is entitled *Proskauer Rose LLP v. Iviewit.com, Inc. et al.*, Case No. CA 01-04671 AB (the

“Litigation”), and is currently set for trial in West Palm Beach, Florida on May 28-29, 2003. A copy of the Amended Complaint filed in the Litigation is attached hereto as **Exhibit 1**.

On January 28, 2003, after the Litigation had been pending for over 21 months, Iviewit sought leave to assert what it contended was a **\$10 billion** counterclaim, raising allegations similar to those contained in Mr. Bernstein’s complaint against Mr. Rubenstein. A copy of the proposed counterclaim is attached hereto as **Exhibit 2**. The Court denied Iviewit’s motion for leave to amend by order dated February 4, 2003, a copy of which is attached as **Exhibit 3**. Mr. Bernstein’s complaint against Mr. Rubenstein followed on the heels of that denial.¹

On January 31, 2003, Mr. Bernstein’s deposition was taken in the Litigation. At that time, Mr. Bernstein offered sworn testimony of what he described as a conspiracy, occurring in 2000 and 2001, to steal his technology. According to Mr. Bernstein, the conspiracy was set in motion by Mr. Wheeler, along with such alleged co-conspirators as Mr. Rubenstein, Iviewit’s former President (Brian Utley), special counsel at the nationally known law firm of Foley & Lardner (William Dick), and another lawyer previously employed by the law firm Meltzer, Lippe, Goldstein & Schlissel, LLP (Raymond Joao).² According to Mr. Bernstein’s sworn testimony, this plot involves an alleged death threat made by Iviewit’s former President and Chief Operating Officer, which, as Mr. Bernstein testified, has caused him to fear for his life and, as we will show below, has caused Mr. Bernstein to believe that Proskauer is “evil.”

Obviously, there was no murder plot, no conspiracy, and no attempt on the part of anyone to injure Mr. Bernstein or his business. We point this out only to highlight the rather extreme and unfounded nature of the accusations leveled against a whole host of attorneys, at several law firms throughout the United States. We respectfully suggest that, viewed in context, Mr. Bernstein’s submission to the Committee is simply an ill-advised litigation tactic that is devoid of any factual or legal support. Unfortunately, Mr. Rubenstein is simply one of several attorneys caught in the crossfire of a fee dispute. Regardless of Mr. Bernstein’s motives, his accusations are squarely negated by the record.

Despite Mr. Bernstein’s allegations of malpractice and “malfeasance,” as recently as November of this past year (well after the alleged malfeasance and malpractice was alleged to occur), Iviewit sought to enlist Mr. Rubenstein’s assistance:

¹ Contemporaneously with the filing of the complaint against Mr. Rubenstein, Mr. Bernstein also filed a similar complaint against Mr. Wheeler with the Florida Bar. Mr. Wheeler’s response was filed on April 7, 2002 and the matter is currently pending.

² We understand that Mr. Bernstein also filed a similar complaint with the Departmental Disciplinary Committee against Mr. Joao.

“to review the conclusions of past and present patent counsel, and to further assist Iviewit in further defining the inventions in any intellectual property arena of [Iviewit’s] choosing”

A copy of Iviewit’s November 20, 2002 correspondence to Mr. Rubenstein is attached as **Exhibit 4**. For obvious reasons, most notably the pendency of the Litigation, Mr. Rubenstein declined this request. Prior to that, but subsequent to the termination of Proskauer’s representation of Iviewit and filing of the aforementioned lawsuit, Iviewit had sought to capitalize on the existence of an attorney-client relationship between Mr. Rubenstein and Warner Bros. by essentially asking Mr. Rubenstein to vouch for Iviewit’s technology to a client contact at Warner Bros. Mr. Rubenstein refused this request, citing conflict of interest issues. This conduct of Iviewit shows that Mr. Bernstein and Iviewit are not serious about their own allegations.

As an aside, Mr. Bernstein also notes in his complaint to this Committee the fact that he gave a gift to Proskauer of a small percentage of stock in Iviewit. Mr. Wheeler testified in his deposition in the Litigation that Mr. Bernstein wanted to grant shares of Iviewit stock to Proskauer because Mr. Bernstein felt that “all members of his team should be stakeholders in his company.” (Wheeler dep. At 62-24). Mr. Utley also testified that it was Mr. Bernstein’s “personal decision” (Utley dep. At 241-9) to grant a small interest in Iviewit, LLC (a corporation that is no longer in business) to Proskauer “because of the quality of work that [Proskauer] had performed for the company over the prior six months.” Id. at 238-19. Clearly, there is no ethical prohibition to Proskauer accepting this gift of stock from Mr. Bernstein. But even more to the point, the fact that this gift was made at all provides compelling evidence to refute Mr. Bernstein’s conspiracy theories. If Proskauer owned 2.5 percent of Iviewit, LLC, why would, as Mr. Bernstein alleges, Proskauer engage in a conspiracy to cause \$10 billion in damages to Iviewit? Such conduct would be directly adverse to Proskauer’s economic interest by causing Proskauer to lose \$250 million. Simply put, Mr. Bernstein’s allegations make no sense.

I. The Issues Raised in Mr. Bernstein’s Complaint

As far as we can discern from Mr. Bernstein’s submission to the Committee, he appears to raise two main issues. They are summarized below, and our response is noted.

A. Patent Work: Most of Mr. Bernstein’s allegations derive from his claim that Mr. Rubenstein mishandled certain patent work. To the contrary, as we show below (see Section II), there is overwhelming testimonial and documentary evidence showing that this allegation is false. Approximately twenty Proskauer attorneys performed legal services for and billed time to Iviewit matters. Mr. Rubenstein wasn’t one of them. Of the almost \$370,000 owed by Iviewit for legal services rendered by Proskauer, Mr. Rubenstein did not bill a minute of time to the engagement. Further, even ignoring Mr. Rubenstein’s lack of involvement, no one else at

Proskauer performed patent work for Iviewit. Iviewit's patent work was handled entirely by patent attorneys at other law firms. Whether there were any errors or omissions with the patent work is immaterial. Proskauer simply did not perform that work.

B. Conflicts of Interest: Mr. Bernstein alleges that Mr. Rubenstein, through "deceptions, improprieties . . . , and outright malfeasances" : (i) represented other clients with a conflict of interest to Iviewit; (ii) allowed the infringement by other clients of Iviewit's "intellectual property rights"; (iii) tortiously interfered in Iviewit's relationship with Warner Bros.; and (iv) personally benefited, along with Proskauer clients, to the detriment of Iviewit. The reality is that Mr. Rubenstein engaged in no activities whatsoever that were adverse to Iviewit, there was no tortious interference, no personal profiting at the expense of Iviewit and, to Proskauer's knowledge, no other parties have infringed upon Iviewit's "intellectual property rights." (see Section III, below)³.

II. Neither Mr. Rubenstein Nor Proskauer Performed Patent Work for Iviewit

Mr. Bernstein's complaint is replete with allegations concerning alleged improper or mishandled patent work somehow overseen or performed by Mr. Rubenstein. But Mr. Bernstein cannot point to a single document relating to patent work which is signed by Mr. Rubenstein or any other patent attorney at Proskauer. The work performed by Proskauer is reflected in billing statements submitted to Iviewit on a monthly basis. Copies of these billing statements are attached hereto as **Exhibit 5**. Proskauer attorneys who performed legal services for Iviewit would record their time, and the bills submitted by Proskauer represent a compilation of those time entries. Importantly, in all of the bills submitted to Iviewit, there is not a single time entry for Mr. Rubenstein. The reason for this is simple : he did not provide legal services on behalf of Iviewit. Apparently realizing the significance of this fact, Mr. Bernstein claims without any factual basis that Proskauer improperly altered its billing statements. There is simply no truth to this unsupported accusation, which we find very troubling. The billing statements are attached to this response. Should you have any question whatsoever as to whether the bills are genuine, our billing file is available for your review.

In addition to Proskauer's billing statements, which are devoid of any time entries by Mr. Rubenstein, both Proskauer attorneys and corporate representatives of Iviewit have confirmed under oath that neither Mr. Rubenstein nor Proskauer performed any patent work for Iviewit.

In short, the deposition testimony in the Litigation and the documentary evidence unequivocally establish that Mr. Rubenstein did not perform any patent work for Iviewit. To the contrary, all of Iviewit's patent work was performed by Raymond Joao, who at the time was employed by Meltzer Lippe, and thereafter by William Dick of Foley & Lardner. This is confirmed by the

³ We note that Iviewit has not been able to secure any patents on its technology, so we are not even aware of what "intellectual property rights" Mr. Bernstein is referring to.

depositions taken during the course of the Litigation, including that of Iviewit's former President and COO, Brian Utley, who testified that "Rubenstein and Mr. Wheeler, I'll repeat, had nothing to do with the patents" (Deposition of Brian Utley ("Utley dep.") at 150-9) and "I'm not aware – other than referring Iviewit to Meltzer, Rubenstein never did any work for Iviewit." (*Id.* at 121-3). Moreover, Mr. Utley testified numerous times that Mr. Rubenstein, who is a patent attorney, simply recommended Mr. Joao's firm to Iviewit when asked for a recommendation for outside patent counsel. *Id.* at 70-4; 121-3. Mr. Utley also testified that he has never met Mr. Rubenstein. *Id.* at 121-20. Mr. Wheeler also verified that that Mr. Joao was Iviewit's patent counsel (Deposition of Christopher Wheeler ("Wheeler dep.") at 23-20) and that Mr. Rubenstein did not do any patent work for Iviewit (*Id.* at 24-11).

When asked to opine as to the veracity of an interrogatory answer submitted by Mr. Bernstein during the course of the Litigation which suggested that Proskauer played a role with respect to Iviewit's patent work, Mr. Utley was unequivocal in his response:

Q. The answer to [Eliot Bernstein's] Interrogatory 20 in Subparagraph Roman Numeral XI, 11, it says: "Chris Wheeler agreed to investigate charges that Rubenstein and the name J-O-A-O, which I think is Joao. . . . [w]ere forging and changing patent documents and leaving inventors off patents. Wheeler and Utley suggest using their friend William D-I-C-K, and then it looks like it's cut off, Foley & Lardner to correct the gross negligence uncovered in Rubenstein/Joao work."

How do you respond to that statement?

A. Well, Rubenstein was never involved in any of that work.

Q. Is that a misrepresentation?

A. That's a misrepresentation.

Q. Were there any charges by you or anyone at Iviewit that Joao was forging and changing patent documents and leaving inventors off patents?

A. No.

Utley dep. at 83-15.

Gerald Lewin, a certified public accountant and principal of the CPA firm of Goldstein, Lewin & Company in Boca Raton testified similarly. He testified that he was initially approached by Eliot Bernstein's father, Simon Bernstein, who is also Mr. Lewin's neighbor, and asked to be a consultant for the Iviewit entities. (Deposition of Gerald Lewin ("Lewin dep.") at 7-14). Mr. Lewin agreed and ultimately became a member of Iviewit's board of directors. *Id.* at 9-1. Mr. Lewin introduced Eliot and Simon Bernstein to Mr. Wheeler at Proskauer's Boca Raton office, after the Bernstein's asked Mr. Lewin for a referral to a national law firm to represent the Iviewit entities. *Id.* at 8-3. Like Messrs. Utley and Wheeler, Mr. Lewin testified that Proskauer did not perform patent work for Iviewit and that the patent work was handled by other law firms. *Id.* at 10-25; 17-16; 50-8. Further, Mr. Lewin confirmed that Mr. Rubenstein's only involvement with

Iviewit was to provide a referral to an outside law firm to handle Iviewit's patent work. *Id.* at 17-16.

Mr. Rubenstein, who was also deposed in connection with the Litigation, could not have been clearer as to the scope of Proskauer's representation:

- Q. Did you ever opine with regard to the validity of any patent applied for or received by Iviewit.com?
- A. Like I say, I was not in any way involved with getting patents for Iviewit.
- Q. What were you involved with, if you were, with Iviewit?
- A. The only thing I did for Iviewit is I referred them to another patent lawyer.
- Q. And who is that?
- A. A guy named Ray Joao.
- Q. And where did Mr. Joao work?
- A. I believe he was working at the time at my former law firm, Meltzer Lippe.

(Deposition of Kenneth Rubenstein ("Rubenstein dep.") at 23-4).

Finally, Raymond T. Hersh, Iviewit's former Chief Financial Officer, also confirmed in his deposition that Proskauer did not perform any patent work for Iviewit, and stated that Iviewit "always had separate patent counsel." (Deposition of Raymond Hersh ("Hersh dep.") at 12-25).

Thus, regardless of whether Mr. Bernstein is pleased or displeased with the patent-related services provided to Iviewit, Proskauer simply did not provide those services. Moreover, Mr. Bernstein's accusations relating to Mr. Rubenstein's involvement in Proskauer's representation of Iviewit are demonstrably baseless. Every fact witness other than Mr. Bernstein has confirmed Mr. Rubenstein's testimony that he was not actively involved in Proskauer's representation of Iviewit.

III. Mr. Rubenstein Did Not Engage in Any Conduct Adverse to Iviewit

Mr. Bernstein's complaint makes accusations that Mr. Rubenstein represented clients in conflict with Iviewit and failed to disclose such representations and/or secure conflict waivers from Iviewit. These accusations are factually unsupportable.

Although Mr. Bernstein alludes to some alleged conflict involving Warner Bros., there is no merit to any such claim. While it is true that Proskauer provides legal services to Warner Bros. in various contexts, none of them involve taking a position adverse to Iviewit and, in fact, none of them even related to Iviewit at all. Aside from a brief review of a draft confidentiality

agreement with Warner Bros. by a lawyer in our Boca Raton, Florida office,⁴ Proskauer performed no work for Iviewit that is in any way related to its dealings with Warner Bros. More to the point, Mr. Rubenstein's only involvement with Iviewit concerning Warner Bros. was at the urging of Mr. Utley, who suggested that Mr. Rubenstein call his contact at Warner Bros., Gregory Thagard, to simply suggest that Warner Bros. talk to Iviewit. At a later date, subsequent to the termination of Proskauer's representation of Iviewit and after the filing of the lawsuit, Stephen Lamont, an Iviewit representative sought to enlist Mr. Rubenstein's assistance by having him tout Iviewit's product to Warner Bros. Mr. Rubenstein declined this request, specifically citing Proskauer's existing relationship with Warner Bros.

In short, when asked by Iviewit to do so, Mr. Rubenstein refused to place himself in a potential conflict of interest situation. And while Mr. Bernstein labels Mr. Rubenstein's refusal as tortious, the reality is that his decision was strictly guided by ethical considerations and entirely justified under the circumstances. Certainly it cannot be said that Mr. Rubenstein had any obligation to tout Iviewit's product months after Proskauer ceased representing Iviewit and after the filing of the Litigation.

As for Mr. Bernstein's claim that Iviewit has suffered damages as a result of Mr. Rubenstein's refusal, the record in this matter clearly establishes that Iviewit had an independent relationship with Warner Bros. that continued on even after Proskauer's involvement with Iviewit ended. In fact, Iviewit's "Business Plan," attached hereto as **Exhibit 6**, reveals that Iviewit maintained an independent relationship with Warner Bros. well after Proskauer's representation of Iviewit ended. The Business Plan lists, at pages 35-36, "Gregory B. Thagard - Former Vice President, Advanced Technology Technical Operations, Warner Bros." and "David J. Colter - Vice President of Technology and Standards, Warner Bros." as members of Iviewit's advisory board. The Business Plan further details, at page 20, a relationship with Warner Bros. beginning in 2000 and lasting through November 2001 - six months after Proskauer ceased representing Iviewit.

Iviewit's independent relationship with Warner Bros. is further demonstrated by an email shown to Mr. Rubenstein during his deposition in the Litigation. The email, dated August 1, 2001 -- three months after Proskauer ceased representing Iviewit -- was sent by David Colter of Warner Bros. to Crossbow Ventures, and explains that Iviewit is "currently finalizing a contract with WB Online. . . ." A copy of the email is attached as **Exhibit 7**. The email not only refutes Mr. Bernstein's claim that Mr. Rubenstein somehow interfered with Iviewit's relationship with Warner Bros., it negates Mr. Bernstein's claim that Mr. Rubenstein or Proskauer somehow caused Crossbow Ventures to cease funding Iviewit, as the email shows a relationship between Iviewit and Crossbow Ventures well after Proskauer stopped performing work for Iviewit.⁵

⁴ The attorney in Boca Raton was unaware that there were attorneys in the New York office who performed legal services for Warner Bros.

⁵ We note that the email provides a characterization of Iviewit's patents attributed to Mr. Rubenstein. We would like to note that this attribution is hearsay of hearsay, as Mr. Rubenstein has never spoken to the writer of the email.

Mr. Bernstein's complaint also alleges that Mr. Rubenstein served as a member of Iviewit's advisory board. Although the relevance of this claim is unclear, there is no truth to it. Iviewit apparently listed Mr. Rubenstein as an advisory board member on its website without Mr. Rubenstein's permission. Indeed, Mr. Utley confirmed at his deposition that Mr. Rubenstein was not on Iviewit's advisory board:

- Q. Okay. So Rubenstein's sole role, from what you understand, is he referred Iviewit to the Meltzer Lippe Law Firm in New York?
- A. Yes.
- Q. Was he ever part of an advisory board or was he an advisory board member to Iviewit? And we're talking about Mr. Rubenstein.
- A. I have never used him as an advisory board member.
- Q. Are you aware of whether or not he ever attended any board meetings with the directors of Iviewit?
- A. He never attended a board meeting. I've never met the man.

Utley dep. 121-6. In fact, Mr. Wheeler had discovered that both he and Mr. Rubenstein had been listed, without their permission, as advisory board members on Iviewit's website. Mr. Wheeler asked Iviewit to remove their names from the website in the Spring of 2001.

Finally, as for Mr. Bernstein's unspecific claim that Mr. Rubenstein somehow inserted his own interests or the interest of third parties ahead of Iviewit, such allegation is absurd. The overwhelming testimony of third parties and documentary evidence shows that, other than placing a gratuitous call to his contact at Warner Bros. and recommending Mr. Joao as outside patent counsel, Mr. Rubenstein had nothing to do with Iviewit. In the event the allegations are related to Iviewit's patent applications, we would like to point out to the committee that WIPO (World Intellectual Property Organization) has published Iviewit's PCT patent applications in its database. Please go to <http://ipdl.wipo.int/>. Copies of the cover pages of Iviewit's published applications as obtained from the aforementioned WIPO website are attached hereto as **Exhibit 8**. We note that these patent applications list Foley & Lardner as Iviewit's patent attorneys.

IV. Mr. Bernstein's Accusations Must Be Considered In Light Of His Recent Deposition Testimony

Mr. Bernstein's deposition testimony in the Litigation, taken just over a month ago, provides important context for consideration of his charges against Mr. Rubenstein. Almost irrespective

We would also like to note that the characterization is not one that Mr. Rubenstein could have provided. First of all, Iviewit has no patents (only patent applications). Second of all, Mr. Rubenstein never did any legal work which could form the basis of an opinion with respect to Iviewit's patent application.

of the topic of questioning being pursued, Mr. Bernstein's testimony drifted into tales of murder, conspiracy, and theft involving several lawyers of national law firms and well respected businessmen and philanthropists:

* * *

A. . . . Well, my attorney Caroline has been working with people to protect me. Utley came out after being terminated, and they found patents had been written into his own name going to his house without assignment to the company, et cetera.

And [Brian Utley] came out and basically told me that my life was in danger if I continued to pursue to be vocal about the fact that, you know, his background was clouded and that these patents were found -- well, that malfeasances were occurring is how I could basically couch that. And he said that him and Chris [Wheeler] would bring the company down brick by brick.

Q. Utley said this?

A. Yes.

Q. When was this?

A. This was around the end of 2000, in the January period.

Q. So you started learning about a conspiracy around that time?

A. Well, you know, the real -- you know, again, you ask about conspiracies. And you know, with hindsight, I could basically call it a conspiracy. But the real first conspiracies I learned of -- if you're asking for the whole conspiracy, is Ray Joao's work.

(Deposition of Eliot Bernstein ("Bernstein dep.") at 47-11).

As seen below, the alleged conspirators are numerous:

Q. You have no idea why Mr. [Hank] Powell was fired from Crossbow?

A. Perhaps for being involved in this conspiracy to steal my technologies.

Q. Mr. Powell was involved in the conspiracy?

A. I am not sure if Crossbow is involved, although they were referred to us by Chris Wheeler who spearheads the conspiracy. But, you know, you don't find these things out when there's a conspiracy until after the conspiracy is over.

Id. at 59-17.

Q. -- was [Maurice] Buchsbaum involved in the conspiracy?

A. Buchsbaum is related to Chris Wheeler, so we're not sure yet 100 percent.

Id. at 60-10.

Q. What did [Utley] tell you when he threatened your life?

A. He said: If you continue to expose these issues and pursue a course against me and Proskauer, we will kill you.

Q. Who is "we"?

A. Mean him, Chris Wheeler and Mike --

Q. Are you paraphrasing or are you quoting him?

A. I'm quoting him. And we will bring you down brick by brick by brick, your companies.

Q. He said: We will kill you --

A. Yes.

Q. -- and we will bring you down brick by brick?

A. Correct. So I called my wife and moved her into a hotel in California. She packed up overnight to move our children into a hotel. And we so lived in a hotel until we could get adequately --

Q. When was this?

A. We told everybody this.

Q. When was this?

A. This is right around January of 2001.

Id. at 93-14.

Q. Did Mr. Utley threaten you in person or over the phone?

A. In person.

Q. Do you feel that he had the means to kill you?

A. Well, he was touting Mr. Wheeler and Proskauer as being uncovered at this point for some of these malfeasances, like his background education. Yeah.

Q. Do you feel that he had the means to kill you, is the question.

A. Yes. With those he was saying he's conspiring with absolutely.

Q. Who was he conspiring with to kill you?

A. Mr. Wheeler, Mr. Bill Dick of Foley & Lardner. These are some major law firms.

Q. So you felt at the time that if Mr. Utley was going to kill you, he was going to do it in conspiracy with Foley & Lardner and Proskauer Rose?

A. With members of those firms that he's good friends with.

* * *

Q. What other law firms were conspiring with Wheeler, Utley, and Proskauer?

A. Meltzer, Schnitzel & Gold (ph)--

Q. Meltzer Lippe --

A. Meltzer Lippe Schnitzel & -- I think Goldstein or something.

Id. at 98-10.

Q. Have you feared for your life because of this lawsuit?

A. You bet, every single day. I've hidden my children off the streets. I'm scared to death to leave my house. My wife is scared to death to leave the house.

* * *

Q. Do you think Proskauer Rose wants you dead?

A. Yes.

Q. Why?

A. Well, the technologies are valued to be worth billions; that, in itself, is a motive.

* * *

Q. Why did you come here today if you are afraid for your life?

A. I fear no evil.

* * *

Q. --in your mind you agreed to come here for your deposition today if this firm wants you dead.

A. I fear no evil. I fear no evil.

Q. Is Proskauer evil?

A. Yes. Because of these actions, yes.

Id. at 107-24.

Q. Why do you come [to Proskauer's offices] and -- you have been here about three days now to review the files.

A. Yeah.

Q. Why do you come here and spend the day here when you fear for your life?

Why don't you just have Kinko's come and pick the files up and copy them for you?

A. I fear no evil, A, okay; I expressed that on the record before.

* * *

You know, if I died tomorrow from a hiccup, perhaps, everybody would look back here.

Q. At Proskauer?

A. Absolutely.

Q. And think that --

A. Chris Wheeler.

Q. -- that they orchestrated an accidental death?

A. Correct. Or something, or purposely done.

Id. at 125-14.

Q. Do you think your lawyer fears for his life?

A. I asked him that the other day.

Q. What did he say?

A. He said he fears nobody. He doesn't care that you are big. He doesn't care how big you are, he is not afraid of you.

Q. Do you think he is?

A. Yeah.

Q. You think he's in fear for his life because of this lawsuit?

A. Yes. I think it has run across his mind that he is sitting on a can of worms that could lead to the destruction of three large law firms.

Id. at 117-1.

Q. Why did you move back to close proximity of Proskauer Rose, if you are in fear for your life of Proskauer?

A. I study the art of war, so deception and distance are often key tactics to warfare.

Somebody made a threat on me in their home ground, so I left their home ground to a ground where I have many legal friends. People to help me protect myself.

Q. Here?

A. No, California. I don't know shit here.

So -- and that's why I'm scared here. And I was scared for collateral damage to people like my parents, and whatnot, so I broke ties with them,

hardly talked to them over the last year and a half, didn't let them see their grandchildren, never flew back here, okay.

Now I am prepared to wage war and have my evidence and guns in lie, I have no fear of --

Q. When you say "guns," are you speaking metaphorically?

A. Yes, of course.

Q. Okay.

A. And so, it's best to be here so that I can present my case, and I am not worried about you anymore killing me too much.

Q. Proskauer?

A. Proskauer, because now I think you've realized that there's a lot of people behind it that you didn't see coming, or you weren't paying attention and suddenly you've got a case.

Id. at 118-19.

As can be seen, the "truth" regarding the Litigation and the claims asserted by Mr. Bernstein's complaint against Mr. Rubenstein proved to be a fluid concept in his deposition. As the deposition demonstrates, a person is either supporting Mr. Bernstein fully and unconditionally or is part of a conspiracy to destroy him. Mr. Bernstein's response to questions concerning Mr. Lewin and his possible involvement in a conspiracy is telling in this regard:

Q. Was [Gerald] Lewin part of the conspiracy?

A. Gerri just referred me to Chris [Wheeler].

* * *

Q. [w]ere you on the telephone during Gerri Lewin's deposition?

A. No.

Q. He testified in his deposition that the only reason the bills weren't paid was because there wasn't any money?

A. **Well, then, we might have a problem with him being involved in the conspiracy.**

Id. at 186-25.

Mr. Bernstein's deposition testimony concerning his claim of "destruction" of documents is equally telling. Without a shred of evidence, Mr. Bernstein was willing to swear to the "destruction" of documents simply because he had not seen them:

Q. Did you ever see with your eyes anyone at Proskauer destroying any documents pertaining to Iviewit?

A. No.

Q. Did anyone ever tell you that they saw anyone at Proskauer destroying documents relating to Iviewit?

A. No.

Id. at 169-13.

Q. So you are still sticking to your story that Proskauer destroyed documents

--

A. In my interpretation --

Q. -- but you have no personal knowledge of whether they did?

A. -- of the word destruction, because they are not present in any records that the company can now get, yes, they have been, since Mr. Wheeler was keeping records of them.

Q. So destroyed means missing to you?

A. Yes.

Id. at 238-6.

VIII. Conclusion

In order to assist you in your review of this matter, we have endeavored to provide you with specific references to deposition testimony and documents which refute Mr. Bernstein's assertions. In the process, we hope we have answered any questions you may have concerning Proskauer's representation of Iviewit and Mr. Rubenstein's lack of involvement in that representation. Mr. Bernstein's accusations are simply unfounded and in many respects scandalous. As can be seen, Iviewit's own officers and directors have given sworn testimony refuting each and every assertion made by Mr. Bernstein. Our files are open and available for your review should you have any questions concerning this matter or need any additional information or documentation.

Thomas J. Cahill, Esq.
April 11, 2003
Page 16

We thank you for giving us the opportunity to be heard.

Very truly yours,

A handwritten signature in black ink, appearing to read "S. C. Krane", with a long horizontal flourish extending to the right.

Steven C. Krane

Encl.

1

2

3 IN THE CIRCUIT COURT OF THE
4 15th JUDICIAL CIRCUIT IN AND
5 FOR PALM BEACH COUNTY, FLORIDA

6 -----X

7 PROSKAUER ROSE L.L.P.,

8 Plaintiff,

9 vs. CA 01-04671 AB

10 IVIEWIT.COM, INC., a Delaware
11 corporation, IVIEWIT HOLDINGS,
12 INC., a Delaware corporation,
13 and IVIEWIT TECHNOLOGIES,
14 INC., a Delaware corporation,

15 Defendants.

16 -----X

17

18

19

20 DEPOSITION OF KENNETH RUBENSTEIN

21 New York, New York

22 Wednesday, November 20, 2002

23

24

25

26 Reported by:
27 WENDY D. BOSKIND, RPR
28 Job No. 142586

29

□

Ken Rubenstein Deposition

2
3
4
5
6
7
8
9
10
11
12
13
14
15
16
17
18
19
20
21
22
23
24
25

November 20, 2002
11:06 a.m.

Deposition of KENNETH RUBENSTEIN,
held at the offices of Proskauer Rose
LLP, 1585 Broadway, New York, New York,
pursuant to Notice and Agreement,
telephonically pursuant to a Court
Order, before Wendy D. Boskind, a
Registered Professional Reporter and
Notary Public of the State of New York.

□

3

1
2
3
4

A P P E A R A N C E S :

PROSKAUER ROSE LLP

5 Ken Rubenstein Deposition
Attorneys for Plaintiff
6 2255 Glades Road
7 Suite 340 West
8 Boca Raton, Florida 33431-7360
9 BY: CHRISTOPHER W. PRUSASKI, ESQ.

10
11
12 SELZ & MUVDI SELZ, P.A.
13 Attorneys for Defendants
14 214 Brazilian Avenue
15 Suite 220
16 Palm Beach, Florida 33480
17 BY: STEVEN M. SELZ, ESQ.
18 (telephonically)

19
20
21 ALSO PRESENT:
22 ELIOT BERNSTEIN, ESQ.
23 (telephonically)

24
25

□

1
2 K E N N E T H R U B E N S T E I N ,
3 business address at Proskauer Rose
4 LLP, 1585 Broadway, New York, New York,
5 having first affirmed before the Notary
6 Public, (Wendy D. Boskind), was examined
7 and testified as follows:

Ken Rubenstein Deposition

8

9 EXAMINATION BY

10 MR. SELZ:

11 Q. Mr. Rubenstein, my name is
12 Attorney Steve Selz, I represent the
13 Defendants in the case of Proskauer Rose
14 versus IViewIt.com.

15 I am going to ask you a series of
16 questions in this deposition, and the first
17 thing I need to know is whether or not you
18 have had your deposition taken previously.

19 A. I have had my deposition taken
20 previously.

21 Q. On how many occasions has that
22 taken place, sir?

23 A. Several.

24 Q. "Several", more than a dozen?

25 A. No.

□

5

1 Rubenstein

2 Q. More than five?

3 A. No.

4 Q. Can you give me an approximate
5 number? Two or three?

6 A. I would say three or four.

7 Q. Okay, three or four. So you are
8 familiar with the way a deposition works; is
9 that correct, sir?

10 A. Yes.

11 Q. So if I ask you a question, unless
12 you ask me to rephrase it or somehow revise
13 the structure of the question, I will presume
14 then that you have understood what I have
15 asked you as it is posed.

16 A. If I think your question is of
17 improper form, unclear, or harassment, I am
18 going to object.

19 Q. Okay, I believe that would be not
20 for you to do but Mr. Prusaski, as your
21 counsel.

22 A. I will put any objection I want on
23 the record, in addition to Mr. Prusaski.

24 Q. So, you are representing yourself?

25 A. No, I am not, he is representing

□

6

1 Rubenstein
2 me, but I am going to put objections on the
3 record, if I want to.

4 Q. That's fine.

5 Now, starting off with, sir, could
6 you please state your full name?

7 A. Kenneth Rubenstein.

8 Q. "Kenneth Rubenstein." And where
9 is your place of employment currently,
10 Mr. Rubenstein?

11 A. Proskauer Rose.

12 Q. Where is that located?

13 A. 1585 Broadway, New York.

Ken Rubenstein Deposition

- 14 Q. And how long have you been
15 employed with Proskauer Rose?
16 A. About four, four-and-a-half years.
17 Q. Somewhere between 1997 and 1998
18 was your first date of employment?
19 A. I think it was in 1998.
20 Q. Do you remember a month?
21 A. Possibly June.
22 Q. June. Where were you employed
23 prior to your employment with Proskauer Rose?
24 A. I was with a law firm, Meltzer,
25 M-E-L-T-Z-E-R, Lippe, L-I-P-P-E.

□

7

- 1 Rubenstein
2 Q. Meltzer Lippe is located where?
3 A. Mineola, New York.
4 Q. Do you have an address that you
5 can recall?
6 A. On Willis Avenue, but I don't have
7 the address right now.
8 Q. Prior to Meltzer Lippe -- and
9 approximately what were the dates of your
10 employment at Meltzer Lippe?
11 A. About 1993 to 1998.
12 Q. And what did you do at Meltzer
13 Lippe?
14 A. I was an attorney.
15 Q. Did you have any specialization?
16 A. I was a patent attorney.

- 17 Q. Are you still a patent attorney?
18 A. Yes.
19 Q. Is that your role at Proskauer
20 Rose currently, is a patent attorney?
21 A. Yes.
22 Q. Are you a partner of Proskauer
23 Rose?
24 A. Yes.
25 Q. Are you a shareholder of Proskauer

□

8

- 1 Rubenstein
2 Rose?
3 A. One or the other, either partner
4 or shareholder.
5 I think it's a partnership.
6 Q. It's a partnership. Do you have
7 any ownership interest in the partnership in
8 the sense of obligations that go beyond what
9 some of the other partners have? In other
10 words, do you have an equity share? Do you
11 have any other claims with regard to an
12 interest in Proskauer Rose?
13 A. I have no idea.
14 Q. Prior to Meltzer Lippe, where were
15 you employed, sir?
16 A. Another law firm.
17 Q. Do you remember the name of that
18 law firm?
19 A. Marmorek, M-A-R-M-O-R-E-K,

Ken Rubenstein Deposition
20 Guttman, G-U-T-T-M-A-N, & Rubenstein.

21 Q. Were you the "Rubenstein" in the
22 name of the firm?

23 A. Yes.

24 Q. And you were a partner in that
25 firm?

9

1 Rubenstein

2 A. Yes.

3 Q. What were the dates of your
4 employment in that firm --

5 A. Oh --

6 Q. -- Marmorek Guttman & Rubenstein.

7 A. -- probably starting in the
8 Eighties, mid-Eighties, until 1993.

9 Q. And what was the area of your
10 practice, when you were with Marmorek --

11 A. M-A-R-M-O-R-E-K.

12 Patent law.

13 Q. Patent law. And your dates -- you
14 say you left Marmorek Guttman & Rubenstein and
15 went to Meltzer Lippe and then to Proskauer
16 Rose, but at all times you were a patent
17 lawyer --

18 A. Yes.

19 Q. -- is that a correct statement?

20 A. Yes.

21 Q. Is that a correct statement, sir?

22 A. Yes.

23 Q. You have to wait until I finish
Page 8

Ken Rubenstein Deposition

24 the question.

25 A. No, you are not getting the

□

10

1 Rubenstein

2 answers clearly in your head. You should take
3 better notes.

4 MR. SELZ: Move to strike as
5 non-responsive.

6 (MOTION TO STRIKE.)

7 A. That's fine, move to strike it.

8 Q. Sir, during that entire period of
9 time, then, you were a patent lawyer; is that
10 a correct statement of fact?

11 A. Yes.

12 Q. Are you familiar with something
13 that's called "pan and zoom technology"?

14 A. I am not sure what you mean by
15 that.

16 Q. Well, let me start very simply,
17 and say this. Are you familiar with a concept
18 that an image can be enlarged while being
19 transmitted on a narrow bandwidth?

20 A. I don't know what you are talking
21 about.

22 Q. Okay. Well, let me go back to
23 this, then, sir. Are you familiar at all with
24 the technology involved with IViewIt.com?

25 A. No.

1 Rubenstein

2 Q. Do you have any information at all
3 with regard to any of the IViewIt entities?

4 A. Not at this time, no.

5 Q. "Not at this time." Did you have
6 any information at any time in the past, sir?

7 A. Not that I know of right now.

8 Q. Do you have any files or records
9 indicating that you had any dealings with --
10 and I will go through a list here --
11 IViewIt.com, Inc.?

12 A. Not that I know of.

13 Q. IViewIt, LLC?

14 A. Not that I know of.

15 Q. UViewIt?

16 A. Not that I know of.

17 Q. IViewIt, Inc.?

18 A. Not that I know of.

19 Q. Have you ever heard of an
20 individual named Eliot Bernstein?

21 A. I might have.

22 Q. Well, sir, that's either a "Yes"
23 or "No" question.

24 A. Like I said, I think he works for
25 IViewIt, and I may have heard his name.

Ken Rubenstein Deposition
Rubenstein

1

2 Q. How about what is called the MPEG
3 Patent Pool, have you heard of that?

4 A. Yes, I have.

5 Q. Why don't you tell me what that
6 is.

7 A. Decline to answer at this time.

8 Q. Why do you decline to answer?

9 A. Irrelevant to this deposition.

10 Q. I'm sorry, irrelevancy is not an
11 objection that would allow you not to answer,
12 sir.

13 A. Make a motion to the judge. If he
14 orders me to tell you about it, I will tell
15 you.

16 MR. SELZ: Chris, are you
17 instructing your client not to answer?

18 MR. PRUSASKI: I am going to put
19 an question for relevancy based on the
20 court's granting of the motion and
21 limiting on the record, and if
22 Mr. Rubenstein declines to answer then
23 he is declining to answer.

24 And, just so I don't have to keep
25 objecting, Mr. Selz, to make this

□

13

1

Rubenstein

2 easier, my objection is continuing in
3 nature as to any questions regarding any

4 Ken Rubenstein Deposition
5 transactions for IViewIt that you are
6 going to ask Mr. Rubenstein if he was
7 involved in based on the court's
8 granting of the motion and limiting.

8 MR. SELZ: Let me go on the record
9 and say the discovery documents that
10 have been produced by the Defendants --
11 Plaintiff in this matter indicate
12 various dealings in which Proskauer Rose
13 was affiliated including dealings with
14 H. Wayne Huizenga, CrossBow Ventures,
15 Wachovia, a number of other entities
16 which are part of the discovery and have
17 been produced by the Plaintiffs pursuant
18 to a valid request for production, so to
19 the extent you are claiming it's subject
20 to any motion and limited, that's fine
21 with regard to the trial, and the
22 discovery you produced on your own
23 pursuant to a request for production
24 which has not been held invalid includes
25 these very matters.

□

14

1 Rubenstein
2 A. So why don't you tell me more
3 particularly what you want to know.

4 MR. PRUSASKI: Mr. Selz, let me
5 just respond to that.

6 There were never any affirmative

7 Ken Rubenstein Deposition
8 defenses asserted by the Defendants in
9 this matter that have anything to do
10 with particular transactions, the
11 defenses involved whether the bills
12 were --

13 MR. SELZ: Let's go --

14 MR. PRUSASKI: I get to finish
15 because --

16 MR. SELZ: Go ahead and finish.

17 MR. PRUSASKI: Thank you.

18 There were never any affirmative
19 defenses asserted by the Defendants in
20 this matter relating to anything other
21 than the amount of the bills. And, so,
22 to the extent that the court granted our
23 motion limiting it, the Defendants can't
24 put any evidence of any particular
25 transactions or alleged wrongdoing by
Proskauer on at trial, but to that

□

15

1 Rubenstein
2 extent I am going to ask Mr. Rubenstein
3 to answer your questions. If I feel
4 that they are becoming overreaching, I
5 will make -- or if you are extending too
6 far into what I think is a violation of
7 the court's granting of the motion of
8 limiting, I will make another objection.

9 MR. SELZ: And let me go on the

10 Ken Rubenstein Deposition
11 record, the motion of limiting is fine
12 with regard to anything presented at
13 trial. It certainly does not preclude
14 the scope of discovery from including,
15 in a deposition, questions which may
16 lead to discoverable evidence concerning
17 the bills and the services that were
18 provided, which is the basis for the
19 affirmative defenses.

19 MR. PRUSASKI: And I am aware that
20 you have some latitude with respect to
21 discovery under the rules.

22 MR. SELZ: And I think we have
23 pretty significant latitude under the
24 rules.

25 And with regard to your client,

□

16

1 Rubenstein
2 Mr. Rubenstein, indicating he is
3 refusing to answer, I believe you should
4 instruct him right now, under Florida
5 law, he doesn't have the right to refuse
6 to answer.

7 A. All right, I will answer the
8 question.

9 MR. PRUSASKI: I just said a
10 minute ago we will go ahead.

11 A. Anything you want to know about
12 the MPEGLA patent pool, that's public

13 information, it's is on a web site,
14 MPEGLA.com. You should go look at that
15 web site. Any public information that I am
16 entitled to tell you is on that web site.

17 Q. Well, I am going to ask you, sir,
18 in this deposition to give me that
19 information.

20 A. And I am just telling you to go
21 look at the web site.

22 MR. SELZ: Let the record show the
23 witness is refusing to respond to a
24 direct question.

25 A. That is an incorrect

□

17

1 Rubenstein
2 characterization of the record.

3 The record shows that I told you a
4 place where you can get the answer very
5 easily. There is no reason for you to make me
6 sit here and waste my time repeating to you
7 things you can easily read about.

8 Q. Well, sir, this is your testimony
9 at your deposition.

10 A. That's right, which you are making
11 me do. I consider the deposition nothing but
12 harassment, considering that I had nothing to
13 do with the company. It's just a form of
14 harassment.

15 You go read the web site, if you

16 want to know about it.

17 Q. Okay, so you are refusing to
18 answer?

19 A. I am not refusing.

20 Q. Other than advising me to go to a
21 web site --

22 A. I am not refusing to answer. I
23 did answer. Please stop characterizing my
24 testimony. I told you the answer. I told you
25 all publicly-available information about the

□

18

1 Rubenstein

2 MPEG patent pool can be found at
3 www.MPEGLA.com. You are free to go read it.
4 Please go read it and you will learn all you
5 need to know about it.

6 Q. So you are not going to tell me
7 what the "MPEG patent pool" is?

8 A. I told you you could go read it.

9 Q. Okay.

10 MR. SELZ: Chris, do you want to
11 instruct your witness, or deponent, or
12 client, at all in that matter?

13 MR. PRUSASKI: Do you have any
14 specific questions with respect to
15 IViewIt in the MPEG patent pool?

16 MR. SELZ: Yes.

17 A. All right, so why don't you ask me
18 those questions.

Ken Rubenstein Deposition

19 MR. SELZ: I want Mr. Rubenstein
20 to first explain to me what the "MPEG
21 patent pool" is, and then I will ask him
22 questions concerning exactly how it
23 relates to IViewIt.
24 In other words --
25 A. Okay, I will answer both your

□

19

1 Rubenstein
2 questions.
3 Q. Go ahead.
4 A. The "MPEG patent pool" is a
5 collection of patents owned by a group of
6 companies related to the MPEG 2 video
7 compression standard and, as far as I know, it
8 has nothing whatsoever to do with IViewIt.
9 Q. So it has no technology -- the
10 MPEG patent pool uses no technology in any way
11 related to any of the IViewIt entities or
12 their intellectual properties; is that your
13 testimony?
14 A. No, it's not my testimony.
15 Q. Okay.
16 A. My testimony is, it's a group of
17 patents chosen according to very specific
18 criteria related to the MPEG 2 standard and,
19 to my knowledge, has nothing to do with
20 IViewIt.
21 And please do not characterize my

22 words. Please do not rephrase them. If you
23 don't know what I said, you can ask the
24 reporter to read it back. But do not
25 characterize my testimony.

□

20

1 Rubenstein

2 MR. SELZ: Again, let the record
3 reflect the deponent is not being
4 responsive.

5 A. I am being very responsive.
6 Please stop characterizing my testimony. And
7 please stop putting things on the record that
8 are incorrect.

9 Q. Mr. Rubenstein, I am asking you
10 questions, and I am asking --

11 A. And you are not listening to the
12 answers very carefully, so -- I don't know how
13 much experience you have taking depositions --

14 MR. SELZ: Again, let the record
15 reflect that --

16 A. Stop interrupting my answers. Do
17 not interrupt me.

18 Q. Mr. --

19 A. Do not interrupt me.

20 Q. Mr. Rubenstein --

21 A. Let me finish.

22 Are you going to proceed to
23 continue to interrupt me or not?

24 Q. If you want to answer the

Ken Rubenstein Deposition
25 questions, I have no problem.

□

21

1 Rubenstein

2 A. Look, I answered your questions.

3 You are unable to keep track of what I am

4 saying.

5 So, please, if you don't know what

6 I said, ask the reporter to read it back, but

7 please do not characterize my testimony in

8 your own words.

9 Q. Okay --

10 A. Just don't do it.

11 Q. What I am asking you is this. Do
12 any of the members of the MPEG patent pool use
13 any of the technologies of IViewIt?

14 A. I would have no idea.

15 Q. Who is the person in charge of the
16 MPEG patent pool, sir?

17 A. Like I say, I advise you to check
18 their web site if you want to know information
19 about that patent pool.

20 Q. Well, again --

21 A. It's not me.

22 Q. Are you involved with the MPEG
23 patent pool, sir?

24 A. Yes.

25 Q. What is your position --

□

22

Ken Rubenstein Deposition

1 Rubenstein

2 A. I am counsel to MPEG, LLC.

3 Q. Do you advise the MPEG patent pool
4 with regard to legal issues?

5 A. That's privileged information.

6 Q. Not whether or not you advised
7 them on legal issues.

8 A. You are asking me -- I am not
9 going to discuss with you anything about
10 anything I do with any other client in this
11 law firm.

12 Q. Well, sir, I am not asking you the
13 substance of what you have advised them, I am
14 simply asking you whether or not you advised
15 them.

16 A. I told you, I am their counsel.

17 Q. Okay. Have you ever seen any of
18 the intellectual properties or technologies
19 that IViewIt has developed for scaled video?

20 A. Not that I recall at this time.

21 Q. Were you ever involved in any
22 patent applications for scaled video
23 technologies for IViewIt.com?

24 A. No.

25 Q. Did you ever review any patent

□

23

1 Rubenstein

2 application at all for IViewIt --
Page 20

Ken Rubenstein Deposition

3 A. Not that I recall.

4 Q. Did you ever opine with regard to
5 the validity of any patent applied for or
6 received by IViewIt.com?

7 A. Like I say, I was not in any way
8 involved with getting patents for IViewIt.

9 Q. What were you involved with, if
10 you were, with IViewIt?

11 A. The only thing I did for IViewIt
12 is I referred them to another patent lawyer.

13 Q. And who is that?

14 A. A guy named Ray Joao.

15 Q. And where did Mr. Joao work?

16 A. I believe he was working at the
17 time at my former law firm, Meltzer Lippe.

18 Q. And what date was this?

19 A. I don't recall.

20 Q. So, you were employed by Proskauer
21 Rose at this time?

22 A. Yes.

23 Q. And you referred IViewIt to
24 Meltzer Lippe?

25 A. I referred IViewIt to Ray Joao,

□

24

1 Rubenstein
2 who I believe was working at Meltzer Lippe at
3 that time.

4 Q. Who did you speak to at IViewIt,
5 sir?

Ken Rubenstein Deposition

6 A. I don't recall.

7 Q. Did you keep any notes of your
8 conversation with regard to this referral?

9 A. No.

10 Q. Did you speak to Mr. Joao with
11 regard to this referral?

12 A. I don't recall.

13 Q. Why did you refer this matter to
14 Meltzer Lippe?

15 A. Because it wasn't work I wanted to
16 undertake myself.

17 Q. And why was that?

18 A. Because I am not generally in the
19 patent prosecution business, in most cases.

20 Q. Did you ever meet with any members
21 of the board of directors of IViewIt.com?

22 A. Not that I know of.

23 Q. Were you ever involved in any
24 meetings with anyone concerning IViewIt.com?

25 A. No, not that I know of.

□

25

1 Rubenstein

2 Q. How about any representative from
3 Real 3 D?

4 A. Never heard of it.

5 Q. How about Warner Bros.?

6 A. Warner Bros. is a client here.

7 Q. Okay. Did you have any
8 discussions with Warner Bros. about IViewIt?

Ken Rubenstein Deposition

9 MR. PRUSASKI: Objection.
10 A. Any --
11 MR. PRUSASKI: Instruct him not to
12 answer.
13 (DIRECTION NOT TO ANSWER.)
14 A. Any conversation I made or had
15 with Warner Bros. would be confidential. I am
16 not saying there was or was not such a
17 conversation, it would be privileged.
18 Q. I am not asking you for the
19 contents of the conversation, I want to know
20 if there was one.
21 A. I am not saying -- I don't know if
22 there was one.
23 And if there was, I wouldn't tell
24 you about it, anyway.
25 Q. How about Hollywood.com?

□

26

1 Rubenstein
2 A. Never heard of it.
3 Q. Did you ever have any discussions
4 with anyone at Proskauer Rose concerning the
5 IViewIt Technologies?
6 A. Not that I recall.
7 Q. Did you have any discussions with
8 anyone -- let's say Chris Wheeler,
9 particularly, at Proskauer Rose with regard to
10 anything at IViewIt?
11 A. I might have, but I don't recall

Ken Rubenstein Deposition

12 anything about it at this time, if I did.

13 Q. Did you ever counsel anyone at
14 IViewIt concerning any matters regarding the
15 patent or patent applications?

16 A. Not that I recall.

17 Q. Did you keep any files yourself
18 with regard to IViewIt and any communications
19 with IViewIt?

20 A. I don't think so, no.

21 MR. PRUSASKI: Objection, asked
22 and answered.

23 Q. Did you ever play a role as an
24 advisory board member for IViewIt?

25 A. Not that I know of, no.

□

27

1 Rubenstein

2 Q. Well, sir, I am a little
3 confused. You normally would recall that you
4 would be on a board of directors --

5 A. I don't think I was on any such
6 board.

7 To my knowledge, I was on no such
8 board.

9 Q. And you never had any
10 communications with any board member from
11 IViewIt; is that a correct characterization --

12 A. I had a -- probably a phone call
13 or two with Brian Utley. I am not sure if
14 he's a board member or not.

Ken Rubenstein Deposition

15 Q. And what were the contents of your
16 conversation with Mr. Utley?

17 A. I don't recall.

18 Q. Did you ever talk to anyone at
19 Warner Bros. with regard to IViewIt?

20 A. You are asking for privileged
21 information, sorry.

22 Q. Well, whether or not you had
23 communications --

24 A. No, you are asking for the content
25 of communications.

□

28

1 Rubenstein

2 Q. No, I am not asking for the
3 content.

4 A. Yes, you are.

5 Q. Please listen to my question.

6 MR. PRUSASKI: Mr. --

7 Q. The question was, did you ever
8 discuss any matters concerning IViewIt with
9 anyone from Warner Bros., period. I am not
10 asking you for the content because, clearly,
11 if you want to assert a claim of privilege on
12 that, and Warner Bros. is a client of yours,
13 then you can assert it, but I am asking you
14 whether or not you had any discussions at
15 all. I am not asking you for the contents.

16 A. I am --

17 MR. PRUSASKI: Mr. Selz, I am
Page 25

Ken Rubenstein Deposition

18 going to object. I am instructing
19 Mr. Rubenstein not to answer. It's
20 privileged attorney/client
21 communication.

22 (DIRECTION NOT TO ANSWER.)

23 MR. SELZ: Not the fact of whether
24 or not he had any discussions --

25 MR. PRUSASKI: I am not arguing.

□

29

1 Rubenstein
2 We are not allowed, under the Florida
3 rules, to argue objections. I am
4 instructing him not to answer.

5 MR. SELZ: I understand.

6 MR. PRUSASKI: And I can't argue
7 with you.

8 MR. SELZ: Just so the record is
9 clear, your objection is it's
10 privileged, whether or not he even spoke
11 to Warner Bros.

12 MR. PRUSASKI: Yes, about IViewIt.

13 MR. SELZ: About IViewIt.

14 MR. PRUSASKI: Yes.

15 Q. Do you know who Greg Thagard is?

16 A. Yes, I do.

17 Q. Who is he?

18 A. He used to work at Warner Bros.

19 Q. He doesn't work with Warner Bros.
20 anymore; is that correct?

Ken Rubenstein Deposition

21 A. Correct.
22 Q. When did you represent Warner
23 Bros., sir?
24 A. Oh, that's not -- that's
25 privileged information, sorry.

□

30

1 Rubenstein
2 MR. PRUSASKI: I am going to
3 object for relevancy, and instruct the
4 witness not to answer. It's also
5 privileged.
6 (DIRECTION NOT TO ANSWER.)
7 MR. SELZ: I don't think case law
8 supports the position that when he
9 represented a client --
10 MR. PRUSASKI: Are we going to
11 argue every time there is an objection?
12 MR. SELZ: No, no, no.
13 A. We will litigate out the issue.
14 We will litigate it out. You know, make a
15 motion. We will fight it. We will see who
16 wins.
17 Q. Mr. Rubenstein again, you know,
18 this is your deposition --
19 A. I don't --
20 Q. -- I appreciate the fact that you
21 want to express your opinion. However,
22 Mr. Prusaski can tell you, this is not how
23 depositions are conducted in the state of

Ken Rubenstein Deposition

24 Florida.

25 A. Fine. I am not discussing

□

31

1 Rubenstein
2 anything about Warner Bros. The objection has
3 been put on the record. Let's move on.

4 MR. PRUSASKI: And, Mr. Selz, just
5 to make it clear, I am going to instruct
6 the client not to answer any questions
7 about any Proskauer clients under claim
8 of privilege and under claim of
9 harassment and under claim of the fact
10 that you are not allowed to put any of
11 this on at trial.

12 MR. SELZ: Well --

13 MR. PRUSASKI: And we can litigate
14 that with Judge Labarga.

15 Q. Now, I am asking you specifically,
16 sir, with regard to any specific meetings, how
17 about Real 3 D?

18 A. I never heard of Real 3 D.

19 Q. You never heard of them, okay.
20 That's what I was going to say.

21 Are you aware of any meeting that
22 happened between yourself and any
23 representatives of IViewIt, other than you
24 have already described?

25 A. Not that I recall. I may have

1 Rubenstein
2 also had a conversation with Lamont, but I am
3 not sure.
4 Q. Lamont, you spoke to Stephen
5 Lamont?
6 A. Possibly, yes.
7 Q. And that was concerning IViewIt?
8 A. Maybe, yes.
9 Q. Do you recall what the contents of
10 that conversation were?
11 A. No.
12 Q. How about Zackirul Shirajee, do
13 you know who he is?
14 A. No.
15 Q. How about Jude Rosario?
16 A. Don't know who he is.
17 Q. How about any awareness on your
18 part of any IViewIt inventions regarding zoom
19 imaging?
20 A. I have no knowledge at this point
21 in time of IViewIt technology.
22 Q. So you have no knowledge of scaled
23 video?
24 A. I didn't say that. I said I have
25 no knowledge of what IViewIt technology is at

Ken Rubenstein Deposition
Rubenstein

1

2 this point in time.

3

Q. Okay, why don't you explain to me
4 "scaled video", to the best of your
5 knowledge.

6

A. I don't know what you mean by
7 "scaled video".

8

why don't you explain to me what
9 you are talking about.

10

Q. well, what does that mean to you?
11 You seemed to indicate earlier in your answer
12 that you had some idea of what I was talking
13 about.

14

A. well, "scaled video" might refer
15 to changing the sizes of video images.

16

Q. And how is that accomplished?

17

A. I don't know. At this point in
18 time, I am sure there is a variety of
19 techniques to do it.

20

Q. Are you aware of any such
21 techniques that IViewIt was using?

22

A. No.

23

Q. Are you aware of any camera zoom
24 applications used in the IViewIt technology?

25

A. No.

□

34

1

Rubenstein

2

Q. How about combined scaled video
3 zooming video applications?

4 A. Not that I know of.
5 I am not saying they don't or do
6 exist, I am saying I don't know.
7 Q. Of course, it's to the best of
8 your knowledge, sir, I am not expecting you to
9 be on omniscient.
10 How about game applications?
11 A. I have no knowledge of what
12 IViewIt's doing.
13 Q. How about what they have done in
14 the past?
15 A. I have no knowledge of what they
16 have done in the past at this point in time.
17 Q. Is it that you have no knowledge
18 or you can't recall?
19 A. I don't know if I knew in the past
20 or didn't know in the past, I don't know now.
21 Q. So, in other words, sir, you have
22 no knowledge as to any technology that IViewIt
23 uses; is that correct?
24 A. At this point in time, that is
25 correct.

□

35

1 Rubenstein
2 Q. Did you have such knowledge in the
3 past?
4 A. I don't know whether I did or did
5 not, I don't know now.
6 Q. So, then, sir, you wouldn't have

7 any ability to know whether or not any of your
8 clients are using IViewIt technology; is that
9 correct?

10 A. I would have no idea.

11 Q. So it is possible, then, they
12 might be infringing on IViewIt's technologies?

13 MR. PRUSASKI: Object to the form.

14 A. What do you mean by "infringing"?

15 Q. Well, making use of IViewIt
16 technologies without the benefit of royalties
17 or some other kind of licensing.

18 A. I have no knowledge that IViewIt
19 has any proprietary rights in anything. And I
20 have no knowledge about what IViewIt's
21 technology is. So I have no knowledge about
22 who could be doing what.

23 Q. If IViewIt had technologies
24 concerning scaled video, let's say, and there
25 was some legally-protected interest in that

□

36

1 Rubenstein
2 technology, as a patent lawyer, would you
3 opine that the use of that by any other third
4 party would require either a licensing or
5 payment of a royalty?

6 A. I --

7 MR. PRUSASKI: Object to the form.

8 Q. You may answer the question.

9 A. I will answer the question. I

10 would not have an answer to that question in
11 the abstract, you are asking for complex legal
12 analysis of a situation where you are only
13 giving a vague hypothetical fact pattern, so
14 it's not possible to give an answer to that
15 question.

16 Q. Well, let me restate it, then,
17 maybe I can make it clearer for you, sir.

18 Let's say that IViewIt has
19 technology for camera zoom applications and
20 that technology is patented, and a client of
21 yours is making use of that technology without
22 the benefit of paying either a royalty or a
23 licensing agreement. Would there be legal
24 liability?

25 MR. PRUSASKI: Object to the

□

37

1 Rubenstein

2 form.

3 A. Why don't you explain more clearly
4 what you are trying to say.

5 Q. I thought I was trying to be
6 clear. Okay, let me try again.

7 Let's say specifically, and I
8 don't know if this particular entity is a
9 client of yours or not, but Sony used camera
10 zoom applications which were subject to a
11 patent or a patent pending by IViewIt.com, and
12 Sony made use of these technologies without

13 either a licensing agreement or without paying
14 a royalty. Would Sony be liable for damages
15 for use of this patented technology to
16 IViewIt?

17 A. Well, Sony's a client of the firm,
18 so I am not going to discuss what kind of
19 advice I might or might not give to Sony in
20 particular circumstances, you are asking for
21 privileged information.

22 Q. Okay. Then, instead of Sony we
23 will make it company X.

24 A. Like I say, you are asking for a
25 legal conclusion of mine, how I might advise a

□

38

1 Rubenstein
2 client in a particular fact pattern without
3 knowing the details. In order to answer that
4 question, I would have to study the patent in
5 question, the file history of the patent
6 before The Patent Office, the prior art of
7 record. I might have to look for other prior
8 art. I would also have to study what the
9 particular client is doing. I might have to
10 study what other proprietary rights the
11 company in question who owns those rights
12 might have before I would even conceive and
13 think about answering a question like that.
14 Q. We are doing this -- obviously,
15 you have the right to object if it's Sony.

16 what I am saying assuming, arguendo, this is a
17 valid and binding patent intellectual
18 property, that it is only enforceable under
19 the patent that's in place, and that there is
20 a clear case of infringement.

21 A. I answered the question to the
22 best of my ability already. It's on the
23 record.

24 If you want, we can ask the
25 reporter to read it back.

□

39

1 Rubenstein

2 Q. Your statement to me in response,
3 sir, was that you needed more specifics and
4 that you were unclear, and that you would have
5 to --

6 A. No, I told you that in order for
7 me -- I am going to repeat this once, just so
8 we are understanding it -- I told you in order
9 to advise a client in a particular situation,
10 I would have to study the patents in question,
11 the file histories of the patents before the
12 U.S. Patent Office, I would have to study the
13 prior art of record, I might study other prior
14 art, I would have to study the claims of the
15 patent, I would have to try to understand
16 their scope, I would have to try to understand
17 the technology that someone was trying to
18 apply the patents to, I would try to

19 understand whether there were other
20 proprietary rights besides patents in
21 question, and before I could answer the
22 question. I can't answer your question in the
23 abstract, it doesn't have a simple
24 straightforward "Yes" or "No" answer.

25 Q. well, assuming that all your

□

40

1 Rubenstein
2 review of the prior art and your review of the
3 application of the Patent Office and your
4 review of all those other documents that you
5 just mentioned indicated that it was a valid
6 and duly-enforceable patented right with
7 regard to a technology that was clearly
8 infringing on that patent right, would your
9 answer remain the same?

10 A. I answered the question to the
11 best of my ability.

12 Q. How long have you been a patent
13 lawyer, sir?

14 A. You know how long, at least --

15 Q. Go back --

16 A. -- more than 20 years.

17 Q. And how many patent cases have you
18 litigated?

19 A. I have litigated a number of them.

20 Q. How many is "a number of them"?

21 A. Quite a few.

22 Q. More than 50?
23 A. Probably not.
24 Q. More than 20?
25 A. Maybe.

□

41

1 Rubenstein

2 Q. Have any of those patent cases
3 dealt with an infringement claim?

4 A. They generally deal with
5 infringement claims.

6 Q. Could you tell me about the cases
7 that you have been involved with? Just naming
8 the cases.

9 MR. PRUSASKI: Objection.

10 Don't answer the question, it's
11 privileged.

12 (DIRECTION NOT TO ANSWER.)

13 MR. SELZ: The name of the cases
14 are privileged?

15 MR. PRUSASKI: Yes. And it's
16 harassment. He is a 20-year patent
17 lawyer at one of the largest law firms.
18 Why don't we need to go over this?

19 MR. SELZ: It seems to me he is
20 being very evasive about a lot of these
21 things.

22 MR. PRUSASKI: I don't think so.
23 You are asking a really simple
24 question that doesn't have a simple

25 answer.

□

42

1 Rubenstein

2 A. Yes, you are asking a question
3 that doesn't have a simple "Yes" or "No"
4 answer.

5 MR. PRUSASKI: And it is a
6 hypothetical, and he is not an expert.

7 Q. Have you ever met with Mr. Chris
8 wheeler?

9 A. I don't think I ever met him, no.

10 Q. Did you ever speak with him?

11 A. Possibly, yes.

12 Q. Do you have any specific
13 recollection as to when you spoke with him?

14 A. No.

15 Q. Have you ever billed any services
16 to IViewIt or any of the IViewIt entities?

17 A. As far as I know, I have not.

18 Q. Have you been included on a
19 billing statement for IViewIt --

20 A. As far as --

21 Q. -- on Proskauer Rose.

22 A. As far as I know, I have not.

23 Q. Did Mr. wheeler ever consult with
24 you, to the best of your recollection, with
25 regard to any issues concerning IViewIt?

□

43

Ken Rubenstein Deposition

1 Rubenstein

2 A. He might have, but I would not
3 recall the details at this time.

4 Q. would you have taken any
5 contemporaneous notes of those conversations?

6 A. Probably not.

7 Q. would you keep any other records
8 of those conversations?

9 A. I am not a big note taker of phone
10 conversations, so the answer would be no.

11 Q. would those conversations have
12 been reflected in any billing records that you
13 might keep?

14 A. Like I say, to my knowledge, I
15 never billed any services to IViewIt.

16 Q. well, I don't think that was my
17 question.

18 My question was, sir, if you did
19 have a conversation with Christopher wheeler
20 with regard to IViewIt, would it have been
21 reflected on your billing records?

22 A. Probably not, because it would
23 have been a minor short conversation.

24 Q. Did you ever come down to Florida
25 to meet with anyone from IViewIt?

□

44

1 Rubenstein

2 A. No.

Ken Rubenstein Deposition

3 Q. Did you ever make any
4 representation to any party that you can
5 recall with regard to IViewIt or its
6 technologies?

7 A. Not that I recall.

8 MR. PRUSASKI: Object to the form.

9 Q. Let me rephrase that. Have you
10 ever spoken to any third party with regard to
11 IViewIt's technologies?

12 A. Not that I recall at this time.

13 Q. Did you ever meet with anyone
14 named Stephen Filipek?

15 A. I don't know who he is.

16 Q. Were you ever included in any
17 business plan of IViewIt as a consultant or
18 any other representation as being involved
19 with the company?

20 A. Not that I know of at this time.

21 Q. If you were included on that
22 business plan as a consultant or advisor to
23 IViewIt, would you have consented to that or
24 would you have had to have consented to that?

25 A. I don't know whether I would have

□

45

1 Rubenstein
2 had to consent to it or not, and I don't know
3 if I would have consented or not.

4 Q. Have you ever seen a business plan
5 for IViewIt?

Ken Rubenstein Deposition

6 A. I don't know, I might have. I
7 might not have, I don't know.

8 Q. How about, did you ever speak to
9 anyone at Brian Utley?

10 A. I did have one or two phone
11 conversations with him.

12 Q. With regard to IViewIt?

13 A. Yes.

14 Q. And what were the contents of
15 those conversations?

16 A. I --

17 MR. PRUSASKI: Asked and answered.

18 MR. SELZ: I'm sorry.

19 A. And I will just answer it again,
20 for convenience, I don't know the details at
21 this point in time.

22 Q. How about Gerald Stanley?

23 A. I don't know who he is.

24 Q. Wayne Smith?

25 A. I don't think I ever had a

□

46

1 Rubenstein
2 conversation with Wayne Smith about IViewIt.
3 And Wayne Smith is a Warner Bros. in-house
4 attorney and, therefore, any conversation I
5 did have with him would be privileged.

6 Q. How about David Colter?

7 A. I am not sure who he is. I am
8 just not sure.

Ken Rubenstein Deposition

9 You might refresh my recollection
10 and tell me who he is. I am not sure who he
11 is.

12 Q. If you are not sure who he is, I
13 will not go any further.

14 How about a Hassan Miah?

15 A. I don't know who he is.

16 Q. How about Doug Che, with Sony?

17 A. I don't know who he is.

18 Q. Jerry Pierce, from Paramount
19 Viacom?

20 A. I don't know who he is.

21 Q. How about Aden Foley?

22 A. Don't know who he is.

23 Q. Chris Cook?

24 A. I don't know who Chris Cook is.

25 Q. It's Chris Cookson.

□

47

1 Rubenstein

2 A. Any conversation I have had with
3 Chris Cookson would be privileged.

4 Q. Okay. well, you know who Chris
5 Cookson is?

6 A. Yes, I do.

7 Q. Have you ever discussed IViewIt
8 Technologies with him?

9 MR. PRUSASKI: Don't answer the
10 question.

11 I am instructing him not to
 Page 42

Ken Rubenstein Deposition

12 answer.

13 (DIRECTION NOT TO ANSWER.)

14 Q. Did you ever become aware of any
15 problems with Raymond Joao's work as with
16 regard to patents for IViewIt?

17 A. Not that I recall at this time.

18 Q. Does Proskauer Rose maintain
19 patent counsel, other than yourself?

20 A. There are a number of patent
21 people in the law firm.

22 Q. Was there any particular reason
23 why IViewIt's patent applications were not
24 handled by Proskauer Rose?

25 A. Well, like I said, generally, I

□

48

1 Rubenstein

2 don't do patent prosecution work, as a general
3 matter.

4 Q. Did you see anything wrong or
5 faulty with Mr. Joao's work?

6 A. Like I say, I have no knowledge of
7 his work at this time, and don't recall ever
8 seeing anything faulty with it.

9 Q. Was there ever a time when
10 Mr. Joao was no longer employed by Meltzer
11 Lippe, to the best of your knowledge?

12 A. I think he did leave after a
13 certain period of time.

14 Q. And where did he go to work?

Ken Rubenstein Deposition

15 A. I have no idea.
16 Q. Do you have any knowledge as to
17 why Mr. Joao left or --
18 A. No.
19 Q. If you would just let me finish my
20 question, I would appreciate it.
21 MR. PRUSASKI: What was the
22 question?
23 MR. SELZ: I was going to finish
24 the question.
25 Q. Did you have any knowledge as to

□

49

1 Rubenstein
2 why Mr. Joao left or whether or not he was
3 terminated?
4 A. No.
5 Q. Okay. So you have no knowledge,
6 sir, then, of any of the patent applications
7 for IViewIt.com?
8 A. Not at this time, no.
9 Q. How about with regard to any of
10 the trademark or copyright applications?
11 A. No, none whatsoever.
12 Q. Have you ever heard of a company
13 called Zeosync, Z-E-O-S-Y-N-C?
14 A. I am not sure at this time.
15 Q. You are not sure whether or not
16 you have ever heard of it?
17 A. Yeah. Yeah, I don't think I know

Ken Rubenstein Deposition

18 at this time. I am not sure. What do they
19 do?

20 Q. Well, if you don't know what they
21 do and you don't know who they are, then
22 that's your answer.

23 A. All right, that's fine.

24 Q. Who recommended that IViewIt go to
25 Meltzer Lippe for their patent work?

□

50

1 Rubenstein

2 A. I probably suggested it.

3 Q. And was that suggestion
4 communicated in writing?

5 A. Probably not.

6 Q. And, if you can recall, who did
7 you communicate with at IViewIt concerning
8 your recommendation?

9 A. I don't recall.

10 Q. Did you ever meet with Eliot
11 Bernstein?

12 I think you might have said that
13 you never met with him before.

14 A. I don't think I ever met with him.

15 Q. Okay, and you said you don't know
16 who Jude Rosario is; correct?

17 A. Correct.

18 Q. And you don't know who Zackirul
19 Shirajee is; correct?

20 A. Correct.

Ken Rubenstein Deposition

21 Q. How about Jeffrey Friedstein?
22 A. I don't know who he is.
23 Q. Are you aware of whether or not
24 Proskauer Rose accepted any stock from
25 IViewIt?

□

51

1 Rubenstein
2 A. I would have no knowledge of that.
3 Q. Were you ever asked to evaluate
4 for Proskauer Rose the inventions that IViewIt
5 had?
6 A. Not that I recall, no.
7 Q. Did you ever see a video that led
8 you to believe that a company called Visual
9 Data was infringing upon IViewIt?
10 A. I never heard of Visual Data.
11 Q. Are you aware of any of the
12 billings that Proskauer Rose presented to
13 IViewIt for services?
14 A. To my knowledge, I have never seen
15 any such bill.
16 Q. Did you have any discussions with
17 any other partner or associate at Proskauer
18 Rose concerning the billings to IViewIt?
19 A. Not that I could recall.
20 Q. Okay. When I refer to "IViewIt",
21 I mean --
22 A. You mean all of those entities.
23 Q. Correct.

Ken Rubenstein Deposition

24 A. And the answer is, not that I
25 could recall.

□

52

1 Rubenstein

2 Q. Did Mr. Wheeler talk with you at
3 all about any infringement problems or patent
4 rights at IViewIt?

5 A. Not that I recall.

6 Q. And you earlier testified you have
7 never heard of a company called Visual Data;
8 is that correct?

9 A. Not that I can recall at this
10 time.

11 Q. Do you know an individual named
12 Gerald Lewin?

13 A. Gerald Lewin?

14 Q. Yes.

15 A. You mean the former CEO of Time
16 Warner?

17 Q. Yes.

18 A. Well, I know the name, but I don't
19 know him personally.

20 Q. How about Brian Utley?

21 A. Well, I told you already I had a
22 few telephone conversations with him.

23 Q. Other than those telephone
24 conversations, do you know anything of
25 Mr. Utley?

□

1 Rubenstein

2 A. No.

3 Q. How about Gerald Stanley, of
4 Real 3 D?

5 A. I never heard of him and never
6 heard of Real 3 D.

7 Q. You said that earlier.

8 How about Boca Research?

9 A. Never heard of Boca Research.

10 Q. How about Wayne Huizenga Jr. or
11 Sr.?

12 A. Well, I know the name, I don't
13 know them personally.

14 Q. How about Chris Brandon?

15 A. Never heard of him.

16 Q. Robert Henniger?

17 A. Never heard of him.

18 Q. Sportsline?

19 A. Sportsline, S-P-O-R-T-L-I-N-E?

20 Q. Correct.

21 A. I never heard of it.

22 Q. Hollywood.com, I think you
23 testified to earlier.

24 A. You asked me about that, and I
25 answered it already.

□

Ken Rubenstein Deposition
Rubenstein

1

2 Q. Correct.

3 How about Big E?

4 A. I never heard of it.

5 Q. Sensormatic?

6 A. S-E-N-S-O-R-M-A-T-I-C?

7 Q. Right.

8 A. I never heard of it.

9 Q. How about Sensormatics? I'm
10 sorry.

11 A. I don't think I heard of it,
12 either way, to my knowledge right now.

13 Q. How about CrossBow Ventures?

14 A. Well, I only know about it because
15 it was mentioned in some conversation to me
16 prior to this deposition, but I don't have any
17 knowledge of them, never met with them, never
18 had any dealing with them.

19 Q. And what conversation was this,
20 prior --

21 A. In preparation for this
22 deposition.

23 Q. Okay. Do you have any idea who
24 they are?

25 A. I know they are a venture

□

55

1 Rubenstein

2 capitalist, something like that.

3 Q. Are they a client of Proskauer

Ken Rubenstein Deposition

4 Rose?

5 A. I don't know.

6 Q. When Proskauer Rose would
7 represent a new client, would a conflict check
8 be run?

9 A. I think that's the normal
10 procedure of this and most other law firms.

11 Q. When you were contacted or spoke
12 to Mr. Wheeler with regard to IViewIt.com, did
13 you either request that Mr. Wheeler confirm
14 the conflict check had been run or did you
15 conduct one yourself?

16 A. I did not conduct one myself
17 because the client came in through Mr. Wheeler
18 and he -- in the normal procedure, it would be
19 up to him to do the conflict check.

20 Q. Okay, so you relied on the fact
21 that Mr. Wheeler had done one?

22 A. I relied on the fact that it would
23 be the normal procedure in this law firm for
24 him to have done it.

25 Q. But you can't tell me whether or

□

56

1 Rubenstein

2 not today, as you sit here, whether or not one
3 was done.

4 A. I would say it would be the normal
5 procedure in this law firm for it to be done.

6 Q. But do you have any personal

7 knowledge which would indicate to you directly
8 that a conflict check had been run with regard
9 to IViewIt?

10 A. Well, the fact is, in this law
11 firm they would not assign a client billing
12 number to the client without a conflict check
13 being done, and I understand the client
14 billing number was assigned, so that means a
15 conflict check was done --

16 Q. And --

17 A. -- or would normally have been
18 done.

19 Q. Normally, but what I am asking you
20 very specifically is, sir, you do not know for
21 a fact whether or not a conflict check was
22 run?

23 A. Not at this point in time, I do
24 not know.

25 Q. And if there was a conflict found,

□

57

1 Rubenstein
2 what would be the normal procedure?

3 A. It would go to the -- there is a
4 committee that -- in this law firm, that deals
5 with those issues.

6 Q. Does that committees ever obtain
7 waivers of conflicts from clients?

8 A. They might.

9 MR. PRUSASKI: Don't answer the

10 Ken Rubenstein Deposition
question, it's privileged.

11 (DIRECTION NOT TO ANSWER.)

12 Q. Do you maintain any files or any
13 documents concerning IViewIt?

14 MR. PRUSASKI: Him personally?

15 MR. SELZ: In his business records
16 or in his records for Proskauer Rose at
17 the offices in New York.

18 A. Not that I know of, no.

19 Q. Do you know of any patenting of
20 inventions for IViewIt?

21 A. Like I say, I was not involved as
22 their patent counsel, other people served as
23 their patent counsel.

24 Q. Are you aware of any of the
25 particulars of any of those patents?

□

58

1 Rubenstein

2 A. I was not --

3 MR. PRUSASKI: This --

4 A. I will repeat it again, I was not
5 involved as their patent counsel, other people
6 were. And, at this point in time, I have no
7 knowledge of their patent applications.

8 MR. PRUSASKI: Mr. Selz, you are
9 repeating yourself now.

10 MR. SELZ: I'm sorry, Chris.

11 MR. PRUSASKI: Eliot needs to type
12 some new questions.

Ken Rubenstein Deposition
13 A. Maybe he didn't get a good night's
14 sleep.

15 (Pause.)

16 MR. PRUSASKI: Do you have
17 anything else?

18 MR. SELZ: Yes, I do. Just give
19 me a minute. (Pause.)

20 Q. Sir, do you have any knowledge or
21 have you reviewed any of the billing
22 statements that Proskauer Rose provided to
23 IViewIt in this matter?

24 A. No.

25 MR. PRUSASKI: Objection, asked

□

59

1 Rubenstein

2 and answered.

3 Q. Are you aware of any of the
4 services provided by Proskauer Rose to IViewIt
5 in this matter?

6 A. I have no idea.

7 Q. (Pause.)

8 MR. PRUSASKI: Do you have
9 anything else?

10 MR. SELZ: Yes. Just give me a
11 couple of minutes, I am just thinking
12 through this stuff.

13 MR. PRUSASKI: Nothing personal,
14 Mr. Selz, but you are really repeating
15 yourself at this point.

Ken Rubenstein Deposition

16 MR. SELZ: I am trying not to.
17 MR. PRUSASKI: I mean, you asked
18 him twice if he has seen the bills
19 within like three minutes.
20 MR. SELZ: (Pause.)
21 Q. Are you aware of any individuals
22 involved in the MIT Multimedia Lab?
23 A. Personally, no, not at this point.
24 Q. When was the last time you spoke
25 to Brian Utley? You indicated you had a

□

60

1 Rubenstein
2 couple of conversations with him. When was
3 the last discussion held, that you can recall?
4 A. I am not sure.
5 Q. Was it more than a year ago?
6 A. Probably.
7 Q. Do you remember the contents of
8 that conversation at all?
9 A. No. And you asked me that
10 already.
11 Q. I know I did. I am trying to help
12 to refresh your recollection.
13 A. You asked me at least three times
14 that question, so now you are at the point of
15 wasting my time, so I would appreciate it, if
16 you want to ask me some questions, please ask
17 me questions you did not ask me already.
18 Q. Is there anyone else, other than

19 Brian Utley at IViewIt, that you ever had any
20 discussions with?

21 MR. PRUSASKI: You have asked
22 that, about five times.

23 A. You asked me that already.

24 MR. PRUSASKI: And he said no.

25 A. And I answered it already. You

□

61

1 Rubenstein
2 will see the transcript, and you will see the
3 answer.

4 Q. Okay, fine.

5 MR. PRUSASKI: Mr. Selz, is your
6 client sending you questions over the
7 computer?

8 MR. SELZ: No, no, I have got my
9 notes that I have made to ask questions,
10 and I am just trying to correspond
11 Mr. Rubenstein's answers with my
12 questions.

13 MR. PRUSASKI: Are you
14 communicating with him electronically?

15 MR. SELZ: No, I am not.

16 MR. PRUSASKI: Has he been on the
17 phone the whole time?

18 MR. SELZ: Yes.

19 MR. PRUSASKI: He is in
20 San Diego?

21 MR. SELZ: Yes.

22 Ken Rubenstein Deposition
MR. PRUSASKI: Let the record
23 reflect he is taking out time --
24 MR. SELZ: He is sitting in the
25 room next to his wife, waiting for his

□

62

1 Rubenstein
2 wife to go into labor and go into the
3 hospital and --
4 MR. PRUSASKI: And he could have
5 sat in the same room a week-and-a-half
6 ago to have his deposition taken. If he
7 is able to appear at depositions on the
8 telephone, he could have had a
9 deposition taken at his house.
10 MR. SELZ: He can cut out any
11 minute he wants with me, but he can't do
12 it with you, if you have a deposition
13 scheduled.
14 MR. PRUSASKI: We could have
15 accommodated him just fine.
16 MR. SELZ: I am going to put you
17 on hold for a minute.
18 (Pause in proceedings.)
19 MR. SELZ: Okay, Chris, I have
20 been talking to Eliot, he is going to
21 check on his wife, who is in the next
22 room. Let's take a ten-minute break and
23 come right back.
24 MR. PRUSASKI: Okay. I expect you

25 Ken Rubenstein Deposition
both to have some new questions or I

□

63

1 Rubenstein
2 need to go, because we are both very
3 busy.

4 MR. SELZ: I understand, so is
5 everyone.

6 MR. PRUSASKI: So, it's 12:02, we
7 will see you promptly at 12:12 with new
8 questions.

9 Do you want to call us back at
10 this number?

11 MR. SELZ: I will call you back at
12 this number.

13 (Recess taken: 12:04 p.m.-
14 12:16 p.m.)

15 Q. Did you ever receive a letter from
16 Stephen Lamont with regard to IViewIt
17 technology?

18 A. A letter from Stephen Lamont?

19 Q. Yes.

20 A. Not that I know of at this time.

21 Q. Okay.

22 MR. SELZ: Chris, can you give me
23 the fax number there? I will fax you a
24 copy of this letter, for the witness --
25 for the deponent to review.

□

64

Ken Rubenstein Deposition

1 Rubenstein

2 A. I don't know how we are going to
3 orchestrate that.

4 Q. You have got a fax up there?

5 A. We do. We've just got to --

6 MR. PRUSASKI: It's not something
7 that can be delivered immediately?

8 THE WITNESS: Right.

9 MR. SELZ: What I will do is, I
10 will continue with other questions until
11 it's delivered.

12 MR. PRUSASKI: The fax number is
13 969-2900. And you will need to have it
14 delivered to Mr. Rubenstein's office
15 immediately.

16 A. It will probably come out in my
17 E-mail, so we will have to have someone print
18 it out.

19 MR. SELZ: Let me just go and take
20 care of that.

21 Hold on for a moment.

22 (Pause in proceedings: 12:17 p.m.-
23 12:25 p.m.)

24 MR. SELZ: Okay, we are back on.

25 A. Okay.

□

65

1 Rubenstein

2 Q. Okay.

Ken Rubenstein Deposition

3 Now, Mr. Rubenstein, have you
4 looked at any of the billing statements that
5 Proskauer Rose produced to IViewIt in this
6 matter at all?

7 A. Okay, so, number one, you asked me
8 that, I answered it already.

9 Number two, I would like to note,
10 for the record, that we took a break at 12:02,
11 you were supposed to come back at 12:12, you
12 were late, and the first thing you did, upon
13 coming back, was take another break of about
14 nine or ten minutes so you could send me a
15 fax, which could have been sent here in
16 advance. And you are wasting my time by
17 asking me questions that I have already
18 answered.

19 Q. What did you do to prepare for
20 this deposition?

21 A. I met with my attorney.

22 Q. Did you review any documents?

23 A. I reviewed answers to
24 interrogatories briefly that were prepared by
25 Mr. Bernstein.

□

66

1 Rubenstein

2 Q. Did you review any other
3 documents?

4 A. I reviewed a brief segment of
5 Mr. Utley's deposition -- actually, I did not

Ken Rubenstein Deposition

6 review anything from Mr. Utley's deposition,
7 that's a mistake. I may have discussed it
8 with my attorney, but you are getting into
9 privileged information, so I cannot answer it
10 any further.

11 Q. So those are the only things that
12 you reviewed?

13 A. The only thing I looked at was
14 Mr. Bernstein's answers to interrogatories,
15 and I did meet with my attorney.

16 Q. Are you aware, sir, that your name
17 is referenced in billing statements from
18 Proskauer Rose to IViewIt more than a dozen
19 times?

20 A. No, I am not.

21 MR. PRUSASKI: Object to the form.

22 Q. Can you think of any reason, sir,
23 why your name would be mentioned more than a
24 dozen times in billing statements from
25 Proskauer Rose to IViewIt?

□

67

1 Rubenstein

2 A. I had a few conversations with
3 different people about the company over time,
4 as I have testified.

5 Q. And you testified that the
6 conversations took place between you and Chris
7 wheeler and you and Brian Utley.

8 A. Right.

Ken Rubenstein Deposition

9 Q. Correct?
10 A. Possibly -- I don't know if there
11 was anyone else.
12 Q. Do you have any recollection now
13 as to any other conversations?
14 A. No.
15 Q. Now, with regard to E-mails, were
16 you aware of any E-mails that you received
17 from anyone concerning IViewIt?
18 A. I don't know at this point in
19 time.
20 Q. Do you have records of E-mails
21 that you received?
22 A. I would not know at this point in
23 time.
24 Q. Are they normally kept as part of
25 your files?

□

68

1 Rubenstein
2 A. I don't know at this point in
3 time.
4 Q. I had asked you previously, sir,
5 whether or not you had any information on
6 Mr. David Colter.
7 Do you recall that?
8 A. Yes, and I said I wasn't sure who
9 he was, and I suggested you might want to
10 refresh my recollection, and you declined to
11 do so.

Ken Rubenstein Deposition

12 Q. Okay. would it refresh your
13 recollection, sir, if I tell you that
14 Mr. Colter was with Warner Bros.?

15 A. You know, I may have heard the
16 name, but I don't think I ever had any
17 dealings with him, although I am not sure.

18 Q. But you do have dealings with
19 Warner Bros.; is that correct?

20 A. Like I said, Warner Bros. is a
21 client.

22 Q. Right. would there be any reason
23 why your name would be mentioned in E-mails,
24 that you can think of, from Warner Bros. to
25 someone at AOL?

□

69

1 Rubenstein

2 A. I don't know.

3 I mean, I do work -- they are part
4 of the same company, they are clients of the
5 firm, and so, I can't really discuss it
6 because of privilege.

7 Q. Sir, you had indicated earlier you
8 had no idea with regard to any of the
9 intellectual properties or patents for
10 IViewIt; is that correct?

11 A. Not at this point in time.

12 Q. Did you ever issue any opinion to
13 anyone as to the validity of those patents?

14 A. Not that I know of.

Ken Rubenstein Deposition

15 Q. Did you ever provide any
16 information at all with regard to the validity
17 of any of these patents?

18 A. Not that I know of.

19 Q. So it's possible that you have in
20 the past but you don't recall?

21 A. I don't recall having involvement
22 with these patents. I was not the patent
23 counsel.

24 Q. Now, sir, we have faxed you a copy
25 of a letter. I don't know if you have

□

70

1 Rubenstein
2 received it.

3 A. We don't have it yet.

4 Q. Okay, could you find out if that's
5 available?

6 A. All right. We will put you on
7 hold.

8 Q. Thank you.

9 (Pause in proceedings.)

10 Q. Okay, are you with me?

11 A. Yes.

12 Q. Do you have the fax?

13 A. No, I do not. Like I say, you
14 should have sent it up here yesterday or in
15 advance.

16 Q. That's fine, that's fine. I was
17 expecting that maybe you would have a better

Ken Rubenstein Deposition

18 recollection of some of these events, and
19 maybe that was my incorrect presumption,
20 considering that I guess the communication
21 from Stephen Lamont occurred relatively
22 recently --

23 A. Well, when did it occur?

24 Q. Well, that's what I was going to
25 ask you, first of all, if you can recall.

□

71

1 Rubenstein

2 A. Well, you asked me about that, and
3 I told you I may have spoken to him once, but
4 I don't recall the details right now.

5 Q. Now, with regard to what we talked
6 about earlier was the conflict of interest and
7 whether or not Proskauer Rose's position in
8 representing IViewIt constituted a conflict
9 with other clients, I think you mentioned that
10 you expected Mr. Wheeler to do the conflict
11 check; is that correct?

12 A. Yes.

13 Q. Are you aware of any conflict of
14 interest between IViewIt and any of your own
15 clients?

16 A. No.

17 MR. PRUSASKI: What's the
18 relevancy of that, Mr. Selz?

19 MR. SELZ: I think it goes to
20 whether or not IViewIt should have been

Ken Rubenstein Deposition

21 represented by Proskauer Rose in the
22 first place.

23 MR. PRUSASKI: Oh, is that a new
24 theory that you haven't pled?

25 MR. SELZ: Is that an objection?

□

72

1 Rubenstein

2 MR. PRUSASKI: Yes, it's objection
3 to relevance.

4 MR. SELZ: Okay, so noted for the
5 record.

6 Q. Mr. Rubenstein, you had indicated
7 that you are not aware of any conflicts
8 between IViewIt and any of your other clients;
9 is that correct?

10 A. Not at this point in time, no.

11 Q. Were you aware of any conflicts in
12 the past?

13 A. Not that I know of.

14 Q. Would there be any records kept of
15 any conflict check that was run by Mr. Wheeler
16 or any other --

17 A. I don't know.

18 Q. Would you let me finish my
19 question, please.

20 -- Mr. Wheeler or any other
21 partner or associate of your firm.

22 A. I don't know what records there
23 might be.

Ken Rubenstein Deposition

24 Q. You indicated there was a conflict
25 committee. Does that conflict committee meet

□

73

1 Rubenstein
2 in New York or do they meet in Florida or is
3 there any particular location for their
4 meetings?

5 MR. PRUSASKI: Objection,
6 relevance.

7 You can answer this question, but
8 it's not going to get much further.

9 A. I assume they meet in New York.

10 Q. Is there any particular reason for
11 that assumption?

12 A. Most of the law firm is in
13 New York.

14 Q. Sir, I am a little confused about
15 some of your earlier testimony. I had asked
16 you whether or not you had spoken with any of
17 your clients concerning IViewIt and its
18 technology, and your response was to claim
19 privilege. Is that still the case, you are
20 claiming privilege with regard to any of those
21 communications?

22 MR. PRUSASKI: Yes.

23 A. Yes.

24 Q. Okay. I am going to just say at
25 this point that you testified that there were

1 Rubenstein
2 only two occasions that you had spoken with
3 third parties Mr. Utley and Mr. Wheeler that
4 you can recall with regard to IViewIt; is that
5 correct?

6 MR. PRUSASKI: I don't recall that
7 being his testimony.

8 A. That's not my testimony.

9 Q. What was your testimony?

10 A. We will have to have it read
11 back. I don't remember exactly what I said --

12 Q. Okay.

13 A. -- in response to which particular
14 question right now.

15 Q. Well, let me pose a new question,
16 sir, and I think I have asked you this before,
17 and I am going to pose it again because I am
18 unclear now.

19 You have communicated with third
20 parties with regard to IViewIt; is that
21 correct?

22 A. Well, what do you mean by "third
23 parties"?

24 Q. People or entities other than
25 IViewIt.

Ken Rubenstein Deposition
Rubenstein

1

2 A. Uh -- I might have, I might not
3 have, I am not sure right now.

4 Q. And those third parties you are
5 saying are clients of yours, is that why you
6 are asserting a privilege?

7 A. well, it depends who you mean by a
8 "third party". You know, "third party" is a
9 vague term.

10 why don't you name some particular
11 third parties and I will answer the question,
12 if I have haven't answered it already.

13 Q. I think you said that you were
14 asserting a privilege with regard to Warner
15 Bros., I think you said --

16 A. well, Warner Bros. is a client
17 here.

18 Q. Right. And Sony.

19 A. Sony is a client here.

20 Q. Right. So you refuse to answer
21 whether or not you had communicated to those
22 parties with regard to IViewIt; is that
23 correct?

24 A. Correct, or anything else I might
25 have communicated to them.

□

76

1 Rubenstein

2 Q. well, I am not asking you about
3 anything else, because, really, frankly, sir,

4 that's not only not relevant but, clearly,
5 that would be privileged, but I am asking you
6 with regard to simply IViewIt --

7 A. Well, you know, that's our
8 position, our position is that any
9 conversation with those entities is
10 privileged.

11 Q. Okay, and if there was a
12 discussion -- are you saying there was no
13 discussion or are you saying there was a
14 discussion that was privileged?

15 A. I am not saying there was a
16 discussion, I am not saying there was not a
17 discussion, I am saying it's privileged.

18 Q. So you can't simply answer no,
19 there was no discussion --

20 A. I am not saying there was, I am
21 not saying there was not, I am saying it's
22 privileged.

23 MR. SELZ: I am going to certify
24 that question, we will take it up with
25 Judge Labarga and see what his

□

77

1 Rubenstein
2 determination is about that.

3 (RULING SOUGHT.)

4 Q. Now, with regard to any other
5 issues concerning IViewIt.com or any IViewIt
6 entities, have you had any communications

7 since the filing of this lawsuit with anyone
8 concerning IViewIt?

9 A. Well, I don't know when the
10 lawsuit was filed.

11 Q. Since 2001, have you had any
12 communications with anyone concerning IViewIt
13 Technologies or any of the IViewIt entities?

14 A. Not that I recall at this time.

15 Q. Have you spoken to Ray Joao with
16 regard to it?

17 MR. PRUSASKI: Asked and
18 answered.

19 A. You asked me about Ray Joao
20 already.

21 Q. Since 2001.

22 A. Not that I know of at this time.

23 Q. Sir, have you ever been involved
24 in setting up corporations for clients?

25 A. No.

□

78

1 Rubenstein

2 Q. Have you ever made any
3 representations to any company or any entity
4 with regard to the advisability of setting up
5 corporations for them?

6 A. Not that I know of.

7 Q. Who would you refer that to at
8 Proskauer Rose if there was --

9 A. I am not sure, it would depend on

10 the particular situation.
11 Q. Do you have any idea what
12 Mr. Wheeler's specialization is?
13 A. No.
14 Q. Have you ever spoken with him with
15 regard to the legal services he was providing
16 to IViewIt?
17 A. You asked me that --
18 MR. PRUSASKI: Asked and
19 answered.
20 A. -- already and I answered it.
21 Q. And what was your answer again,
22 sir, "No"?
23 A. I don't remember the exact
24 question you asked, so I don't remember the
25 exact wording of my answer, what the question

□

79

1 Rubenstein
2 was -- but the question was asked and
3 answered.
4 Q. Do you have that fax yet?
5 A. No. We will call my secretary
6 again.
7 I will put you on hold.
8 Q. Okay.
9 (Pause in proceedings.)
10 A. Okay, the fax is coming, so we are
11 just going to put you on hold for a minute.
12 Q. Thank you?

13 Ken Rubenstein Deposition
(Pause in proceedings: 12:35 p.m.-
14 12:41 p.m.)
15 A. All right. We have your letter.
16 Q. Do you ever recall seeing this
17 letter?
18 MR. SELZ: Let's get it marked,
19 first of all, by the court reporter as
20 Defendants' 1.
21 A. The letter is dated today, and I
22 never saw it before.
23 Q. Have you ever seen the contents of
24 this letter?
25 A. No. I haven't read the letter

□

80

1 Rubenstein
2 yet.
3 Q. Okay.
4 A. I note that the letter is two-plus
5 pages long, I haven't read it. The letter is
6 dated today, November 20, 2002, and it's
7 unsigned, so this is a letter you guys,
8 IViewIt, created today.
9 Q. Well, I think that's a presumption
10 that you are putting into the record, sir.
11 A. Well, the letter I have in front
12 of me is dated today.
13 Q. Let me go ahead.
14 First of all, let's get it marked
15 as Number 1, Defendants' 1.

Ken Rubenstein Deposition

16 MR. PRUSASKI: Objection to the
17 predicate, he has never seen it before.
18 MR. SELZ: Let me ask him a
19 question about it first. I haven't even
20 examined him on it. Let me -- Chris,
21 this is my deposition of him, and I
22 appreciate the fact that he wants to get
23 this over, but that isn't an excuse for
24 him to jump the gun.
25 MR. PRUSASKI: I have a right to

□

81

1 Rubenstein
2 make objections as I see fit, and I am
3 not taking instructions out of practice
4 law from you.
5 MR. SELZ: That's fine. I am just
6 saying, let me get it marked first.
7 (Deposition Exhibit Defendants' 1,
8 letter dated, November 20, 2002, with
9 fax transmittal cover sheet, was marked
10 for identification, as of this date.)
11 Q. Mr. Rubenstein, do you have in
12 front of you what's been marked as Defendants'
13 Number 1? Is that correct?
14 A. Yes.
15 Q. Okay, could you please read it for
16 me?
17 MR. PRUSASKI: Out loud?
18 Q. No, to yourself.

19 A. well, I will scan it, but I want
20 to note it's a two-page letter, I have not had
21 an opportunity to study it. So if you ask me
22 questions about the letter, I am going to tell
23 you I have not had an opportunity to study it.
24 Q. Okay, then I will go through the
25 letter paragraph by paragraph with you to see

□

82

1 Rubenstein
2 if you recall any of it.

3 Do you ever recall receiving a
4 correspondence from Stephen Lamont?

5 A. Like I say, I haven't had a chance
6 to study your letter.

7 Q. I am not talking about this
8 particular --

9 A. I don't recall any correspondence
10 from Stephen Lamont at this point in time.

11 Q. Do you ever recall a request by
12 Wayne Smith of Warner Bros. as to IViewIt's
13 pending patents?

14 A. No. It might be that somebody at
15 IViewIt asked me to talk to Warner Bros. and I
16 declined. That might be the fact.

17 Q. Are you aware of any
18 confidentiality agreement executed by Warner
19 Bros. with regard to IViewIt?

20 A. No.

21 Q. Have you ever seen any such

22 agreement?

23 A. Not that I could recall.

24 Q. Again, sir, this letter refers to
25 you being on the advisory board of IViewIt

□

83

1 Rubenstein

2 between fall of 1999/spring of 2000.

3 A. I was never on any advisory board
4 of IViewIt.

5 Q. Did Stephen Lamont ever meet with
6 you in person?

7 A. I think I -- as I testified, I may
8 have had a conversation with him, I don't know
9 if it was in person or not.

10 Q. You previously testified that you
11 had never reviewed any of IViewIt's
12 technologies; is that correct?

13 A. I never testified to that. What I
14 told you is, I don't have any knowledge of it
15 right now.

16 Q. Okay.

17 A. I don't know whether I reviewed it
18 or not.

19 Q. So it's possible, then, sir, that
20 you did review it.

21 A. Like I said, I answered the
22 question. You asked me, I answered it. I
23 don't know whether I reviewed it or not. I
24 have no knowledge of it right now. I was not

Ken Rubenstein Deposition
25 their patent attorney, I was not involved with

□

84

1 Rubenstein

2 their patents.

3 Q. Okay, if you don't have a
4 recollection of reviewing it, but then it's
5 possible that you had; is that correct?

6 MR. PRUSASKI: Anything's
7 possible. I think we could stipulate to
8 that.

9 A. Right, I don't think it's possible
10 but -- and I don't think it happened.

11 Q. Do you have any clearer
12 recollection of it because of this letter?

13 A. No, I don't have a detailed
14 recollection or any recollection of it at this
15 point in time.

16 Q. And, again, I think you had
17 testified that you don't know anyone -- Greg
18 Thagard, you don't know Greg Thagard?

19 A. I do know Greg Thagard.

20 Q. Who is Greg Thagard?

21 A. He used to work at Warner Bros.

22 Q. Does Mr. Thagard, to the best of
23 your knowledge, have any information
24 concerning IViewIt?

25 A. I don't know at this point in

□

85

Ken Rubenstein Deposition

1 Rubenstein

2 time.

3 Q. What, to the best of your
4 recollection, was Greg Thagard's role with
5 regard to IViewIt?

6 A. I don't know what he might or
7 might not have done with respect to IViewIt.

8 Q. Who is Greg Thagard?

9 A. He is a person who worked at
10 Warner Bros.

11 Q. Well, what was his position --

12 A. He was in technical -- in the
13 technology side of the company.

14 Q. Do you have any idea where
15 Mr. Thagard is currently?

16 A. No. I believe he left the
17 company.

18 Q. How about Chris Cookson, did you
19 ever have any conversations with Chris Cookson
20 concerning IViewIt Technologies?

21 A. Like I say, Chris Cookson works
22 for Warner Bros., and any conversations I had
23 with Warner Bros. are privileged. So, I am
24 not saying I had a conversation, I am not
25 saying I did not have a conversation, I am

□

86

1 Rubenstein

2 saying you are asking for privileged material.

Ken Rubenstein Deposition

3 Q. And David Colter?

4 A. I am not sure I ever had any
5 dealings with him.

6 Q. And who is David Colter?

7 A. You asked and I answered that
8 question already.

9 Q. So you have never seen this
10 correspondence, you don't recall seeing this
11 correspondence from Mr. Lamont; is that
12 correct?

13 MR. PRUSASKI: It's dated today.

14 A. It's dated today.

15 MR. PRUSASKI: It's marked
16 "Draft". It's impossible for us to
17 have seen it before. And the return
18 address is an empty house in Los Angeles
19 County.

20 Q. Have you ever seen the contents of
21 this letter before?

22 A. I have never --

23 MR. PRUSASKI: He answered these
24 questions, no?

25 A. I have never seen the letter

□

87

1 Rubenstein

2 before.

3 Q. How about the E-mails that were
4 faxed over to you, as well? There is an
5 E-mail that's dated August 6, 2001. Have you

Ken Rubenstein Deposition

6 ever seen that E-mail before?

7 A. Is this an E-mail from David
8 Colter to Heidi Krauel?

9 Q. Correct.

10 MR. PRUSASKI: The one dated
11 August 1, 2001?

12 MR. SELZ: Correct.

13 A. Right, I see the E-mail.

14 Q. Okay.

15 MR. SELZ: Let's get it marked as
16 2.

17 (Deposition Exhibit Defendants' 2,
18 fax transmittal cover sheet and E-mails,
19 was marked for identification, as of
20 this date.)

21 Q. Sir, do you have any reason to
22 know why your name is mentioned in that
23 E-mail?

24 A. No, because I don't recall giving
25 any opinions about the patents.

□

88

1 Rubenstein

2 Q. And you never, to the best of your
3 recollection, had any discussions with
4 Mr. Thagard with regard to same, either?

5 A. Like I say, any discussion I might
6 have or might not have had with Mr. Thagard
7 would be privileged.

8 Q. I am going to put you on hold for
Page 79

Ken Rubenstein Deposition

9 just a minute.

10 (Pause.)

11 MR. SELZ: Okay, we are back on.

12 Okay, I have got nothing further
13 at this time. However, we are going to
14 have to go to Judge Labarga with regard
15 to your refusal to answer on some of
16 these issues with your claim of
17 privilege, so we may have to come back
18 and conclude with those questions at a
19 later date.

20 MR. PRUSASKI: Fine.

21 THE WITNESS: We will take it
22 under advisement.

23 We are not committing to come back
24 or not.

25 MR. SELZ: That's fine.

□

89

1

2 (Time noted: 12:48 p.m.)

3

4

5

KENNETH RUBENSTEIN

7

8 subscribed and affirmed

9 before me this ____ day

10 of _____, 2002.

11 _____

Ken Rubenstein Deposition

12
13
14
15
16
17
18
19
20
21
22
23
24
25

□

90

1
2
3
4
5
6
7
8
9
10
11
12
13
14

C E R T I F I C A T E

STATE OF NEW YORK)
 : ss.
COUNTY OF NEW YORK)

I, WENDY D. BOSKIND, a Registered
Professional Reporter and Notary Public
within and for the State of New York,
do hereby certify:

That KENNETH RUBENSTEIN, the
witness whose deposition is hereinbefore
set forth, affirmed before me, and
that such deposition is a true and
accurate record of the testimony given

Ken Rubenstein Deposition

15 by the witness.

16 I further certify that I am not
17 related to any of the parties to this
18 action by blood or marriage, and that
19 I am in no way interested in the
20 outcome of this matter.

21 IN WITNESS WHEREOF, I have
22 hereunto set my hand this 26th day
23 of November, 2002.

24
25 _____
WENDY D. BOSKIND, RPR

□

1

2 November 20, 2002

3 I N D E X

4 WITNESS	EXAMINATION BY	PAGE
5 Kenneth Rubenstein	Mr. Selz	4

6

7 ----- EXHIBITS-----

8 Defendants' 1, letter dated, November 20,		
9 2002, with fax transmittal cover sheet.....		81
10 Defendants' 2, fax transmittal cover		
11 sheet and E-mails.....		87

12

13

14 (DIRECTION NOT TO ANSWER.).....		25
15 (DIRECTION NOT TO ANSWER.).....		28
16 (DIRECTION NOT TO ANSWER.).....		30
17 (DIRECTION NOT TO ANSWER.).....		41

Ken Rubenstein Deposition

18 (DIRECTION NOT TO ANSWER.)..... 47
19 (DIRECTION NOT TO ANSWER.)..... 57
20
21 (MOTION TO STRIKE.) 10
22
23 (RULING SOUGHT.)..... 77
24
25

□

1
2 STATE OF NEW YORK) Pg__of__Pgs
3 ss:
4 COUNTY OF NEW YORK)
5 I wish to make the following changes,
6 for the following reasons:
7 PAGE LINE
8 ____ ____ CHANGE: _____
9 REASON: _____
10 ____ ____ CHANGE: _____
11 REASON: _____
12 ____ ____ CHANGE: _____
13 REASON: _____
14 ____ ____ CHANGE: _____
15 REASON: _____
16 ____ ____ CHANGE: _____
17 REASON: _____
18 ____ ____ CHANGE: _____
19 REASON: _____
20 ____ ____ CHANGE: _____

Ken Rubenstein Deposition

21 REASON: _____
22 _____ CHANGE: _____
23 REASON: _____
24 _____ CHANGE: _____
25 REASON: _____

□



EXHIBIT D²⁴

²⁴ The Company does not validate the following documents as true copies of originals and seeks to obtain said originals and all backup logs of any data submitted by Respondent, as the Company has reason to believe that, while useful for illustration in this rebuttal, these documents bear semblance of fraud and deceit on the part of Respondent.



RESPONDENT RECEIVES PROPRIETARY AND CONFIDENTIAL CD

IVIEWIT.Com LLC

Matter: Misc. Intellectual Property Matters
Client Number 05865-00020

<u>Date</u>	<u>Description</u>	<u>Time</u>	<u>Value</u>
Raymond A. Joao			
03/29/99	Conferences with Eliot Bernstein re: follow-up work re: Provisional Patent Application.	0.80 Hrs	\$240.00
04/05/99	Conference with Eliot Bernstein re: follow-up work re: Provisional Patent Application.	1.40 Hrs	\$420.00
04/07/99	Reviewed IVIEWIT CD ROM to identify intellectual property and related issues.	1.00 Hrs	\$300.00
04/22/99	Conference with E. Bernstein and Chris Wheeler re: scope of patent protection.	0.70 Hrs	\$210.00
05/11/99	Conference with E. Bernstein.	0.40 Hrs	\$120.00
05/12/99	Conference with J. Lewin and E. Bernstein; reviewed Non-Disclosure agreement and conferences with C. Wheeler of Proskauer Rose et al re non-disclosure agreement.	1.40 Hrs	\$420.00
06/01/99	Conference with IVIEWIT group and Proskauer; reviewed patent application and draft of new invention.	1.60 Hrs	\$480.00
06/02/99	Conference with E. Bernstein re: new invention and reviewed disclosure.	1.00 Hrs	\$300.00
06/04/99	Reviewed non-disclosure agreement and conference with Chris Wheeler; attended to plans for trip to Florida to meet with E. Bernstein & C. Wheeler.	1.60 Hrs	\$480.00
06/09/99	Prepared for trip to IVIEWIT, conference call with Proskauer & IVIEWIT.	1.20 Hrs	\$360.00
06/11/99	Conference call with Chris Wheeler of Proskauer re: scope of patent coverage.	0.10 Hrs	\$30.00
06/14/99	Conferences with E. Bernstein & C. Wheeler.	0.50 Hrs	\$150.00
06/15/99	Conference with C. Wheeler re: patent protection.	0.10 Hrs	\$30.00
06/16/99	Travel to Boca Raton, conference with S. Bernstein, E. Bernstein & C. Wheeler at Proskauer.	8.00 Hrs	\$2,400.00
06/17/99	Conference with E. Bernstein re: I.P. strategies and pending patent applications. Conference at Proskauer with prospective investor.	8.00 Hrs	\$2,400.00
06/18/99	Conference with E. Bernstein & C. Wheeler re: pending patent applications; conference with E. Bernstein re: patent strategies.	5.50 Hrs	\$1,650.00
06/21/99	Return trip to New York from Boca Raton.	6.00 Hrs	\$1,800.00
06/30/99	Drafted patent application.	2.50 Hrs	\$750.00
06/30/99	Conferences with E. Bernstein and reviewed business plan.	0.40 Hrs	\$120.00
ATTORNEY TOTAL		42.20 HRS	\$12,660.00



RESPONDENT THROUGH MR. RUBENSTEIN RECEIVES PROCESSES

-----Original Message-----

From: Eliot Bernstein [mailto:alps@netline.net]
Sent: Tuesday, February 23, 1999 7:53 AM
To: Kenneth Rubenstein (E-mail); Christopher C. Wheeler (E-mail)
Subject: Please call when you receive this message. 800.519.0234 or
561.417.8980

Ken,

Per our discussion, I have attached the following file = process.doc.

Eliot

<< File: ATT00027.html >> << File: PROCESS.doc >>



RESPONDENT RECEIVES COMPANY BUSINESS PLAN

IVIEWIT.Com LLC

Matter: Misc. Intellectual Property Matters
Client Number 05865-00020

<u>Date</u>	<u>Description</u>	<u>Time</u>	<u>Value</u>
Raymond A. Joao			
03/29/99	Conferences with Eliot Bernstein re: follow-up work re: Provisional Patent Application.	0.80 Hrs	\$240.00
04/05/99	Conference with Eliot Bernstein re: follow-up work re: Provisional Patent Application.	1.40 Hrs	\$420.00
04/07/99	Reviewed IVIEWIT CD ROM to identify intellectual property and related issues.	1.00 Hrs	\$300.00
04/22/99	Conference with E. Bernstein and Chris Wheeler re: scope of patent protection.	0.70 Hrs	\$210.00
05/11/99	Conference with E. Bernstein.	0.40 Hrs	\$120.00
05/12/99	Conference with J. Lewin and E. Bernstein; reviewed Non-Disclosure agreement and conferences with C. Wheeler of Proskauer Rose et al re non-disclosure agreement.	1.40 Hrs	\$420.00
06/01/99	Conference with IVIEWIT group and Proskauer; reviewed patent application and draft of new invention.	1.60 Hrs	\$480.00
06/02/99	Conference with E. Bernstein re: new invention and reviewed disclosure.	1.00 Hrs	\$300.00
06/04/99	Reviewed non-disclosure agreement and conference with Chris Wheeler; attended to plans for trip to Florida to meet with E. Bernstein & C. Wheeler.	1.60 Hrs	\$480.00
06/09/99	Prepared for trip to IVIEWIT, conference call with Proskauer & IVIEWIT.	1.20 Hrs	\$360.00
06/11/99	Conference call with Chris Wheeler of Proskauer re: scope of patent coverage.	0.10 Hrs	\$30.00
06/14/99	Conferences with E. Bernstein & C. Wheeler.	0.50 Hrs	\$150.00
06/15/99	Conference with C. Wheeler re: patent protection.	0.10 Hrs	\$30.00
06/16/99	Travel to Boca Raton, conference with S. Bernstein, E. Bernstein & C. Wheeler at Proskauer.	8.00 Hrs	\$2,400.00
06/17/99	Conference with E. Bernstein re: I.P. strategies and pending patent applications. Conference at Proskauer with prospective investor.	8.00 Hrs	\$2,400.00
06/18/99	Conference with E. Bernstein & C. Wheeler re: pending patent applications; conference with E. Bernstein re: patent strategies.	5.50 Hrs	\$1,650.00
06/21/99	Return trip to New York from Boca Raton.	6.00 Hrs	\$1,800.00
06/30/99	Drafted patent application.	2.50 Hrs	\$750.00
06/30/99	Conferences with E. Bernstein and reviewed business plan.	0.40 Hrs	\$120.00
ATTORNEY TOTAL		42.20 HRS	\$12,660.00

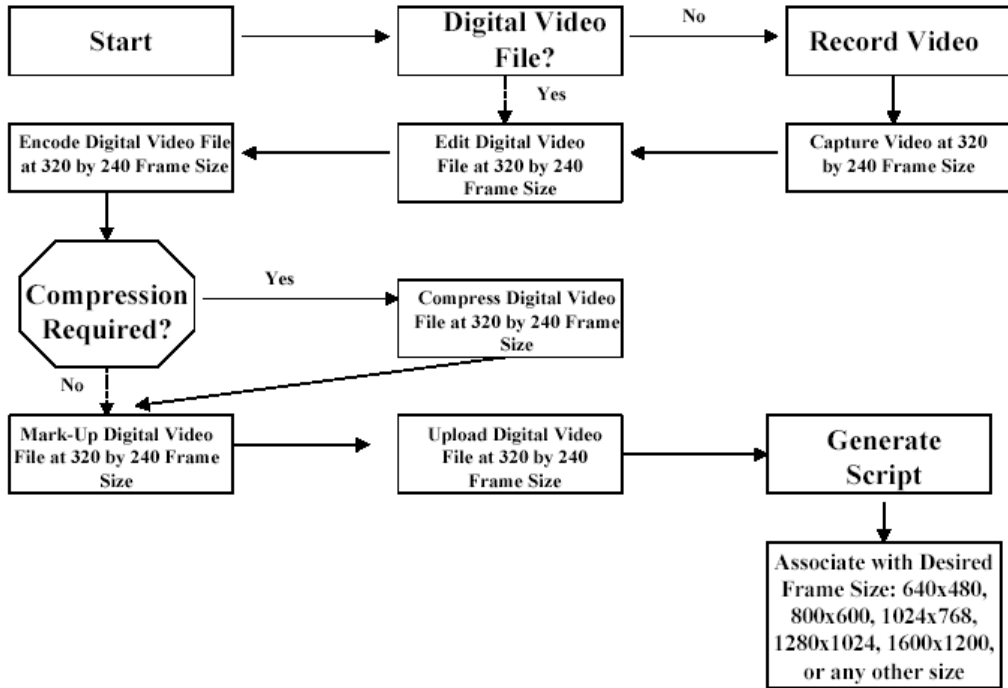

EXHIBIT E



COMPANY VIDEO TECHNOLOGY SPECIFICATION

VIDEO TECHNOLOGY





VIDEO DISCLOSURE BY PROSKAUER²⁵

PROSKAUER ROSE LLP

2256 Circle Road
Suite 340 West
Boca Raton, FL 33431-7380
Telephone 561.241.7400
Fax 561.241.7400
432.7748
561.241.7145

NEW YORK
LOS ANGELES
WASHINGTON DC
CHICAGO
PHILADELPHIA

PERSONAL AND CONFIDENTIAL

Fax Transmittal

Date June 1, 1999 Client-Matter 0894/40017/001
Total Pages (including Cover) 2
From Christopher C. Wheeler
Sender's Voice Number 561.995.4702

Sender's Room Number
Main Fax Operator 561.241.7400

To Ray Joao
Company Meltzer, Lippe

Fax No. 516.747.9363
Voice No. 516.747.0300.x240

Message

The attached is from Eliot Bernstein.

EB
561-417-4470

2025
B.W.I
35.60

Confidentiality Note: This message is confidential and intended only for the use of the addressee(s) named above. It may contain legally privileged material. Dissemination, distribution or copying of this message, other than by such addressee(s), is strictly prohibited. If you have received this message in error, please immediately notify us by telephone and return the original to us at the address above. We will reimburse you for the cost of the telephone call and postage. Thank you.
0894/40017-001 08/01/99 01:07 PM (2743)

²⁵ As the Company does not endorse that this is a true copy of this document received from Proskauer, the Company requests First Judicial Department Departmental Disciplinary Committee to obtain the original tape from the records of Proskauer.



PATENT FOR VIDEO TECHNOLOGY

- > Step 1. Is to record the video under any format, beta, VHS, digital, any of the standard file formats. *VHS camera, film camera, digital - or cell, live broadcast.*
- > Step 2. After the video is shot, the second step is to capture the video using any capture device and capture software. *Adobe Premier ~~5.1~~ VERSION 5.1 or Real Ruler. 5.2*
- > Step 3. Is to edit the video, if necessary, using any standard video editing tools. *Adobe Premier 5.1*
- > Step 4. Is to convert to real video format. *Real Ruler*
- > Step 5. Then we manually set the size of the video within the HTML code to 640 by 480. *Adobe Premier*
- > Step 6. We then post to the Web using any Web FTP software. *WS FTP 4.00*
- > Step 7. We then write an Ascii file that calls the real video to stream. This makes it a streaming real at full screen with very good clarity and quality. Under Step 7 we write a separate script saved as our *.rm (star.rm) file that will call the original real video file. This script is included in the HTML codes. For MPEG videos, we follow Steps 1 through 3 the same, then we, in Step 4, convert, if not already, to the MPEG format. 5, insert the video in the HTML codes and expand to 640 by 480. Then we upload the video file to the Web in Step 6. Step 7, this MPEG file is played from the Web by first downloading a small portion of the file and played through the necessary player or any player, actually, that supports AVI, MPEG-type video formats.

This tape was recorded on 6/1/99 at the law firm of Proskauer Rose LLP.



PROVISIONAL FILING

Attorney Docket No. 5865-3

APPARATUS AND METHOD FOR PRODUCING ENHANCED VIDEO IMAGES

The present invention is directed to an apparatus and a method for producing enhanced video images. A preferred embodiment of the invention is described in the following manner.

- Step 1. Record the video under any format, i.e., beta, VHS, digital, and/or any of the standard file formats, including, but not limited to, *.AVI, *.MOV, *.MPEG, etc., by utilizing an appropriate recording device such as a video camera, a film camera, a reel-to-reel recording device, and/or a live video recording device.
- Step 2. After the video is shot, the second step is to capture the video using any capture device such as a capture card or capture hardware, such as provided by Dazzle, and also by using capture software such as Adobe Premier version 5.1 or Real Producer G2.
- Step 3. Edit the video, if necessary, by using any standard video editing tools, such as, for example, Adobe Premier 5.1.
- Step 4. Convert the data and/or information obtained to a real video format such as, but not limited to, a *.RM format.
- Step 5. Manually set the size of the video within the HTML code to a 640 x 480 frame resolution, or any other suitable resolution, such as, but not limited to, 800 x 600, 1024 x 768, 1280 x 1024, 1600 x 1200.
- Step 6. Post the obtained file to a Web page, Web site and/or to the Web, by using any Web FTP software, such as, but not limited to, WS FTP PRO.
- Step 7. Generate or write an ASCII file that calls the real video to stream. This results in streaming real video at full screen with very good clarity and quality. Under Step 7 a separate ASCII file is written and saved as an *.RPM file, or other suitable format, that will call the original real video file. This script is included in the HTML codes. For MPEG videos, Steps 1 through 3 are followed as described above. In Step 4, the file is converted, if not previously converted, to an MPEG format. Next, the video is inserted into the HTML codes and expanded to a 640 by 480 resolution, or higher resolution. Then the video file is uploaded to the Web page Web site, and/or the Web in Step 6. Thereafter, at Step 7, the MPEG file is played from the Web page, Web site and/or from the Web, by first downloading a small portion of the file and playing the file through a suitable player which supports AVI, MPEG-type, etc., video formats and/or other suitable formats.

P:\PUBLIC\PATENT\BERNSTEIN\5865-3.APP



TRANSCRIPTION OF TELECONFERENCE CONDUCTED JULY 31, 2000²⁶

Transcription of Telephone Conference
Conducted July 31, 2000

Participants:

Simon Bernstein, Eliot Bernstein, Maurice Buchsbaum,
Brian Utley, Doug Boehm, Chris Wheeler

Utley: <begins midstream>...status of the original digital image filings, and basically the fact that the original filings do not cover the full subject matter of the imaging technology; and to wit, one of the omissions, in particular in reading the claims section of the provisional and the formal filing, relates to the zooming and panning capability that is inherent in the technology. This has become a topic due to the fact that we are currently in the second phase of filing imaging patent protection which is driven by the provisionals that were filed later last year, between August and December of last year. So the concern that were expressed by Eliot in reviewing this is that this omission of the zooming and panning capability was attributable to a failure, for whatever reason, on the part of Ray Joao, the patent attorney of record, in constructing and putting together the provisional and formal filing<tape cuts out here> did I say it is that right Eliot

E Bernstein I believe so

²⁶Supra note 20 at 1-2.

CORRECTED VERSION - CORRECTED ON 5/14/2003
Transcription of Telephone Conference
Conducted July 31, 2000

Participants:

Simon Bernstein, Eliot Bernstein, Maurice Buchsbaum,
Brian Utley, Doug Boehm, Chris Wheeler

Note: Square brackets [] are used to indicate inaudible or indecipherable text. Text found inside brackets indicates transcriptionist's best guess. Since speaker names are not specifically identified, transcriptionist has made an attempt to identify based upon comments made in conversation but cannot guarantee that each speaker has been accurately identified. Note also that this recording has numerous instances of participants speaking at once or carrying on simultaneous side conversations that make it difficult to follow and transcribe the entire line of discussion.

Utley: <begins midstream>...status of the original digital image filings, and basically the fact that the original filings do not cover the full subject matter of the imaging technology; and to wit, one of the omissions, in particular in reading the claims section of the provisional and the formal filing, relates to the zooming and panning capability that is inherent in the technology. This has become a topic due to the fact that we are currently in the second phase of filing imaging patent protection which is driven by the provisionals that were filed later last year, between August and December of last year. So the concern that were expressed by Eliot in reviewing this is that this omission of the zooming and panning capability was attributable to a failure, for whatever reason, on the part of Ray Joao, the patent attorney of record, in constructing and putting together the provisional and formal filing<tape cuts out here> did I say it is that right Eliot

E Bernstein I believe so

Utley Is that your understanding

E Bernstein Correct

Utley The purpose of this meeting is to review the facts and I think there are two particular points that are ...that are important to moving ahead. The first is: "Given that the filings are what they are, and given what we know about the filing which is scheduled to take place this week on Wednesday, what means do we have to correct the situation; and given whatever corrections we find, what then is the impact or exposure to iviewit based upon what actions we can take. Then, lastly, what, if any, recourse might iviewit have vi sa vi the omissions in the original filings Are there any other issues, Doug?

Bernstein: Yeah, just correcting back to Ray Joao's work of the formal filing that he filed. Do we have a copy of that?

Utley: I do have that.

Bernstein: I don't. I've got the provisional and I've got...

Boehm: Everything is on the table

Utley: you should have...the formal.

Bernstein: This one?

Utley: Yes, that's the formal.

Bernstein: Okay.

Simon Bernstein: I just have one question. Does anybody have, or are we allowed to get, the files of Ray Joao?

Boehm: I have them.

Wheeler: Do you have all of the work that he had?

Bernstein: No, not all of it.

Utley: What was purported to be in the files?

Bernstein: And he also claimed to us that he destroyed part of his files.

Boehm: And I have some of his files. I have what was purported to be all of the firms' files.

<Inaudible comment.>

Utley: Well, there's a whole history, then, because I tried to get complete copies of the files originally, and found out later that not only did he not send us all the files, he didn't even mention that there was an extra filing out there that we didn't even know about.

Bernstein: This one that's in question.

Boehm: Yep

Simon Bernstein: You have no notes, no data on...?

Boehm: No, I have the application. I have things that you could get from the US patent office—that I could get from the US patent office. I have very few notes. I do have some scribbled Ray Joao's notes, but I think you gave me those notes.

Utley: I did. I gave you Bill Dick after Bill yourself[] the notes that I had.

Bernstein: And Ray's made disclosures to us that he destroyed the documents to protect us, which I don't know what he was thinking.

Simon Bernstein: Destroyed what documents?

Bernstein: Whatever he had in his files. Other patent copies, copies of the drafts as they proceeded...all that he destroyed to protect us from something I asked him to explain, and his reasoning...because I said to him, you know, usually you destroy documents when you are protecting somebody from something illegal or something. Have I done something that would force you to hurt me possibly? He said it was typical, normal, that all lawyers destroy their records.

Simon Bernstein: If that, in fact, is the case—I've never heard of a lawyer you know other than Nixon destroying anything the work is ours. Am I right Chris when we pay for a lawyer and we pay for the work, the work is ours.

Wheeler: The work product is yours. He may maintain copies of his files and everything; or his confidential notes to himself are not necessarily yours. But the work "product" is...

Simon Bernstein: Would you say that anything germane to the issue belongs to him?

Wheeler: Well, I mean if he wrote notes...in sidebars...yeah.

Bernstein: How about revised patents[]. How about copies? Works in progress

Wheeler: But things which would reinforce your patent, obviously, that is germane to the strength of your patent yes, you would be entitled to copies I don't think we disagree.

Bernstein: He's claiming He destroyed all faxes.

Wheeler: Can I ask you a question?

Bernstein: Yes.

Wheeler: Just so both of us understand...was this patent done prior to his flying down here, or was this patent done as a result of his flying down here and having discussions with you? I was under the impression that when he flew down here—this was before Brian came—I was under the impression that followed our meeting with Reel 3-D. I was under the impression that he was coming down to discuss, at the very least, the video aspect so that you could complete that; but were you also completing the imaging patent?

Bernstein: Correct.

Wheeler: So he went to your [kitchen]?

Bernstein: Right. And we spent days there

Wheeler: And the two of you spent all the days...

Bernstein: Correct.

Wheeler: And did he, in front of you, write notes?

Bernstein: Tons. Hundreds

Wheeler: And did he then produce them on his computer and type out certain things?

Bernstein: Yes.

Wheeler: I was under the impression he was doing that with you.

Bernstein: He did.

Wheeler: And did you read those?

Bernstein: I did. I did - now going to that same nature, that's the provisional I think we're talking about...

Wheeler: Right.

Bernstein: But he flew out here again with me and Brian and went through this as he went to file this--this is a 3/23/2000 file--that also fails to make mention of.

Wheeler: So that's the formal file...the formal one?

Bernstein: The formal file. So both also missed the point.

Wheeler: I just wanted to know and to put things in proportion, when you read the provisionals, because Brian wasn't with the company right now and then, and when there were all those drafts, because obviously we didn't see them...

Bernstein: Well, you saw because we gave you all the documents. I'd get a document from Ray and bring it to you so you would have records of everything up to that point because I didn't want to keep them at my house.

Wheeler: The final...the final...but I'm not reviewing the patent. I was keep maintaining it as...

Bernstein: Okay, but you have every record...

Wheeler: Everything you gave me we maintain. We don't...

Simon Bernstein: Any notes should be produced...

Wheeler: We don't throw away anything.

Bernstein: Yeah, I know.

Simon Bernstein: I know you don't you're very thorough.

Wheeler: So, I'd file it away; so if you gave it to me, it's in our archives.

Bernstein: Right.

Wheeler: I wanted to know, when you read those drafts...

Bernstein: Oh, it was...it was clear

Wheeler: Answer my question...when you read the drafts, did you see the panning and scanning elements?

Bernstein: Yeah, and zooming, up to 1,000 times we thought it was. That was the big...you know, we had it in there...as a matter of fact, he just said it...somewhere it's in there up to 1,000 times, isn't it?

Utley: 1,700.

Bernstein: Right. That was our old mistaken a number of times. So, yeah, for him to miss that, Chris, would be the essence of stupidity.

Wheeler: So it was in there?

Bernstein: Absolutely.

Utley: The zooming, it was in the body, but not in the claim.

Boehm: But a provisional doesn't really...doesn't have to have claims.

Utley: It doesn't have claims.

Bernstein: But then in our claims of our patent, it's not there. This is what you're representing, correct?

Wheeler: So you're saying that it wasn't put in the file, but it was put in the provisional.

Boehm: No, I could see where he's going to argue that it's there.

Bernstein: Let's see. Let's take a look.

Wheeler: ...what the language of the patent claims are that he filed.

Bernstein: Okay, let's see what he...

Wheeler: And this isn't the final decision because I can go back right now and amend those claims.

Bernstein: Wow, yes, but we have elements of exposure that creep in correct?

Wheeler: I'm just telling you the whole thing, then we'll go back. So you did look it over, and there are no claims in the provisional?

Boehm: There are no claims in a provisional. You can file them, but they are never examined.

Wheeler: But the zooming and the panning and the scanning element was incorporated in that?

Boehm: Go ahead, Brian.

Utley: Let me make sure that we say that properly. The provisional filing had a claims section which migrated into the final filing, but Eliot is correct in saying that the provisional does not need a claims section.

Boehm: The provisional never gets examined, so it doesn't need the claims. It just holds your place in line for one year.

Bernstein: But then when I look through this...

Simon Bernstein: Hold on, Eliot, I need to understand this. What you're saying, then, is assuming any negligence on his part, to that point the negligence doesn't become realistically damaging to the company until since he actually made a claim...since he actually made a provisional filing. Which took our place in line.

Boehm: If the provisional filing covered the invention, your place in line is only as good as the subject matter described in accordance with the law.

Simon: Obviously, it should have had the panning and zooming in there.

Boehm: Well, the word "zoom" is in there.

Bernstein: But not really to describe what we're doing.

Boehm: But do you see what I'm saying? It's only to the amount of subject matter that and attested where the average person skilled in the art could make and use an invention as it's described in this document, and without "undue" experimentation, without inventing it himself.

Simon Bernstein: Right.

Boehm: Now, this provisional application, you throw it...different patent attorneys do different things with it. On one end of the spectrum, you do an invention disclosure. Most big corporations have invention disclosure forms which leads the inventor to write out good disclosures and figures and things, and I've seen people actually file that invention disclosure because if you're coming up on a bar date, you don't have time to write an application or think about what your invention is. All you've got to do is get something on file, and then hope that it will protect...that whatever you had on file covered your invention.

Simon Bernstein: Is that what we've done so far?

Bernstein: No.

Boehm: I don't want to answer that, but that's the line.

Boehm: It's a grey question, it's a grey area, I think.

Wheeler: That's what we're aiming to do, that's what we're hoping to do.

Boehm: But on one end of the spectrum, you file very minimal work, and that's what Ray did on some of the applications, like on the one...

Wheeler: He was trying to do it in a broad...

Wheeler: He did say conceptually that his method was to do a broad stroke of it.

Boehm: Right. Well, a broad stroke on drafting the claims.

Wheeler: Okay. Right.

Eliot Bernstein: He's got to put the invention in!

Boehm: That doesn't happen in a provisional at all, generally. If you want to, you can write the provisional claims just so you know what you're doing, and it's actually used as subject matter; but the claims are never examined. It doesn't matter if it's in proper format or anything, it just sits there. Now, if you pick up the provisional a year later—it has to be within that year—if it's a real well done application, you just file it. There's no money involved in turning the provisional into a regular filing. Oftentimes, with these one-page disclosures, there's a substantial amount of money involved in taking that from there to there. The problem is you cannot add subject matter to the patent application later on once it's filed.

Bernstein: Unless it's really the patent application, correct?

Boehm: No, the subject matter has to be supported—has to be described—

Simon Bernstein: In the provisional.

Boehm: Uhhuh To that text, or you lose your filing date.

Wheeler: But the zooming element, then, is not in addition.

Boehm: Is not in addition? You mean...

E. Bernstein: It's not even in there.

Wheeler: You can't add subject matter. So if he did describe zooming, then it's not in addition.

Bernstein: Did he, ?

Wheeler: I am asking you whether he did or not?

Boehm: I'm not clear on what you mean. You can't add additional subject matter after the filing date of an application or you'll lose the right to that filing date.

Wheeler: The provisional? You can't add subject matter to the provisional?

Boehm: To any application...any patent.

Wheeler: But if he did describe the zooming, then the zooming element is not an addition in the formal.

Boehm: Right. It's supported. If he described it in the original, you can base claims on it later.

Wheeler: And have we said that the zooming is in the provisional?

Bernstein: Nowhere that I can see.

Simon Bernstein: Wait. You're the lawyer reading another lawyer's work. Is it in there?

Boehm: Do you have a copy of it?

Bernstein: Yeah, right here. It isn't in there if it bites you.

E. Bernstein: It's not in the filing either.

Simon Bernstein: It's obviously not in the filing if it's not in the provisional.

Bernstein: No.

Simon Bernstein: Can you make reference to something...let's say he uses the word "zoom".

Boehm: Exactly. I'm pretty sure the word "zoom" is in there, isn't it Eliot?

Bernstein: But what Doug's saying is that had you written the patent, you would have described the invention as the ability to do this cool zoom that we all...and just said this is the cool part of what we're doing. What Ray's missing in the outline is the ability for you to put a picture on a Web page.

Wheeler: He did know that an important element was the fact that when we went in and made it bigger, we didn't pixelate.

Bernstein: It didn't pixelate. Not in here at all.

E. Bernstein: Not even mention to that concept.

Bernstein: Complete failure. It's not.

Wheeler: But if said it doesn't distort when we zoom...

Bernstein: Nope. Nothing like that.

Wheeler: That's the same thing, isn't it?

Bernstein: Yeah, but he hasn't said anything...he doesn't even tell you ...

Wheeler: What about the panning element, or is that element not patentable?

Bernstein: No, that's part of the whole process is to be able to zoom while panning.

Wheeler: Here it is. "The above process can be utilized in order to create higher zoom capabilities with each new depth layer of an image..."

Bernstein: No, but that's a new depth layer which is bringing in another hotspot image, so it's really a completely different subject.

Boehm: Oh. Okay.

Boehm: Okay. Where is that?

E. Bernstein: I read it to, he's very crafty you know.

Boehm: "Where the zoom capacity of up to 1700 times or greater may be easily obtained with the [present conventions.]" Are they talking about the hotspot now?

Bernstein: No.

Boehm: No, it's the general zooming capability.

Wheeler: So it's not in addition.

Bernstein: Well, explain to him where it's missing.

Wheeler: You guys didn't put it in the formal...I don't mean you...he didn't put it in the formal one in the depth in that what we want to do it but he could have without it being construed as an addition.

Boehm: Yes.

Boehm: Well play lawyer on you now<Laughs; cannot understand his comment.>

Wheeler: Right - sorry

Boehm: Whether or not it's supported is a question that's going to be determined either between you and the examiner...probably not, it's between you and another

lawyer someday when the case is litigated. The question is And again, the test is: Can the average person skilled in the art—the average designer of this type of software—can he read this document and make and use of your invention without inventing it? That's the test. Now, whether he uses the word "zoom" in here and "magnification" later, that doesn't mater as long as he would have gotten it. If it is so simple to build by reading this, you don't need any subject matter. If you're combining three elements A, B, and C, and A, B, and C are standard in the art, and you tell them these are standard in the art, go combine A, B, and C, that could be a one-page application. The average person will pick it up and he could. It's a patent test. Are you with me? The more complex it is, the more you want it supported in this text.

Simon Bernstein: What if it is basically simple, and he just wrote it as basically simple, does that support our position anyway though?

Boehm: Does that support our...Sure...

Simon Bernstein: I mean, if we were to litigate against another person that infringes on our...

Boehm: An infringer.

Simon Bernstein: Supportable for the sake of argument?

Boehm: Right. Yes. That is a fair argument

Simon Bernstein: OK so then I don't know that, at least from first blush

Bernstein: That's the provisional you're reading though, right?

Boehm: Aren't they the same? I think they're identical, aren't they?

Boehm: You can check in his notebook.

Boehm: Are there differences?

Bernstein: Where did you find that piece that you just read?

Wheeler: Is the reason...now continue answering my question...is the reason we came to the formal in March of this year, which I didn't realize that Joao. I thought that we had agreements for doing everything, but apparently Joao filed...

Boehm: For that one, yes.

Wheeler: But he didn't bother telling anybody.

Boehm: That's the one that we didn't find out until way late.

Wheeler: Okay, perhaps the reason that he did that was that was the easiest way to do it and the course of least resistance, and he thought he could go back...is there an amendment procedure?

Boehm: Yeah, there's an amendment procedure.

Wheeler: That he could do it a few months later or something like that?

Utley: We had a conversation before the formal filing, and, in fact, I have my notes here from that conversation.

Wheeler: Okay.

Bernstein: And you mentioned that there was no zoom.

Utley: Yeah, I said...

Bernstein: Claim one.

Utley: Yeah, Here are my notes. This is my original copy. Claims do not reference stitching. The patent app does not cover providing enhanced digital image with zoom and pan controls. It covers for creating enhanced images to show zoom and pan functionality without distortion." Those are my notes.

Bernstein: And you told him that.

Simon Bernstein: Here's a man that was cognizant of what was necessary to be in there. How did a guy to file a patent without any of us—obviously, not me, but Eliot, Brian.?

Boehm: Jim wasn't around yet.

Simon Bernstein: Okay, but Chris was and so on and so forth—how did they get through the crack that he did this?

Wheeler: It didn't get through the crack. Brian addressed it with him.

Bernstein: And everything is shredded now, too. Everything else is shredded.

Utley: Kind of what he was going to do—his time factor—he was going to...he didn't think he would get this in. He would submit it and then would turn right around and amend it.

Boehm: Did he really say that?

Bernstein: Yeah.

Utley: I wouldn't say amended, it was because of the stuff that was coming...

Bernstein: It was supposed to be in there.

Utley: ...he was going to smash that all together and file it.

Simon Bernstein: Was that the same time, Brian, that he was leaving the firm?

Bernstein: Yeah.

Simon Bernstein: So would you say that probably...

Utley: he knew at the time that he probably would be leaving?

Utley: Right.

Simon: But he wanted to get all of this in place so he could do the billing and get that part of it in...

Utley: I don't know that.

Boehm: Just speculating.

Eliot Bernstein: What day did you give him those notes?

Simon Bernstein: I don't ever have to speculate on billing

Utley: I don't have my address book with me...I didn't write the date down, but it was the date that he was here. He came.

Wheeler: He wanted to get it done to take care of you, make sure it was filed for you.

Simon Bernstein: That could be too. One other reason is...

Wheeler: We're just speculating.

Wheeler: And I'm not trying to... <Everyone talking at once.> I thought he was trying to work on our best behalf, but one time or two times that I met him, it seems like he was earnestly trying to help. Who knows? Maybe he was incompetent. I mean we're only suggesting that it would have been incompetence

Bernstein: Well, the fact that it's not in your patents, right up front, this is the invention, is a gross neglect. And the fact that it doesn't say, "this is what the invention is trying to do. This is the feature..."

Simon Bernstein: The point is not whether it's gross neglect or not, it's what the damage is if there is...if, one, gross neglect is of any import; and two, what is the damage? it has caused iviewit. That's what I think we need to ascertain here, and if we can ascertain it.

Utley: How do we fix it?

Simon Bernstein: Of course lets try to fix it, if we can't fix it then we'll worry about...

Eliot Bernstein: Well 1st lets fix it

<Everyone talking at once.>

Boehm: Let me go over the procedures so everybody's clear. Again, on one end of the spectrum you file a very sparse, like a one-page provisional application, and it's cheap, and the purpose of the provisional is to get you in line...it is to protect your date. What you're trying to do is get the benefit of your priority date. When you invented it. When you're in line in terms of whose the next guy that invented it. Whose the first inventor?

Simon Bernstein: Someone comes after you the second day after...

Boehm: Who's the first inventor, that's what you're after.

Simon: I understand. I really understand...you don't physically stand...

Boehm: Not physically in line in the patent office is right, not or even in physically in line in order as well. Okay. One-year letter, the provisional expires and you have to file a non-provisional patent application, okay? Many times it's identical. If you do a good job up front, you just file that, but you need to put claims on at this time. When I do a provisional, I try, if there is money and time up front, to do it once up front. I even write the claims. As a matter of fact, I don't even like to file provisionals because there's not much of an advantage. If you've got the time and the money up front to do a good job, well then, just file it as a regular application.

Simon: Understand that at the beginning, the time and the money...I mean, the time was certainly available, but the money was a short substance. So it was obvious that Ray would be working in a most expeditious way.

Boehm: Well, that's why the..

Simon: Which might have short-circuited us because of all of the lack of funds.

Wheeler: Well, that's true because the filing date is 3/24/99 to endorse that...that was very early in the game.

Simon: We did it in your office Chris in your library...in your conference room. The only meeting I had with him was while we were going to file the patent and that was in your office.

Boehm: Okay, 3/24/99 is the provisional application.

Bernstein: That's what I'm saying. Well, Chris,

Boehm: So even at a year, he filed the second one with claims.

Buchsbaum: Yeah two things happened during the year. One, the Company was doing other things, even though they knew that was coming up, and two, I guess there wasn't a whole lot of money to allocate towards doing that much.

Simon: Here's what we did. We hired Ray Joao on the monies that were raised by the investors; and then when Huizenga was coming in with their money, and when that money came in, we made a company decision that the first and foremost thing was to get the patent filed properly. So the fact that we were going to spend more money and get them completed at that point had already been made.

Simon: Okay, but prior to that, we were working on short forms. Then after that, we started to raise capital, and we always knew that the priority was intellectual property, so were going to make sure that those got done right. Brian's been working on it ever since, and I felt comfortable...I never did feel comfortable with Ray Joao...just an observation.

Boehm: Hmmm...is it all patent attorneys? <Laughter>

Simon: No, no, there's nothing wrong. He came in, he's a nice guy, he tried hard, you know, all the nice things, but his work always appeared sloppy, okay? And that's the only thing I can say. You're a patent attorney, you see what he did. If I'm wrong, then let me know; but to me, it looked like it was a little slipshod. And then he made some statements that really bothered me, too, that I don't think he should have made to a client, and that is that he was filing his own patent. <Chuckling.> I mean, horseshit personally, I haven't heard of a patent attorney in my life telling me that he's an inventor filing his own patent. It really did bother me.

<Everyone talking at once.>

Bernstein: Transmitting video files on a communication network for airlines and...

Simon: It probably meant nothing because I don't think the guy was of the nature to be stealing from us, but I don't know! But I'll tell you this, it did ring a bell. From a pure novice, it made me a little nervous. I asked Eliot why he was dealing with somebody, but we were assured that this was a good firm...

Boehm: Let me look back in my own spiel...here with the provisional. You file a provisional, then within one year, you file a regular application with the claims. You can add claims to it; but if you add subject matter to it—in other words, if the zoom and pan concept wasn't well described, you have lost the benefit of that first phase. Right. Now

why is that going to hurt you? Two main reasons. One is if you put it on sale—offered it for sale— or you publicly disclosed it, there are certain regulations that say you've got to get something on file, so if you had publicly disclosed it, that would protect...getting the application on file will protect you from losing your date because of public disclosure and offer for sale. I think that's what he was trying to get the earlier dates for.

Simon: Sure.

Boehm: I spoke with Ray when I was trying to get all of these files, and his comments to me were...when we were on the phone—you remember, we were asking him where was this stuff, and he said, well, he kept building on and he learned more it got in there. After I reviewed these applications, I agree that you're learning more as you go along. I'm doing the same thing. So it's kind of a learning curve.

Bernstein: If they ever find a zoom description that adequately makes...especially in the claims...I mean, if you're reading the claims...

Boehm: But Eliot, he's going to say that the claims are of no import right now. All you have to do...

Bernstein: In the filings?

Boehm: In the filings. I can go amend those right now. We can sit down today and re-write them.

Simon: If it can be amended amend it. There's no problems.

Boehm: There's no problems.

Simon Bernstein: There's always maybe a little money that's been duplicated and that's it.

Boehm: Here's the problem, and that's what I want to get across about that. If he's trying to claim zoom and pan and I rewrite the claims to claim zoom and pan, and the examiner says, that's great, but it's new matter

Bernstein: But it's in the provisional that you can zoom up to 1700 times.

Boehm: If my claim is supported by the spec on that date, then you're fine.

Bernstein: Isn't it?

Boehm: I can't answer that without going into the...

Bernstein: But when we read the provisional and we see that, it says...

Simon Bernstein: Before this meeting took place, before we called this meeting, aren't you privy to everything that's been done?

Boehm: Oh, sure. I have everything.

Simon Bernstein: So when Eliot asked you that question, why can't you answer it?

Boehm: Because there's no...in my opinion, there's no clear-cut answer, yes or no, on the quality of the work product. It's a judgment call.

Bernstein: So that's an exposure, and what if the judgment is against us?

Wheeler: It's [an examiner] judgment call is what we're saying.

Boehm: The damage?

Wheeler: No, the examiner. <Everyone talking at once.>

Wheeler: Whether the subject matter is new or not.

Boehm: The examiner would...hold on...it's...

Wheeler: whose judgment call is it?

Boehm: It could be the examiner's, if he catches it. If it's not caught, and you get it to patent and you litigate the patent, ... at court. Or if the examiner catches it and I want to appeal it to the board of appeals in the patent office, it's their judgment call

Wheeler: Okay, so we go to court and we're fighting over the patent, we would argue that it's supported by the zoom 1700 in our language, and the other side would, say that's baloney that's too broad you didn't describe it enough

Boehm: You didn't have your invention...

Bernstein: Then you lose.

Boehm: We would lose only if you had a bar date come in there if somebody else invented before you, or if you put something on sale...or if we offered something up for sale.

Bernstein: Which we did.

Boehm: But the offer-for-sale date from our first meeting is not until September.

Bernstein: Right.

Boehm: So the offers for sale won't normally kick off a foreign...

Simon Bernstein: Could you explain to me what offer for sale means?

Boehm: Sure. As soon as you...you can't get a patent on a product after you've been using it for more than a year. As soon as you publicly disclose your invention, you've got one year in the United States to get a patent on file, okay? Even if you don't publicly disclose it...let's say I've got a method of making [] in my factory, but it never gets outside. I'm starting to commercialize it, I'm making money off my invention...the commercialization date a year later is you can't patent it in the U.S. So that's that one-year grace period.

Simon Bernstein: Aren't we within that period?

Boehm: Yes. As far as we know, yeah. As far as we know.

Utley: Yes-yes we are within that grace period

Simon: Okay, somebody explain to me, what am I doing here? Why am I sitting here? Are we saying that Ray Joao, other than being sloppy, but there's not much damage that could have been done or can be done because we can fix it, which really would make me the happiest to hear that.

[not in transcript: PSL look at change above although minor it indicates perhaps the change in text to match new text]

Utley: Can I jump in? Let's just say there are two steps. We're going to make a filing this week; and to the best of our knowledge, we have swept up all this in this filing, and that will be within the commercialization period. The second thing that we're going to do is we're going to look at filing an addendum to the original formal filing to strengthen the claims - broaden the claims ... to the maximum extent that we can.

Boehm: if we need it...if we need it.

Boehm: It'll be a lot of this was swept up into the application.

Utley: What we're trying to do is protect the date day of March 24

Boehm: The original...

Utley: The original date as March the 24th, but filing should remain an objective.

Simon Bernstein: Brian, if you broadened the language now, would that be a red flag to the commissioner that you should have done it earlier? Or should we just say that this has always been there?

Buchsbaum: You mean the examiner of the commission

Bernstein: We're not going to be able to say it was in the claim.

Simon Bernstein: What happens when you start those amendments or broaden them is you start to admit that you didn't do it.

Boehm: Um, yes and no. We...I do that all the time.

Simon Bernstein: It's common then?

Bernstein: If they do it all the time, then we have to do it.

Simon Bernstein: But not until I feel more comfortable with it.

Boehm: We normally have a search done. The patent examiner will do a patentability search, and he will come back and reject it. The problem is if the claims are too narrow to begin with, he will not come back and reject it, he'll allow it, and boom! Now I can't amend it he's in. [], we're done. But I can file an continuation on it. I can keep dragging this out and get broader claims as long as the subject matter is...

Wheeler: So that's why he stated it broadly versus narrowly?

Boehm: No.

<Somebody comes into the room to take food/and or drink orders.>

Boehm: No, but as far as, doing it broadly, if you're saying to claim it broadly it's our job to claim... as prior art which I doubt the claim is as broad as the [] allows...

Wheeler: Right. That's what I'm saying.

Boehm: And this is claimed broadly.

Wheeler: Right.

Boehm: And that's the normal tactic, to claim things broadly, and then wait for the examiner to come back and say, "Oh, you can't get it that broad," and then narrow down your claim.

Wheeler: Okay, so isn't that what he was in part trying to do? That's what he's been saying, yeah.

Boehm: Yeah.

Wheeler: Well, would that not be consistent with how patent attorneys try to do things?

Bernstein: Well, claim one, if you look at their claim one, Chris, that they've written, it identifies...

Wheeler: Who's they?

Bernstein: Foley & Lardner. It identifies what you're trying to do. [not in transcript: Stephen note how Dicks name is deleted and Foley's name is screwed up, may indicate who was changing this transcript]

Wheeler: Okay, so maybe it should have been written differently.

Boehm: You won't get two patent attorneys to write the same claims.

Bernstein: Well, no, but you try to write the claim, and that's the teaching you and Steve both represented us here, to describe in its broadest term...

Boehm: Right.

Bernstein: ...the invention.

Boehm: Well, I can't say that this isn't broad. This is very broad. This might be rejected for indefiniteness...I don't know what it is...but now he's got the opportunity to go back and...

Bernstein: And Brian, you know, there's print film image in here, it's all supposed to be out of here.

Wheeler: What you're telling me is that in your forum of law there's always going back and refining and refining and refining that was wrong.
<Everyone talking at once; two different conversations going on at once.>

Bernstein: This is like he just completely ignored what we said over a year. He didn't do a thing. Nothing. No comments, nothing.

Utley: Almost nothing between the provisional and the formal process.

Boehm: And some people intentionally file narrow just to get something on file. Then they can come back and repair it without damage to it.

Bernstein: But you don't know that because an examiner...

Simon Bernstein: You'll never know that until you have a litigation.

Bernstein: And then the question is what potential damage does that...

Simon: That damage potential and that remedy will be then taking place at that time, not now.

Boehm: That I agree with. Even if we decide something now, you won't know what the outcome is for five and a half months.

Simon Bernstein: ...wouldn't happen anyway. You wouldn't even know that.

Utley: Let me come back where I was. We are going to file on the 7th, Wednesday. As far as we know, that will cover every element of this invention that we have our arms around at this point in time.

Boehm: I believe so, yes.

Utley: And we should go back and address what amendments we can make to the claims in the filing of March this year and determine within the spec of the filing how broad those claims can be. I mean, that's going to be the test. Within the spec of that filing, how much leverage have we got to broaden those claims so that we do have a priority date which is back about a year ago last March.

Bernstein: So we want to insert everything going into this one into that one?

Utley: No, it'll be...

Utley: It'll be based upon the preamble, if you will, of what's in here.

Boehm: We do reference it. As a matter of fact, this is the cover page, Brian, of the application we're going to file.

Utley: Yeah, you reference it right there.

Bernstein: But you can add claims to that one that you're referencing that would encompass what we have in today's filing, which is really...we do want it in there.

Boehm: Yes, I can claims to the zoom and pan to get you back to the original date in this one since I claim to this onto his.

Bernstein: Well, we should do both.

Boehm: Well, you can't get two patents on the same invention, so it depends on where we want to go.

Bernstein: Well, we want to definitely get it in on his because it gets us an earlier date. Correct?

Boehm: No. It's a mess with these dates. What will happen is...nobody will worry about the date unless there's an occurrence, and that occurrence might... it's a major problem. You won't find out about that occurrence until you sue somebody, and then they go search in Australia, and they find a reference that somebody's done this before in the library, and then you worry about the date. Were you before him?

Bernstein: Well, that's what I'm worried about. I'd like to go back to our earliest date.

Wheeler: Can I point out one other thing? I know we look for the word...Eliot looks for the word...I know we look for the word "zoom," but there's also other language in here too. Sometimes we get caught up in a word "zoom," when what is zooming other than enlarging or reducing? And he does have language in here, "when enlarged or reduced, these pixels of the digital image becoming distorted a feature which

typically results in the digital image being fixed to an original size or being available at low magnification, such as, for example, magnification from 200 to 300 times. These digital images are also difficult to enlarge to a full screen without a tremendous amount of distortion present in the end product."

Wheeler: I mean, he's describing I mean that's zooming. Reducing and enlarging is zooming.

Bernstein: But he's not putting it in your claims, that's what he's saying. You see, this is different.

Boehm: But it doesn't matter right now

Wheeler: But it doesn't have to be if you've made mention. The opinion is that it doesn't have to be as long as he's ...if you made mention...if you've gone on record of having described this

Boehm: This is the background that's...problem. He's got...

Boehm: That kind of invention, right, it's got to state...

Wheeler: Well, I didn't get to that either.

Bernstein: Right. And that's where it's not.

Boehm: I pointed out a couple of things. It's not as...

Bernstein: Within the claims, the claims I'm reading, you could not...

Boehm: The claims really don't matter.

Bernstein: In the patent?

Boehm: The patent claims on a pending application basically don't matter.

Bernstein: No, the ones he filed.

Boehm: Yeah, they basically don't matter. I can go back and change them.

Bernstein: Okay. Why? So we want to change back to the original one he's filed, put as much language as we can that we have today...oh, it's all supported. Everything you wrote in that new one is supported in this one because it's the same process.

Boehm: That's the ultimate problem that Steve and I—Steve is Becker, the other patent attorney that actually wrote these patents <in audible>—but that's the ultimate problem that we're worried about, and that's the problem that you always worry about unless you first of all have a handle on the invention, inside and outside, and second of all, unless you really have a handle on Prior Art so you know where you

want to go with this. Then you spend the time and the money to do a good original provisional filing. You've got a pretty good shot that it's supported then. But when you file as, oh, I've got to try and cover this base, and when you do this kind of stuff, there's always going to be a question of what was supported when.

Bernstein: But that's fine. It is supported.

Simon Bernstein: We're off the subject matter.

Bernstein: So we should definitely claim back to the earlier date?

Boehm: We may get a rejection, or you may find out in litigation five years from now, that none of this was supported. Some court may say that you never talked how to do this because your software wasn't in the patent application.

Bernstein: It is, though.

Boehm: Well, the code isn't. They might say that these broad diagrams and these flowcharts aren't good enough. There's always that risk.

Bernstein: But we're trying to say that if they accept it, we want it to be to the furthest filing date that we can, which is March 3, 2000, and that's where it should lie; and if it's going to get argued let it live or die at that date.

Boehm: That's what we're trying to do right now.

Bernstein: Okay, good. So I'm under the impression from this point that we're going to encompass what we've learned what we're filing even in this other one even into the original one so we can claim back to a March 3 filing date that claims back to our original March patent...

Boehm: March 24th, yeah, all of that will go back toward what is supported in here, in the original. Not supported in ours.

Bernstein: Okay. And it's all going to be supportable because you're going to be able to pull up an image of the nature that we are discussing, and anybody with an eye can see that you've now done this.

Boehm: <Inaudible comment.>

Bernstein: Well, you're going to be able to show your invention, aren't you?

Boehm: No, no.

Bernstein: You can't?

Boehm: You live or die on what's in the specs. That's why...

Bernstein: Then get it in there.

Boehm: Yeah.

Bernstein: You can't bring it in as evidence what the invention is?

Boehm: Only outside evidence of what the average level of skill in the art is, okay? If somebody says that the flowchart isn't detailed enough, I'm going to go, "Oh, yes it is. Here's 29 programmers who are going to testify and say yeah, I can do that in my sleep with this document." So, there's always going to be a battle about the level of support.

Simon: Maurice and I—that's why I asked him to come in—Maurice and I were talking because neither one of us understands patents or how you file them or invention actually. What we do understand a little bit about is the theory in business; and now that we know that Ray Joao was somewhat sloppy—I'm not suggesting that he's not a fine attorney or anything else—you have been...you have reviewed all these patents that we have, whether there are eight or ten of them...

Boehm: There were eight original filings, and then...eight original filings.

Utley: Okay. And then how many do we have now?

Boehm: Let's look at the chart right now, but it's basically. We've got 17 applications that have been filed. These old ones are dead now because they were provisionals, and we've basically covered all...we pointed out basically covering two, maybe three inventions, so there's not...I mean, if we were to start over, maybe you'd do this with two patents, maybe one patent. So.

Simon Bernstein: Who owns them?

Boehm: Who owns it? iviewit Holdings, Inc.

Utley: Owns all of them?

Boehm: Except for...<Pause, and then text comes in that doesn't seem to be answering this open question.>

? Video playback over a network

Wheeler: How did he get in? [not in transcript but this refers to Jeff Friedstein on an invention]

Bernstein: He's part of the invention.

Boehm: An inventor - inventorship.

Boehm: So I've so I've got a document right here for him to sign. If he signs, then I do a couple of things.

Bernstein: He signed that when you faxed it to him originally.

Wheeler: I have copies of each one of these. Can I get a copy of your []?

Boehm: of this? Sure.

Wheeler: I have a copy of each one of these, I believe, or most of them...

Buchsbaum: Can I ask you a question? Your saying everybody that has an obligation to sign is on the list of names in these patents?

Boehm: You preferably don't...well, unless you have the new ones...

Wheeler: I don't have the new ones, but...

Bernstein: That's an old one. That's old.

Buchsbaum: You're saying everybody that has an obligation to sign is on the list of names in these patents right, because the company was part because the Company was doing, is that what you're saying? Because I don't even know if everybody has signed because you may due corporate due diligence for financial reasons or if...and they will say has everybody signed off on these patents, and if three people don't...if one person hasn't, he has an obligation to sign?

Boehm: Brian, have you signed?

Buchsbaum: Has everybody signed off on these? Brian?

Boehm: See these tabs [refers to tabs for inventors Bernstein, Shirajee, Friedstein and Rosario to sign] right here? That's what I'm trying to do today. As soon as...I'm going to have people sign, me sign...all the inventors sign. I've got to get a hold of Jeff

Bernstein: I thought we did that when we filed.

Boehm: You only signed one real document, didn't you? Did you actually a declaration? I know you didn't sign an assignment over but you're real clean on it because these are all based on the original filing , which is assigned to iviewit holding already

Bernstein: What's that mean?

Boehm: So all of the other inventors would have a helluva problem trying to say they owned anything.

Simon: Again, this is a little off the subject matter, but I have asked Chris about it before. If something were to happen to iviewit, and it were it went into bankruptcy, what would happen to those patents? How would those patents []?

Wheeler: It depends on which at iviewit you're talking about.

Simon Bernstein: The one that they are held in.

Wheeler: Well, first of all, holdings is held separately versus...we're operating the company out of a separate entity, correct? iviewit.com. So, let me think there...

Buchsbaum: The operating company is iviewit.com.

Simon Bernstein: All I'm concerned about is, for example, that the largest creditor...it wouldn't be a creditor, it would actually be an investor...would then...

Bernstein: They're not a creditor.

Buchsbaum: Okay, then the largest creditor could come in and pierce the corporate veil of iviewit.com and say that this is just a way of protecting the only valuable asset of the company away from creditors. Is there a possibility of that?

Boehm: Obviously there is.

Wheeler: There is a possibility, but that's one of the main reasons... But the loan, they made the company who wrote the patent, join in as a guarantor anyway on it.

Bernstein: Well, that would be all of us. All of those would be all of the investors getting a piece back?

Wheeler: No, no, no. On the \$800,000 loan, those people, it's secured by the patent.

Simon Bernstein: What about the \$600,000...or the other \$800,000 loan?

Wheeler: The others weren't loans. The others were equity, as I recall.

Simon Bernstein: No, no, they have claims.

Bernstein: Well, they're supposed to be converted to equity, which is another issue.

Utley: But there where note holders

Wheeler: No, because there was no quid pro quo at that time. The note holders I mean you can't go back and do it, we had that talk Si

Wheeler: I mean, you can't go back...

Bernstein: The note? I believe they're not final, even though we told people they would be by this time.

Wheeler: The note holders took their money in without taking security. Now you...<Indecipherable. Everyone talking at once.> ...new considerations...I said now you can't ... back to a failure to the corporation

Simon Bernstein: ...Board if everybody that was a creditor found, everybody that was a note holder at that point there was no what would you call it - problem

Buchsbaum: and that would be protected by the courts anyway usually. The court would see this probably as a you know a fraud

Wheeler: You could have two frauds: fraud of creditors and fraud of shareholders.

Simon: No, Chris I'm not worried about fraud. I'm really concerned with the fact that what we did here, the last loan that we took in, from...

Bernstein: Crossbow.

Simon: No, not from Crossbar...

Bernstein: Crossbow.

Wheeler: Crossbow

Simon: ...is secured by the...

Wheeler: ...the term of the deal, right.

Simon: And that's perfectly acceptable to me except that everybody else that had loans prior to that at that time should have been considered with the same equity because ...posses able and Chris told me that that was the perfect time to get it done

Bernstein: Yeah, but would Huizenga lose his?

Bernstein: Would Huizenga lose his stake in it to Crossbow?

Wheeler: No, no, no, it wasn't...I said that if there was going to be new considerations from those people, we all could of...??

Simon: We all could have put in another \$10. I mean, at the time we did it with Crossbow, we should have made sure that our other people...

Bernstein: Are protected.

Utley: No, no, no. We would have had to issue new contracts out for everyone.

Wheeler: There would have had to have been some material consideration, not just \$10. It would have been...

Simon: So it would have been \$10,000...

Wheeler: Well, then, you could have...Crossbow, we didn't even talk about Crossbow at that moment, and I said you couldn't go back and just collateralize. You couldn't go back for money that you already put in. But if you put in new

considerations that you could demand as a condition to be collateral.

Simon: What we should have done, or what we maybe we still should do to protect our original group of investors, is to have them pony up a few more thousand or whatever you think is legitimate, and amend the contracts to protect them as well.

Utley: That's new subject matter.

Simon: Well, I only brought it up because it had to do with the patents.

Utley: I know but can we finish the patent discussions before we bring up new subject matter.

Simon: You can, but I want to make sure that we do finish.

Utley: No, I agree with you Si.

Si: The problem is that I made claims to certain people like Don Kane, who put up \$100,000, who thinks...

Bernstein: Let's get back to that. No, let's get back to it. It's a definite point. There are people.

Buchsbaum: This is a business issue for later.

Bernstein: No, we're asked by these very people these questions.

Boehm: Did you get your question answered on the...

Buchsbaum: Yeah, I just wanted to understand...you know, I got an answer. It had to do with the obligations Si I was trying to understand if somebody does due diligence now with regards to understanding what is there and what has to be done, like those yellow tabs. [Yellow tabs indicate signatures of missing inventors]

Boehm: Yeah, but after...I find everybody, we can get guys to sign.

Buchsbaum: We aren't that many. I don't know on that sheet what you have, but I don't think there are that many names. There's what about five names?

Buchsbaum: There aren't that many...you don't have that many. I don't know on that sheet you have, I don't think there's that many names.

Boehm: No, there's not.

Boehm: So we have everybody but Jeff, if we can get Jude and Zak.

Buchsbaum: You just have to get people around and sign.

Boehm: No, that should not be and issue.

Buchsbaum: That might be questions brought up when people do do due diligence. Is everybody else on these?

Bernstein: That's why we're closing it. Right?

Boehm: We'll record what was in the patent office(...???) can do.

Utley: The other piece that's not in any part of the original filings, which is the reduction of the technology to a disciplined process—the mathematical representations of what's in and how it works and stuff like that.

Wheeler: (...???)

Buchsbaum: That will also be included in there, right?

Utley: We'll put it in the new filing...one of the new filings.

Wheeler: I form my opinion of everything, and we can talk about post solutions but I think Brian wants to get this back on track, but to me there's bad news and there's good news in this. The bad news is, just like anything in life, perhaps we would have liked to have tidied up some things better, like to have had Mr. Joao tidy them up. The good news is considering the state that the corporation was in in the early stages and the variable limited resources that it had, I'm glad that we have an awful lot on record that we do have on record, to be honest with you.

Simon: As long as it's not to the detriment of what we thought we were filing, I have no...I couldn't agree with you more.

Wheeler: But I think I like your approach, and I assume it's your approach, too, in that I assume that you're doing a fairly comprehensive new one, but then you're going to probably...

Utley: Claim priority back to the old one.

Wheeler: Right, but you're also going to do your amendment because now we're finding out that it's not an uncommon procedure and it's not a red flag.

Utley: Two things: the new filing on Wednesday will claim priority all the way back for as much as possible back to March 24th last year. Second, we will look at the March 24th year 2000 filing and determine how we should amend that to include additional claims and broaden that filing so that it more fully represents the knowledge of the invention as of that time.

Bernstein: Does it claim all the way back?

Wheeler: It'll go all the way back...

Boehm: as long as you don't go outside what was described.

Bernstein: No, the math is just describing the original invention.

Boehm: We'll, I'll never know the answer to that until it's litigated.

Utley: Due diligence.

Bernstein: Right, but from your perspective here, that's what we're setting up. Correct?

Boehm: We're going to try.

Bernstein: Okay.

Boehm: The question never even gets answered half the time in the real world. I will claim priority back on the document, and then if the examiner doesn't care, nobody cares

Bernstein: It gets through.

Boehm: It gets through.

Wheeler: Would it be a fair assessment—I'm posing this more as a novice, not as an attorney here—since we're not at IBM and we don't sit down at the very beginning and work out all these equations and all that, that in an invention such as this by a Ma-and-Pa type of inventor, and now since we're getting into the nuts and bolts and really uncovering, in essence, what's behind it, as Brian dissected it as we moved along, but that's all we're doing? I mean, that Ma-and-Pa inventors do that as they go along? They add the flesh to the bones as they go along?

Boehm: Boy, that happens, and we try not...we try to minimize the amount because if the flesh that you have to add is new subject matter and you've already sold your invention a year ago, you're dead.

Wheeler: Well no, Let me at it a different way. It does this, but I can't describe how it does this. But now we find out...we tell you what it does, now we're telling you in detail how it does it.

Boehm: Yeah, in terms of we claimed it properly.

Wheeler: So I'm not adding flesh in defense...

Simon: New flesh.

Wheeler: ...new flesh. I've got the box, now I'm disclosing what's in the box including the gears and how it works.

Bernstein: No.

Utley: No. Here's what the big difference is. The original filing claims a process for print film imaging.

Bernstein: Well, that was all stricken, by the way. That's why I'm having a big problem. I was going to get to that next, Brian.

Utley: Okay, good.

Bernstein: But we have discussed with Ray Joao numerous times to take out the references to print images out of this right here. Over the course of the year in the 59,000 modifications back and forth, we continuously pushed him away from the words that I see in this filing, and that's what's so disturbing to me because we sat here when...

<End Side 1; begin Side 2>

Buchsbaum: That would be conditional, probably.

Simon: Right, they probably will.

Wheeler: Their not going to want in fact their going to say take it off aren't they

Utley: No Crossbow notes would be converted to equity when someone else comes in.

Si? Of course, and that's gone. And those issues are gone.

Wheeler: Well, Yeah, so that it was the ...it was intelligent way to do it...and I'm not...

Buchsbaum: Crossbow would probably manage the million dollars anyway

Wheeler: By the way, if we did do a deal by which we tried to collateralize it even further, then we'd have to have some sort of provisions as well to get rid of your collateral.

Simon: Yes, of course. As soon as it converts to equity, it's gone.

Wheeler: But I mean, what if you didn't convert yours to equity[]?

Simon: Then you'd have to lose it anyway.

Wheeler: But at a point.

Utley: It just becomes a normal stockholder...

Simon: Right.

Wheeler: It would have to drop away or something. For instance, it would drop away when theirs drops away.

Utley: The stockholders, in the event of a default, the stockholders, the distribution that takes place, includes all the stockholders according to the rank of the preference. So the preferred get first cut, and the common stockholders get the second cut, whatever is left for

distribution. But of that amount[] unless there's nothing to distribute.

Simon: Not if one of the preferred stockholders has a collateralized position and the others don't. If one of these preferred stockholders...

Utley: There's no stockholders that have a collateralized position.

Simon: That's true.

Buchsbaum: You're talking about the small amount of money, that have any value, it should be reasonable value, and those would be taken out anyway.

Simon: Except that we seem to feel that we have an obligation to those, to protect the other stockholders who...had all good...I think its prudent anybody to ask permission

Buchsbaum: A good way to do it is the way he said to do it, and that's to [?].

Utley: Will you look it up and see what it's going to take to do it?

Wheeler: I'll coordinate that

Utley: I'm not clear. What are we trying to do? Are we trying to provide for collateral for new money coming in, or are we trying to...? We're not trying to collateralize money which has already been...

Simon: I don't know. Can you handle the old money the same way? I don't think so.

Wheeler: We have to see. We might be able to consider it for the full amount in the view of the fact that if you had enough substantial new consideration, ...

Buchsbaum: The problem is that you may have to go back to Crossbow to do that, and you may be better off just to do it on subsequent money.

Simon: Well, but to ask Don Kane to put up \$10,000 when he's got \$160,000 in the...\$135,000 in the company, and then he only gets 10%...\$10,000 worth of consideration...I'd like to protect his whole \$165,000, which is what he has.

Buchsbaum: The answer is you go back and ...

Utley: I don't think you can do that because that's equity. It's in common stock.

Bernstein: It's not equity. It's a loan.

Bernstein: Don had the stock prior to his putting up the money. These are loans. There's \$400,000 that's on the books. Then there's another \$100,000 besides what he put in originally. Sal has a loan on the books of \$25,000. Your guy should have had a loan on the books for \$250,000.

Utley: No, that's equity. Okay.

Simon: At any rate, <tape cuts out[tape does not cut out on my tape]>...While I got Chris here I'm going to take advantage of his being here.

Simon: One of the issues we tried to do when we raised the last \$80,000 that came from Eliot's two friends Anderson and Mitch Welsch. []

Bernstein: Ken Anderson.

Simon: It was my knowledge, according to Jerry, that those monies were to go to Eliot, and then Eliot was theoretically to loan the money to the company so that Eliot would have a loan on the books and he would have sold his stock because Eliot has some personal needs that he needs to accomplish as soon as we get funded or we get some money in here. I'm under the understanding again. It could be way off.

Bernstein: How do we work that out, Brian? The 10? A loan?

Utley: Yeah, that's better because otherwise you will get taxed.

Bernstein: Will they loan me \$10,000 to pay the taxes?

Simon: Who loaned you?

Bernstein: The company just today?

Utley: So I took that as a loan?

Utley: Yes.

Bernstein: The money went to the company, which spent the money already—the stock money—from Ken and Mitch.

Simon: You haven't sold any of your stock?

Bernstein: No.

Simon: You just made an officer's loan.

Wheeler: Right.

Simon: Is that how you handle it?

Simon: You loan the loan back by some method at some point.

Bernstein: Right. Correct.

Buchsbaum: That's the way to do that?

Utley: Well, there's no tax impact...

Simon: but he would have had a [] gain.

Bernstein: Right. And there were other things at the time...right, things. At the time, the company needed the money and I didn't...not that I didn't

Simon: Sure, I just wanted to make sure that it was done. I didn't even know ...???that bank account

Bernstein: Not that I didn't.

Simon: Let's finish up.

Utley: Eliot, let me summarize. I want to make sure we have an agreement of this meeting. Let me interject two final two points that we kind of skimmed over. One is you said that we want to go ahead and change the claims to go all the way back on this US, but we have sort of got covered on the one we're filing? The one we're filing is a PCT. It won't pop to the US for 18 or 30 months. Or we could file another PCT and a US, then the claims would hit the US. In other words what I'm saying is it would matter if we do the claims here. We could either fix up the claims here or file a PCT and a parallel US if you want US patent protection sooner. The PCT will split out to US, but not until later. You can file a US anytime...

Simon: Let me ask you. You're not a lawyer, what do you recommend?

Boehm: Well, it's more money up front.

Simon: How much money? A great sum of money?

Boehm: No, it's another grand to file.

Simon: For what we've spent already, let's do it.

Bernstein: And that protects us better?

Boehm: Quicker. You'll get a quicker US patent. It'll get you in line quicker.

Utley: The other point that you're making because in this week's filing we are going to claim all the way back...

Boehm: We're going to claim all the way back but this is what is supported

Utley: Right. So if we claim all the way back to March of last year, do we need to touch the filing that's already in motion?

Boehm: The one that's out there?

Utley: Yes the PCT. Do we need to touch that?

Boehm: No, no. There's a PCT and a US.

Utley: Right.

Boehm: The PCT, we will get a search back. In fact, we should get it in a month or so, and then you'll decide what you want to do with that, what foreign country and possibly the US, but he files the same thing basically in the US, and now it's in line in the US.

Utley: Right, right. But what I'm saying is if the new filing that we make this week creates priority all the way back and embraces all of the teachings of the prior...

Boehm: Zoom and pan stuff.

Utley: Zoom and pan stuff, filings, do we need to go and modify and update and amend those earlier filings?

Boehm: Those other two.

Buchsbaum: That's a good question would there be new recommendation?

Boehm: It depends on two things. One is how quickly do you want to get the US for the new filing? This is a PCT that we're preparing right now. If we file the US right away with it, then it makes less difference.

Bernstein: Less?

Boehm: Less difference because he's in line sooner. That's all. It just depends on how soon you want to get your patent.

Bernstein: Well, we want to go for the sooner.

Utley: The sooner the better.

Boehm: The sooner the better then let me play with this

Bernstein: Right.

Boehm: Plus you're gonna get an office action back from the patent office on him...

Bernstein: On that.

Boehm: For free. There's nothing involved.

Bernstein: Right, but it doesn't claim anything.

Boehm: I don't know yet. It claims...he'll get this blasted. It will will be rejected.

Bernstein: Yeah.

Boehm: It will be rejected. The question is do we want to fix this, or where are we with the other things? So there's no decisions to be made now on this, it's just that do you want to file a US and a PCT?

Utley: The answers yes

Boehm Yes

Bernstein: And we do want to fix the original work?

Boehm: We can decide that later.

Bernstein: Well, why would we leave it unfixed?

Boehm: Because you can't get two patents on the same thing. So if we fix this, you're not going to get it over here.

Bernstein: But then we lose the date.

Buchsbaum: No we don't.

Simon: That's what he's saying.

Buchsbaum: You really don't lose the date.

Wheeler: So were not going to...???

Utley: Because he's claiming all the way back.

Boehm: We may not. It depends on...

Bernstein: May and less, these are words that scare me.

Boehm: You don't like that, do you?

Bernstein: No, I do not.

Boehm: But I don't think this is the right time to make that decision now.

Utley: What is the right time?

Boehm: When we get some office action back on this patent. And when we hear from the patent office, we'll sit down say do we want to fix this, or do we want to fix this, or have we uncovered some killer Prior Art that blows this whole thing out of the water? You don't want to spend money right now if you can avoid it.

Wheeler: We've never done a search, have we?

Boehm: We did a search...I've done a search on...<Everyone talking at once.> on a dozen patents that really weren't on point. We didn't find any close Prior Art; and all I can tell these...

Wheeler: This was on imaging and video?

Boehm: Yeah.

Wheeler: That's incredible.

Buchsbaum: Yeah, it was huge.

Bernstein: If it is found impossible to do these things, why would people be doing them?

Boehm: I want to make...the tape recorders off, right? <Recorder turned off>

Buchsbaum: What does PCT mean?

Boehm: Patent Cooperation Treaty. It's a formal filing process for filing foreign patents.

Buchsbaum: Oh, that's the thing with the different countries?

Boehm: Yeah. So we file one application that splits out later to different countries.

Buchsbaum: Two years?

Boehm: Yes, but we'll get indicators before that. Our search comes in nine months, which is three months from now for the first one. But, Brian, they're searching this claim; this claim is crap. You're not going to get a good search on it.

Buchsbaum: So what? In six months or nine months, we'll start hearing from them?

Boehm: Yeah.

Bernstein: Well then we should do an alternate search on what you have.

Boehm: It's a judgment call. I mean, you asked me this question a while ago, and you said what would it take to get me comfortable because I'm kind of a pessimist and I'm an engineer, so I have that background where I look at it that it's half empty. It would take more searching, and it would take more searching inside the technical articles. And it would take quite a bit of work. I mean, I guess \$5,000, I don't know. It depends on what happens. Then, again, that will only raise you to a different level of comfort, that's all.

Bernstein: And then they'll say the same thing, and for another five grand, well get Rays to another indiscriminate level of comfort.

Boehm: Exactly. But we don't have to do that because we will be getting an article...

Bernstein: Right, from the searches.

Boehm: And from your investors because if I was working for them...

Buchsbaum: Let me put it another way. If you have somebody that will take this company and auction off the technology, okay? As it is existing...as it is unfolding, okay? And as the licenses come along. It's strategy. Some of these people bid on that. What are they really bidding on? It's potentials, right? Basically?

Boehm: Well, no, there's a present value of the technology. If you...

Buchsbaum: Well, not if you don't have patents issued on it.

Boehm: Well, sure there is. Sure there is. If he can get a royalty based on 2% of their products—or whatever it is—per minute, whether or not it is patented, absolutely.

Buchsbaum: My question is at what point does it become...is the efficacy there significantly enough from the standpoint of others now that would be doing their own review. You know, like, say a firm that would do the option. They'd have their patent lawyers take a look at what you're doing to see if they think it has a real good value. At what point does that come along? Is it six or nine months from now, basically? Is that when that probably would start to unfold as far as having a real relevant potential value? I've been trying to get a general..

Boehm: I understand your question. I guess I would answer...

Buchsbaum: General idea.

Boehm: If your licensees are spending a lot of money...

Buchsbaum: On your technology.

Boehm: On your technology, they're going to have their patent attorneys right now, today, go do a search, and they will have a good indication. They may come up with Prior Art that blows you out of the water. They may find nothing. They may not search it. They may say, we don't care about patents; it's the technology.

Buchsbaum: Reality, though, this is not the...more likely six to nine months as some licenses start to unfold here and as things start to come back, and that's when this thing will start to have some relevance more than it does right now? From the standpoint of the...

Boehm: That the patent will have relevance?

Buchsbaum: No, no. The technology has a value that can be created in the marketplace and turned to bidding.

Wheeler: Well, you can look at the technology as almost value added to the company. I mean, the company has worth because of the process and what we can provide and we can build it up. But it'll even astronomical more worth assuming that we have...that it's totally proprietary to ourselves. Now some companies have great technology that's proprietary to themselves, and it doesn't earn them money. For instance, Wang Laboratories went down the tubes. They had the best word processing, and they had the best of everything else. And, of course, a lot of their technology is licensed out there, as I understand it, to VisionAire and to...they did the true ones, and...

Buchsbaum: It's was also to get to the possible strategy for the company's investors, okay?

Utley: Right.

Buchsbaum: Or it may be at some point a window of huge value placed on this technology where you may take advantage of it.

Wheeler: Well, and to our investors, we have said, and we can continue to say, we are attempting to create a pool of intellectual property and protect it.

Buchsbaum: Okay.

Wheeler: But there can be no assurances that this will withstand the test of time.

Boehm: That is exactly it. And you never want even when it issues. You will get a good comfort level when you have a US patent issued in your hands.

Bernstein: Why?

Boehm: Because you've had an examination.

Buchsbaum: Because you've got some review.

Boehm: Because you have a presumption of validity.

Bernstein: That's why I'd like to get that first one corrected because that's the first one that's going to be examined.

Boehm: No, we've got one...oh, yeah, it is. It's the US.

Bernstein: And therefore I want that to be approved. The investors are going to say...

Buchsbaum: The first one that we're going to be issued will be issued in May.

Bernstein: And the investors are going to say what happened to patent one.

Boehm: 3/10 of 2000 was when it was filed. Typically a year...they'll get around to it within a year. Maybe it'll issue in. 18 months to two years

Buchsbaum: From right now or from then?

Boehm: From 3/10.

Bernstein: What is the process speed up? If you can show...

Boehm: If you can show somebody's infringing, you can have an expedited examination; but that doesn't always buy you much time, and you really have to get into the patent office the first time, and I'm not sure we can do that.

Wheeler: Wouldn't a good example of one way be that Apple had really great patents, and Microsoft was still able to come in and duplicate it, even though everyone knows they violated the hell out of the patent of Apple.

Boehm: Um, hum.

Wheeler: So I mean you could have a good patent and it could still go down the tubes. But another one I'm thinking of that did stand up was Polaroid had patents and Kodak tried to come in and do everything to distinguish, and wasn't able to and got clobbered, right? And there's probably a lot of every variation in between.

Boehm: Yeah. Wheeler: [Not in transcript this is strange here]

Wheeler: Are those the two extremes?

Boehm: Yeah,

Wheeler: those would be the two extremes.

Utley: Especially when it comes to method patents and software patents.

Wheeler: Yeah, what was the first thing that Brian

Boehm: ...and the more patents you have, the less chances. It's like putting out mine fields...less chances people to get around you. But if the original concept is broad enough and claimed right, Yeah, we can be okay.

Boehm: But what, the test - I guess what you're asking for is when we have that first claim promised, probably within two years of when you filed, which is March 10, 2000, I would probably say

Utley Doug come back, close it out again.
<Inaudible comment.>

Boehm: There were two points. One was the PCT and I got that in correct.

Buchsbaum: Right.

Boehm: The second point was everybody was saying you don't destroy documents. Lawyers do destroy documents; and in the patent realm, it is common practice to get rid of all of our attorney notes, but it depends on what the practice is in your law firm and your corporation. Most patent attorneys who use this practice that I've seen, it happens after it issues. You never do it before. I don't even like to do it then. I like to do it after all the...

Bernstein: I don't even understand why you're destroying it. If you've got nothing to hide and everything's on the up-and-up.

Boehm: But throw in the concept that I'm leaving the law firm. Let's say I'm leaving the law firm, my notes, who's going to follow up and destroy my notes to benefit you, because I do want them six months from now. Maybe that's what he's doing.

Wheeler: Yeah, he could have done it to protect you. He didn't want them around in the other office.

Bernstein: I don't know. I don't know. I don't even know if he knew he was leaving then.

Boehm: Now it's intentional!

Utley: But I want to comeback were going to file PCT and US on the new one. We're going to wait for the old one to get kicked back; and when it gets kicked back by the examiners, we'll then determine how we want to amend it. Is that what you said?

Boehm: No, I want to say something on that again. I think if you want a patent to pop quickly—if that's the goal, which sounds like it's a good goal—then, no, I think we should amend the claims with a preliminary amendment before the examination.

Utley: A preliminary amendment?

Boehm: A preliminary amendment.

Bernstein: Encompassing everything we can throw in there?

Boehm: Yeah, whatever support there is. But a preliminary amendment on whatever it is on the...

Bernstein: So we're going back to the original

Boehm: So I'll fix the 119 case yeah

Bernstein: March 3, 2000, to encompass what we've embraced.

Utley: When will you be in a position to recommend what that amendment will look like?

Bernstein: It should look a lot like the one we just did.

Boehm: Yeah, that's...

Bernstein: That's my guess.

Utley: When will you be in a position to...

Boehm: I'd have to...a few days...

Utley: About a week or so?

Boehm: Oh, Yeah, within a week, sure.

Bernstein: Okay. That's good.

<End of meeting.>



Utley Is that your understanding

E Bernstein Correct

Utley The purpose of this meeting is to review the facts and I think there are two particular points that are ...that are important to moving ahead. The first is: "Given that the filings are what they are, and given what we know about the filing which is scheduled to take place this week on Wednesday, what means do we have to correct the situation; and given whatever corrections we find, what then is the impact or exposure to iviewit based upon what actions we can take. Then, lastly, what, if any, recourse might iviewit have vis a vis the omissions in the original filings Are there any other issues, Doug?

Bernstein: Yeah, just correcting back to Ray Joao's work of the formal filing that he filed. Do we have a copy of that?

1

Utley: I do have that.

Bernstein: I don't. I've got the provisional and I've got...

Boehm: Everything is on the table

Utley: you should have...the formal.

Bernstein: This one?

Utley: Yes, that's the formal.

Bernstein: Okay.



SUSPECT FACSIMILE WITH 1900 DATE

FROM :

1900-03-10 12:04 B440 P.02/04

LAW OFFICES
MELTZER, LIPPE, GOLDSTEIN & SCHLISSEL, P.C.

THE CHANCERY
190 WILLIS AVENUE
MINEOLA, NEW YORK 11501
(516) 747-0300

DATE: March 10, 2000 TIME: 9:29AM
Telecopier Message From: RAYMOND A. JOAO, ESQ.
of Meltzer, Lippe, Goldstein & Schlissel, P.C.
Please deliver the following pages to:

TO:	MR. ELIOT BERNSTEIN
OF:	IVIEWIT
FAX NUMBER:	561-999-8810
NUMBER OF PAGES, INCLUDING THIS COVER PAGE: 5	
COMMENTS/INSTRUCTIONS:	
<p>Re: Patent Application Entitled: APPARATUS AND METHOD FOR PRODUCING ENHANCED DIGITAL IMAGES</p> <p>Our Ref. No. : 5865-1</p>	
<p>Eliot - attached herewith please find the a Declaration, a Small Entity Statement - Independent Inventor and a Small Entity Statement - Small Business Concern.</p> <p>Please sign and date the Declaration and Small Entity Statement - Independent Inventor where indicated and have Brian Utley sign the Small Entity Statement - Small Business Concern where indicated and return the signed, dated documents to us via facsimile (516-747-9363) as soon as possible so that we may file the above-indicated patent application in the PTO today.</p> <p>If you have any questions, please do not hesitate to contact me.</p>	

Transmitting
from a PinPoint 733 Digital Facsimile Transceiver. The FAX number is (516) 747-9363. If you do not receive all of the pages, please call us back as soon as possible at (516) 747-0300, extension 247.

THIS MESSAGE IS INTENDED FOR THE USE OF THE INDIVIDUAL OR ENTITY TO WHICH IT IS ADDRESSED AND MAY CONTAIN INFORMATION THAT IS PRIVILEGED, CONFIDENTIAL AND EXEMPT FROM DISCLOSURE UNDER APPLICABLE LAW. IF THE READER OF THIS MESSAGE IS NOT THE INTENDED RECIPIENT, OR THE EMPLOYEE OR AGENT RESPONSIBLE FOR DELIVERING THE MESSAGE TO THE INTENDED RECIPIENT, YOU ARE HEREBY NOTIFIED THAT ANY DISSEMINATION OR COPYING OF THIS COMMUNICATION IS STRICTLY PROHIBITED. IF YOU HAVE RECEIVED THIS COMMUNICATION IN ERROR, PLEASE NOTIFY US IMMEDIATELY BY TELEPHONE AND RETURN THE ORIGINAL MESSAGE TO US AT THE ABOVE ADDRESS VIA U.S. POSTAL SERVICE. THANK YOU.

205406.1

43



Please type a plus sign (+) inside this box →

PTO/SB/01 (12-97)

Approved for use through 9/30/00. OMB 0651-0032
Patent and Trademark Office, U.S. DEPARTMENT OF COMMERCE
a valid OMB control number

DECLARATION FOR UTILITY OR DESIGN PATENT APPLICATION (37 CFR 1.63) <input type="checkbox"/> Declaration Submitted with Initial Filing OR <input type="checkbox"/> Declaration Submitted after Initial Filing (surcharge (37 CFR 1.16 (e)) required)	Attorney Docket Number	5865-1
	First Named Inventor	Eliot I. Bernstein
	<i>COMPLETE IF KNOWN</i>	
	Application Number	/
	Filing Date	
	Group Art Unit	
	Examiner Name	

As a below named inventor, I hereby declare that:
 My residence, post office address, and citizenship are as stated below next to my name.
 I believe I am the original, first and sole inventor (if only one name is listed below) or an original, first and joint inventor (if plural names are listed below) of the subject matter which is claimed and for which a patent is sought on the invention entitled:

APPARATUS AND METHOD FOR PRODUCING ENHANCED DIGITAL IMAGES

the specification of which *(Title of the Invention)*
 is attached hereto
 OR
 was filed on (MM/DD/YYYY) _____ as United States Application Number or PCT International Application Number _____ and was amended on (MM/DD/YYYY) _____ (if applicable).

I hereby state that I have reviewed and understand the contents of the above identified application, including the claims, as amended by any amendment specifically referred to above.
 I acknowledge the duty to disclose information which is material to patentability as defined in 37 CFR 1.56.

I hereby claim foreign priority benefits under 35 U.S.C. 119(a)-(d) or 365(b) of any foreign application(s) for patent or inventor's certificate, or 365(a) of any PCT international application which designated at least one country other than the United States of America, listed below and have also identified below, by checking the box, any foreign application for patent or inventor's certificate, or of any PCT international application having a filing date before that of the application on which priority is claimed.

Prior Foreign Application Number(s)	Country	Foreign Filing Date (MM/DD/YYYY)	Priority Not Claimed	Certified Copy Attached?	
				YES	NO
			<input type="checkbox"/>	<input type="checkbox"/>	<input type="checkbox"/>
			<input type="checkbox"/>	<input type="checkbox"/>	<input type="checkbox"/>
			<input type="checkbox"/>	<input type="checkbox"/>	<input type="checkbox"/>

Additional foreign application numbers are listed on a supplemental priority data sheet PTO/SB/02B attached hereto.

I hereby claim the benefit under 35 U.S.C. 119(e) of any United States provisional application(s) listed below.

Application Number(s)	Filing Date (MM/DD/YYYY)
60/125,824	03/24/99

Additional provisional application numbers are listed on a supplemental priority data sheet PTO/SB/02B attached hereto.

[Page 1 of 2]

Burden Hour Statement: This form is estimated to take 0.4 hours to complete. Time will vary depending upon the needs of the individual case. Any comments on the amount of time you are required to complete this form should be sent to the Chief Information Officer, Patent and Trademark Office, Washington, DC 20231. DO NOT SEND FEES OR COMPLETED FORMS TO THIS ADDRESS. SEND TO: Assistant Commissioner for Patents, Washington, DC 20231



Please type a plus sign (+) inside the box →

PTO/SB01 (12-97) Approved for use through 9/30/06. OMB 0651-0032 Patent and Trademark Office, U.S. DEPARTMENT OF COMMERCE

Under the Paperwork Reduction Act of 1996, no persons are required to respond to a collection of information unless it carries a valid OMB control number.

DECLARATION — Utility or Design Patent Application

I hereby claim the benefit under 35 U.S.C. 120 of any United States application(s), or 365(c) of any PCT international application designating the United States of America, listed below and, insofar as the subject matter of each of the claims of this application is not disclosed in the prior United States or PCT international application in the manner provided by the first paragraph of 35 U.S.C. 112, I acknowledge the duty to disclose information which is material to patentability as defined in 37 CFR 1.56 which became available between the filing date of the prior application and the national or PCT international filing date of this application.

U.S. Parent Application or PCT Parent Number	Parent Filing Date (MM/DD/YYYY)	Parent Patent Number (if applicable)

Additional U.S. or PCT international application numbers are listed on a supplemental priority data sheet PTO/SB02A attached hereto.

As a named inventor, I hereby appoint the following registered practitioner(s) to prosecute this application and to transact all business in the Patent and Trademark Office connected therewith: Customer Number Registered practitioner(s) name/registration number listed below

Name	Registration Number	Name	Registration Number
Raymond A. Joao, Esq.	35,907		

Additional registered practitioner(s) named on supplemental Registered Practitioner information sheet PTO/SB02C attached hereto.

Direct all correspondence to: Customer Number or Bar Code Label Correspondence address below

Name: Raymond A. Joao, Esq.,
 Address: Melzer, Linde, Goldstein & Schlessel, P.C.,
 Address: The Chancery, 190 Willis Avenue
 City: Mineola, State: NY, ZIP: 11501
 Country: USA, Telephone: 516-747-0300, Fax: 516-747-9363

I hereby declare that all statements made herein of my own knowledge are true and that all statements made on information and belief are believed to be true; and further that these statements were made with the knowledge that willful false statements and the like so made are punishable by fine or imprisonment, or both, under 18 U.S.C. 1001 and that such willful false statements may jeopardize the validity of the application of any patent issued thereon.

Name of Sole or First Inventor: A petition has been filed for this unsigned inventor

Given Name (first and middle (if any)): Eliot L. BERNSTEIN
 Family Name or Surname: BERNSTEIN
 Inventor's Signature:
 Date: 03/09/00
 Residence: City: Boca Raton, State: FL, Country: USA, Citizenship: USA
 Post Office Address: 500 S.E. Mizner Blvd., Suite 102
 Post Office Address: Boca Raton, FL 33432-6080
 City: Boca Raton, State: FL, ZIP: 33432-6080, Country: USA

Additional inventors are being named on the supplemental Additional Inventor(s) sheet(s) PTO/SB02A attached hereto

RS



BILLING RECORDS OF MLGS WITH UNBILLED FACSIMILES



COPY OF PATENT DOCUMENT WITH UNREADABLE DATE

PTD-105P
Rev. 8-95

PROVISIONAL APPLICATION
FILING RECEIPT



UNITED STATES DEPARTMENT OF COMMERCE
Patent and Trademark Office
ASSISTANT SECRETARY AND COMMISSIONER
OF PATENTS AND TRADEMARKS
Washington, D.C. 20231

APPLICATION NUMBER	FILING DATE	FIL FEE REC'D	ATTORNEY DOCKET NO.	DRWGS
60/137,297	06/03/99	\$75.00	5865-3	0

RAYMOND A JOAO
MELTZER LIPPE GOLDSTEIN & SCHLISSEL PC
190 WILLIS AVENUE
MINEOLA NY 11501

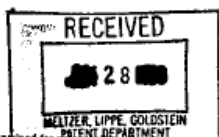

Receipt is acknowledged of this Provisional Application. This Provisional Application will not be examined for ~~substantive~~ ~~novelty~~ ~~or~~ ~~obviousness~~ ~~under~~ ~~the~~ ~~provisional~~ ~~application~~ ~~process~~ ~~and~~ ~~the~~ ~~PROVISIONAL APPLICATION NUMBER, FILING DATE, NAME OF APPLICANT, and TITLE OF INVENTION~~ ~~when~~ ~~inquiring~~ ~~about~~ ~~this~~ ~~application.~~ ~~Fees~~ ~~transmitted~~ ~~by~~ ~~check~~ ~~or~~ ~~draft~~ ~~are~~ ~~subject~~ ~~to~~ ~~collection.~~ ~~Please~~ ~~verify~~ ~~the~~ ~~accuracy~~ ~~of~~ ~~the~~ ~~data~~ ~~presented~~ ~~on~~ ~~this~~ ~~receipt.~~ ~~If~~ ~~an~~ ~~error~~ ~~is~~ ~~noted~~ ~~on~~ ~~this~~ ~~Filing~~ ~~Receipt,~~ ~~please~~ ~~write~~ ~~to~~ ~~Box~~ ~~Provisional~~ ~~Application~~ ~~within~~ ~~10~~ ~~days~~ ~~of~~ ~~receipt.~~ ~~Please~~ ~~provide~~ ~~a~~ ~~copy~~ ~~of~~ ~~the~~ ~~Provisional~~ ~~Application~~ ~~Filing~~ ~~Receipt~~ ~~with~~ ~~the~~ ~~changes~~ ~~noted~~ ~~thereon.~~ ~~This~~ ~~Provisional~~ ~~Application~~ ~~will~~ ~~automatically~~ ~~be~~ ~~abandoned~~ ~~twelve~~ ~~(12)~~ ~~months~~ ~~after~~ ~~its~~ ~~filing~~ ~~date~~ ~~and~~ ~~will~~ ~~not~~ ~~be~~ ~~subject~~ ~~to~~ ~~revival~~ ~~to~~ ~~restore~~ ~~it~~ ~~to~~ ~~pending~~ ~~status~~ ~~beyond~~ ~~a~~ ~~date~~ ~~which~~ ~~is~~ ~~after~~ ~~twelve~~ ~~(12)~~ ~~months~~ ~~from~~ ~~its~~ ~~filing~~ ~~date.~~

Applicant(s) ELIOT BERNSTEIN, BOCA RATON, FL.

IF REQUIRED, FOREIGN FILING LICENSE GRANTED 06/22/99 ** SMALL ENTITY **
TITLE
APPARATUS AND METHOD FOR PRODUCING ENHANCED VIDEO IMAGES

DATA ENTRY BY: SMALL, DONNA TEAM: 05 DATE: 06/22/99

FOR MORE INFORMATION VISIT US ONLINE AT WWW.USPTO.GOV OR CALL 1-800-351-5000

(see reverse)



COPY OF PATENT FILINGS WITH MISSING POST OFFICE STAMP

Receipt is officially acknowledged of the following papers:

- Check for \$ 75⁰⁰ *Cover Sheet*
- Application Papers: Specification, ~~Claims, Abstract~~
- Declaration; Power of Attorney
- Assignment; Recordation Cover Sheet
- Small Entity Declaration
- Priority Document
- Drawing(s) [Sheet(s)]
- Preliminary Amendment
- Information Disclosure Statements: PTO-1449 w/references
- Amendment
-
-
-
-

the date stamped hereon: June 3, 1999
Submitted in the case: 5865-3 - Prev. Pat. App!
Serial No.:

Express Mail - EL 355808458US

NOW COMPARE ABOVE COPY WITH BELOW POST OFFICE STAMP

58654

Receipt is officially acknowledged of the following papers:

- Check for \$ 400⁰⁰
- Application Papers: Specification, Claims, Abstract
- Declaration; Power of Attorney
- Assignment; Recordation Cover Sheet
- Small Entity Declaration
- Priority Document
- Drawing(s) [Sheet(s)]
- Preliminary Amendment
- Information Disclosure Statements: PTO-1449 w/references
- Amendment

Transmitted with receipt of [unclear]

the date stamped hereon: 
Submitted in the case:
Serial No.: 60/137,921

AUG 03 1999

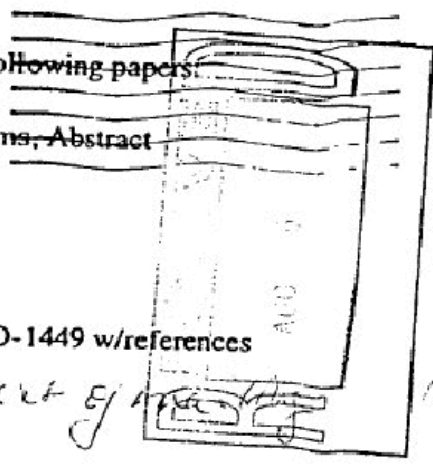



NOTES OF BRIAN UTLEY, FORMER PRESIDENT & COO

516.747.0653

3/9/2000

Guidance
BIN 1 2 F101

Ray Joas

Ray, there are major missing items in docket's 1+6:

1. Claims do not reference stitching
2. Process is amended as shown on the diagram
3. The relationship between the enhanced digital image and the zoom and pan function together with controls is not clear
4. The description and claims stop at the production and loading of the image.

5. Object model Brian



EXHIBIT F



RESPONDENT'S NEW YORK MEETING WITH STEVEN FILIPECK AND MR. RUBENSTEIN

Rockaway 21st Floor

Steve Filipeck - Fish + Richardson

9/20/99

32mm → wide angle lenses

image cameras

take out all specific software + hardware

magnification vs zooming

* scan directly from the film w/ enlarger

JPEG file is always compressed
difference is bit.

if lowest compression is introduced virtually no
artifacts - no compression - you narrow
color compression - lose definition

* put in more detail as to how the process works

#7 Video - straight through live computer to
camera then capture device + onto the web

** When you take/process a live capture or capture
from a record medium + process it, you may
capture it in the processed + prepared form on
a computer storage medium which is streamable
process + stored in deliverable form.

** Computer stores the processed video +
stores it.



EXHIBIT G



COMPANY BUSINESS PLAN RECEIVED BY RESPONDENT

BP 1998

Custom Web page & Advertisement Creation - **iviewit's** team of ad consultants will make it easy for your company to have a first-class, top quality virtual reality web page. In addition, through our "email-to sale one click system, buyers can contact you directly from your advertisement or product via live web video teleconference.

20. SERVICE BUSINESS ANALYSIS

The ad business consists of thousands of smaller ad agencies and individuals, for every one of the few dozen well-known companies.

Advertising participants range from major international name-brand clientele to millions of individual PC users. One of **iviewit's** challenges will be establishing itself as a global advertising virtual community, positioned as a relatively risk-free, value added, corporate or individual purchase.

Note that this can be used for political services as well!!

Benefits of **iviewit** for Personnel Services - including employment, modeling and casting searches.

- Global screening of qualified candidates from an increased pool
- Videotaped candidate resumes further aid the selection process
- Live video conferencing of candidates to maximize selection process

15. FUTURE SERVICES

In the future, **iviewit** will broaden its scope of business to Europe, Japan and emerging markets. After establishing the core business markets discussed earlier, **iviewit** intends to expand into any market **iviewit** technology will benefit, i.e. the medical imaging industry.

iviewit's initial core businesses will be:

- 3-D sales & resale's of real-estate
- 3-D sales & resale's of high end luxury items

- **Interactive Employment Services**
- **Employer Search**
- **Modeling Agency**
- **Casting Agency**
- **3-D on line booking of hotel and resorts and related travel services**
- **Online live dating & personal ads**
- **Design, setup, implementation and management of 3-D sites**
- **Corporate advertising**
- **Banner Advertising**
- **Corporate Internet Alliances**
 - PROACTIVE email marketing packages



**PARTIAL LIST OF RESPONDENT'S INVENTIONS AFTER MEETING
COMPANY**

Filing Date	Patent No.	Title	Inventor
PATENTS ISSUED			
December 31, 1999	6,283,761	Apparatus and method for processing and/or for providing healthcare information and/or healthcare-related information	Joao, Raymond Anthony
PATENTS PENDING			
September 12, 2002	20020128922	Apparatus and method for selling a ticket to an event and/or to a portion of an event or venue	Joao, Raymond Anthony
February 5, 2002	20020108125	Apparatus and method for facilitating viewer or listener interaction	Joao, Raymond Anthony
January 22, 2002	20020099567	Apparatus and method for providing shipment information	Joao, Raymond Anthony
January 15, 2002	20020095360	Apparatus and method for providing transaction history information, account history information, and/or charge-back information	Joao, Raymond Anthony
January 2, 2002	20020087409	Apparatus and method for providing marketing, advertising, and/or promotional, materials with account billing and/or account statement information	Joao, Raymond Anthony
November 20, 2001	20020032586	Apparatus and method for providing insurance products, services and/or coverage for leased entities	Joao, Raymond Anthony
November 14, 2001	20020032583	Apparatus and method for processing and/or for providing healthcare information and/or healthcare-related information	Joao, Raymond Anthony
October 9, 2001	20020046191	Apparatus and method for providing transaction cost information	Joao, Raymond Anthony
September 17, 2001	20020038424	Apparatus and method for providing security for electronic signatures	Joao, Raymond Anthony; et al.
September 10, 2001	20020025797	Transaction security apparatus and method	Joao, Raymond Anthony; et al.
August 25, 2001	20020029163	Apparatus and method for providing campaign information, campaign-related information and/or election information	Joao, Raymond Anthony
July 31, 2001	20020016655	Apparatus and method for processing and/or for providing vehicle information and/or vehicle maintenance information	Joao, Raymond Anthony
June 21, 2001	20010056374	Apparatus and method for providing compensation for advertisement viewing and/or participation and/or for survey participation	Joao, Raymond Anthony
June 6, 2001	20010051920	Financial transaction and/or wireless communication device authorization, notification and/or security apparatus and method	Joao, Raymond Anthony; et al.
December 15, 2000	20010032099	Apparatus and method for processing and/or for providing healthcare information and/or healthcare-related information	Joao, Raymond Anthony



EXHIBIT H



RESPONDENT'S POSITIONING BETWEEN COMPANY AND END USERS²⁷

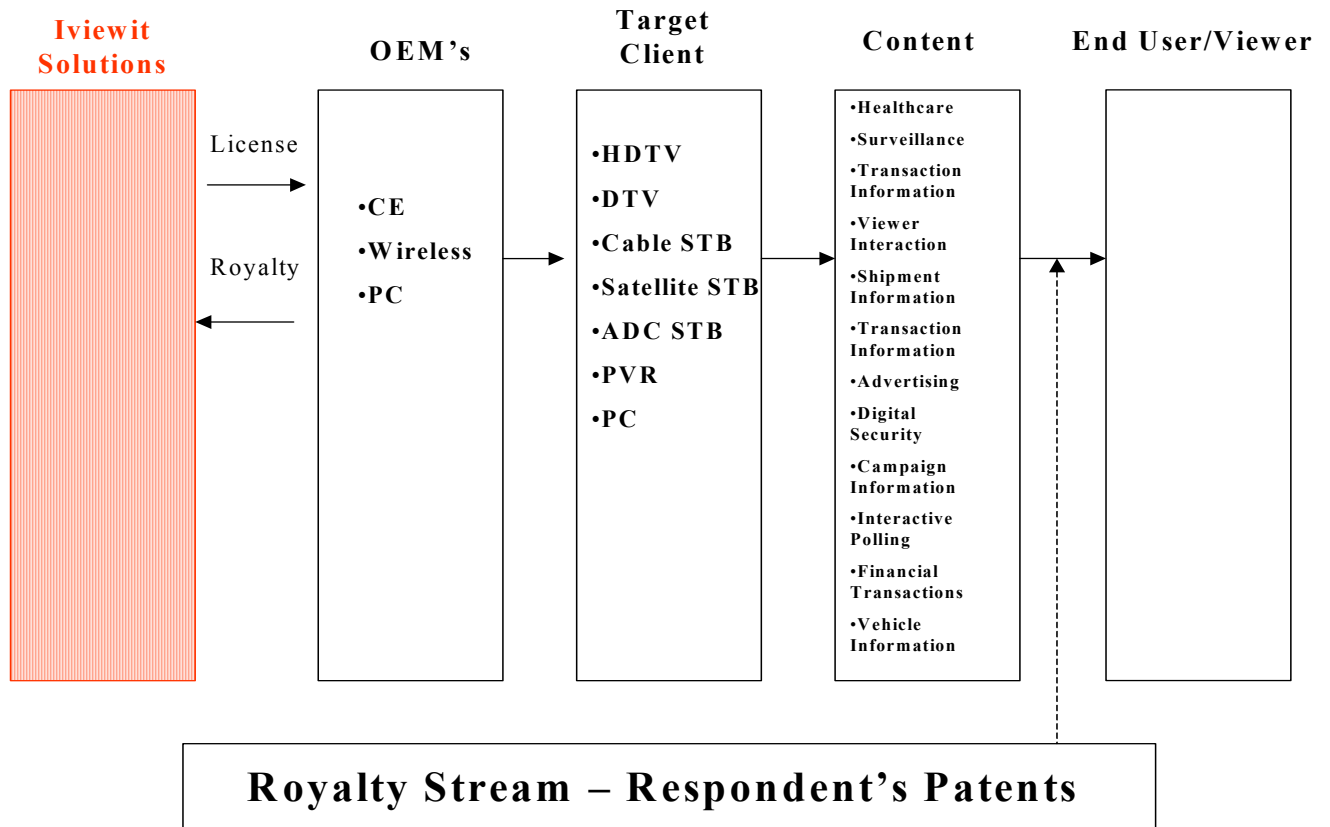

²⁷ To the best of the Company's ability, and based on limited information, as some of Respondent's inventions have yet to be published; the Company reiterates its request for Respondent to come forth with all of his patent filings during the period of engagement with the Company, from 1998 to the present.



EXHIBIT I



MLGS ENGAGEMENT AGREEMENT

TRANSMIT REPORT

1999-03-15 12:51

COM No.	REMOTE STATION	START TIME	DURATION	PAGES	RESULT	USER ID	REMARKS
873	EIS	03-15 12:50	01:05	03/03	OK		

7499603366

LAW OFFICES
MELTZER, LIPPE, GOLDSTEIN, WOLF & SCHLISSEL, P.C.
THE CHANCERY
190 WILLIS AVENUE
MINEOLA, NEW YORK 11501
(516) 747-0300

6V F-6
143

DATE: March 15, 1999 TIME: 11:59am

Telecopier Message From:
Raymond A. Joao

of Meltzer, Lippe, Goldstein, Wolf & Schissel, P.C.

Please deliver the following pages to:

NAME:	MR. ELIOT BERNSTEIN
FAX NUMBER:	561-417-4470
NUMBER OF PAGES, INCLUDING THIS COVER PAGE:	3
COMMENTS/INSTRUCTIONS:	<p>Per our discussion, attached herewith please find an Engagement Agreement.</p> <p>Please read the agreement thoroughly, and, if is satisfactory to you, please sign it and return to us along with a check.</p> <p>If you have any questions regarding the above, please do not hesitate to contact me.</p> <p>-RAYMOND A. JOAO</p>

Transmitted from a Faxmate 733 Digital Facsimile Transceiver. The FAX number is (516) 747-9363. If you do not receive all of the pages, please call us back as soon as possible at (516) 747-0300, extension 247.



received Event (Event Succeeded)

Date: 3/15/99
Pages: 3
Sender:
Fax Number:
Type: Fax

Time: 12:20 PM
Duration: 1 min 11 sec
Company:
Subject:

FROM:

1999-03-15 12:51 8673 P.02/03

LAW OFFICES
MELTZER, LIPPE, GOLDSTEIN, WOLF & SCHLISSEL, P.C.

180 WALL ST AVENUE, MINNEOLA, NY 11801

TELEPHONE: (614) 747-0300

FACSIMILE: (614) 747-0888

INTERNET: http://www.mlg.com

RICHARD A. LIPPE
ERDMAN H. GOLDSTEIN
LEAH S. WOLFE
CHARLES A. WOLF
ALAN L. WITTMAN
BRUCE S. CONNOR
JOSEPH SATO
DAVID J. HENNINGER
FRANCO CASARELLI
STEPHEN H. SCHLISSEL

WALTER H. BASTIENNE
ARON D. BLOOM
ACTING MANAGING PARTNER, NY
ELLEN HANAUER
JENNIFER M. GARDNER
THOMAS J. HARRISON
MICHAEL J. HOFFMAN
JONATHAN M. HOFFMAN
ALAN GOLDSTEIN
ALAN C. GARDNER
JEFFREY A. SELLON

COLLEGE
WILLIAM D. GIBSON, M.D.
MICHAEL YAMCHIK BLUM

ROBERT J. PALMER

JONATHAN B. FINELLI
JEFFREY A. FLEISCHMAN
MICHAEL D. HORN
LAURA S. BRADY

GREG LUCIER
PHILIP J. COOPER, JR.
JENNIFER S. HORNBERGER
ETIENNE TABAK

ENGAGEMENT AGREEMENT

March 15, 1999

PLEASE REFER TO MINNEOLA
NEW YORK
340 EAST 43RD STREET
NEW YORK, NY 10017
TELEPHONE: (212) 684-8800
BUFFALO
110 LAKE AVENUE SOUTH SUITE 400
ROCHESTER, NY 11807
TELEPHONE: (716) 233-0000
FAX: (716) 233-0000
WWW.MLG.COM

ALSO ADMITTED IN:
NY
NJ
DC

NY & CT
NY & NJ

EV 143

VIA TELEFAX 561-417-4470
Mr. Eliot Bernstein
iVIEWIT
500 S.E. Mizner Road
Suite 102
Boca Raton, Florida 33432

Dear Mr. Bernstein:

You have requested that Meltzer, Lippe, Goldstein, Wolf & Schlissel, P.C. (hereinafter "the Firm") prepare a Provisional Patent Application on your behalf.

You hereby agree and understand that the Firm's representation of you will be performed pursuant to a written engagement letter and that subsequent work will be performed pursuant to future agreements if, as, and when, they may be entered into.

You agree and understand that the Firm's representation of you will consist of preparing and filing a Provisional Patent Application which will provide "patent pending" status for one year from its filing date. The Provisional Patent Application will not be examined by the U.S. Patent & Trademark Office, but will only serve to let you obtain a priority filing date in the U.S. In order to pursue a U.S. Patent, you must file a subsequent patent application within one year from your Provisional Application filing date. Unless specifically retained by written agreement to do so, this Firm will have no responsibility for filing any subsequent application(s) and/or taking any other steps on your behalf, aside from forwarding the Provisional Application Filing Receipt to you.



Event (Event Succeeded)

3/15/99 Time: 12:20 PM
 3 Duration: 1 min 11 sec
 Sender: Company:
 Fax Number: Subject:
 Type: Fax

FROM: 1999-03-15 12:51 #973 P.03/03

MELTZER, LIPPE, GOLDSTEIN, WOLF & SCHLISSEL, P.C.
 Mr. Elliot Bernstein
 IVIEWIT
 Page 2

Our fee for preparing a Provisional Application will be \$3,000, the Official filing fee will be either \$150 or \$75 depending on your filing status, and postage fees, copying charges and phone charges will be additional. Our efforts in preparing the Provisional Patent Application will be limited to drafting the application from a single disclosure provided by yourself which includes all of the information which you wish to have covered in the application.

Our \$3,000 fee will include 10 hours of work, including time spent to date, at an hourly rate of \$300/hour. Raymond A. Joao will prepare the application for you. This estimate has been arrived at after reviewing information received from you to date. If, however, the supplied disclosure is drastically different from that originally supplied, we reserve the right to renegotiate our fee before commencing work.

If this agreement is satisfactory to you, please sign at the appropriate location and return same to us along with the invention disclosure, and a check in the amount of \$3,200 which includes payment for the above along with a \$50 retainer for postage, copy charges and phone charges. Upon receiving all of the above, we will commence work on these matters.

If you wish to wire funds to our Firm, please follow the directions below:

Please wire U.S. dollars to :

EUROPEAN AMERICAN BANK
 MELTZER, LIPPE, GOLDSTEIN, WOLF AND SCHLISSEL
 OPERATING ACCOUNT

ACCOUNT NUMBER: 064-07111-1
 BANK A.B.A. NUMBER: 021-001486

CONTACT PERSON: FRANK MARK OR DEBORAH ANTONUCCI

THIS ENGAGEMENT AGREEMENT IS
 ENTERED INTO THIS 15 DAY
 OF March, 1999 .

 Elliot Bernstein

MELTZER, LIPPE, GOLDSTEIN,
 WOLF & SCHLISSEL, P.C.
 By: Raymond A. Joao

020001\bernstel\prowapp.doc



Aug 10 1999 05:02p

Eliot Bernstein

561-417-4470

p.3

AUG 10 1999 16:41 FR PROSKAUER ROSE

561 241 5288 TO 04884E017001841 P.04/27

LAW OFFICES
MELTZER, LIPPE, GOLDSTEIN & SCHLISSEL, P.C.

100 WALLIE AVENUE, MIAMI, FL 33130

TELEPHONE: (305) 342-4300

FACSIMILE: (305) 342-0822

INTERNET: www.mlg.com

RICHARD J. LIPPE	THOMAS J. GOLDSTEIN
ANDREW H. MELTZER	ANDREW H. MELTZER
LEAH S. WOLFE	LEAH S. WOLFE
CHRISTOPHER S. BASH	CHRISTOPHER S. BASH
DAVID L. SCHLISSEL	DAVID L. SCHLISSEL
FRANK J. SCHLES	FRANK J. SCHLES
DAVID J. SCHLES	DAVID J. SCHLES
DAVID J. SCHLES	DAVID J. SCHLES
DAVID J. SCHLES	DAVID J. SCHLES
DAVID J. SCHLES	DAVID J. SCHLES
DAVID J. SCHLES	DAVID J. SCHLES

11000 BUCKLE RD MIAMI
MIAMI FL 33156
11000 BUCKLE RD MIAMI
MIAMI FL 33156
11000 BUCKLE RD MIAMI
MIAMI FL 33156

[ENGAGEMENT AGREEMENT]

REYNOLD S. PROSKAUER	REYNOLD S. PROSKAUER
REYNOLD S. PROSKAUER	REYNOLD S. PROSKAUER
REYNOLD S. PROSKAUER	REYNOLD S. PROSKAUER
REYNOLD S. PROSKAUER	REYNOLD S. PROSKAUER
REYNOLD S. PROSKAUER	REYNOLD S. PROSKAUER

JOHNATHAN S. RABINOVITZ	JOHNATHAN S. RABINOVITZ
JOHNATHAN S. RABINOVITZ	JOHNATHAN S. RABINOVITZ
JOHNATHAN S. RABINOVITZ	JOHNATHAN S. RABINOVITZ
JOHNATHAN S. RABINOVITZ	JOHNATHAN S. RABINOVITZ
JOHNATHAN S. RABINOVITZ	JOHNATHAN S. RABINOVITZ

August 4, 1999

VIA TELEFAX 561-241-7145
Stuart Kapp, Esq.
Proskauer Rose, LLP
2255 Glades Road
Boca Raton, FL 33431-7360

Re: General Intellectual Property Matters,
including but not limited to counsel, drafting,
preparation and filing of Patent Applications

Dear Mr. Bernstein:

iviewit LLC has requested that Meltzer, Lippe, Goldstein & Schlissel, P.C. represent iviewit LLC in general patent and intellectual property matters. Our patent and intellectual property fees will be based on an hourly rate of \$300.00 per hour and will be handled by Raymond A. Joao. The above legal fees do not include disbursements and expenses.

iviewit LLC is to pay us an additional retainer of \$3,000, in addition to satisfying all outstanding balances to date, which, as of August 4, 1999 is \$8,548.04. Our firm has an intake committee which must approve the terms of iviewit LLC's engagement of us. If the Committee does not accept the terms of the engagement and we are unable to agree upon revised terms, any unused funds will be returned to iviewit LLC.

iviewit LLC agrees that our invoices will be paid within twenty (20) days of the billing date stated on each invoice and

AUG 06 1999 16:53

PAGE 02



Aug 10 99 05:02p El 'nt Bernstein 507-417-4470 p. 4
AUG 10 1999 16:41 FR PROSKAUER ROSE 561 241 5280 TO 0488848017081841 P.05-27

MELTZER, LIPPE, GOLDSTEIN & SCHLISSEL, P.C.

that any past due amounts will accrue late charges (the rate is 1 1/2% per month and is subject to change by us), calculated from the original invoice date.

iViewit LLC and the firm are agreeing to a Credit Limit for iViewit LLC's matters. The credit limit is \$3,000. If at any time, the aggregate of (i) all outstanding bills rendered to iViewit LLC which are unpaid and (ii) the value of all unbilled time for services rendered by the Firm and the amount of all unbilled disbursements incurred in connection therewith, exceeds the Credit Limit iViewit LLC will be promptly notified that iViewit LLC's account has exceeded the credit limit. When iViewit LLC has exceeded the Credit Limit, we will call iViewit LLC and ask for an immediate payment. iViewit LLC agrees to make an immediate payment to bring iViewit LLC's account well under the Credit Limit.

In the event that any bills rendered by the Firm are not paid when due, iViewit LLC hereby consents to our (i) immediately ceasing any and all work being performed by us for iViewit LLC's account and/or (ii) our withdrawal from any further representation of iViewit LLC.

In the event of any dispute arising out of or relating to this agreement and/or the legal services rendered hereunder, the same shall be determined by binding arbitration in Nassau County, Long Island, New York, by an arbitrator chosen by the President of the Nassau County Bar Association who has significant experience in the field in which the legal services were rendered.

The Miscellaneous Rules attached hereto form a part of this Agreement.

We look forward to serving iViewit LLC's legal needs and thank you for retaining our Firm.

THIS ENGAGEMENT AGREEMENT IS
ENTERED INTO THIS ___ DAY
OF _____, 199 .

iViewit LLC
By: [Signature]
Print Name Shel Proskauer
Title: Secretary
Date: 8/10/99
Credit Limit \$3,000.00 SP (client initials)

MELTZER, LIPPE, GOLDSTEIN,
WOLF & SCHLISSEL, P.C.
By: _____



Aug 10 99 05:03p Elbert Bernstein SPN-417-4470 P.5
... RLG 10 1999 16:41 FR PROSKALER ROSE 561 241 5200 TO 8480H48017001R41 P.05/07

MELTZER, LEFF, GOLDSTEIN & SCHLISSEL, P.C.

MISCELLANEOUS RULES

1. If, at any time, either (i) iviewit LLC elects to terminate the engagement of the Firm or (ii) the Firm elects to withdraw from the engagement, any excess funds remaining over the charges incurred by the Firm prior to the termination of the engagement will be refunded to iviewit LLC.

2. The hourly rates are exclusive of disbursements and charges incurred by the Firm on iviewit LLC's behalf for such items as photocopies, word processing, computerized legal research, telecopying, messenger or overnight delivery service, long distance telephone charges, travel and, if applicable, filing fees and court costs, such as transcripts, index fees, etc. iviewit LLC will be billed separately for such disbursements.

Third-party disbursements are billed at 1.2 times actual cost. If iviewit LLC does not wish to pay 1.2 times for third-party disbursements, iviewit LLC may choose one of the following alternatives (please initial your selection):

I hereby elect to deposit with you \$_____ to be held in a separate account out of which you will pay third-party disbursements.

LLC
this

I request that you notify me each time a third-party disbursement must be paid and iviewit LLC will send you the appropriate check promptly upon receipt of your request. iviewit understands that iviewit LLC's selection of procedure is likely to cause delays in the handling of my matter and such delay may adversely impact my matter. iviewit LLC relieves the Firm of any responsibility for such delay.

3. The Firm will generally submit bills to iviewit LLC on a monthly basis, at which time iviewit LLC will also be provided with a summary of the work performed. In addition, we maintain at our office computer time and disbursement records, which will be available for iviewit LLC's inspection.

4. If the Firm is successful in any proceeding to recover any sum due to the Firm, iviewit LLC hereby agrees that



EXHIBIT J



**RESPONDENT'S 405 PATENT AND THE REMOTELY SIMILAR PATENT
WITHOUT VIDEO**



US005917405A

United States Patent [19]

[11] Patent Number: **5,917,405**

Joao

[45] Date of Patent: ***Jun. 29, 1999**

[54] CONTROL APPARATUS AND METHODS FOR VEHICLES

[76] Inventor: **Raymond Anthony Joao**, 122 Bellevue Pl., Yonkers, N.Y. 10703

[*] Notice: This patent issued on a continued prosecution application filed under 37 CFR 1.53(d), and is subject to the twenty year patent term provisions of 35 U.S.C. 154(a)(2).

[21] Appl. No.: **08/683,828**

[22] Filed: **Jul. 18, 1996**

5,113,427	5/1992	Ryoichi et al.	379/57
5,138,649	8/1992	Krisbergh et al.	379/56
5,173,932	12/1992	Johansson et al.	379/40
5,208,756	5/1993	Song	
5,223,844	6/1993	Mansell et al.	342/457
5,247,564	9/1993	Zicker	340/426
5,276,728	1/1994	Pagliarioli et al.	379/426
5,287,398	2/1994	Briault	379/38
5,334,974	8/1994	Simms et al.	342/457
5,389,935	2/1995	Drouault et al.	340/426
5,418,537	5/1995	Bird	342/457
5,432,841	7/1995	Rimer	379/59
5,513,244	4/1996	Joao et al.	379/58
5,515,043	5/1996	Berard et al.	340/426
5,557,254	9/1996	Johnson et al.	340/825.34
5,563,453	10/1996	Nyfelt	340/426
5,682,133	10/1997	Johnson et al.	340/426

Related U.S. Application Data

[63] Continuation-in-part of application No. 08/622,749, Mar. 27, 1996, and application No. 08/587,628, Jan. 17, 1996, abandoned, which is a continuation of application No. 08/489,238, Jun. 12, 1995, Pat. No. 5,513,244, which is a continuation of application No. 08/073,755, Jun. 8, 1993, abandoned.

- [51] Int. Cl.⁶ **B60R 25/10**
- [52] U.S. Cl. **340/426; 340/425.5; 340/825.32; 701/36; 307/10.2; 342/457; 455/404**
- [58] Field of Search **342/457; 340/426, 340/825.34, 825.32, 825.36, 825.37, 825.49, 425.5; 370/352, 389; 307/10.2; 455/404; 180/287; 701/33, 36**

[56] References Cited

U.S. PATENT DOCUMENTS

4,882,579	11/1989	Siwiak	340/825.44
4,882,746	11/1989	Shimada	379/61
5,003,317	3/1991	Gray et al.	
5,031,103	7/1991	Kamimura et al.	364/449
5,081,667	1/1992	Drori et al.	340/426

Primary Examiner—Michael Horabik
Assistant Examiner—Timothy Edwards, Jr.
Attorney, Agent, or Firm—Raymond A. Joao

[57] ABSTRACT

A control apparatus for a vehicle, which comprises a first control device. The first control device one of generates and transmits a first signal for one of activating, deactivating, enabling, and disabling, one of a vehicle component, a vehicle device, a vehicle system, and a vehicle subsystem. The first control device is located at the vehicle. The first control device is responsive to a second signal, wherein the second signal is one of generated by and transmitted from a second control device. The second control device is located at a location which is remote from the vehicle. The second control device is responsive to a third signal, wherein the third signal is one of generated by and transmitted from a third control device. The third control device is located at a location which is remote from the vehicle and remote from the second control device.

20 Claims, 20 Drawing Sheets

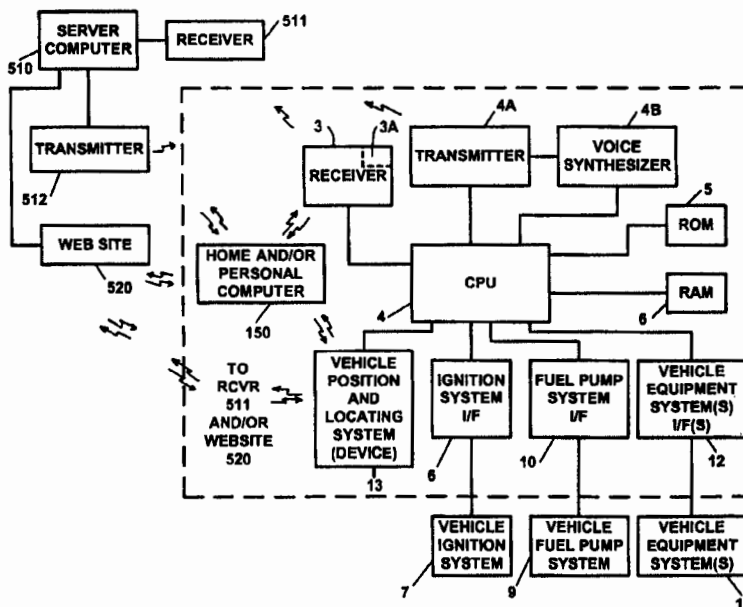

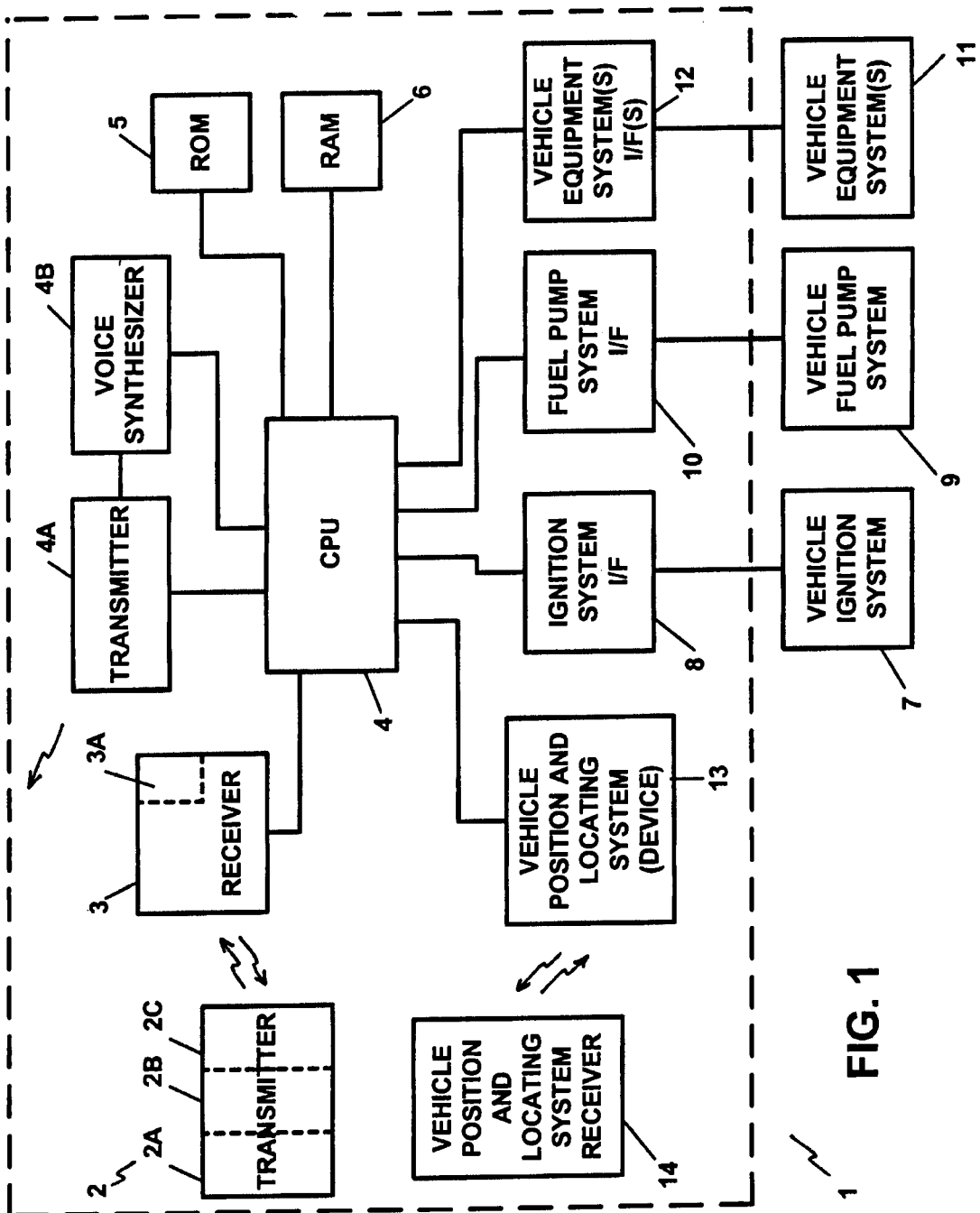

FIG. 1

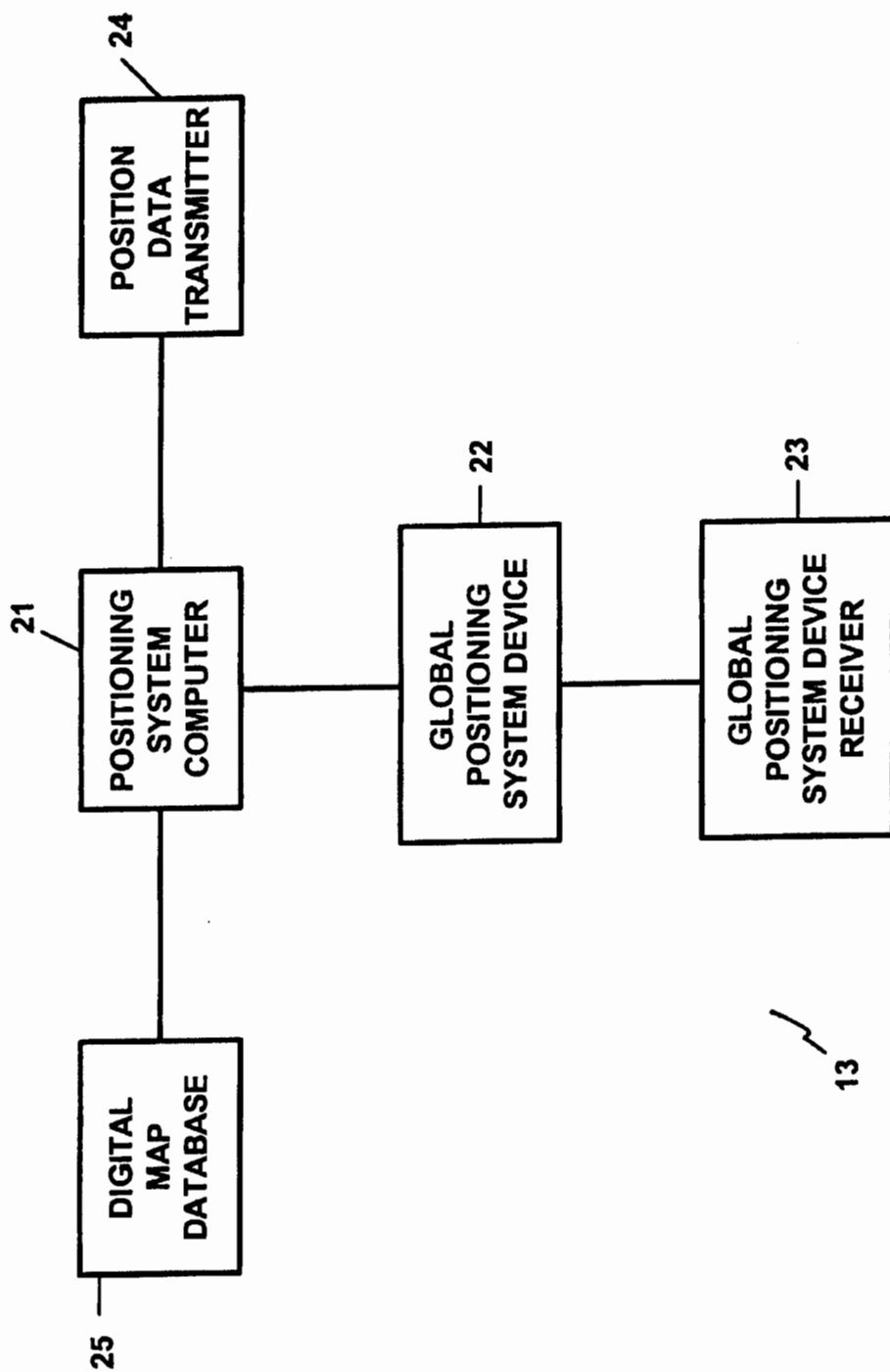

FIG. 2

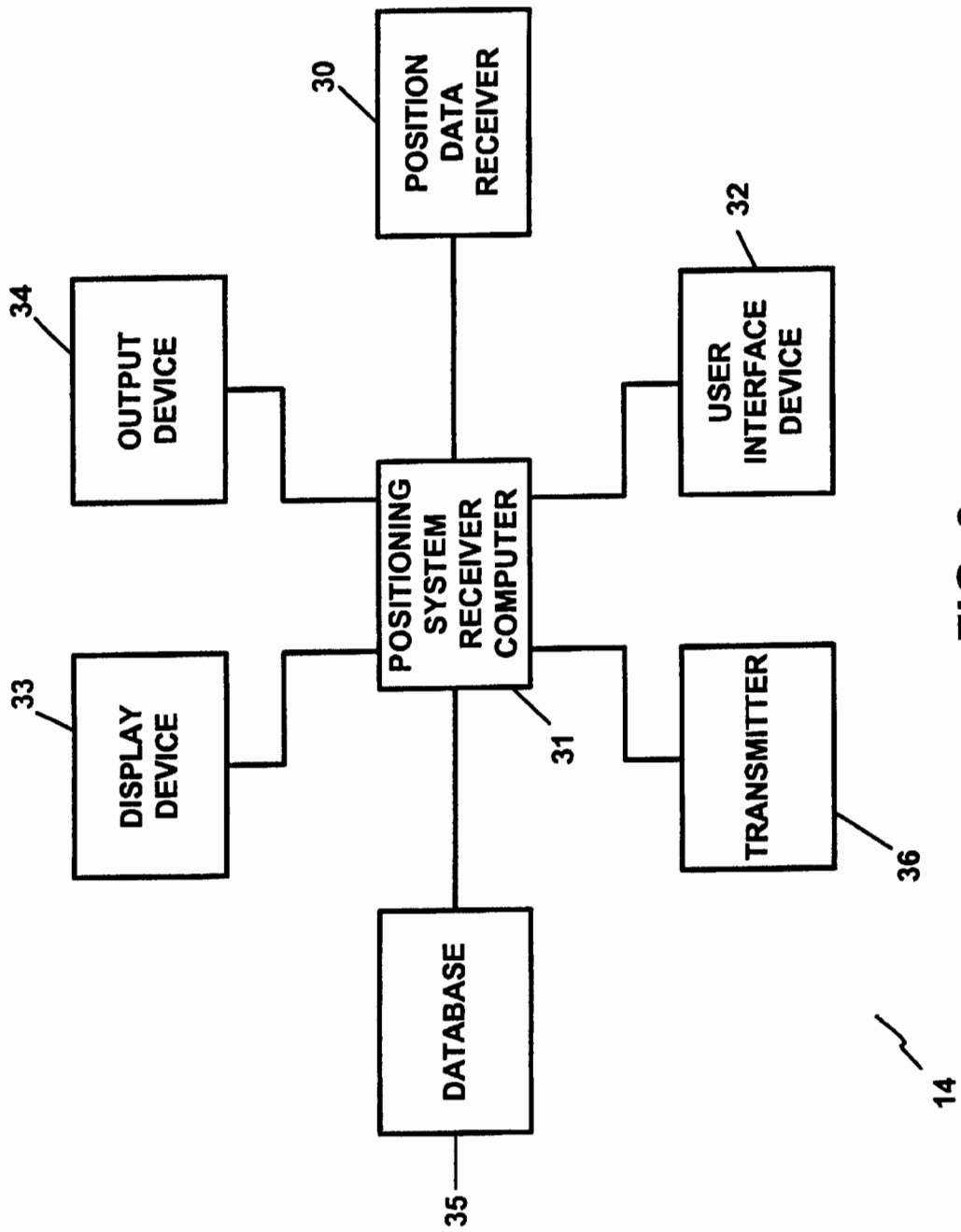

FIG. 3

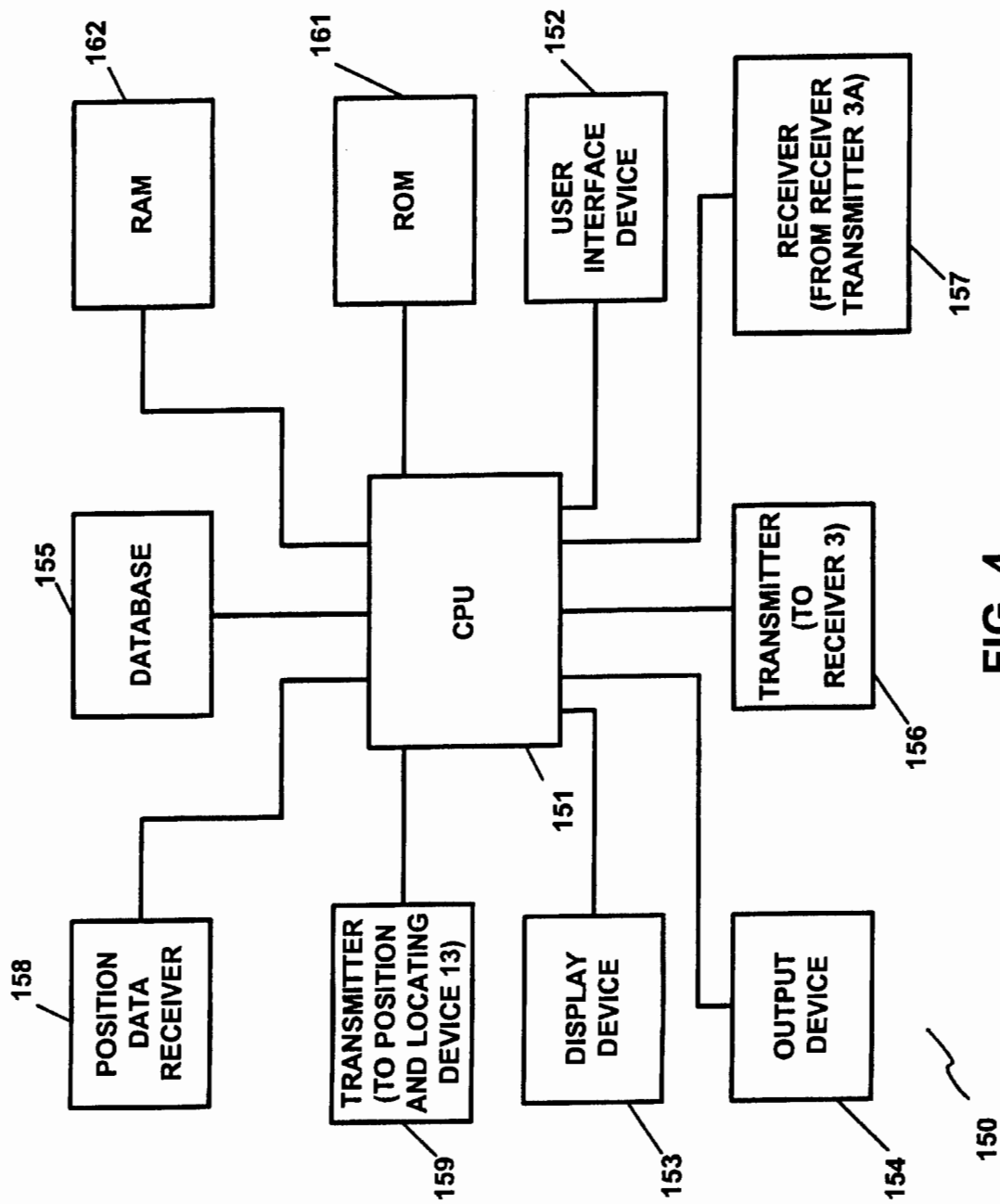

FIG. 4

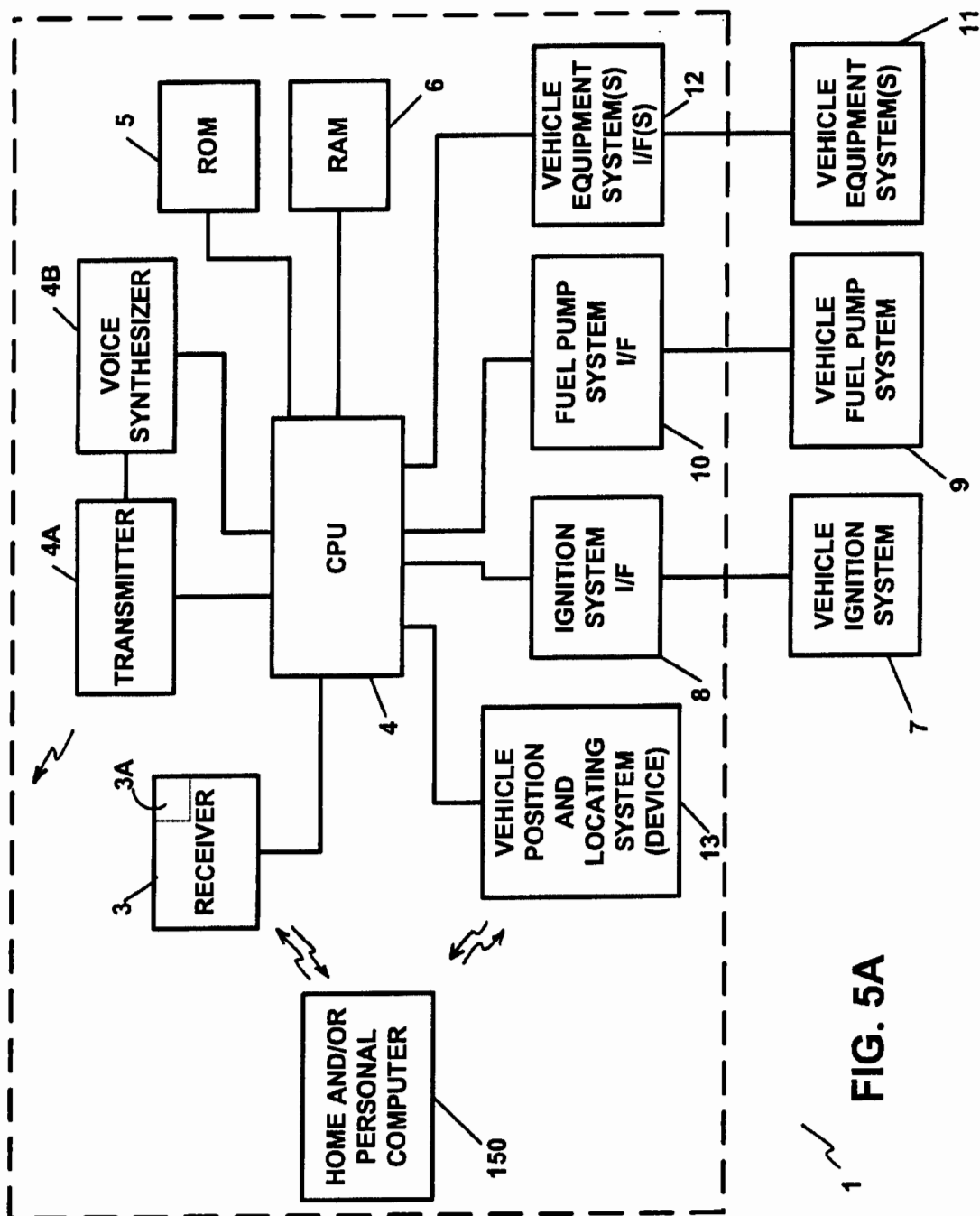
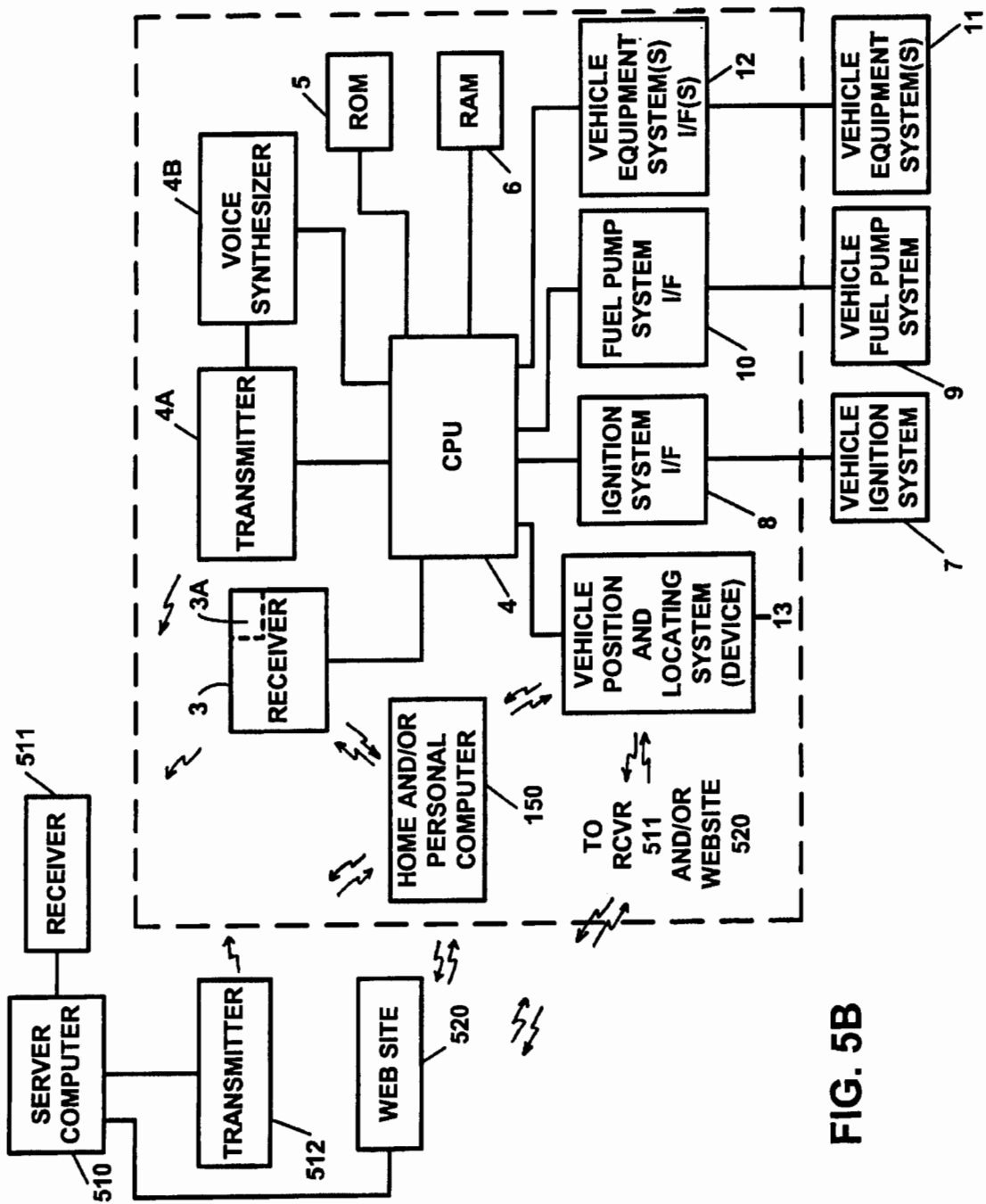

FIG. 5A



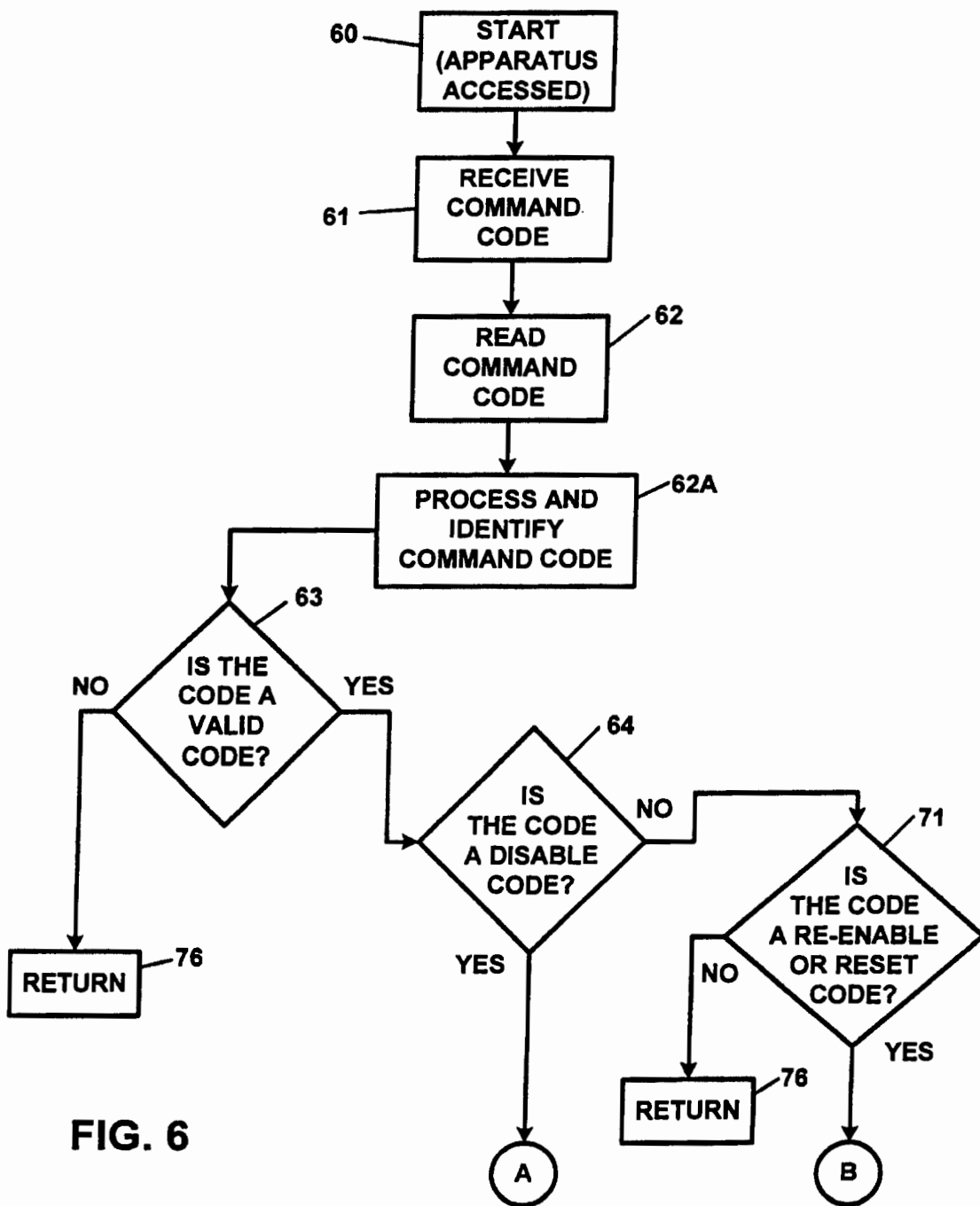

FIG. 6

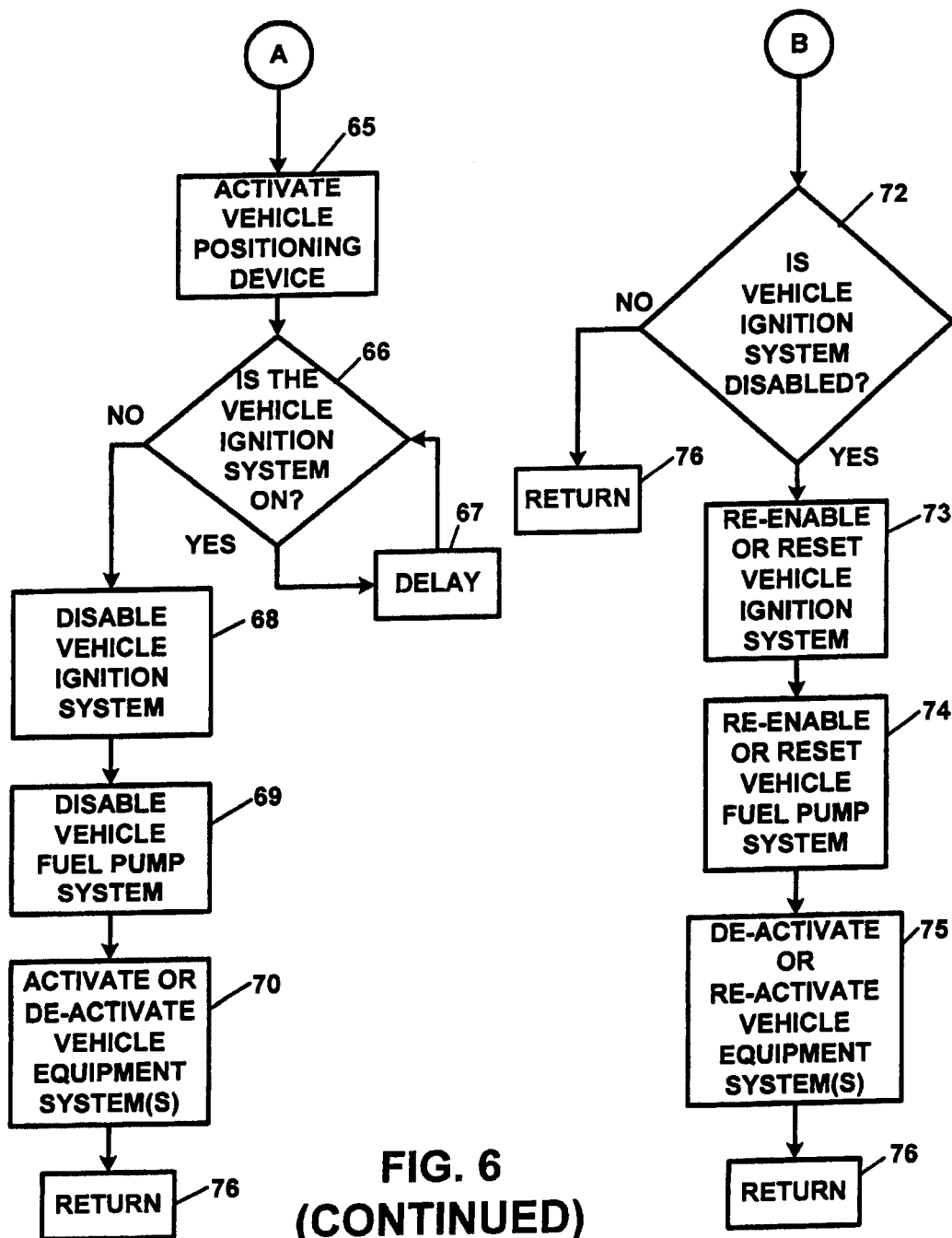

FIG. 6
(CONTINUED)

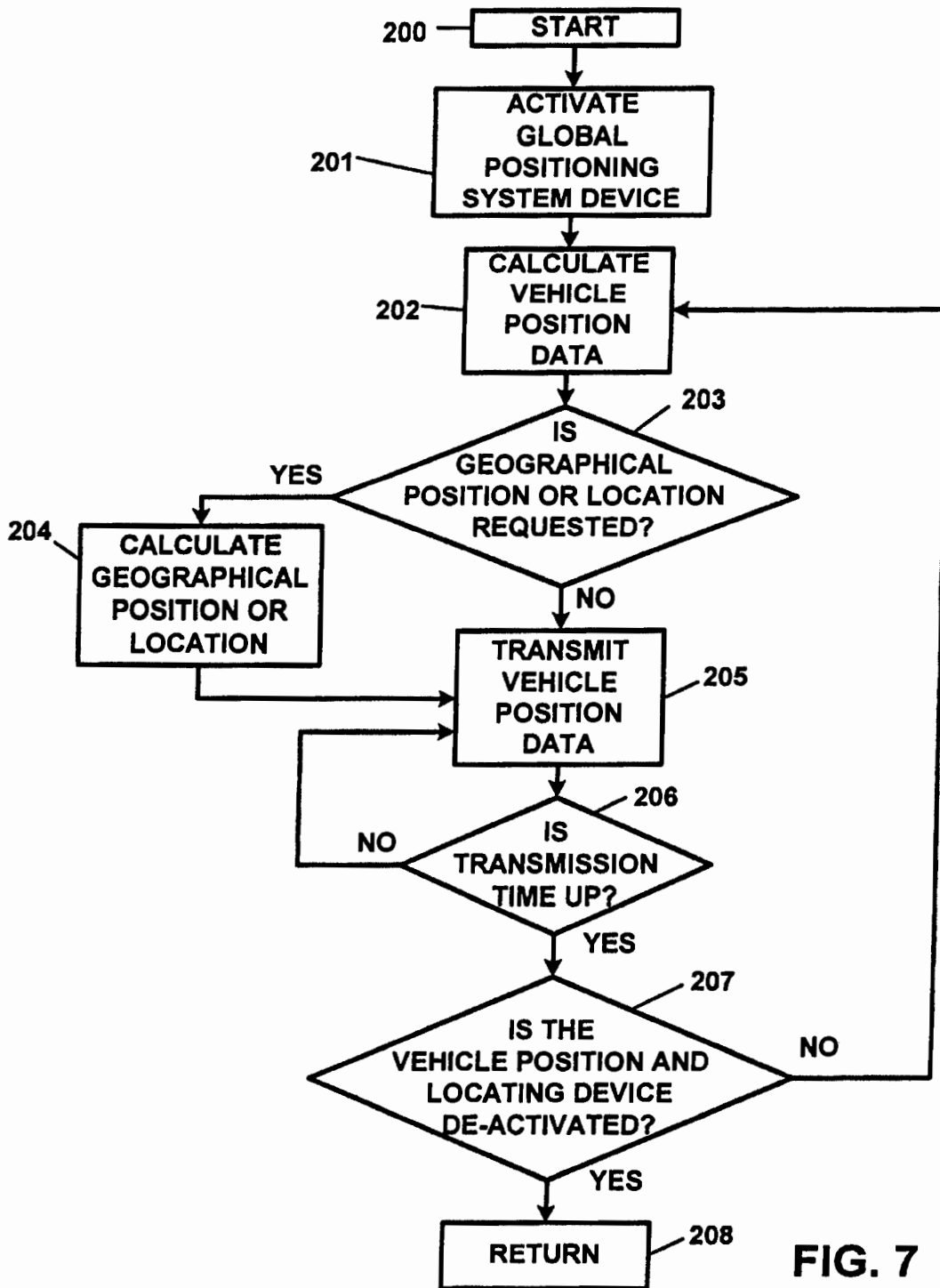

FIG. 7

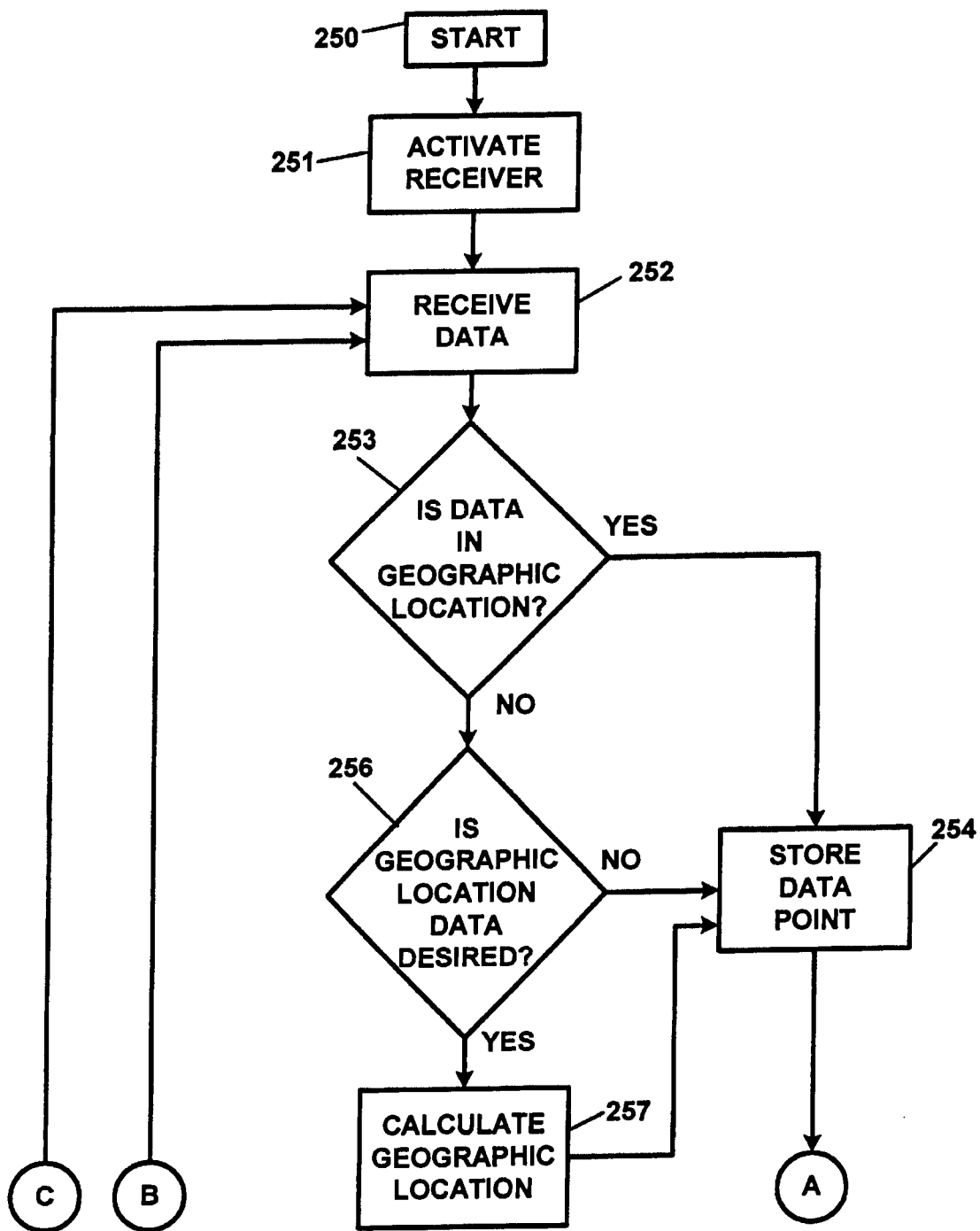

FIG. 8

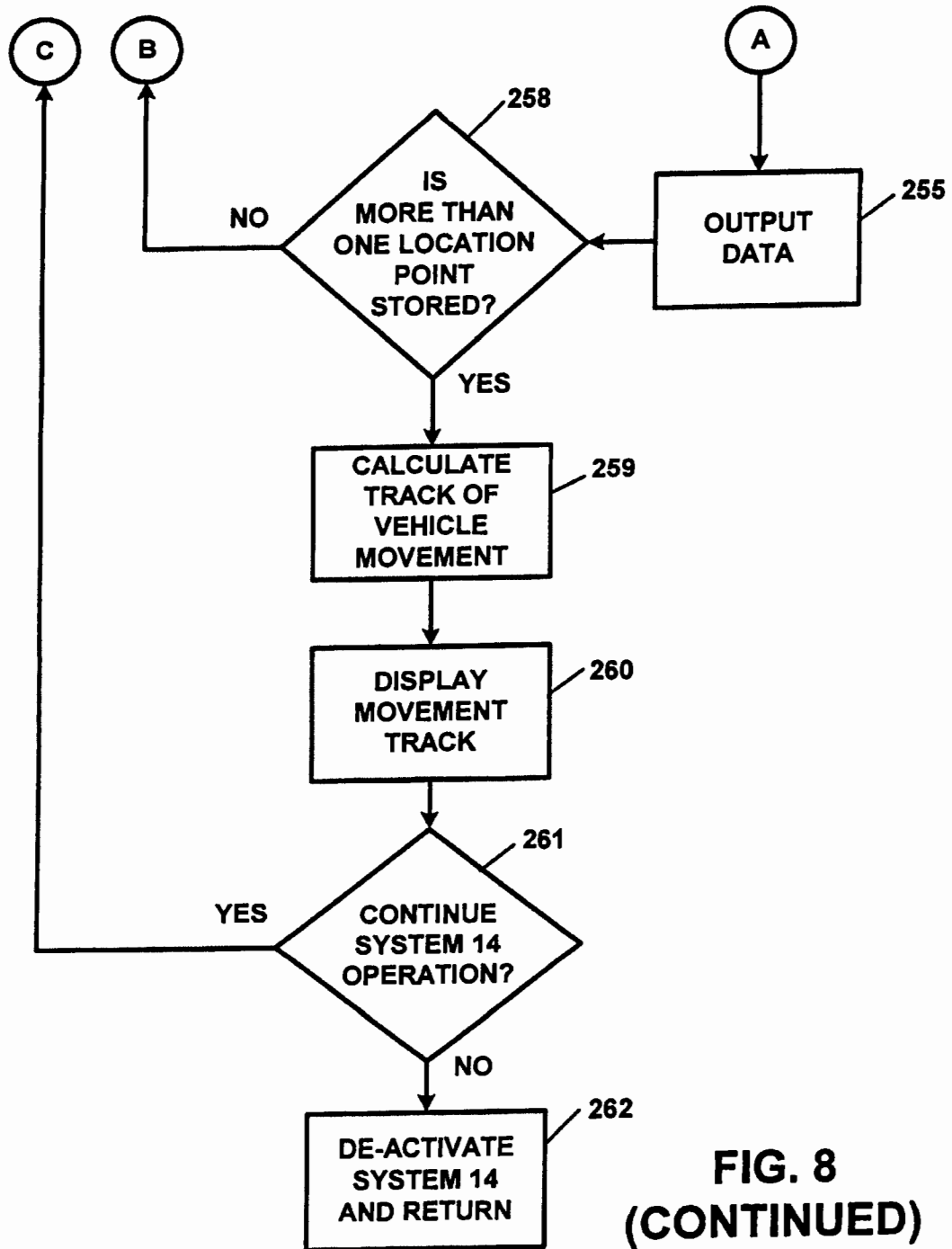

FIG. 8
(CONTINUED)

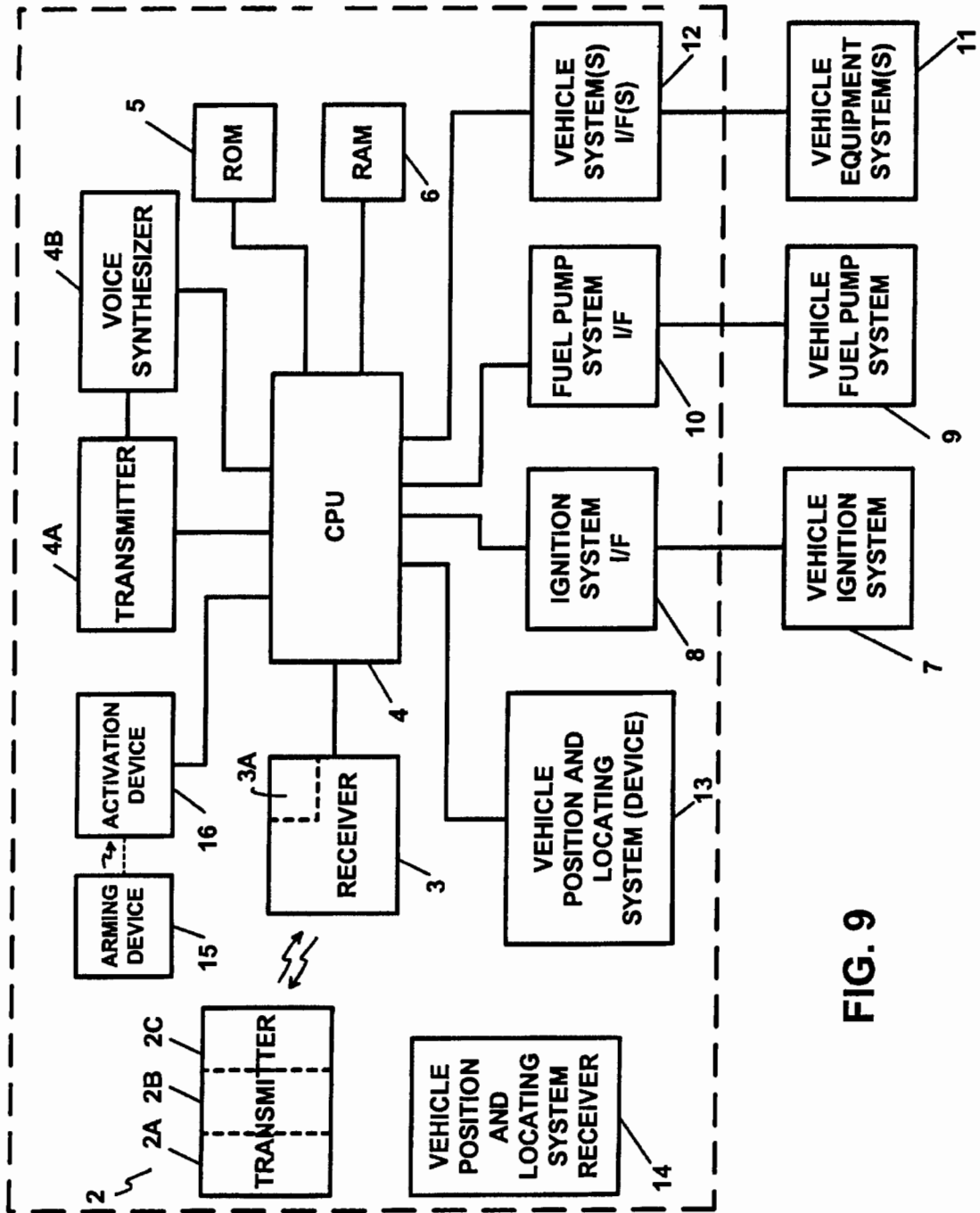

FIG. 9

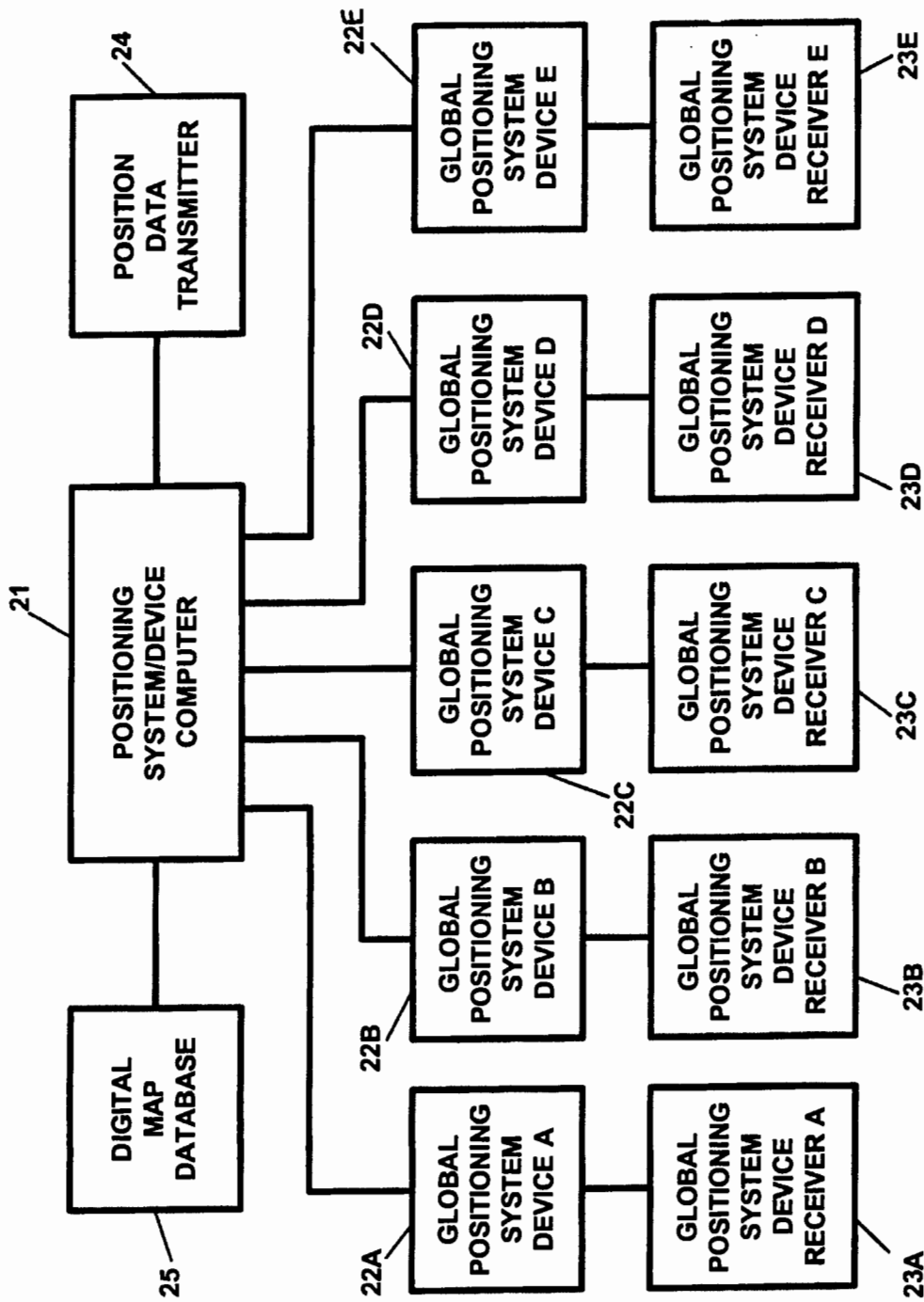

FIG. 10

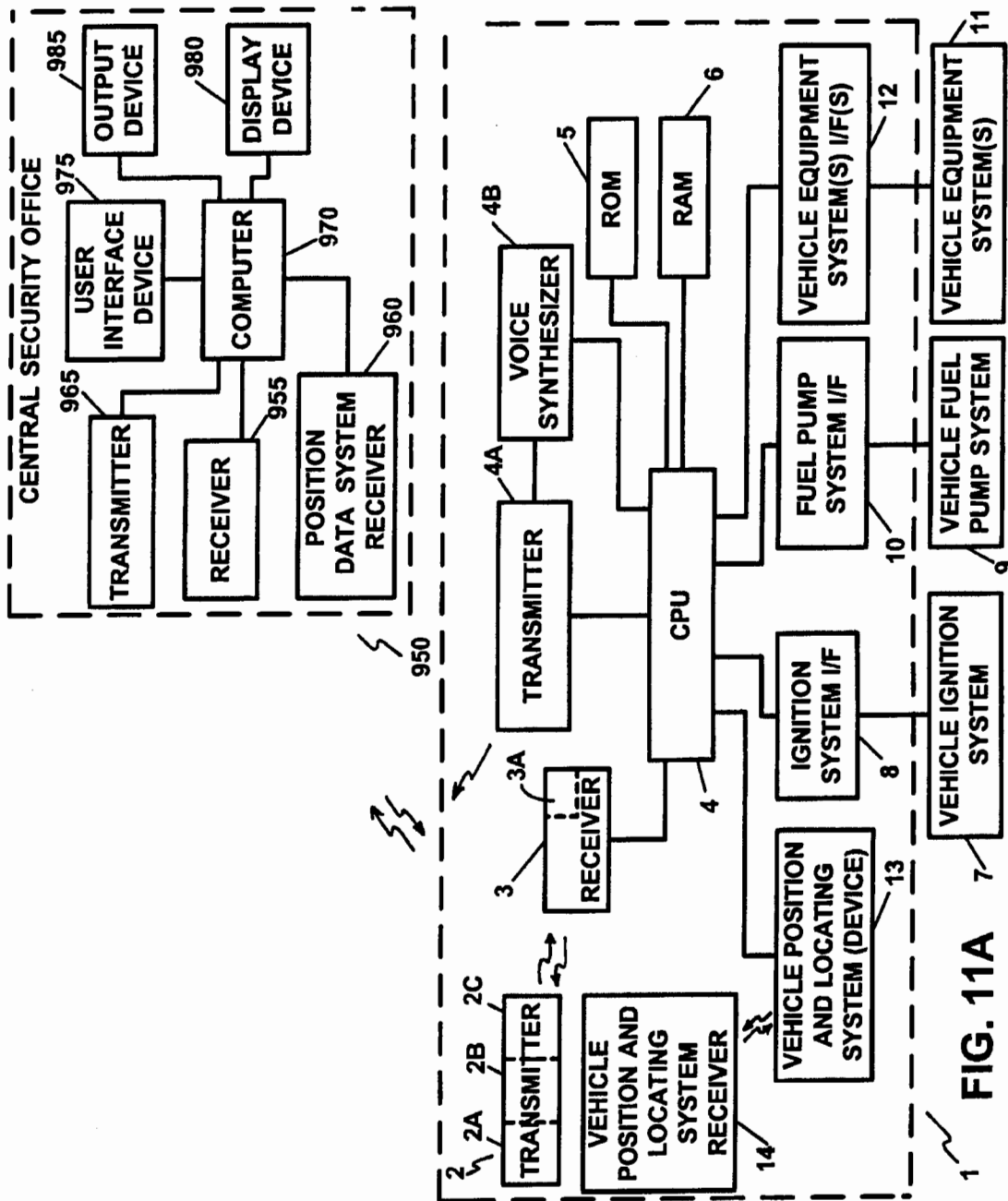

FIG. 11A

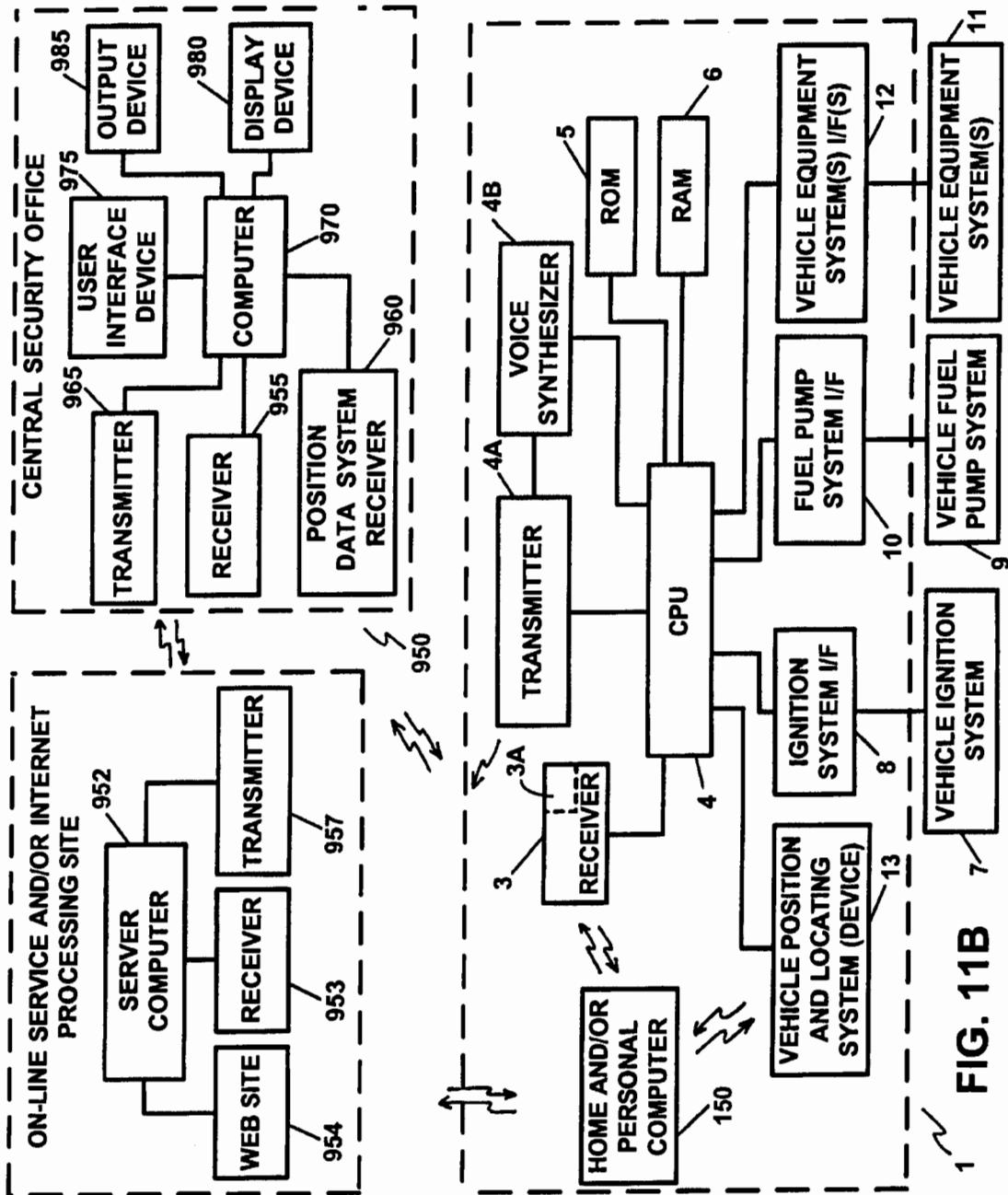

FIG. 11B

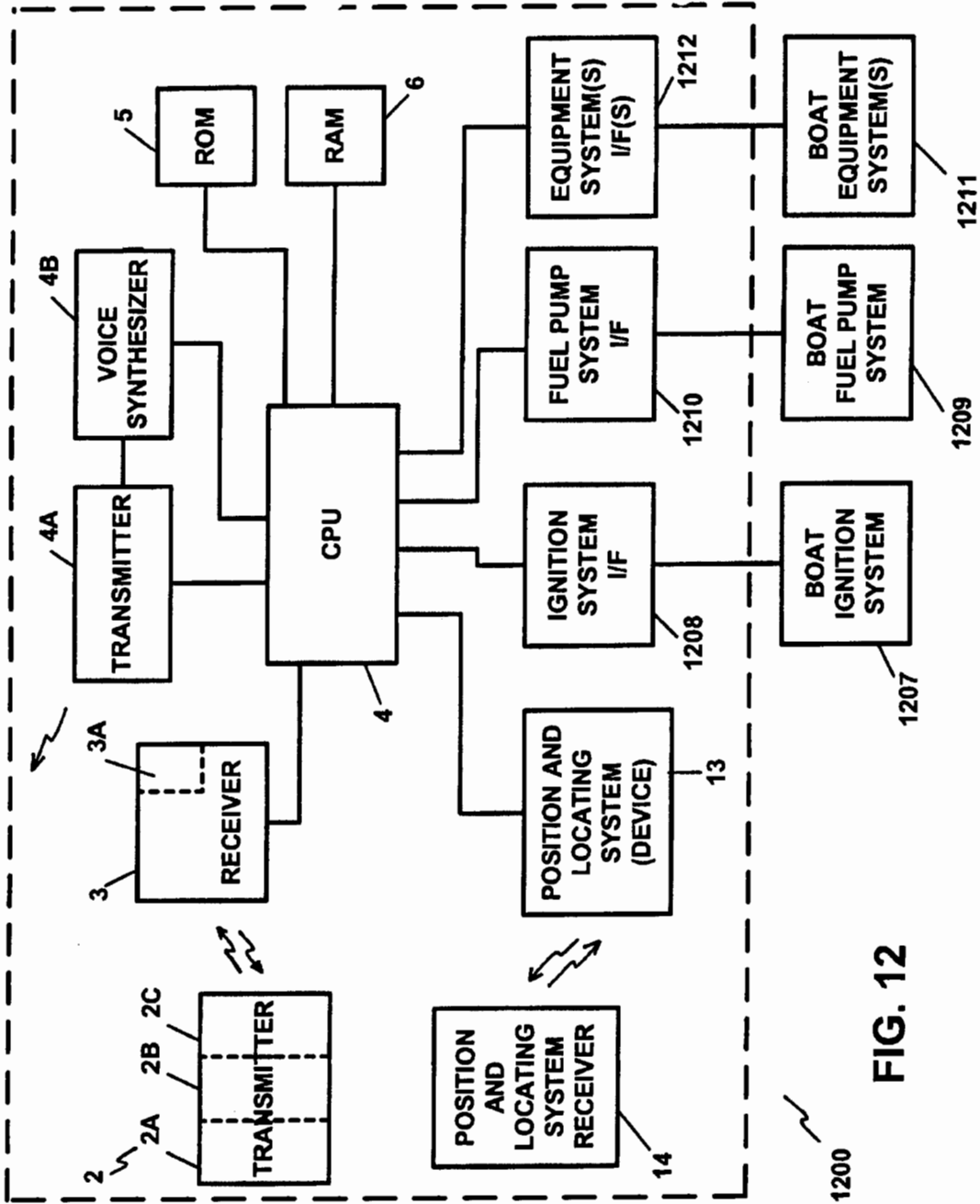

FIG. 12

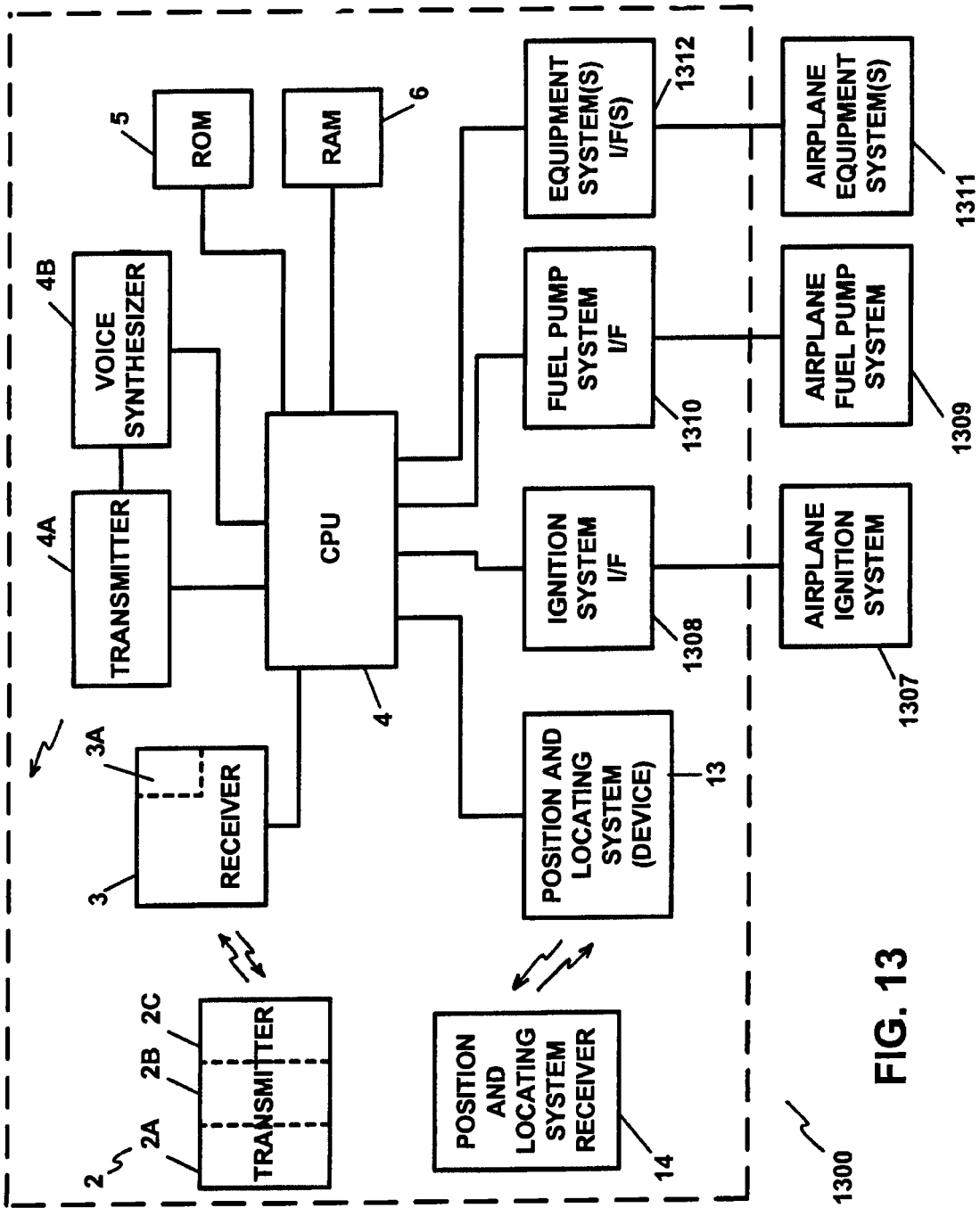

FIG. 13

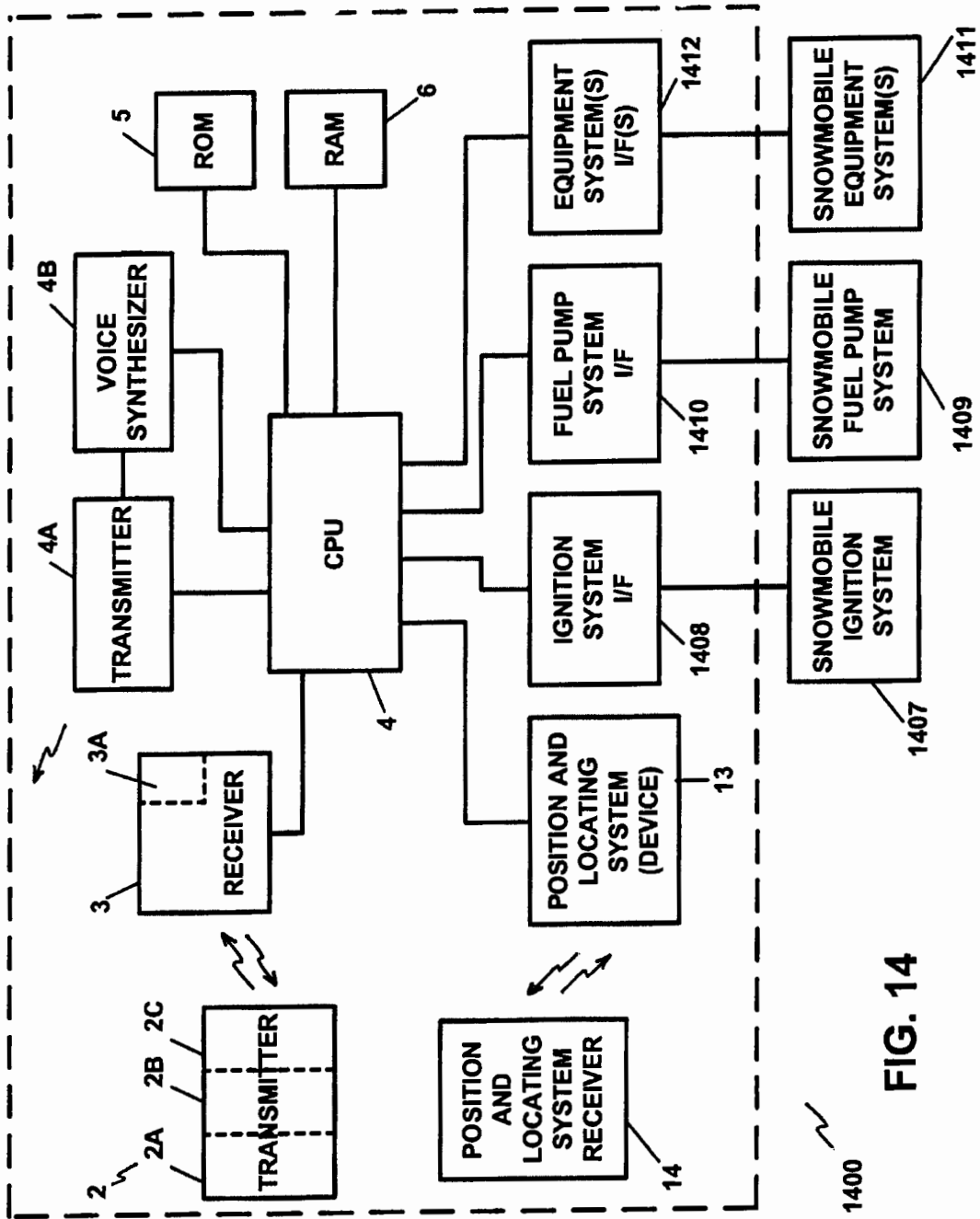

FIG. 14

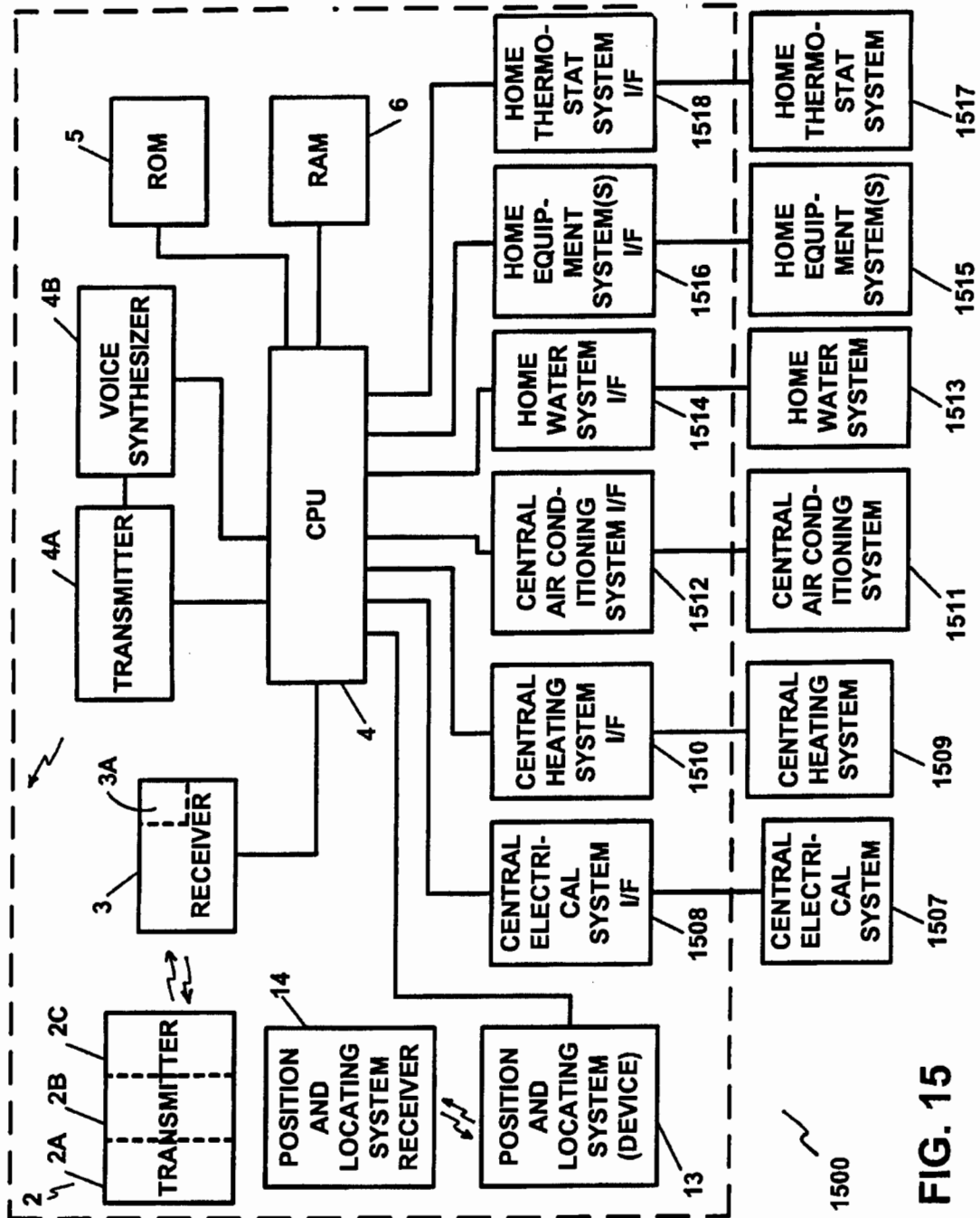

FIG. 15

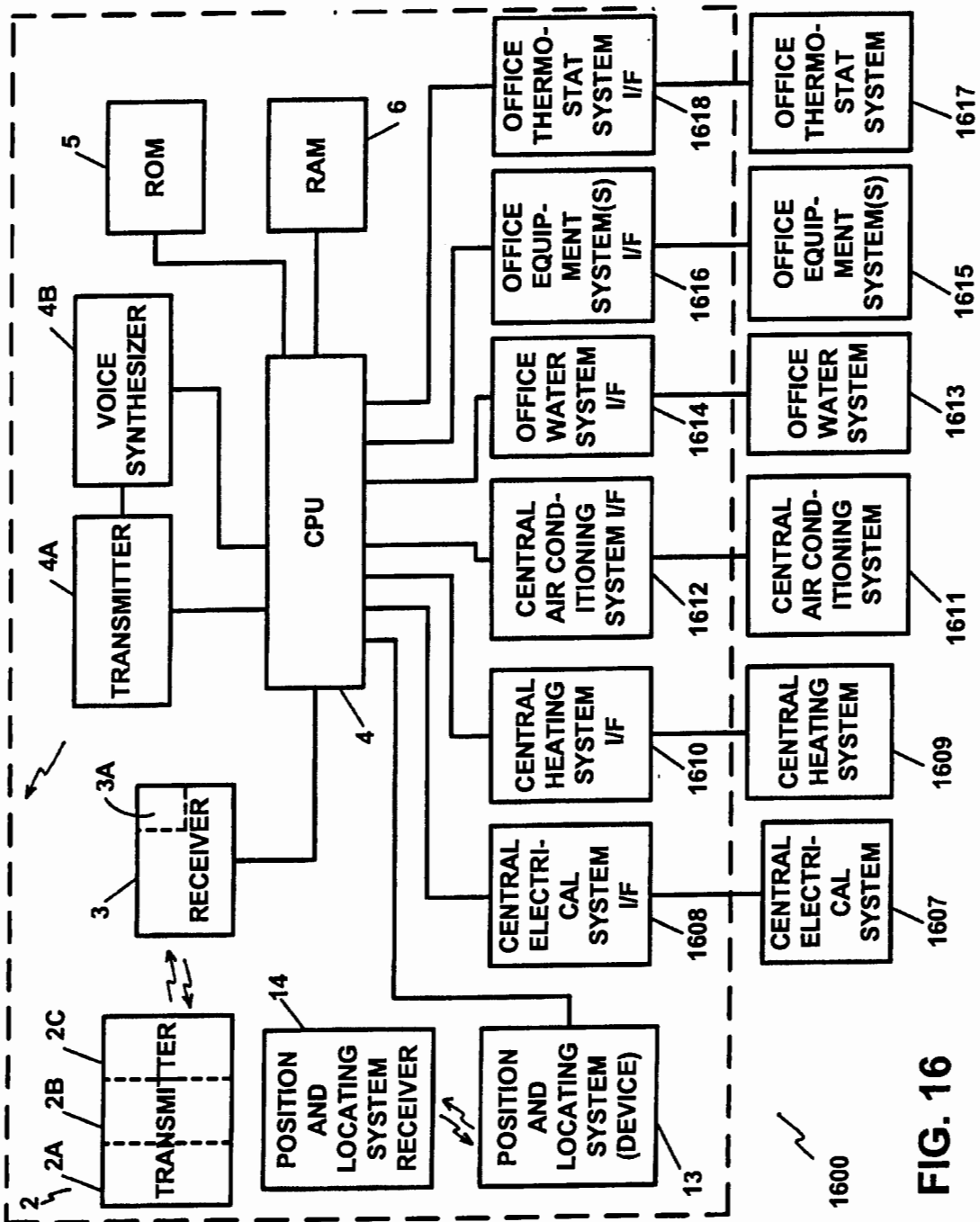

FIG. 16

CONTROL APPARATUS AND METHODS FOR VEHICLES

RELATED APPLICATIONS

This is a continuation-in-part application of U.S. patent application Ser. No. 08/587,628, filed Jan. 17, 1996, abandoned, which in turn is a continuation application of U.S. patent application Ser. No. 08/489,238, filed Jun. 12, 1995, now U.S. Pat. No. 5,513,244, which in turn is a continuation application of U.S. patent application Ser. No. 08/073,755, filed Jun. 8, 1993, abandoned. This application is also a continuation-in-part application of U.S. patent application Ser. No. 08/622,749, filed Mar. 27, 1996, now pending.

FIELD OF THE INVENTION

The present invention pertains to a remote-controlled control, monitoring and/or security apparatus and method for vehicles, motor vehicles, marine vessels and vehicles, aircraft, recreational vehicles, residential premises and/or commercial premises and, in particular, to a remote-controlled control, monitoring and/or security apparatus and method for exercising and/or providing remote-controlled immediate, as well as deferred, control, monitoring, security, anti-theft and/or theft deterrent functions for vehicles, motor vehicles, marine vessels and vehicles, aircraft, recreational vehicles, residential premises and/or commercial premises.

BACKGROUND OF THE INVENTION

Anti-theft devices for vehicles and premises are known in the prior art for preventing and/or thwarting the theft of a vehicle and/or of a premises. Vehicle recovery devices or systems are also known for recovering a motor vehicle. These known anti-theft and/or vehicle recovery devices may be of the active or passive variety and are typically available in many forms (i.e. steering wheel locks, hood locks, ignition system cut-off devices, alarms, vehicle homing devices with associated receiving devices, etc.). In some cases, these devices may be of a very simple design, while in other cases, they may be of a more sophisticated design. However, as is well known, these known anti-theft and/or vehicle recovery devices or systems may be easily defeated by thieves, and especially, by professional thieves and/or have other disadvantages associated with their use. Experience has shown that even the most sophisticated of anti-theft devices may be defeated by an experienced, and determined, thief, and that vehicle recovery systems also have drawbacks associated with their use.

In the case of some vehicle recovery devices, their use may be limited by the availability, or lack thereof, of the corresponding tracker or receiver device(s) in the particular locality, or the lack of same by the law enforcement department in a particular area.

In recent times, an even more disturbing criminal practice, involving the theft of motor vehicles, has rendered most anti-theft devices virtually useless. This criminal practice, known as car-jacking, has gained widespread attention. Car-jacking usually occurs when a thief or thieves confront a motorist or motor vehicle operator, when the motor vehicle engine is running, or when the car thief obtains easy access to the motor vehicle ignition keys and to the motor vehicle, either by force or by the threat of force, thereby bypassing, and rendering useless, any of the widely known anti-theft and/or theft-deterrent devices, thereby gaining control and/or possession of the motor vehicle. In these instances, the

motorist or motor vehicle operator is well advised to surrender the motor vehicle. However, once surrendered, the motor vehicle is virtually lost to the car thief.

Anti-theft and/or theft-deterrent devices which attempt to defeat the ultimate vehicle theft, such as caused by car-jacking, by disabling the motor vehicle during the "getaway", such as by shutting off power to the motor vehicle engine, have major disadvantages and drawbacks in that they could shut-off the vehicle engine at an inopportune instant in time, thereby causing a dangerous condition to exist which could lead to an accident and resulting injuries to individuals as well as damage to property. These accidents may arise when the motor vehicle power is suddenly shut-off while the vehicle is in motion, which condition could cause the vehicle to suddenly, or even gradually, lose power on a roadway or highway, while traveling at a moderate or at a high rate of speed and/or when a power steering and/or a power braking system, which derives its power from the vehicle engine, suddenly loses power upon the loss of the engine power. As noted above, accidents such as these may result in injuries to people, both inside and outside the vehicle, as well as property damage caused by, and to, the vehicle.

The above described disadvantages and drawbacks of the prior art devices may also pose accident liability concerns to those manufacturers and/or sellers of these devices, as well as to the owner or operator of the motor vehicle, as these entities and/or individuals may be held liable for the injuries and/or the damages sustained as a result of the above described accidents.

Vehicle recovery systems are known which include a vehicle homing device, which is activated and which emits homing signals which are used to home in on, or to locate, the vehicle. These vehicle recovery systems usually require that the law enforcement agency have corresponding homing signal receivers and/or equipment and that they be kept in operating condition, in order to effectively home in on, or locate, the vehicle. Unless the local police or law enforcement authorities have such equipment, the homing signal recovery device serves little purpose in recovering the vehicle in that locale. Other vehicle recovery systems require that a police report be made prior to an activation of the homing and/or recovery equipment, which practice could result in the loss of valuable time in the vehicle recovery process. The above problems concerning vehicle security are equally applicable to and present an equal or even greater problem in providing security for marine vessels and vehicles, aircraft and/or recreational vehicles.

Providing security for residential premises and/or commercial premises is also of great concern, especially when such premises are left vacant for hours and/or days at a time. These concerns may arise while residential premises are left unoccupied during the working day, when second homes and/or vacation homes are left unoccupied for days, weeks and months at a time, and in commercial premises which may also be left unoccupied for long periods of time such as after working hours or during weekends or other prolonged periods of time when these premises may be closed and/or unoccupied. While anti-theft and/or security systems exist for residential and/or commercial premises, such systems fail to enable the owner or occupant and/or other authorized individual to conveniently and effectively exercise and/or perform control, monitoring and/or security functions with regards to these premises. The ability to conveniently and effectively enable one to exercise and/or to perform control, monitoring and/or security functions would prove to be invaluable in allowing owners, occupants and/or other

authorized individuals to exercise and/or to provide control, monitoring and/or security functions over these premises, from a remote location and at any time.

SUMMARY OF THE INVENTION

The present invention provides an apparatus and a method for overcoming the disadvantages and drawbacks which are associated with the known prior art anti-theft and/or theft deterrent systems and, in particular, anti-theft and/or theft-deterrent systems for vehicles, marine vessels and vehicles, aircraft and recreational vehicles as well as for residential premises and/or for commercial premises.

The apparatus of the present invention comprises a transmitter system for transmitting an electrical, an electronic, an electromagnetic or other suitable signal, transmittable over a communication system and/or medium, upon an activation by the owner or authorized user or operator of the vehicle, motor vehicle, marine vessel, aircraft, recreational vehicle, and/or the owner, occupant and/or authorized individual of and for the residential premises and/or the commercial premises. The transmitter should also consist of a user interface device and a transmitting device. The transmitter should also have a receiver associated therewith for receiving signals. In this regard, the transmitter/receiver combination may be replaced and/or implemented with and/or by a transceiver. The transmitter transmits a signal, in response to an authorized user or operator accessing and/or activating the apparatus.

The transmitter system is a remote system, which may or may not be physically connected to the remainder of the apparatus. Further, the transmitter system is not located in the vehicle, motor vehicle, marine vessel or vehicle, aircraft, recreational vehicle, residential premises and/or commercial premises, but rather, is located external from, and/or separate and apart from, the vehicle.

The apparatus also comprises a receiver for receiving the signals which are transmitted by the transmitter or transceiver system. The receiver receives the signal(s) which is transmitted by the transmitter or transceiver and provides an indication, in the form of a signal transmission, back to the transmitter or transceiver and, in particular, the transmitter receiver, which signifies that a signal has been received by the apparatus. The receiver also generates data which is indicative of the signal, or a portion thereof, which has been received. The receiver should also be provided with its own transmitter. In this regard, this receiver/transmitter combination may also be replaced and/or implemented with and/or by a transceiver.

The transmitter/receiver combination should provide for the transmission and for the reception of a multitude of remote electrical, electronic, electromagnetic, and/or other suitable signals, over long distances and/or in a mobile and/or a wireless communications environment. Telephone signals and telephone communication devices can be utilized in the present invention as well as personal computers which can be utilized with telecommunications and/or other suitable communication systems and/or mediums.

Upon receiving the signal, the receiver generates a distinct signal which is indicative of the signal transmitted from the transmitter. At least a portion of the transmitted signal may include a valid access code, which accesses the receiver and the apparatus. The access code serves to provide for security measures which may be taken in conjunction with the use of the apparatus.

The apparatus also comprises a controller or a central processing unit (CPU), which is electrically connected with

the receiver and which receives, or reads, whichever the case may be, the signal or signals, or portions thereof, which are generated by the receiver. The CPU also has associated therewith a read only memory device(s) and random access memory device(s). The data which is received by the receiver is processed by the apparatus.

The CPU may also have a transmitter associated therewith for transmitting signals to the transmitter receiver or transceiver. In this manner, the CPU of the apparatus may respond to a user data transmission, command, or inquiry with a transmitted signal.

In the case of vehicles, motor vehicles, marine vessels and vehicles, aircraft and recreational vehicles (hereinafter referred to collectively as "vehicles"), the CPU is electrically connected and/or linked to the vehicle ignition system, which is located externally from the apparatus. The CPU may or may not be connected with and/or linked to the vehicle ignition system through an ignition system interface. The CPU may transmit signals to, as well as receive signals from, the vehicle ignition system. In this manner, the CPU and the vehicle ignition system may exchange information between each other.

The CPU, upon receiving an appropriate signal from the receiver, and upon the completion of a data processing routine, may issue a suitable signal, to the vehicle ignition system. This signal may be one which will disable, re-enable and/or reset the vehicle ignition system. The CPU may also interrogate the ignition system and/or receive data from the ignition system which is indicative of ignition system status.

The CPU may also be electrically connected and/or linked to the vehicle fuel system which is also located externally from the apparatus. The CPU may or may not be connected with and/or linked to the vehicle fuel system through a fuel system interface. The CPU is capable of issuing a signal, to disable, re-enable and/or reset the vehicle fuel system. The CPU may also interrogate and/or receive data from the fuel system which is indicative of fuel system status. The CPU may also provide control over the vehicle exhaust system in a similar fashion or in an analogous manner.

The CPU may also be electrically connected and/or linked to at least one or more of a variety of vehicle equipment systems. The vehicle equipment system or systems are located externally from the apparatus and may or may not be connected and/or linked to the CPU via a respective and/or associated vehicle equipment system or systems interface. The vehicle equipment system or systems, which varies for each type of vehicle (i.e., vehicle, motor vehicle, marine vessel or vehicle, aircraft and/or recreation vehicle) may include, but is not limited to, an exterior and/or an interior siren or alarm, a horn, a vehicle exterior light system(s), a power door lock or other locking system or device, a hood locking system, a video recording device and/or a camera, and/or an audio recording device, for providing surveillance of the vehicle interior and/or exterior, an intercom system, for providing communications between vehicle users and/or occupants and the owner, operator and/or authorized individual, cellular or mobile phones and/or any one or more of the widely known vehicle anti-theft systems, alarm systems and/or stolen vehicle and/or other type of vehicle recovery systems and/or devices.

Each of the vehicle equipment systems, if utilized in conjunction with the apparatus, may be activated, de-activated, reset or in some other way controlled and/or monitored by the apparatus of the present invention. The use of any one or more of the vehicle equipment system or systems is optional.

The vehicle equipment system or systems receives signals from the CPU, which signals serve to activate, de-activate, or vice versa, whichever the case may be, the respective vehicle equipment system(s).

The apparatus may also comprise a vehicle position and locating device which can be utilized in order to determine the position and/or the location of the vehicle. The vehicle position and locating device can be utilized so as to determine the position of the vehicle anywhere in the world and provide for the transmission of vehicle position and/or location data, via an associated transmitter, to an appropriate system receiver so that vehicle position would be available to the owner, user and/or authorized individual and/or so that the vehicle may be located and/or tracked and recovered.

The apparatus may also comprise a vehicle position and locating system receiver, which is employed for receiving and/or processing the data which is transmitted from the vehicle position and locating device.

The vehicle position and locating device may comprise a positioning system computer and a global positioning device with associated global positioning system receiver. The vehicle position and locating device may also comprise a position data transmitter for transmitting the vehicle position and/or location data to the vehicle position system receiver. The vehicle position and locating device may also comprise a data base which contains digital and/or digitized map data, which can be utilized in order to determine the geographical position of the vehicle from the calculated "raw" position data obtained from the global positioning device. In this manner, vehicle position and/or location on a map may be obtained.

Vehicle position and/or location data can be transmitted to the vehicle position system receiver which may be located at, or accessible to, the authorized user or operator and/or authorized individual at any location and/or at the location of an authorized office or agency, such as at a central security office or agency or local or regional law enforcement office or agency, which is duly authorized to receive the vehicle position and/or location data for the vehicle.

The vehicle position and locating device may also perform updated global positioning calculations so as to provide for a tracking of a vehicle movement. The apparatus may also ascertain vehicle movement by monitoring and/or tracking vehicle position data as it is updated.

The vehicle position system receiver may be equipped with an appropriate computer system and a receiver for receiving the data transmitted by the transmitter of the vehicle position and locating device.

The vehicle position system receiver may comprise a CPU for controlling the operation of the system receiver which CPU is connected and/or linked to the receiver for receiving and/or for reading the vehicle position and/or location data. The system receiver may also comprise a user interface device, a display device, an output device and a database containing digital map data for use in determining geographical position of a vehicle. The system receiver may also comprise a transmitter for sending data and/or signals to the vehicle position and locating device and/or for transmitting signals to the CPU and/or to the transmitter receiver.

The system receiver may also be utilized in conjunction with a home and/or a personal computer and/or other personal communications device and/or apparatus which may be utilized with an associated receiver or equivalent peripheral device(s).

A home and/or personal computer, and/or other personal communications device and/or apparatus may also be uti-

lized for performing the functions of the transmitter and the vehicle position and locating system receiver. The apparatus may also be utilized in conjunction with a computer network such as an on-line service and/or on, or over, the Internet and/or the World Wide Web, by employing an appropriate server computer and/or an associated Web Site and/or Web Site technology in conjunction with an appropriate communication medium.

Upon the occurrence, or the discovery thereof, of the theft of a vehicle, or simply in order to monitor vehicle status or location, the authorized user or operator may activate the apparatus by entering an access code into the transmitter or transceiver interface. Entry of a valid access code will activate a signal transmission from the transmitter or transceiver to access the apparatus.

The authorized user or operator can then transmit a command code from the transmitter or transceiver to the receiver of the apparatus. In a case when the vehicle has been stolen, the command code may be a vehicle disable command code. It should also be noted that a vehicle re-enable or reset command code, or any other suitable command code, monitoring code, etc., which would represent a function or operation to be performed by the apparatus, may also be entered. The command code is then transmitted to, and received by, the receiver.

The command code data is then transmitted to, or read by, the CPU for command code identification and for further processing, if necessary. In this manner, an authorized user or operator, upon learning of the theft of the vehicle, or simply attempting to ascertain the status and/or location of the vehicle, may easily access and/or activate the apparatus by simply "calling up" or transmitting a signal to the apparatus.

In the case where the motor vehicle has been stolen, and the authorized user or operator wants to prevent and/or thwart the theft of the vehicle and recover the vehicle, the command code which may be entered may be a vehicle disable command code (disable code) which will disable the vehicle and activate the vehicle position and/or locating device. If the authorized user or operator desires to re-enable the vehicle, such as when the motor vehicle has been found or recovered, so as to render the vehicle re-enabled or operational, the command code to be entered may be a vehicle re-enable or reset command code.

If a valid disable code is transmitted to the apparatus, the vehicle position and locating device is activated and various vehicle systems, including the vehicle ignition system, fuel or fuel pump system and/or exhaust system, and/or at least one or more of a variety of utilized vehicle equipment system(s), may either be activated, de-activated, or reset depending upon the circumstances.

The operation of the vehicle position and locating device may proceed and continue simultaneously and/or concurrently with the operation of the apparatus and the CPU. Any one or more of a vehicle equipment systems, including a vehicle alarm and/or homing device may also be activated.

Upon the vehicle being found or recovered, such as in a manner resulting from utilizing the vehicle position and locating device, the authorized user or operator may once again access the apparatus by entering a valid access code and by then entering a valid re-enable or reset command code.

The CPU may then issue a control signal to re-enable or reset the vehicle ignition system, vehicle fuel or fuel pump system and/or exhaust system and/or de-activate or re-activate, any one or more of the various vehicle equip-

ment systems which are utilized. The vehicle position and/or locating device may also be de-activated.

Safeguards may be employed in order to prevent a wrong or a mis-dialed number or unauthorized transmission(s) from accidentally accessing and activating the apparatus, and further, may serve to prevent an unauthorized or an unwanted disabling or re-enabling or setting or resetting of the vehicle ignition system, the vehicle fuel or fuel pump system and/or the vehicle exhaust system and/or the activation, de-activation, or resetting of any one or more of the various vehicle equipment systems which may be utilized.

As noted above, a disable command code may cause the apparatus to activate a vehicle position and locating device which may operate simultaneously and/or concurrently with, and independently of, the operation of the apparatus and the CPU. Once activated, the vehicle position and locating device may activate the global positioning device which calculates vehicle position data by using well known global positioning calculation methods and/or techniques.

Once the vehicle position data has been calculated, the position data can then be transmitted to the vehicle position system receiver which is located at the location of the authorized user or operator, or at the authorized office, agency or other entity. Geographic position and/or location data (i.e. street location, location on a map, etc.) for the vehicle may also be obtained by processing the position and/or location data in conjunction with digital map and/or other suitable data. The transmission of position data may be repeated for a predetermined time interval, after which the global positioning device may calculate updated position data. The vehicle position data which is received by the vehicle position system receiver may then be employed to find and/or to recover the vehicle. Vehicle position data may be updated, continuously and/or in some other suitable manner, by repeating the global positioning calculations.

Vehicle position data, along with updated vehicle position data, may also be utilized in order to track and/or to monitor vehicle movement. Vehicle position data may also be displayed and/or output for use in finding and/or recovering the vehicle.

The authorized user or operator may discontinue operation of and/or de-activate the global positioning device and/or the vehicle position system receiver, such as when the vehicle has been found or recovered and/or at any other time.

The global positioning device may be utilized to locate and/or to track vehicle movement anywhere in the world. In this manner, the apparatus of the present invention may be utilized to disable or de-activate vital vehicle systems and/or to find and/or recover a stolen vehicle and/or to monitor vehicle operation and/or vehicle location and/or movement.

Further, the present invention provides for an apparatus and a method for disabling and/or re-enabling various systems of the vehicle, when the vehicle is not in use, simply by "calling up" the apparatus so as to disable the vehicle and, thereby, provide added security against vehicle theft and/or to prevent damage to the vehicle and/or to any components thereof. In this manner, an authorized user or operator may disable the vehicle ignition system, fuel or fuel pump system, exhaust system and/or any one or more of a variety of the vehicle equipment systems, of a vehicle which may be parked and/or in use, from any location and/or at any time.

An authorized user or operator may also access the apparatus at any time and, with the use of an appropriate command code, may determine the operating status of the

vehicle, the apparatus, and/or any one or more of the various vehicle systems so as to determine if, for example, the ignition system or fuel or fuel pump system is activated or on, thereby alerting the authorized user or operator that someone is operating the vehicle. An authorized user or operator may also access the apparatus so as to determine vehicle position and/or location data or information and/or the geographic location of the vehicle. In this manner, the authorized user or operator can determine the status and/or the location of his or her vehicle at any time and for any reason. In this regard, a safe and an effective anti-theft and/or vehicle recovery apparatus and method is provided by the present invention.

The apparatus of the present invention may be utilized in conjunction with a multitude and/or a variety of valid command codes, wherein each different command code may selectively disable or re-enable or reset any one or any combination of the vehicle systems, such as the vehicle ignition system, the vehicle fuel or fuel pump system, the vehicle exhaust system and/or any one or more of the various vehicle equipment systems which may be utilized. In this manner, the authorized user or operator may utilize the present invention to selectively disable, re-enable, de-activate or re-activate any one or more of the vehicle systems, or a combination thereof, at his or her discretion, at any time, and from any location.

As noted above, an authorized user or operator may also utilize command codes for determining status of the apparatus or of the vehicle, or of any one or more of the vehicle systems. A command code may also be employed to simply determine vehicle position.

The apparatus may also be programmable by the user or operator via the transmitter or transceiver, or at the vehicle, so that certain parameters, such as the timing, and/or the degree of disabling or re-enabling, of the various vehicle systems may be programmed.

By utilizing a multitude of command codes, including disable codes and/or re-enable or reset codes, which codes affect different vehicle systems, or combinations thereof, it is also possible to selectively control the vehicle systems from a remote location. The apparatus may also be programmed for automatic activation and/or self-activation and/or automatic and/or programmed operation via a command code(s), so that the apparatus may become activated upon a certain occurrence, or lack thereof, and thereafter, provide for the disabling and/or the re-enabling of any one or more of the vehicle systems along with activating the vehicle position and/or locating device. The apparatus may also provide information pertaining to vehicle theft, status and/or position. The apparatus may also be designed and/or programmed to detect its unauthorized use and/or its use by an unauthorized individual. In this regard, the vehicle is capable of reporting itself as being stolen.

In an alternate embodiment of the present invention, an arming device and an activation device may be utilized in conjunction with the apparatus in place of the transmitter/receiver combination so as to provide for an automatic monitoring and/or activation of the apparatus. In such an embodiment, the command code(s) may be a default code and/or be user selected and/or programmable. Automatic activation may also be programmed by the user or operator via a command code(s) with apparatus operation activated upon the occurrence, or lack thereof, of a specified event.

In this manner, the arming device/activation device combination may be utilized so as to activate the apparatus and/or any one or more of the vehicle systems, including the

ignition system, the fuel or fuel pump system, the exhaust system and/or any one or more of the various vehicle equipment systems which are utilized in conjunction with the apparatus. The vehicle position and locating device may also be activated via the automatic activation of the apparatus.

In yet another alternate embodiment of the present invention, the vehicle position and locating device may comprise a plurality of global positioning devices which may be strategically located at various points and/or locations in or on the vehicle. Each of the global positioning devices may be placed at different points and/or locations in, or on, the vehicle, with the distances between each of the respective devices being recorded and stored. Upon the activation of the global positioning devices and the calculation of each position or location of each device, any change in distance between any two or more of the respective devices could be utilized in order to determine if the vehicle, or any portion thereof, has been dismantled or structurally altered, at least in part, or possibly to a greater extent.

The apparatus and the method of the present invention may also be utilized in conjunction with a central security office or agency, such as a private security service and/or by a local or regional law enforcement office or agency, in order to provide a prompt means by which to report a vehicle theft, provide for a manner in which to disable and/or re-enable a vehicle or vehicle system, and to determine vehicle position and/or location so as to facilitate the locating and the recovery of the vehicle. In this regard, the present invention may be utilized so as to allow control, monitoring and/or security functions to be exercised and/or performed by an authorized third party. The present invention may also be utilized so as to provide for a prompt law enforcement theft reporting, law enforcement response to the theft report and recovery of the vehicle.

An authorized user or operator may register their vehicle and apparatus with a central security office or agency such as by registering vehicle identification information along with vehicle access and command code data and any other pertinent information. Upon the occurrence of a vehicle theft, or the discovery thereof, the authorized user or operator can access the apparatus so as to exercise and/or to perform control, monitoring and/or security functions over same while, at the same time, allowing for a control, monitoring and/or a security function to be exercised and/or performed by the central security office or other entity. The apparatus, which is utilized at the central security office and/or other entity, may have the same control capabilities over the vehicle as that of the apparatus utilized in the vehicle. In this regard, status of the apparatus, the vehicle, any one or more of the various vehicle systems, and/or the vehicle position and/or location data may be obtained by the apparatus located at the central security office and/or other entity.

The apparatus which is utilized at the central security office may also be utilized in connection with an on-line service and/or on, or over, the Internet and/or the World Wide Web so as to provide for a means by which the authorized user or operator may utilize the apparatus in conjunction with a home and/or a personal computer and/or a commercial or industrial computer system (i.e., an internet server computer) and/or any other appropriate device.

In another embodiment, an access code may be only transmitted to, and received by, the central security office apparatus and the vehicle may be accessed and controlled

via an access and command code(s) which are transmitted by and from the central security office apparatus. Transmitter devices may also be located in the vehicle so as or to allow a vehicle occupant(s) to transmit signals directly to the central security office and/or agency and/or central equipment, (i.e., satellite, cellular communications site etc.) such as in instances where help may be required and/or in emergency situations.

In yet another embodiment, the access code may only be transmitted to, and received at, the vehicle. In this embodiment, the apparatus which is located in the vehicle may then transmit data to the apparatus located at the central security office thereby alerting the central security office or agency of the vehicle theft or status inquiry. The apparatus at the central security office may thereafter exercise and/or provide control over and/or monitor the functions of, the vehicle apparatus for a plurality of vehicles. Further, the central security office apparatus may also provide the means by which to allow a central security office or local or regional law enforcement office or agency to provide security monitoring over the vehicle(s) which are registered therewith.

In the case where the apparatus may be automatically activated, the vehicle apparatus may transmit a signal, indicative of vehicle theft and/or an unauthorized use or operation of the vehicle, to the central security office apparatus thereby reporting the unauthorized use or operation, or theft, of the vehicle before the authorized user or operator is able to discover same.

The central security office apparatus may also be utilized so as to verify and/or monitor apparatus accessing and/or activation by the authorized user or operator. The authorized user or operator may also "call" the central security office from any location, via any communication means and/or device in order to determine the status and/or the whereabouts or location of his or her vehicle. Both the vehicle apparatus and the central security office apparatus can exercise and/or perform the same control, monitoring and/or security functions over the vehicle.

In still another embodiment, the present invention may be utilized in conjunction with a residential premises, residential building and/or a home and/or a household control, monitoring and/or security system.

In the case where the present invention is utilized in conjunction with a residential premises, residential building and/or a home and/or a household control, monitoring and security system, the CPU may be electrically connected and/or linked to the home and/or household electrical system, which is located externally from the apparatus. The CPU may or may not be connected with and/or linked to the home electrical system through an electrical system interface. The CPU may transmit signals to, as well as receive signals from, the home electrical system. In this manner, the CPU and the home electrical system, may exchange information between each other.

The CPU, upon receiving an appropriate signal from the receiver, and upon the completion of the requisite data processing routine may issue an electrical, an electronic, and/or any other suitable signal, including a digital command signal, to the home electrical system. This electrical, electronic and/or other suitable signal or digital command signal may be one which will disable, re-enable or reset the home electrical system. The CPU may also interrogate the electrical system and/or receive data from the electrical system which is indicative of electrical system status (i.e., whether the electrical system is on or off and/or to what extent certain portions thereof may be on or off).

The CPU may also be electrically connected and/or linked to the home heating system which is also located externally from the apparatus. The CPU may or may not be connected with and/or linked to the home heating system through a heating system interface. The CPU is capable of issuing an electrical, electronic and/or other suitable signal, including a digital signal, to disable or to re-enable the home heating system. The CPU may also interrogate and/or receive data from the home heating system which is indicative of home heating system status (i.e., whether the heating system is on or off and/or to what extent certain portions thereof may be on or off).

The CPU may also be electrically connected and/or linked to the home air conditioning system which is also located externally from the apparatus. The CPU may or may not be connected with and/or linked to the home air conditioning system through an air conditioning system interface. The CPU is capable of issuing an electrical, electronic and/or other suitable signal, including a digital signal, to disable or to re-enable the home air conditioning system. The CPU may also interrogate and/or receive data from the home air conditioning system which is indicative of home air conditioning system status (i.e., whether the air conditioning system is on or off and/or to what extent certain portions thereof may be on or off).

The CPU may also be electrically connected and/or linked to the home water system which is also located externally from the apparatus. The CPU may or may not be connected and/or linked to the home water system through a home water system interface (i.e., electrical shut-off valve). The CPU is capable of issuing an electrical, electronic and/or other suitable signal, including a digital signal, to disable or to re-enable the home water system. The CPU may also interrogate and/or receive data from the home water system which is indicative of the water system status (i.e., whether the home water system or any portion thereof is on or off).

The CPU may also be electrically connected and/or linked to the home thermostat or environmental control system so as to control and monitor interior temperature. In this manner, the home thermostat system may then be adjusted and/or controlled by the user or operator via the apparatus. The home thermostat system may be connected to the home heating system and/or to the home air conditioning system so as to activate, set and/or control the operation of these systems so as to achieve the desired temperature and/or environmental conditions in the home.

The CPU may also be electrically connected and/or linked, via interfaces if needed, to any one or more of a variety of home equipment systems which may include a home anti-theft and/or burglary alarm system, an interior and/or exterior siren or alarm, interior and/or exterior lighting systems, electrical and/or electronically controlled locking devices for doors and/or windows, including electrical and/or electronic dead bolt locks and/or other types of locking devices, electrical systems and devices for controlling electrical circuits or systems room-by-room, device-by-device, and/or appliance-by-appliance.

The home equipment system may also include devices for controlling any one or more of the electrical circuitry, such as circuits controlled by fuses, circuit breakers or equivalent devices, devices for controlling and/or monitoring hot water heater(s), garage door opener(s), lawn sprinkler system(s), electric fences and/or fencing, in-ground or above-ground pool equipment, filters and/or heaters, home water valves, individual room water valves, home fire detector equipment and home fire extinguishment equipment, jacuzzis, hot tubs,

pet feeders and/or any other electrical and/or electronic devices and/or appliances and/or those devices and/or appliances which may be electrically and/or electronically controllable. Home equipment systems may door and window closing, opening and locking devices.

The home equipment systems may also include any and all home appliances such as televisions, telephones, telephone answering machines, VCRs, stoves, ovens, microwave ovens, door bells, individual lights or lamps, blenders, toasters, irons, computers, word processors, stereos, radios, and any other home appliance and/or devices which may be electrically and/or electronically activated and/or controllable.

The home equipment systems may also include video recording equipment, which may include video recording device(s) and/or a camera(s), such as those utilized in conjunction with personal computers, televisions, digital televisions, interactive televisions, surveillance systems, display telephones and/or other communication devices, including personal communication devices.

The video recording device(s) and/or camera(s) may be digital recording devices or cameras or other suitable video recording and/or photography equipment. The video recording device(s) and/or camera(s) may be located at any location on and in the interior and/or at the exterior of the home or premises and may have associated therewith transmitting devices for transmitting the recorded video or photograph(s) to the owner or occupant and/or other authorized individual so as to provide surveillance and/or monitoring capabilities for the home and/or premises.

The home equipment system may also include audio recording equipment, which may include microphones and/or tape recorders, such as those utilized in conjunction with personal computers, televisions, digital televisions, interactive televisions, display telephones and/or other communication devices, including personal communication devices.

The audio recording device(s) may have a transceiver or transmitter/receiver system associated therewith for transmitting audio information to the owner or occupant and/or authorized individual so as to provide for the monitoring and/or the surveillance of the interior and/or the exterior of the home.

The home equipment systems may also include an intercom system or device or telephone, cellular, digital or otherwise, for providing a means by which to allow the user or operator, or other authorized individual, to communicate with the persons present in, or occupants of, the home or the premises. The home equipment systems may also include monitoring device(s) for reading and/or monitoring the home fuel supply, gas meter and/or gas usage, water supply, water meter and/or water usage, electrical generator and/or alternator operation, electricity meter and/or electricity usage, heat and/or air conditioning usage, gas and/or oil or other fuel supply and/or usage, telephone usage, appliance usage, etc., a home control system and/or any other home operation and/or system function. The monitoring device(s) may have associated therewith a transceiver or transmitter/receiver system for transmitting data and/or information recorded and/or read by the monitoring device(s) to the user or operator and for receiving signals such as, for example, control signals, by which the user or operator may exercise control over the monitoring device(s). The monitoring devices and the corresponding devices which they monitor may be linked via wireless devices and/or over a wireless medium.

When used in conjunction with a residential premises, residential building and/or home or household system, the

apparatus and method of the present invention may be utilized and/or operates in the same or in a similar and/or analogous manner as it is utilized and/or operates in conjunction with vehicles so as to provide control, monitoring and/or security functions for and over a home and/or residential premises. In this manner, a homeowner or occupant may access a home system at any time, and from any location, and thereby exercise and/or provide control, monitoring and/or security functions over any home system, equipment, device and/or appliance. The owner or occupant may also monitor the status, state, or operation of any home system, equipment, device and/or appliance. Lastly, the owner or occupant may exercise and/or perform security related functions or operations on, and over, the home system, equipment, device and/or appliance.

In still another embodiment, the apparatus and method of the present invention may be utilized in conjunction with a commercial building, commercial office and/or commercial premises control, monitoring and/or security system. In the case where the present invention is utilized in conjunction with a commercial building, commercial office and/or commercial premises control, monitoring and/or security system, the CPU may be electrically connected and/or linked to the commercial office and/or premises electrical system, heating system, air-conditioning system, water system, thermostat system, and/or to at least any one or more of a variety of commercial office and/or premises equipment systems, which may include an anti-theft and/or burglary alarm system, an interior and/or exterior siren or alarm, interior and/or exterior lighting and/or lighting system(s), electrical and/or electronically controlled locking devices for doors and/or windows, including electrical and/or electronic dead-bolt locks and/or locking devices.

The CPU may also be connected and/or linked to commercial office and/or premises equipment systems which include electrical systems for controlling electrical circuits or systems room-by-room, device-by-device, and/or appliance-by-appliance, devices for controlling any one or more of the electrical circuitry, such as circuits controlled by fuses, circuit breakers or equivalent devices, devices for controlling and/or monitoring hot water heaters, garage door openers, lawn sprinkler systems, electric fences and/or fencing, in-ground or above-ground pool and/or fountain equipment, filters and/or heaters, fire detector equipment, fire extinguishment equipment, and office equipment, power door and/or window closing, opening and locking equipment and any other electrical and/or electronic device or item or any device and/or item which is electrically or electronically controllable.

The commercial office and/or premises equipment systems may also include any and all commercial office and/or premises appliances such as televisions, telephones, telephone answering machines, alarm systems, VCRs, stoves, ovens, microwave ovens, door bells, individual lights or lamps, office equipment and appliances, computer and associated peripherals, word processors, stereos, radios, manufacturing equipment and any other commercial office and/or premises equipment.

The commercial office and/or premises equipment system may also include a video recording equipment, which may include video recording device(s) and/or a camera(s), such as those utilized in conjunction with personal computers, televisions, digital televisions, interactive televisions, display telephones and/or other communication devices, including personal communication devices, and/or a still picture camera(s). The video recording device(s) or camera(s) may be digital recording devices or cameras or other

suitable devices or cameras, including typical video recording devices or cameras for providing video recording and/or surveillance.

The video recording device(s) or camera(s) may have a transceiver or transmitter/receiver system associated therewith for transmitting video images and/or photographs, recorded by the video recording device(s) or camera(s), to the owner or occupant and/or authorized individual so as to provide for the monitoring and/or the surveillance of the interior and/or the exterior of the commercial office and/or premises.

The commercial office and/or premises equipment system may also include audio recording equipment, which may include microphones and/or tape recorders, such as those utilized in conjunction with personal computers, televisions, digital televisions, interactive televisions, display telephones and/or other communication devices, including personal communication devices.

The audio recording device(s) may have a transceiver or transmitter/receiver system associated therewith for transmitting audio information to the owner or occupant and/or authorized individual so as to provide for the monitoring and/or the surveillance of the interior and/or the exterior of the commercial office and/or premises.

The commercial office and/or premises equipment system may also include an intercom system or device or telephone, cellular, digital or otherwise, for providing a means by which to allow the owner or occupant, or other authorized individual, to communicate with the persons present in, or occupants of, the commercial office and/or premises. The commercial office and/or premises equipment system may also include monitoring device(s) for reading and/or monitoring the commercial office and/or premises fuel supply, fuel usage, water supply, water usage, electricity meter, electricity usage, electrical generator and/or alternator operation, heat and/or air conditioning usage, gas and/or oil or other fuel usage, telephone usage, commercial office and/or premises equipment and/or appliance usage, etc., and/or commercial office and/or premises control system and/or any other commercial office and/or premises operation and/or system function.

The monitoring device(s) may have associated therewith a transceiver or transmitter/receiver system for transmitting data and/or information recorded and/or read by the monitoring device(s) to the user or operator and for receiving signals such as, for example, control signals, by which the user or operator may exercise control over the monitoring device(s). The monitoring devices and the corresponding equipment and/or devices to be monitored may be linked via wireless devices and/or over wireless communication systems.

The commercial office and/or premises equipment system or systems receives signals from the CPU, which signals serve to activate or de-activate, or vice versa, whichever the case may be, the respective commercial office and/or premises equipment system(s) which are utilized in conjunction with the apparatus.

When utilized in conjunction with a commercial office and/or premises, the apparatus and method of the present invention is utilized and/or operates in the same, or in a similar and/or analogous, manner as it is utilized and/or operates in conjunction with vehicles and/or with residential premises, etc., so as to allow control, monitoring and/or security functions to be exercised and/or performed on, and over, a commercial office and/or premises.

In this manner, an owner, occupant and/or authorized individual may access a commercial office and/or premises

system at any time and from any location and thereby exercise and/or perform control, monitoring and/or security functions over any commercial office and/or premises system, equipment, device and/or appliance. The owner, occupant or authorized individual may also monitor the status, state or operation of any commercial office and/or premises system, equipment, device and/or appliance.

In any of the above described embodiments, the present invention may be utilized in conjunction with any suitable communication device(s) and/or communication system(s). In this manner, the present invention may be utilized in conjunction with a telephone, a touch tone telephone, a cordless telephone and/or a cellular or mobile telephone, a home and/or a personal computer having associated telecommunication devices or other suitable peripheral device(s) such as a modem and/or a fax/modem, personal communication devices which can operate over an appropriate telecommunications system, and/or other suitable communications systems and/or mediums, including radio signal, optical, satellite and/or other communications systems and/or mediums. Any suitable communication system and/or medium may be utilized.

Personal communication service (PCS) systems and devices, including stationary, portable and/or hand-held devices, may also be utilized. Digital signal communications devices and systems may also be utilized. Interactive and/or digital televisions, personal communication devices, personal communication services (PCS) devices, personal digital assistants, cellular telephones, display telephones, display cellular telephones and electronically equipped watches and/or other devices and/or effects may also be utilized for performing user interactive control, monitoring and/or security functions in conjunction with the present invention.

The interface devices utilized in any of the various embodiment of the present invention may be wireless devices or modules which need not be directly connected to the CPU or to its respective equipment system in a hard-wired manner. In this regard, hard-wired electrical connections may be unnecessary. In the case of wireless interface devices or modules, corresponding wireless technology and/or systems should be utilized in order to provide for the wireless control and/or operation of the respective equipment(s).

Accordingly, it is an object of the present invention to provide a remote-controlled control, monitoring and/or security apparatus and method for exercising and/or for performing remote controlled control, monitoring and/or security functions for vehicles, motor vehicles, marine vessels and vehicles, aircraft, recreational vehicles, residential premises and/or commercial premises.

It is another object of the present invention to provide a remote-controlled control, monitoring and/or security apparatus and method which provides for the selective control, activation and/or de-activation and/or for the programmed control of any one or more of an ignition system, a fuel system, an exhaust system and/or any one or more of various equipment systems of, and for, vehicles, motor vehicles, marine vessels and vehicles, aircraft and/or recreational vehicles.

It is another object of the present invention to provide a remote-controlled control, monitoring and/or security apparatus and method which provides for the selective control, activation and/or deactivation and/or for the programmed control of any one or more of an electrical system, heating system, water system, air conditioning system, thermostat system and/or any one or more of the various systems,

equipment systems, devices and/or appliances, etc., of, and for, residential premises and/or commercial premises.

It is another object of the present invention to provide a remote-controlled control, monitoring and/or security apparatus and method which is utilized in conjunction with a global positioning system or other positioning system and which provides for a determination of the position and/or location of, and for, vehicles, motor vehicles, marine vessels and vehicles, aircraft, recreational vehicles, residential premises and/or commercial premises.

It is another object of the present invention to provide a remote-controlled control, monitoring and/or security apparatus and method which provides programming, information gathering, and monitoring capabilities for, and regarding, the status of and/or the operating state(s) of various systems of, and for, vehicles, motor vehicles, marine vessels and vehicles, aircraft, recreational vehicles, residential premises and/or commercial premises.

It is still another object of the present invention to provide a remote-controlled control, monitoring and/or security apparatus and method for vehicles, motor vehicles, marine vessels and vehicles, aircraft, recreational vehicles, residential premises and/or commercial premises which is utilized in conjunction with a home and/or a personal computer, a telephone, a display telephone, a cellular telephone, a television, an interactive television, a digital television, a personal digital assistant and/or a personal communications services device and/or other personal communications devices.

It is yet another object of the present invention to provide a remote-controlled control, monitoring and/or security apparatus and method for vehicles, motor vehicles, marine vessels and vehicles, aircraft, recreational vehicles, residential premises and/or commercial premises which may be utilized, operated and/or controlled via, over, or with, an on-line service, and/or on, or over, the Internet and/or the World Wide Web.

It is still another object of the present invention to provide a remote-controlled control, monitoring and/or security apparatus and method for vehicles, motor vehicles, marine vessels and vehicles, aircraft, recreational vehicles, residential premises and/or commercial premises which provides for an automatic activation, self-activation and/or programmed activation of the apparatus.

It is yet another object of the present invention to provide a remote-controlled control, monitoring and/or security apparatus and method for vehicles, motor vehicles, marine vessels and vehicles, aircraft, recreational vehicles, residential premises and/or commercial premises which is utilized in conjunction with wireless devices and/or systems and/or with wireless communication technology.

It is still another object of the present invention to provide a remote-controlled control, monitoring and/or security apparatus and method for vehicles, motor vehicles, marine vessels and vehicles, aircraft, recreational vehicles, residential premises and/or commercial premises which is utilized in conjunction with a central security office and/or agency.

It is yet another object of the present invention to provide a remote-controlled control, monitoring and/or security apparatus and method for vehicles, motor vehicles, marine vessels and vehicles, aircraft, recreational vehicles, residential premises and/or commercial premises which is utilized in conjunction with a central security office and/or agency and/or with, or over, an on-line service and/or on, or over, the Internet and/or the World Wide Web and/or other information structure, infra-structure, system and/or communication system or medium.

It is yet another object of the present invention to provide a remote-controlled control, monitoring and/or security apparatus and method which is programmable and which may be programmed for self-activation and/or programmed operation.

Other objects and advantages of the present invention will be apparent to those individuals skilled in the art upon a review of the Description Of The Preferred Embodiment taken in conjunction with the Drawings which follow.

BRIEF DESCRIPTION OF THE DRAWINGS

In the Drawings:

FIG. 1 illustrates a block diagram of the apparatus which is the subject of the present invention;

FIG. 2 illustrates the vehicle position and locating device of FIG. 1 illustrating the main components thereof in block diagram form;

FIG. 3 illustrates the vehicle position and locating system receiver of FIG. 1 illustrating the components thereof in block diagram form;

FIG. 4 illustrates a block diagram of a computer system which is utilized in an alternate embodiment of FIG. 1 for performing the functions of, and for, the transmitter and the vehicle position and locating system receiver of the apparatus of the present invention;

FIG. 5A illustrates the apparatus of FIG. 1 wherein the computer of FIG. 4 is utilized in an alternate embodiment in order to replace and to perform the functions of the transmitter and the vehicle position and locating system receiver of the apparatus of the present invention.

FIG. 5B illustrates an alternate embodiment of the apparatus of the present invention wherein the apparatus is utilized in conjunction with an on-line service and/or on, or over, the Internet and/or the World Wide Web;

FIG. 6 illustrates a flow diagram illustrating the preferred embodiment operational steps and/or sequences of operation of the apparatus and the method of the present invention;

FIG. 7 illustrates the preferred embodiment operation, in flow diagram form, of the vehicle position and locating device which is utilized in the apparatus of the present invention;

FIG. 8 illustrates the preferred embodiment operation, in flow diagram form, of the vehicle position system receiver which is utilized in the apparatus of the present invention;

FIG. 9 illustrates an alternate embodiment of the present invention wherein an arming device and an activation device are utilized in conjunction with, and for, an automatic activation of the apparatus of the present invention;

FIG. 10 illustrates an alternate embodiment of the vehicle position and locating device which comprises a plurality of global positioning devices and corresponding global positioning receivers;

FIG. 11A illustrates another alternate embodiment of the present invention wherein the apparatus is utilized in conjunction with a central security office or agency;

FIG. 11B illustrates yet another alternate embodiment of the present invention wherein the apparatus of FIG. 11A is utilized in conjunction with an on-line service and/or on, or over, the Internet and/or the World Wide Web.

FIG. 12 illustrates an alternate embodiment of the present invention, wherein the apparatus and method is utilized in conjunction with a boat;

FIG. 13 illustrates an alternate embodiment of the present invention, wherein the apparatus and method is utilized in conjunction with an airplane.

FIG. 14 illustrates an alternate embodiment of the present invention wherein the apparatus is utilized in conjunction with a snowmobile;

FIG. 15 illustrates an alternate embodiment of the present invention wherein the apparatus and method is utilized in conjunction with a home or residential premises control system; and

FIG. 16 illustrates an alternate embodiment of the present invention wherein the apparatus and method is utilized in conjunction with a commercial office and/or premises control system.

DESCRIPTION OF THE PREFERRED EMBODIMENT

FIG. 1 illustrates a block diagram of the apparatus which is the subject of the present invention and which is denoted generally by the reference numeral 1. As illustrated in FIG. 1, the apparatus 1 comprises a transmitter system 2, for transmitting an electrical, an electronic, an electromagnetic or other suitable signal, upon an activation by a motor vehicle owner or authorized user or operator, hereinafter referred to collectively as the "authorized user or operator".

While the foregoing description of the preferred embodiment is directed to a motor vehicle and, in particular, to an automobile, the term "motor vehicle" includes, but is not limited to, automobiles, trucks, buses, tractor trailers, construction equipment, farm equipment, commercial vehicles, recreational vehicles, motorcycles, recreational vehicles, motor and/or mobile homes, etc. Any of the above noted vehicles may be manned and/or unmanned and may also include law enforcement and/or military vehicles and/or equipment. The present invention may also be utilized in marine vehicles and/or vessels, boats, ships, aircraft, airplanes, jets, submersible and/or underwater vehicles and/or vessels, space vehicles and/or vessels and satellites, all of which may be manned and/or unmanned. The present invention may also be employed in conjunction with gasoline, diesel, alternate fuel and/or electrically powered and/or propelled vehicles.

In the preferred embodiment, the transmitter system 2 consists of a user interface device 2A and a transmitting device or transmitter 2B. The transmitter 2 also has a receiver 2C for receiving signals as will be described below. In this regard, the transmitter/receiver combination may also be implemented by utilizing a transceiver. The user interface device 2A provides the means by which the authorized user or operator may access or activate the apparatus 1, as well as the means by which the authorized user or operator may enter access and/or command codes into the transmitter system 2. The transmitter 2B transmits a signal, in response to the authorized user or operator accessing or activating the apparatus 1. The user interface device 2A also comprises a device (not shown) for providing an audio and/or a video indication of system operation and/or status as well as providing information indicative of data received by the receiver 2C.

The transmitter system 2 is a remote system, which is not physically connected to the remainder of the apparatus 1. Further, the transmitter system 2, in the preferred embodiment, is not located in the motor vehicle, but rather, is located external from, and separate and apart from, the motor vehicle. In the preferred embodiment, the transmitter system 2 or transceiver, is designed to be capable of transmitting signals over long distances, i.e. tens, hundreds, and/or thousands of miles or farther. The transmitter system 2 or transceiver, in the preferred embodiment, is also capable

of transmitting a multitude of signals. As will be described below, this capability to transmit a multitude of signals allows for the transmission of a variety of command codes, and of multiple command codes, to the apparatus 1, which in turn, provides for an apparatus which may provide for a multitude of responses in the control and operation thereof.

In the preferred embodiment, the transmitter system 2 or transceiver is a touch tone telephone which may be a line-connected telephone, a cordless telephone and/or a cellular or mobile telephone. As described hereinafter, the transmitter system 2 may also be a home and/or a personal computer, having associated telecommunication devices or other suitable peripheral device(s) such as a modem and/or a fax/modem, or other personal communication device, which can operate over an appropriate telecommunications system, and/or other suitable communications systems, including radio signal, optical, satellite and/or other communications systems. The communications system utilized may operate anywhere in the electromagnetic and/or radio spectrum. In this regard, personal communication service (PCS) systems and devices, including stationary, portable and/or hand-held devices, may also be utilized. Digital signal communications devices and systems may also be utilized. Interactive and/or digital televisions, personal communication devices, personal communication services (PCS) devices, personal digital assistants, cellular telephones, display telephones, video telephones, display cellular telephones and electronically equipped watches and/or other devices and/or effects or accessories may also be utilized for user interactive and/or display or output applications and/or functions.

Applicant hereby incorporates by reference herein the subject matter of U.S. Pat. No. 5,081,667 which teaches a system for integrating a cellular telephone with a vehicle security system. Applicant also hereby incorporates by reference herein the subject matter of U.S. Pat. No. 5,276,728 which teaches a remotely activated automobile disabling system. Applicant further hereby incorporates by reference herein the subject matter of U.S. Pat. No. 5,113,427 which teaches a radio signal responsive vehicle device control system, and further, use of a personal paging unit in a paging system for receiving a radio signal. Applicant also hereby incorporates by reference herein the subject matter of U.S. Pat. No. 4,882,746, which teaches a cordless telephone system. Applicant further hereby incorporates by reference herein the subject matter of U.S. Pat. No. 5,138,649 which teaches a portable telephone handset with remote control. Applicant further hereby incorporates by reference herein the subject matter of U.S. Pat. No. 5,195,126 which teaches an emergency alert and security apparatus and method.

Referring once again to FIG. 1, the apparatus 1 also comprises a receiver 3, for receiving the signals which are transmitted by the transmitter system 2. The receiver 3 may be any receiver which is capable of receiving the remote electrical, electronic, electromagnetic, and/or other signals, which may be transmitted by the transmitter system 2. In the preferred embodiment, the receiver 3 is also capable of receiving any of a wide variety of signals, and/or multitude of signals, which may be transmitted by the transmitter system 2.

The transmitter system 2/receiver 3 combination, of the apparatus 1 is implemented, in the preferred embodiment, by a telephone/telephone beeper or pager system which systems and related techniques are well known in the telecommunications art. In such a telephone/telephone beeper or pager system, the transmitter 2 can be any touch-tone telephone which provides a user interface, in the form of the touch-

tone keypad or buttons, or the like, for entering a data code or sequence, and which may provide a means by which to transmit a signal, in response to the entered data, to an appropriate receiver device which is typically a telephone beeper or pager which may be serviced by an appropriate communications system or service.

The receiver 3 or beeper or pager, or the communication system which services same, in turn, provides an indication, in the form of a signal transmission, back to the transmitter 2 and, in particular, to the transmitter receiver 2C, which signifies that a signal has been received by the apparatus 1. The receiver 3 also generates data which is indicative of the signal, or a portion thereof, which has been received. In this regard, in the preferred embodiment, the receiver 3 is provided with its own transmitter 3A, or the communication system or service which services the receiver 3 may provide a transmitter (not shown) as may be the case with certain pager systems, such as and including two-way pager systems, for transmitting signals back to the transmitter system 2. It is important to note that the receiver 3/transmitter 3A combination, in appropriate cases, may be replaced with and/or implemented by a transceiver. The receiver 3 and/or receiver 3/transmitter 3A combination or transceiver may also be a cellular and/or mobile telephone which can receive and transmit signals at and from a mobile location.

It should be noted that the telephone/telephone beeper or pager system, including two-way pager systems, may be replaced with any other type of transmitter/receiver combination, electronic or otherwise, which provides for the transmission and reception of a multitude of remote electrical, electronic, electromagnetic, and/or other suitable signals, over long distances and/or in a mobile and/or a wireless communications environment. As noted above, a personal computer system which may be adapted to such operation, or a personal communication device(s) or personal communication services (PCS) device(s) may also be utilized for, or in, any of the transmitter/receiver system combinations described hereinabove and hereinbelow. Two way pagers may also be utilized for any, or in any, of the transmitter/receiver system combinations described hereinabove or hereinbelow.

In the preferred embodiment, upon receiving the signal, the receiver 3, generates a distinct signal which may be a digital, an electrical, an electronic and/or an electromagnetic or other suitable signal, which signal is indicative of the signal transmitted from the transmitter 2B of the transmitter system 2 and received by the receiver 3.

At least a portion of the signal transmitted from the transmitter system 2 to the receiver 3 may include a valid access code, which accesses the receiver 3, and the apparatus 1, which access code serves to provide for security measures which may be taken in conjunction with the use of the apparatus 1.

The apparatus 1 also comprises a controller or a central processing unit CPU 4, which is electrically connected with the receiver 3 and transmitter 3A and which receives, or reads, whichever the case may be, the digital signal or signals, or portions thereof, which are received by the receiver 3 and/or generated by the receiver 3 in response to the received signal. The CPU 4 may be any type of digital processing device. In the preferred embodiment, the CPU 4 is implemented by a microprocessor. The CPU 4 also has associated therewith a read only memory device (ROM) 5 and a random access memory device (RAM) 6 for storing data which is utilized by the apparatus 1. The data which is

received by the receiver 3 is processed by the apparatus 1 in the manner described below.

The use of a microprocessor as the CPU 4 provides for versatility in apparatus programmability, as well as facilitates an apparatus which can be made as small in size as possible. It is important to note that the CPU 4 may also be implemented by a micro-computer, a mini-computer, or any other digital computer device or system, along with the requisite associated memory devices and other necessary and/or selected peripheral devices. The functions of the CPU 4 may also be performed by appropriately integrating the apparatus 1 with the electronic command computer of the vehicle.

It should be noted that the provision of an apparatus 1, which is as small in size as possible, allows for an apparatus which may be more easily installed and concealed in the vehicle, so as to prevent its being located and defeated by a car thief. It is also envisioned that the apparatus 1 may be installed in the motor vehicle during the vehicle's manufacture and/or assembly process so as to insure that it will not be easily detectable or accessible by a car thief. The more concealable the apparatus, the less likelihood that it could be located and defeated. It is envisioned that the apparatus 1 and any associated circuitry and/or wiring, may be designed into the motor vehicle so as to be inaccessible to a thief.

The CPU 4 also has a transmitter 4A associated therewith for transmitting signals to the transmitter system 2 or transceiver. In this manner, the CPU 4 of the apparatus 1 may respond to a user data transmission, command, or inquiry with a transmitted signal which may include digital as well as other data and may also include electronically synthesized voice data which is generated by a voice synthesizer 4B which is connected to the CPU 4 and the transmitter 4A as shown in FIG. 1. The transmitter 4A and optional voice synthesizer 4B may be utilized so as to provide information to an authorized user or operator which may include, but not be limited to, apparatus status, vehicle operation status, and the status of each vehicle system, equipment and/or device which is utilized in conjunction with the apparatus as well as vehicle position data.

The CPU 4 is electrically connected and/or linked to the motor vehicle ignition system 7, which is located externally from the apparatus 1. The CPU 4 may or may not be connected and/or linked with the vehicle ignition system 7 through an ignition system interface 8 which is also shown in FIG. 1. The CPU 4 may transmit signals to, as well as receive signals from, the vehicle ignition system 7. In this manner, the CPU 4 and the vehicle ignition system 7, may exchange information between each other. In this manner, the CPU 4, upon receiving an appropriate signal from the receiver 3, and upon the completion of the requisite data processing routine, which will be described below, may issue an electrical, an electronic, and/or any other suitable signal, including a digital command signal, to the vehicle ignition system 7. This electrical, electronic and/or other suitable signal or digital command signal may be one which will disable the vehicle ignition system 7 or one which will re-enable or reset the vehicle ignition system 7. The CPU 4 may also interrogate the ignition system 7 and/or receive data from the ignition system 7 which is indicative of ignition system status (i.e., whether the ignition system 7 is on or off).

In the preferred embodiment, the CPU 4 is also electrically connected and/or linked to the motor vehicle fuel pump system 9 which is also located externally from the apparatus 1. The CPU 4 may or may not be connected with the vehicle

fuel pump system 9 through a fuel pump system interface 10 which is also shown in FIG. 1. In the case of an electrical or an electronic fuel pump system, the CPU 4 may provide an electrical, an electronic, and/or other suitable signal, including a digital signal, which will disable, re-enable, or reset the vehicle fuel pump system 9.

In the case of a mechanical fuel pump system, the CPU 4 may provide an electrical, electronic, and/or other suitable signal, including a digital signal, which will disable or re-enable an electrical valve system, which may be used to control the operation of the mechanical fuel pump system. Whichever the case may be, the CPU 4 will be capable of issuing an electrical, electronic and/or other suitable signal, including a digital signal, to disable, to re-enable, or to reset the vehicle fuel pump system 9. The CPU 4 may also interrogate and/or receive data from the fuel pump system 9 which is indicative of fuel pump system status (i.e., whether the fuel pump system 9 is on or off). The CPU 4 may also be electrically connected and/or linked to an appropriate device (not shown) for controlling the operation of a vehicle exhaust system device. The vehicle exhaust system device may be a device for blocking the flow of exhaust gases through the exhaust system.

The CPU 4, in the preferred embodiment, is also electrically connected and/or linked to at least one or more of a vehicle equipment system or systems 11. The vehicle equipment system or systems 11 are located externally from the apparatus 1 and may or may not be connected and/or linked to the CPU 4, via a vehicle equipment system or systems interface 12 which may or may not be required for each one of the variety or multitude of the vehicle equipment systems which may be utilized in conjunction with the apparatus.

The vehicle equipment system or systems 11 may include a loud siren or alarm, which may be located in the passenger compartment of the motor vehicle and, which may produce a loud piercing sound so as to make it unbearable for an intruder to remain inside the motor vehicle passenger compartment. The vehicle equipment system 11 may also include an external siren or alarm, which may produce a loud piercing sound, which may be utilized to draw attention to the motor vehicle. The vehicle equipment system 11 may also include a horn, which may blare continuously or intermittently, so as to also draw attention to the motor vehicle. The vehicle equipment system(s) 11 may also include the vehicle external light system(s), which may include the vehicle head lights, tail lights or flashers, which may be constantly illuminated or which may blink on and off repeatedly so as to draw attention to the motor vehicle.

The vehicle equipment system(s) 11 may also include a power door lock system, for securing the vehicle passenger compartment so as to prevent an entry thereunto or an exit therefrom. In addition, the vehicle equipment system(s) 11 may include a hood locking system, such as a mechanical hood locking system, for locking the vehicle hood so as to prevent an unauthorized access into the vehicle engine compartment so as to prevent any tampering with the apparatus 1 or with other systems and/or components of the motor vehicle.

The vehicle equipment system(s) 11 may also include any one or more of the widely known vehicle anti-theft systems and may also include a vehicle recovery system or device, including a homing and/or a tracking device or system, each of which system(s) may be activated and/or controlled by the apparatus 1 of the present invention.

The vehicle equipment system(s) 11 may also include video recording and/or photographing equipment, which

may include video recording device(s) and/or a camera(s), such as those utilized in conjunction with personal computers, televisions, digital televisions, interactive televisions, display telephones, video telephones, and/or other communication devices, including personal communication devices, or a still picture camera(s). The video recording device(s) or camera(s) may be digital recording devices or cameras or other suitable devices or cameras, including typical video recording devices or cameras. The video recording device(s) or camera(s), in a preferred embodiment, has associated therewith a transceiver or transmitter/receiver system for transmitting video images recorded by the video recording device(s) or camera(s) to the user or operator and for receiving signals such as, for example, control signals, by which the user or operator may exercise control over the video recording device(s) or camera(s).

The video recording device(s) or camera(s) may be located at any location on the interior of the vehicle such as, for example, in the dashboard of the vehicle so that the user or operator, or any other authorized individual, may observe and/or photograph the driver of the vehicle, or the occupants and/or cargo of the vehicle. The video recording(s) or camera(s) may also be located on the vehicle exterior. The video recording device(s) or camera(s) may have wide angles for maximum angular viewing and may also be pivotable and/or movable. The video recording device(s) or camera(s) may record and/or transmit the recorded video and/or the picture(s) in real time and/or live. The video recording device(s) or camera(s) may also be equipped with a storage medium, for storing the recorded video and/or picture(s), and a transmitter or transceiver for transmitting the stored video and/or picture(s) to the user or operator at a later time. In this manner, real-time, as well as deferred, video and/or picture(s) transmissions may be provided.

The vehicle equipment system(s) 11 may also include audio recording equipment, which may include audio recording device(s) such as microphones and/or tape recorders, such as those utilized in conjunction with personal computers, televisions, digital televisions, interactive televisions, telephones, cellular telephones, display telephones, video telephones, and/or other communication devices, including personal communication devices. The audio recording device(s) may be digital audio recording devices or other suitable audio devices including typical audio recording devices. The audio recording device(s), in a preferred embodiment, has associated therewith a transceiver or transmitter/receiver system for transmitting the recorded audio to the user or operator and for receiving signals such as, for example, control signals, by which the user or operator may exercise control over the audio recording device(s).

The audio recording device (s) may be located at any location on the interior and/or exterior of the vehicle so that the user or operator, or any other authorized individual, may hear what is transpiring, and/or what has transpired, inside and/or outside the vehicle. The audio recording device(s) may also be pivotable and/or movable. The audio recording device(s) may record and/or transmit the recorded audio in real time and/or live. The audio recording device(s) may also be equipped with a storage medium, for storing the recorded audio, and a transmitter or transceiver for transmitting the stored audio at a later time. In this manner, real-time as well as deferred audio transmissions may be provided.

The vehicle equipment system(s) 11 may also include an intercom system or device or telephone, cellular, digital or otherwise, for providing a means by which to allow the user

or operator, or other authorized operator, to communicate with the operator and/or occupants of the vehicle over a designated communication line.

The vehicle equipment system(s) 11 may also include monitoring device(s) for reading and/or monitoring the vehicle fuel supply, water and/or coolant supply, electrical generator and/or alternator operation, battery charge level, and/or engine temperature level and/or any other vehicle operation and/or system function. The monitoring device(s), in a preferred embodiment, has associated therewith a transceiver or transmitter/receiver system for transmitting data and/or information recorded and/or read by the monitoring device(s) to the user or operator and for receiving signals such as, for example, control signals, by which the user or operator may exercise control over the monitoring device(s).

The vehicle equipment system(s) 11 may also include communication devices, such as two-way radios, radios, televisions, navigational devices and/or equipment, fire extinguishing equipment, radar devices and equipment, emergency and/or distress signal equipment, and any electrical, electronic and/or otherwise activated appliances and/or equipment which may be utilized in a vehicle. Appliances may include household appliances such as refrigerators, stoves, air conditioners, ovens, microwave ovens, lighting systems, etc. The vehicle equipment system (s) 11 may also include electrical and/or electronically controlled dead bolt locking devices for use on doors, windows, hood, trunk and/or in conjunction with any other opening components and/or components for gaining access to various locations on and/or in the vehicle.

The vehicle equipment system(s) 11 may also include a wheel and/or brake locking device or mechanism. The vehicle equipment systems may also include hydraulic and/or pneumatic equipment and/or other equipment, including winches, etc, which may be remotely activated as described herein. The vehicle equipment system(s) 11 may also include vehicle communication devices including, but not limited to radios, televisions and entertainment devices, two-way radios, cellular telephones and equipment, etc. The vehicle equipment system(s) 11 may also include systems for detecting failures in any of the above, or any other, equipment systems and report such failure(s) to the user or operator whether he or she is operating the vehicle or is not in the vehicle and/or for reporting such failures to a central office.

In the case of commercial and/or farm and/or construction equipment, the vehicle equipment system(s) 11 may also include loading and/or unloading mechanisms, cutting mechanisms, bailing mechanisms, winches and any and all of the various systems and devices utilized in conjunction with these vehicles and/or equipment.

As noted above, the use of any one or more of the vehicle equipment system or systems 11, and their associated interface devices 12, may be optional and may further include any other systems and/or devices which may, or are, utilized in and/or in conjunction with any of the above noted or envisioned vehicles. The vehicle equipment system(s) 11, especially when the apparatus is utilized in conjunction with law enforcement and/or military vehicles, may also include guns and/or weapon systems and/or self defense systems and electronic warfare systems.

The vehicle equipment system or systems 11 receives signals from the CPU 4, which signals serve to activate or de-activate, or vice versa, whichever the case may be, the respective vehicle equipment system(s) 11 which are utilized in conjunction with the apparatus 1. The vehicle equipment

system(s) 11 may also include any other suitable vehicle system or equipment, device or feature which may be utilized to draw attention to the motor vehicle and/or in some other way impede the vehicle theft. It should be noted that any of the interface devices 8, 10 and 12 may include any of the requisite interfacing circuitry which may be necessary to facilitate CPU 4 control over the respective systems which may be utilized.

The apparatus 1 also comprises a vehicle position and locating device 13 which may be utilized in order to determine the position and/or the location of the vehicle. The vehicle position and locating device 13 can be utilized so as to determine the position of the vehicle anywhere in the world and provide for the transmission of vehicle position and/or location data to any appropriate system receiver so that the vehicle may be located and/or tracked and recovered. In the preferred embodiment, the vehicle position and locating device 13 comprises and utilizes a global positioning device and an associated transmitter for transmitting position and/or location data to the authorized user or operator and/or to an authorized office or agency authorized to receive and/or to monitor such data transmissions.

The apparatus 1 also comprises a vehicle position and locating system receiver 14, which may be employed by the authorized user or operator and/or by the authorized office or agency, for receiving and/or processing the data which is transmitted from the vehicle position and locating device 13 as will be described in more detail hereinbelow. The apparatus 1 may also comprise a corresponding user interface device (not shown) for use in conjunction with the vehicle position locating system.

While the preferred embodiment, as illustrated in FIG. 1, describes certain connections between various components and/or devices of the apparatus as being made by a direct and/or a wired electrical connection, it is noted that any direct and/or wired electrical connection(s) between any of the components and/or devices described herein, may be replaced with wireless devices, wireless communication devices, equipment, links and/or linkups, along with their respective and associated technologies and/or devices, which wireless devices and technologies are known and the teachings of which are incorporated by reference herein.

FIG. 2 illustrates the vehicle position and locating device 13 of FIG. 1 illustrating the main components thereof in block diagram form. The vehicle position and locating device 13, in the preferred embodiment, comprises a positioning system computer 21 and a global positioning device 22 with associated global positioning system receiver 23. The positioning system computer 21 comprises a central processing unit (CPU) (not shown) and associated read only memory (ROM) device (not shown) and random access memory (RAM) device (not shown).

The vehicle position and locating device 13 also comprises a position data transmitter 24, for transmitting the vehicle position and/or location data to the vehicle position system receiver 14. The vehicle position and locating device 13 also comprises a data base 25 which contains digital and/or digitized map data, which can be utilized to determine the geographical position of the vehicle from the calculated "raw" position data obtained from the global positioning device 22. In this regard, vehicle location on a map and/or street location may be obtained.

As will be described in more detail below, the positioning system computer 21 controls the operation of the vehicle position and locating device 13, including the operation of the global positioning device 22. The global positioning

system receiver 23 receives the necessary signals from the global positioning satellites and/or satellite system(s) which are located in orbit above and around the earth. The signals which are received by the receiver 23 are processed by the global positioning device 22, in a manner which is well-known to those skilled in the global positioning art. Once the vehicle position data or "raw" data is calculated, the data is transmitted to, or read by, the positioning system computer 21.

Vehicle position and/or location data can then be transmitted to the vehicle position system receiver 14 which may be located at, or accessible to, the authorized user or operator and/or at the location of an authorized office or agency, such as at a central security office or agency or local or regional law enforcement office or agency, which is duly authorized to receive the vehicle position and/or location data for the vehicle.

Vehicle position and/or location data is transmitted by the transmitter 24 which, in the preferred embodiment, is a radio signal transmitter or a broadcast transmitter. The transmitter 24 may also be a cellular or mobile telephone or wireless or other communication device which is programmed to call and transmit the data to the vehicle position system receiver 14. The transmitter 24 may also be a digital signal transmitter or any other suitable transmitter. The global positioning data could also be obtained by the user or operator by directly "calling" the system receiver 14 and/or the CPU 4 of the apparatus 1.

In the preferred embodiment, the transmitter 24 comprises a radio signal transmitter for transmitting vehicle position and/or location data to the vehicle position system receiver 14, which may be at a location of the authorized user or operator and/or at a central security office or agency or at a local or regional law enforcement office or agency as will be described in more detail hereinbelow. In this regard, the vehicle position system receiver 14 comprises a radio signal receiver which is tuned to receive the signals which are transmitted by the transmitter 24. If the transmitter 24 is a cellular or mobile telephone or other personal communication device, the system receiver 14 could be equipped with an associated cellular or mobile telephone or personal communication device or other suitable device, which can be used in conjunction with the cellular or mobile telephone transmitter. Digital communication transmitter/receiver combinations and/or transceivers may also be utilized.

The vehicle position and locating device 13 may also have its operation programmed so as to perform updated global positioning calculations, continuously, intermittently, at regular intervals and/or in any other suitable manner, so as to provide for a tracking of a vehicle movement. The vehicle positioning system computer 21, in the preferred embodiment, contains digital and/or digitized map data stored in database 25 for ascertaining the geographical position of the vehicle from the calculated global positioning data ("raw" data) which is calculated by the global positioning device 22. In this manner, the calculated global positioning data, and/or processed geographical position data, can be provided for ascertaining vehicle position and/or location and, if appropriate, for ascertaining vehicle movement such as by monitoring and/or tracking vehicle position as it is updated.

The vehicle position system receiver 14 may be equipped with an appropriate computer system which also comprises a digital and/or digitized map database for determining geographical location (i.e. map location, street location, or any other data which may be correlated and/or processed

with the positioning data, etc.), from the received global positioning data, at the location of the receiver 14. The system receiver 14 may also be equipped with an alphanumeric pager device which can simply receive the position data and/or the geographical position data from an appropriately designed transmitter 24.

FIG. 3 illustrates the vehicle position and locating system receiver 14 of FIG. 1 illustrating the components thereof in block diagram form. In FIG. 3, the system receiver 14 comprises a receiver 30 for receiving the data transmitted by the transmitter 24 of the vehicle position and locating device 13. In the preferred embodiment, the receiver 30 may be a radio signal receiver, a telephone, telecommunication and/or other system receiver, depending upon the type of transmitter which utilized for the transmitter 24. It is also important to note that the receiver 30 may be a personal communication system or personal communication services (PCS) receiver or device. The receiver 30 may also be a satellite dish receiver or a digital signal receiver.

The vehicle position and locating system receiver 14 also comprises a computer 31 for controlling the operation of the system receiver 14. The positioning system receiver computer 31 comprises a central processing unit (CPU) (not shown) and associated read only memory (ROM) device(s) (not shown) and random access memory (RAM) device(s) (not shown). The computer 31 is connected to the receiver 30 for receiving and/or for reading the vehicle position and/or location data which is transmitted by the transmitter 24 and received by the receiver 30. The system receiver 14 also comprises a user interface device 32, which may include a keyboard or a pointing device such as a mouse, a display device 33 such as a display monitor, an output device 34 such as a printer and a database 35 such as a data base containing digital and/or digitized map data for use in determining geographical position of a vehicle from the "raw" position data. The system receiver 14 may also comprise a transmitter 36 for sending data and/or signals to the vehicle position and locating device 13 and/or for transmitting signals to the CPU 4 and/or to the transmitter receiver 2C.

It is important to note, at this point, that the system receiver 14 may also be implemented by utilizing a home and/or a personal computer which may be utilized with an associated receiver 30 or equivalent peripheral device(s). In the case of a home and/or a personal computer, the data received from the vehicle position and locating device 13 may be input into the computer, from the receiver 30, by any one of the well known methods and techniques for inputting data into a home and/or a personal computer from such an appropriate peripheral device(s). In cases wherein a telephone signal and/or a personal communication device or personal communication services (PCS) devices are utilized, a fax/modem or other suitable device may be utilized to send, and/or to receive, data to, and from, the vehicle position and locating device 13. A television, appropriately equipped to receive and/or to transmit signals may also be utilized. It is also envisioned that digital televisions, interactive televisions, personal communications devices, personal communications services (PCS) devices, personal digital assistants, display telephones, electronically equipped watches, cellular telephones and/or display cellular telephones may also be utilized.

It is also important to note that the transmitter system 2 or transceiver and the vehicle position and locating system receiver 14 may be implemented by utilizing, and therefore replaced by, a home and/or a personal computer having the configuration illustrated in FIG. 4. FIG. 4 illustrates a block

diagram of a computer system which provides all of the functions of, and/or for, the transmitter 2 or transceiver and the vehicle position and locating system receiver 14. In FIG. 4, the home and/or personal computer, which is denoted by the reference numeral 150 comprises a CPU 151 with associated read only memory (ROM) device 161 and random access memory (RAM) device 162, a user interactive or interface device 152 which includes a keyboard and/or a pointing device, a display device 153 which may be a display monitor, an output device 154 which may be a printer, and a database 155 which may contain access code and command code data as well as digital and/or digitized map data.

The computer 150 also comprises a transmitter 156 for transmitting data to the receiver 3 and/or the CPU 4 and a receiver 157 for receiving data from the receiver transmitter 3A and/or the CPU 4. The computer 150 also comprises a receiver 158 for receiving data from the vehicle position and locating device 13 and a transmitter 159 for transmitting data to the vehicle position and locating device 13. In the embodiment of FIG. 4, data may be transmitted to and received from the computer 150 by using any of the conventionally known communication systems such as by utilizing radio signal communication devices, telecommunication devices, optical communication devices, satellite communication devices, and/or personal communication devices and/or personal communication services (PCS) devices, or any other suitable communications devices, including any of the types of devices described above. In the case of telecommunication devices, a fax/modem for sending and receiving data may be utilized in the computer 150. Digital communication devices may also be utilized.

FIG. 5A illustrates the apparatus of FIG. 1 wherein the computer 150 of FIG. 4 is utilized as a substitute device for, and for performing the functions of, the transmitter 2 or transceiver and the vehicle position and locating system receiver 14.

It is also envisioned that the apparatus 1 may be utilized in conjunction with a computer so that the authorized user or operator can utilize the apparatus over an on-line service and/or on, or over, the Internet and/or the World Wide Web and/or other suitable communication network or medium.

FIG. 5B illustrates an alternate embodiment wherein the apparatus 1 is utilized in conjunction with an on-line service and/or on, or over, the Internet and/or the World Wide Web and/or other suitable communication network or medium. In FIG. 5B, the various transmitters of the apparatus 1, including the receiver transmitter 3A, the CPU transmitter 4A and the vehicle position and locating device transmitter 24, transmit their respective data transmissions to a receiver 500 associated with an on-line service or internet computer system or computer server 510 (hereinafter "server") which is specifically dedicated to the task of providing control over and/or monitoring the vehicle, the apparatus 1 and/or any one or more of the vehicle systems which are controlled and/or monitored by the apparatus 1. The server 510 can also perform vehicle monitoring, tracking and/or recovery functions. The server 510 also has associated therewith, and connected and/or linked thereto, a receiver 511 and a transmitter 512, for receiving and transmitting, respectively, all of the respective signals utilized for the complete and effective operation of the apparatus 1. The server 510 may be utilized in conjunction with an associated Web Site 520.

In the embodiment of FIG. 5B, the authorized user or operator may transmit data directly to the apparatus 1 via the home and/or personal computer 150. The authorized user or

operator may also transmit data directly to the server 510 over an appropriate communication network or medium.

By using the computer 150 in conjunction with an appropriate communication medium, the authorized user or operator may then access the dedicated server 510 such as on-line and/or via the Web Site 520 and thereby receive any and all of the above-described data from the server 510 over the on-line service and/or on, or over, the Internet and/or the World Wide Web and/or other suitable communication network or medium. The authorized user or operator may also enter command codes and other data so as to provide control over the apparatus 1 via the server 510. The dedicated server 510 may be accessed via the associated Web Site 520. The dedicated server 510 may also process the data obtained by the apparatus 1 in any appropriate manner, if desired. The authorized user or operator may also access and provide control over the apparatus 1 via the server 510.

Applicant also hereby incorporates by reference herein all of the methods and/or techniques for providing information and/or data over on-line services and/or on, or over, the Internet and/or the World Wide Web or other suitable communication network or medium, along with client/server and/or Web Site technology and methods and/or techniques utilized in conjunction therewith, which are known as of the filing date of this application. In this regard, the authorized user or operator may utilize the apparatus to its fullest capabilities over an on-line service and/or on, or over, the Internet and/or the World Wide Web or other suitable communication network or medium. In this manner, the embodiment of FIG. 5B may allow the authorized user or operator to utilize the apparatus and/or to monitor the operation of the apparatus over the on-line service and/or on, or over, the Internet and/or the World Wide Web from any suitable computer and/or from any location.

The operation of the apparatus 1 of the present invention is described below with reference to the flow diagram illustrated in FIG. 6, which flow diagram illustrates a preferred embodiment method for utilization of the apparatus 1. The method of the present invention may be implemented as a computer program or software program which is utilized in conjunction with the CPU 4. The computer program or software program may be programmable so as to provide for the modification of same, if desired.

Upon the occurrence, or the discovery thereof, of the theft of a motor vehicle, or simply to monitor vehicle status or location, the authorized user or operator of the vehicle may activate the apparatus 1 by entering an access code into the transmitter interface 2A which, as noted above, may be a touch tone telephone keypad. The entry of a valid access code will activate a signal transmission from the transmitting device 2B in a manner similar to that of making a telephone call. In the preferred embodiment, the above sequence of events may occur by the authorized user or operator simply utilizing a touch-tone telephone, which may be a public pay telephone, a private telephone, a line telephone, a cordless or wireless telephone, or a cellular or mobile telephone, and by entering in the predetermined access code which is assigned to the particular apparatus 1.

In the case of a touch-tone telephone/telephone beeper or pager system, wherein the beeper or pager is the receiver 3 in the apparatus 1, this access code would typically be a code which would comprise a given telephone area code and telephone number assigned to, or programmed for, the beeper or pager (receiver 3).

Upon receiving the transmitted signal, the receiver 3, or beeper or pager, or the communication system servicing the

beeper or pager, will typically generate, via transmitter 3A or by another appropriate device, which may or may not be an integral part of the receiver 3, a signal, electrical or otherwise, which is indicative of the receiver 3 having received the signal from the transmitter 2 and which further indicates that the receiver 3 has been accessed. In the case of a communication system or service which services the beeper or pager, the transmitter 3A may be located externally from the apparatus 1 and may be linked to the receiver 3 via the communication link which services the receiver 3 (i.e., the beeper or pager communications service system).

The received access signal is also sent to, or read by, the CPU 4 so as to alert the CPU 4 that the receiver 3, and the apparatus 1 have been accessed. The receiver 3, or the communication system servicing the receiver (beeper or pager), will then transmit a signal, via its transmitter 3A, to the transmitter receiver 2C which is indicative of the fact that the receiver 3, and the apparatus 1, have been accessed. This signal which is transmitted to the transmitter receiver 2C usually takes the form of an audible tone at the telephone headset which typically occurs when it is desired to communicate with a beeper or pager device.

The above sequence is analogous to the operation of a telephone/telephone beeper or pager system wherein, when the beeper or pager, or the communication system servicing the beeper or pager, has answered the call, the beeper awaits entry of a telephone number or code by the caller. The signal indication by the receiver 3 will then be followed by a period of silence during which period, the authorized user or operator may enter the desired command code data or command code, which may include a vehicle disable command code, a vehicle re-enable or reset command code, a cancel code, or any other suitable command code by which the authorized user or operator may exercise control over the apparatus 1. The authorized user or operator may then enter the code or number sequence into the transmitter interface 2A or, in this case, the telephone keypad.

In a case when the motor vehicle has been stolen, the command code may be a vehicle disable command code. It should also be noted that a vehicle re-enable or reset command code, or any other suitable command code, which would represent a function or operation to be performed by the apparatus 1, may also be entered, as the circumstances may require, at this time. The command code is then transmitted from the transmitting device 2B of the transmitter system 2 and is received by the receiver 3 or beeper or pager. In the preferred embodiment, a command code received signal is then transmitted back to the transmitter system 2, via the receiver 3, or communication system, transmitter 3A, which provides an indication, to the authorized user or operator, that the command code has been received by the apparatus 1.

The command code data is then transmitted to, or read by, the CPU 4 for command code identification and for further processing, if necessary. In this manner, an authorized user or operator, upon learning of the theft of the vehicle, or simply attempting to ascertain the status and/or location of the vehicle, may easily access or activate the apparatus 1 by simply utilizing the nearest touch-tone telephone and by "calling up" the apparatus 1.

It is important to note that the telephone/telephone beeper system, described above, may be replaced with any remote transmitter/receiver system, such as by a remote transmitter, i.e., a television-type remote control unit, which control unit would require a user interface feature and which has the capability to remotely transmit a multitude of signals over

long distances to an associated receiver. A two-way pager, or other appropriate two-way communication device may also be utilized. A home and/or personal computer, with requisite peripheral devices, a personal communication device and/or a personal communication services (PCS) device may also be utilized. Digital communications devices, interactive televisions and/or digital televisions may also be utilized. It is also envisioned that digital televisions, interactive televisions, personal communications devices, personal communications services (PCS) devices, personal digital assistants, display telephones, video telephones, electronically equipped watches and/or other effects or accessories, cellular telephones, display cellular telephones may also be utilized.

By utilizing a telephone/telephone beeper or pager system, in the preferred embodiment, a long range, remote-controlled system may be achieved which systems are usually very well maintained by telecommunication companies or carriers and are also very reliable. By using a telephone/telephone beeper or pager system, the authorized user or operator does not have to keep track of a separate remote control unit. In this manner, a reliable and efficient apparatus communication system is achieved. The apparatus 1 may also be equipped with an alternate and/or an auxiliary transmitter device(s), such as a remote control unit or home and/or personal computer system, which could be employed in addition to a telephone. In this manner, if the authorized user or operator should leave the remote control unit in the vehicle, or should lose it, the apparatus 1 may still be accessed by the authorized user or operator. Still further, some telephone/telephone beeper or pager systems may have effective distance ranges on the order of hundreds or thousands of miles which may be economical and reliable for long range signal transmission.

In the case where the motor vehicle has been stolen, and the authorized user or operator wants to prevent or thwart the theft of the vehicle and recover the vehicle, the command code which is to be entered is a vehicle disable command code (disable code) which will disable the vehicle in the manner described below. Similarly, if the authorized user or operator desires to re-enable or reset the apparatus 1, such as when the motor vehicle has been recovered or found, so as to render the vehicle re-enabled or operational, the command code to be entered will be a vehicle re-enable or reset command code (re-enable or reset code).

Once the command code has been entered, the receiver 3, via its transmitter 3A, may provide a signal indication to the transmitter system 2, which may take the form of audible tones to a headset, such as is known in beeper or pager systems, which serve to confirm receipt of the command code by the receiver 3 and the apparatus 1. The data entered into, and transmitted from, the transmitter system 2, and received by the receiver 3, will then be transmitted to, or read by, the CPU 4 for command code identification and for subsequent processing, if necessary.

If the authorized user or operator merely wants to determine the status of the vehicle and/or of any of the vehicle equipment systems (i.e., is the ignition system on, is the engine running, is a burglar alarm system armed, etc.), a status code may be entered and the CPU 4, after monitoring the vehicle systems, may report back to the authorized user or operator via the receiver transmitter 3A or the CPU transmitter 4A. If the authorized user or operator wants to determine the location of the vehicle and/or if it is in motion, a location request code may be entered whereupon the vehicle position and locating device 13 may be actuated so as to determine vehicle position and/or location data, which

data may then be transmitted to the user or operator via transmitter 24. The CPU transmitter 4A may also transmit vehicle portion data as the CPU 4 may also have access to said data. In this manner, the user or operator may exercise control over the vehicle and/or monitor the operational status and/or state of the vehicle and/or of any of the vehicle systems and/or components. The user or operator may also monitor the position and/or movement of the vehicle.

FIG. 6 illustrates a flow diagram of a preferred embodiment of the operational steps and/or sequence of operation of the apparatus and method of the present invention. With reference to FIG. 6, the receiver 3, upon receipt of the access code, will generate an interrupt in the CPU 4 which will activate an operational program or an interrupt service routine, at step 60, of the flow diagram. At step 61, the command code data is received by the apparatus 1. Upon receipt of the command code by the receiver 3, the command code is then transmitted to, or read by, the CPU 4 at step 62. The CPU 4 will then, at step 62A, perform a processing routine in order to identify the command code which has been entered.

In the preferred embodiment, the command code should be of a pre-determined length and should be chosen to be one of a variety of codes which may be chosen so as to provide for the controlling of the apparatus 1 to perform any number of functions and/or to control the vehicle and/or any of the vehicle systems utilized in conjunction with the apparatus 1. The command code may be a valid disable code, a valid re-enable or reset code, a cancel code, a vehicle status code, a vehicle position and locating code, or any other suitable code which may be recognized by the CPU 4 so as to provide control over and/or monitoring of the apparatus 1. A command code may be utilized to indicate a cancel operation, or to identify a previous transmission as a false alarm. An incomplete code, an invalid code, or the absence of a command code after the apparatus 1 has been accessed, may be deemed to be a false alarm.

The cancel and false alarm categories are utilized in order to enable an authorized user or operator to cancel access to and/or activation of the apparatus 1, or to prevent an unauthorized access or unauthorized attempt to enter a command code into the apparatus 1. Such an identification processing routine may be performed in a very simple manner, such as by testing the command code or code data against pre-determined or pre-defined codes and/or against any other code data which may be stored in apparatus program memory. Such testing may be performed by any one of the widely known software testing and identification routines and/or techniques.

At step 63, the CPU 4 will determine if the code is a valid code. If the code is valid, then the processing will proceed to step 64. If the code is invalid, the CPU 4 will return to step 76 thereby exiting the operational program or interrupt service routine and the apparatus 1 will await a next access code and command code transmission. Once a valid command code has been entered, the CPU 4, at step 64, will determine if a valid disable code has been entered, which disable code signifies that the car has been stolen and/or is under the control of an unauthorized user or operator or simply that the authorized user or operator wishes to render the vehicle inoperative. Once the command code, if entered, is identified, the CPU 4, under the control of the apparatus operational program or interrupt service routine, will perform the appropriate apparatus control functions.

If a valid disable code is identified as having been transmitted, at step 64 (which may designate that the vehicle

has been stolen), the CPU 4 will initiate and/or actuate the operation of the vehicle position and locating device 13 at step 65. The vehicle position and locating device 13 will then begin to, and continue to, perform the necessary routines in order to determine vehicle position and/or location as will be described below. The operation of the vehicle position and locating device 13 will proceed and continue simultaneously and/or concurrently with the operation of the apparatus 1 and the CPU 4 as described below.

The CPU 4, which is connected to the vehicle ignition system 7, so as to send and receive data to and from the vehicle ignition system 7, will perform a software test, at step 66, in order to determine whether the vehicle ignition system 7 is activated or is on (i.e. the vehicle is operating or is in motion). This will require a monitoring of the vehicle ignition system 7 by the CPU 4.

As noted above, a vehicle ignition system interface 8 is optional and may or may not be employed in order to facilitate this function of monitoring and controlling the vehicle ignition system 7 by the CPU 4.

If the vehicle ignition system 7 is determined to be activated or on, the CPU 4 will enter into a delay loop, at step 67. The purpose of the delay loop, at step 67, is to prevent the vehicle ignition system 7 from being de-activated or shut-down while the vehicle engine is still on or running. Such a test and delay loop routine serves to prevent accidents and resulting personal injury and property damage, such as may be caused when a vehicle suddenly loses power while in motion and/or is travelling at a moderate, or at a high, rate of speed or when such a loss of engine power may result in the failure of the vehicle power steering and/or power brake systems. In this manner, the CPU 4 will continue to interrogate the vehicle ignition system 7 after a pre-determined delay period, and will continue to do so until the vehicle ignition system 7 is determined to be shut-off and/or is non-operational.

While any delay period may be employed, at step 67, and may be programmed into the program software of the apparatus 1, it is important to choose a delay period which can detect even the shortest duration of a vehicle ignition system shut-down. In the preferred embodiment, a delay period of one (1) second is utilized. This delay period, of course, may be changed in the program software, as desired, by utilizing known system programming methods and/or techniques.

After the delay period has elapsed, at step 67, the CPU 4 will again interrogate the ignition system 7, at step 66, and will continue to do so in the above described delay loop routine until the ignition system 7 is determined to be shut-off and/or is non-operational. Once it has been determined that the vehicle ignition system 7 is shut-off and/or is non-operational, the CPU 4, at step 68, will issue a disable signal to the vehicle ignition system 7.

The disable signal which is issued by the CPU 4, at step 68, will disable the vehicle ignition system 7, thereby preventing a restarting of the vehicle engine. The disabling function may be performed by the CPU 4 by issuing a data signal, which causes the vehicle ignition system circuitry to be shut-off or be "opened", such as by opening a switching device and/or a series of switching devices (i.e. a switch or relay (not shown)), which is or are located in, or designed into, the ignition system circuitry, the starter motor, or at any other location in the ignition system 7, or by issuing a disabling signal to the digital or logic devices, which may be utilized in connection with the vehicle electronic command computer and/or other electrical components or systems.

It should be noted that any number of methods may be used, in conjunction with the apparatus 1, for disabling the vehicle ignition system 7. The CPU 4 can be utilized to provide control signals, to disable or re-enable, the vehicle ignition system 7 just as any microprocessor-based digital system provides control over the operation of the components and/or peripheral devices utilized in conjunction therewith. The techniques utilized, in order to provide such control over the vehicle ignition system 7 may be determined on a vehicle-by-vehicle basis.

Once the vehicle ignition system 7 has been disabled, only the issuance of a valid re-enable or reset command code, to the apparatus 1, may be utilized to re-enable or reset the vehicle ignition system 7. In this manner, a carefully concealed and installed placement of the apparatus 1, within the vehicle, will provide for a completely disabled vehicle until such time as a valid access code, followed by a valid re-enable or reset command code, is entered by the authorized user or operator in a manner consistent with the operation of the apparatus 1. As can be readily appreciated, a carefully concealed apparatus 1, along with a strategically placed ignition cut-off circuitry or system, would render it most difficult, if not impossible, for the thief or thieves to practically defeat the apparatus 1.

With reference once again to FIG. 6, the CPU 4, at step 69, will then issue a disabling signal to the vehicle fuel pump system 9 thereby de-activating the vehicle fuel pump system 9 and prohibiting the supply of fuel to the vehicle engine. The disabling signal from the CPU 4 can disable the vehicle fuel pump system 9 by any one of the well known methods for disabling a fuel pump system. In the case of electric fuel pump systems, said systems may be disabled by any one of the known methods for shutting-off or "opening" an electrical circuit which provides power to, or control over, the fuel pump system 9, such as by a cut-off switch or relay, which methods and/or techniques may be similar to and/or analogous to those methods and/or techniques utilized in connection with disabling the vehicle ignition system 7.

In the case where electronic components are utilized, the digital components or logic gates in the control circuitry may also be disabled. In the case where a mechanical fuel pump is utilized, an electric valve assembly, which may provide a fuel pump operation cut-off or disconnect, may also be utilized thereby allowing any appropriate method for disabling an electrical fuel pump system to be utilized in order to disable the electric valve assembly, and ultimately, to shut-off or disable the mechanical fuel pump system. The vehicle fuel pump system interface 10 may be utilized, if necessary, in order to facilitate the above described disabling technique(s).

The CPU 4 can be utilized in order to provide control signals to disable or re-enable the vehicle fuel pump system 9 just as any microprocessor-based digital system provides control over the operation of components and peripheral devices utilized in conjunction therewith. It should be noted that the techniques utilized in order to provide control over (disable or re-enable) the vehicle fuel pump system 9 may be determined on a vehicle-by-vehicle or fuel pump-by-fuel pump basis.

Upon the disabling of the vehicle ignition system 7, at step 68, and/or the vehicle fuel pump system 9, at step 69, the CPU 4, at step 70, if so commanded, will then issue a control signal(s) to activate or de-activate, whichever the case may be, any one or more of the various vehicle equipment systems 11 which are utilized in conjunction with the apparatus 1. As noted above, the vehicle equipment

system(s) 11, if employed, may include an alarm or siren, which has a piercing sound and which is placed in the interior of the passenger compartment. The alarm or siren would serve to make it unbearable for the thief or thieves to remain inside the vehicle. External alarms or sirens may also be utilized in order to draw attention to the vehicle. A horn or horns, which could blare continuously or intermittently, could also be utilized to draw attention to the vehicle.

A vehicle light system, i.e. head lights, tail lights, parking lights, etc. may also be activated so as to illuminate continuously or intermittently, such as by blinking, in order to draw attention to the vehicle. Other vehicle equipment systems, such as a power door locking system, may be activated, immediately or after a delay, for securing the vehicle passenger compartment so as to prevent an entry thereunto or an exit therefrom. It is also envisioned that there may be a delay between the disabling of the vehicle ignition system 7 and the activation of the power door lock system so as to allow the thief or thieves to get out of the car before the locking operation takes place.

It is also envisioned that a mechanical hood locking system may be utilized and activated so as to lock the hood and prevent an unauthorized access into the vehicle engine compartment. Such a vehicle hood locking feature could prevent tampering with the apparatus 1 or with other systems and/or components of the vehicle. A vehicle alarm system or anti-theft system(s), such as any one or more of the well known types of anti-theft and/or theft deterrent systems or devices may also be activated, and/or de-activated, when and if desired, by the CPU 4. The CPU 4 may also activate a vehicle homing and/or tracking or recovery device system such as a LoJackO Stolen Vehicle Recovery System and/or any other type of vehicle recovery system.

Any one or more of the above-described vehicle equipment system(s) 11 which may include a power door lock system, including electronic and/or electrical dead bolt locking devices, for securing the vehicle passenger compartment, hood or trunk, so as to prevent an unauthorized entry thereunto, video recording equipment, for recording and supplying video information, and/or audio recording equipment, for recording and supplying audio information, may also be activated or deactivated.

The CPU 4 can be utilized in order to provide control signals to activate and/or to de-activate any one or more of the vehicle equipment systems 11 just as a microprocessor-based digital system provides control over components and/or over peripheral devices utilized in conjunction therewith. Such methods and/or techniques may be similar to those methods and/or techniques utilized to provide control by the CPU 4 over the vehicle ignition system 7 and the vehicle fuel pump system 9. It should be noted that the techniques utilized, in order to provide control over any of the vehicle equipment system(s) 11, may be determined on a vehicle-by-vehicle and/or system-by-system basis. It is also envisioned that a vehicle exhaust system may be de-activated and/or similarly controlled by the apparatus 1.

Once disabled, the vehicle ignition system 7, and the vehicle fuel pump system 9, will remain disabled even if the vehicle power supply should be drained. This is due to the fact that the digital circuitry, which is utilized in the apparatus 1, in the vehicle ignition system 7, in the vehicle fuel pump system 9, and/or in any of the vehicle equipment system(s) 11, may include digital "memory" devices such as logic gates, flip-flops, etc. and/or electro-magnetic devices, such as switches or relays, which may be chosen so as to

remain in their state unless altered or activated in a pre-defined fashion, electrically, electronically or otherwise, or under the power of an electrical signal or stimulus which is controllable only by an authorized user or operator. Further, even if the vehicle power is completely drained, these above mentioned devices, which may be chosen so as to require a predefined application of electrical or electronic power in order to change their state, or their operating mode or operation, would have their re-activation prevented, and thus, the vehicle ignition system 7, the vehicle fuel pump system 9, and/or any of the vehicle equipment system(s) 11, will remain in a disabled state.

It is also envisioned that back-up and/or supplemental power supplies, such as batteries, etc., (not shown) may also be utilized in conjunction with the apparatus 1 so as to prolong the continued activation or de-activation of the vehicle ignition, fuel pump and/or any of the vehicle equipment system(s) 11 which are utilized. Supplemental power systems are optional and may also be employed with the apparatus 1 so as to provide power for any unusual power requirements which may be required by the vehicle in which the apparatus 1 may be installed. The back-up and/or supplemental power supplies may also be solar powered and/or be constantly chargeable by a vehicle recharging and/or alternator system.

Upon the completion of apparatus 1 operation, at step 70, the CPU 4 will then exit the operational program or interrupt service routine at step 76. This signifies the completion of the operational program or interrupt service routine in the case of receiving a disable command code. The CPU 4 will then await the next accessing and/or activation of the apparatus 1 by the authorized user or operator, via entry of a valid access code into the transmitter system 2 as described above. Unless a valid access code, followed by a valid re-enable or reset command code, is entered into the transmitter interface 2A, the vehicle ignition system 7, and the vehicle fuel pump system 9, will remain disabled and/or any of the utilized vehicle equipment system(s) 11, will remain in their activated or de-activated states.

Upon the vehicle being found or recovered, such as in a manner resulting from utilizing the vehicle position and locating device 13, in the manner described hereinbelow, the authorized user or operator may once again access the apparatus 1 by entering the valid access code into the transmitter interface 2A and then by entering the valid re-enabling or reset command code. As described above, a valid access code will once again initiate the operation of the operational program or interrupt service routine, at step 60, which is described above and illustrated in FIG. 6. The valid re-enable or reset command code will then be received by the receiver 3, in the manner described above at step 61.

The command code data will then be transmitted to, or read by, the CPU 4, at step 62 and processed and identified at step 62A. The CPU 4, at step 63, will then determine whether the re-enable or reset command code, which was entered, is a valid code. The CPU 4, at step 64, will then determine if the command code is a valid disable code. Since a valid re-enable or reset code has been entered, the CPU 4 will determine that the command code is not a disable code. The CPU 4 will then proceed to step 71 and will determine whether the command code is a valid re-enable or reset command code.

If the command code is not a valid re-enable or reset command code, the CPU 4 will exit the operational program or interrupt service routine, at step 76, and will await entry of the next valid access code and command code. It should

be noted that, as an added security measure, the apparatus 1 may be programmed so that, upon the receipt of one or more invalid access and/or command codes, the apparatus 1 may require that the authorized user or operator re-program a new access code for the apparatus 1 through a central office or agency or maintenance service which provides service and/or maintenance for the apparatus 1. In any event, the apparatus 1 may be accessed by a valid access code with such accessing resetting the apparatus 1 and initiating the operation of the apparatus 1.

If, however, the entered command code is identified as a valid re-enable or reset code, at step 71, the CPU 4, subsequent to such determination, but prior to actually re-enabling or resetting the vehicle ignition system 7, re-enabling the vehicle fuel pump system 9, and de-activating or re-activating, whichever the case may be, any one or more of the various vehicle equipment systems 11 which are utilized, will perform a test, at step 72, in order to verify that the vehicle ignition system 7 is, in fact, still disabled. If, at step 72, the vehicle ignition system is still enabled or on, the CPU 4 will exit the operational program or interrupt service routine and will await entry of the next valid access code and command code. This test, at step 72, is a safety feature which serves to ensure that no re-enabling or resetting signal will be issued by the apparatus 1 if the vehicle ignition system 7 is not disabled. In this manner, the operation of the vehicle ignition system 7 will not be interrupted or affected, which interruption may be unsafe if the vehicle is already in operation or in motion.

It should be noted that neither the vehicle fuel pump system 9 nor any of the various vehicle equipment systems 11 which may be utilized, should have their status of operation altered as any interruption of the status quo of each of the respective systems, during normal vehicle operation, may also be unsafe.

If the vehicle ignition system 7 is determined to be disabled, at step 72, the CPU 4 will, at step 73, issue a control signal which will re-enable or reset the vehicle ignition system 7. This may be accomplished by any method and/or technique which would re-enable or re-activate the vehicle ignition system circuitry. The CPU 4, at step 74, will then issue a control signal to re-enable or reset the vehicle fuel pump system 9, if so desired, which may also be accomplished by re-enabling or re-activating the vehicle fuel pump system circuitry.

The CPU 4 will then, at step 75, issue control signals to each of the various vehicle equipment systems 11 which are utilized, so as to de-activate or re-activate the respective system(s) which had been activated or de-activated, respectively, earlier at step 70 or otherwise. Upon the completion of the above-described events, the vehicle will then be ready for operation, barring any need for service and/or for repairs. The CPU 4, upon the completion of step 75, will then exit the operational program or interrupt service routine, at step 76, and will await the next valid accessing and/or activation of the apparatus 1.

As noted above, if the re-enable or reset command code is not a valid code, the CPU 4 will ignore the received data, will exit the operational program or interrupt service routine, at step 76, and will await the next valid accessing and/or activation of the apparatus 1. In this regard, if an invalid command code should be entered into the transmitter interface 2A, such as by an authorized user or operator who has made a mistaken entry, or who is trying to cancel the accessing and activation of the apparatus 1, or by an unauthorized person attempting to gain unauthorized access

to the apparatus 1, the CPU 4, upon identifying the code as an invalid command code, will ignore the command code transmission, and will exit the operational program or interrupt service routine, at step 76. The CPU 4 will then await the next valid accessing and/or activation of the apparatus 1.

Any subsequent accessing of the apparatus 1 will reset the apparatus 1 thereby preventing the apparatus 1 from being left in a state of "limbo". In this manner, the apparatus 1 serves to prevent an unauthorized accessing and/or an unwanted disabling or re-enabling or resetting of the vehicle ignition system 7 and/or the vehicle fuel pump system 9 along with the activation or the deactivation of any of the various vehicle equipment systems 11 which may be utilized, unless and until all valid codes are utilized.

The above safeguards will also prevent a wrong or mis-dialed number from accidentally accessing and activating the apparatus 1 which may result in an unwanted disabling or re-enabling, or the activation or de-activation, of the respective vehicle systems. These safeguards may be provided at the access code level of transmission and/or at the command code level of transmission. Such safeguards also prevent the apparatus 1 from being accessed and left in a state of "limbo" which may compromise the ability of an authorized user or operator to access and utilize the apparatus 1. It is important to note that the entry of an invalid access code will simply fail to access the apparatus 1.

In this manner, the apparatus 1 serves to prevent an unauthorized or an unwanted disabling or re-enabling or setting or resetting of the vehicle ignition system 7 and/or the vehicle fuel pump system 9 along with the activation or the de-activation of any of the various vehicle equipment systems 11 which may be utilized.

As noted above, with reference to FIG. 6, once a valid disable code has been recognized by the CPU 4, at step 64, the apparatus 1 will, at step 65, activate the vehicle position and locating device 13. The operation of the vehicle position and locating device 13 will then be initiated, at step 65, and will operate simultaneously and/or concurrently with, and independently of, the apparatus 1 and the CPU 4 in the performance of the operational steps 66-76 and 71-76 as described above. In this manner, the vehicle position and locating device 13 is utilized to calculate, determine and transmit vehicle position data in a manner independently of apparatus control over the vehicle ignition system 7, fuel pump system 9, and/or any of the vehicle equipment system (s) 11.

FIG. 7 illustrates the operation, in flow diagram form, of the vehicle position and locating device 13. As noted above, the operation of the vehicle position and locating device 13 commences at step 65 as shown in FIG. 6 and thereafter operates simultaneously and/or concurrently with, and independently of, the operation of the apparatus 1 and the CPU 4. With reference to FIG. 7, the operation of the vehicle position and locating device 13 is initiated at step 200 of FIG. 7. At step 201, the computer 21 of the vehicle position and locating device 13 activates the global positioning device 22, which is any one of the widely known global positioning devices. Once activated, the global positioning device 22 calculates vehicle position data at step 202 by using well known global positioning calculation methods and/or techniques.

Once the vehicle position data has been calculated at step 202, a test is performed at step 203 in order to determine if the geographical position data (i.e., specific vehicle location identified on a map, location on identified roadway, etc.) has been requested. If geographical position or location data has

been requested, the computer 21 will, at step 204, calculate the geographical position or location data of the vehicle in conjunction with the digital and/or digitized map data which is stored in the database 25. The calculated geographical position data of the vehicle will then be transmitted, at step 205, by the transmitter 24, of the vehicle position and locating device 13, to the vehicle position system receiver 14 which is located at the location of the authorized user or operator, or at the authorized office, agency or other entity.

If, at step 203, geographic position data has not been requested, then the position data which is calculated by the global positioning system 22 is transmitted, at step 205, to the vehicle position system receiver 14. In the preferred embodiment, the calculated vehicle position data is transmitted repeatedly for a predefined time interval which time interval is facilitated by utilizing the time delay at step 206.

In the preferred embodiment, the position data is transmitted repeatedly for a time period of five (5) minutes, which time period is monitored by utilizing the time delay function at step 206. Once the pre-defined time delay period has elapsed, the computer 21 will, at step 207, determine whether the vehicle position and location device 13 has been de-activated, such as would occur once the vehicle has been found and/or recovered and/or if the apparatus 1 has been reset. If the vehicle position and location device 13 has not been de-activated, operation of the vehicle position and locating device 13 will return to step 202 and will once again calculate vehicle position data. In this manner, vehicle position and/or location data may be updated. If the vehicle position device 13 has been de-activated, the computer 21 will, at step 208, exit the operational routine or interrupt service routine and will await its next re-activation.

FIG. 8 illustrates the operation, in flow diagram form, of the vehicle position system receiver 14 which, as noted above, is located at the location of the authorized user or operator or at an office, agency or other entity which is authorized to receive the vehicle position and/or location data. The vehicle position system receiver 14 receives the vehicle position data which is transmitted by the vehicle position transmitter 24 of the vehicle position and locating device 13. In the preferred embodiment, the operation of the vehicle position system receiver 14 is activated upon receipt of a valid access code transmitted by the transmitter 3A. In this regard, the above-described access code, which is transmitted by the transmitter 3A, is also received by the receiver 30 of the vehicle position system receiver 14 thereby activating same.

In this regard, the access code is also utilized to activate the vehicle position system receiver 14. The vehicle position system receiver 14 may also be manually and/or in some other way activated by the authorized user or operator or by the authorized agency, office or entity.

Operation of the vehicle position system receiver 14 is initiated at step 250. The computer 31 will, upon receipt of the activate signal, activate the receiver 30, at step 251, which will await transmission of the vehicle position or location data, from the vehicle position and locating device 13. Upon transmission of the vehicle position data from the vehicle position and locating device 13, the receiver 30 will, at step 252, receive the vehicle position data.

The computer 31 will then, at step 253, determine if the received data is geographic position data. If geographic position data is obtained, the computer 31 will, at step 254, store the position data in memory and will, at step 255, display the position data on the display 33. If geographic position data has not been received, the computer 31, at step

256, will generate an inquiry on the display 33 to determine if geographic position data is desired. The system will then await operator response via the user interface 32. If the user selects to receive geographic position data, the computer 31 will proceed to step 257 and calculate geographic position data from the received "raw" position data.

The computer 31 will then, at step 254, store the data for the vehicle position and will, at step 255, display the vehicle position data on the display 33. If, at step 256, the user does not want to obtain geographic position data, the computer 31 will, at step 254, store the "raw" position data and display it on the display 33 in a latitude and/or longitude format, and/or in any other suitable and/or conventional format and/or manner which is utilized in conjunction with the global positioning device 22 or global positioning technology.

At step 258, the computer 31 will determine if more than one vehicle position data point has been stored. If only one vehicle position data point has been stored, the computer 31 will instruct the receiver 30 to receive the next vehicle position data transmission at step 252. If, at step 258, more than one vehicle position data point has been stored, the computer 31 will, at step 259, calculate the track of vehicle movement and display the vehicle movement track on the display 33 at step 260. The computer 31, at step 261, will then determine if the authorized user or operator desires to continue operation of the vehicle position system receiver 14.

If the user or operator desires operation of the vehicle receiver system receiver 14 to continue, such as is the case when the vehicle has not yet been found or recovered, the computer 31 will return to operation, at step 252, and the receiver 30 will receive the next vehicle position data transmission and operation of the vehicle position system receiver 14 will continue. If, however, it is determined, at step 261, that the user or operator desires to discontinue operation of the vehicle position system receiver 14, such as is the case when the vehicle has been found or recovered, the vehicle position system receiver 14 will be de-activated and its operation will cease at step 262. Thereafter, the vehicle position system receiver 14 will await its next activation.

It is important to note that the above described operation of the vehicle position and locating device 13 and the vehicle position system receiver 14 will continue to operate, and continuously update vehicle position data until the vehicle is found and/or recovered, at which point these systems may be de-activated. It is envisioned that the apparatus 1 of the present invention may track and/or locate the vehicle anywhere in the world. It is also important to note that vehicle position data, which is received at the vehicle position system receiver 14, may be output via a printer, via the computer display monitor and/or via a voice synthesized audio output via a speaker (not shown) which is connected to the vehicle position receiver system 14.

In this manner, the apparatus 1 of the present invention may be utilized to find and/or recover a stolen vehicle and/or to monitor vehicle operation and/or vehicle location and/or movement.

In the above described manner, the present invention provides for an apparatus and a method for allowing an authorized user or operator of a vehicle to prevent vehicle theft, to facilitate stolen vehicle recovery, and/or to safely surrender the vehicle under force, or threat of force, while affording the authorized user or operator the opportunity to prevent or seriously thwart the vehicle theft from a safe location or vantage point and facilitate vehicle recovery. The

present invention may also be utilized to thwart, or prevent a vehicle theft even if the vehicle theft was discovered at a later time or from a location remote from the vehicle.

Further, the present invention provides for an apparatus and a method for disabling and/or re-enabling various systems of the vehicle, when the vehicle is not in use, simply by "calling up" the apparatus 1, so as to disable the vehicle and provide added security against theft. In this manner, an authorized user or operator may disable the vehicle ignition system 7, fuel pump system 9 and/or any of a variety of the vehicle equipment systems 11, of a vehicle which may be parked or in use, from any location and/or at any time.

An authorized user or operator may also access the apparatus 1 at any time and, with the use of an appropriate command code, may determine the operating status of the vehicle and/or any one or more of the various vehicle systems so as to determine if, for example, the ignition system 7 or fuel pump system 9 is activated or on, thereby alerting the authorized user or operator that someone is operating the vehicle. An authorized user or operator may also access the apparatus 1 so as to determine vehicle position and/or location and/or the geographic location of the vehicle. In this manner, the authorized user or operator can provide monitoring and/or control over the vehicle and/or any of the vehicle equipment systems and/or devices, determine the status of the vehicle and/or of any of the vehicle equipment systems or devices, and/or determine and/or monitor the location of his or her vehicle at any time and for any reason. In this regard, a safe and an effective anti-theft and/or vehicle recovery apparatus and method is provided by the present invention.

While, in the above description, the operation of the present invention has been described and illustrated in conjunction with the use of a valid disable command code and a valid re-enable or reset command code, it is also envisioned that any number of valid disable command codes and/or any number of valid re-enable or reset command codes may be utilized, wherein each different disable code or re-enable or reset code may selectively disable or re-enable or reset any one or any combination of the vehicle systems, such as the vehicle ignition system 7, the vehicle fuel pump system 9, and/or any one or more of the various vehicle auxiliary equipment systems 11 which may be utilized. In this manner, the authorized user or operator may utilize the present invention to selectively disable, re-enable, de-activate or re-activate any one or more of the vehicle systems, or a combination thereof, at his or her discretion, at any time, wherever he or she may be. It is important to note that the operational program and/or interrupt service routine may be altered, modified and/or supplemented in order to service the multitude of possible command codes which may be utilized in conjunction with the apparatus 1.

As noted above, an authorized user or operator may also utilize command codes for determining status of the apparatus 1, or of the vehicle, or any one or more of the vehicle systems. A command code may also be employed to simply determine vehicle position data. In any of the above cases, however, the operational program or interrupt service routine would have to be modified so as to identify and service each of the possible command codes. The operational program or interrupt service routine would also have to be modified so as to identify each of the possible valid command codes so as to provide for the appropriate CPU 4 and apparatus 1 response thereto.

The apparatus 1, the CPU 4, and/or any of the vehicle systems and/or devices and/or vehicle equipment systems,

and/or the respective interface devices associated therewith or corresponding thereto, may also be programmable by the user or operator via the transmitter 2, and/or at the vehicle in an appropriate manner and by an appropriately secured device, so that certain parameters, such as the timing, and/or the degree of disabling or re-enabling, of the various vehicle systems may be programmed and/or controlled. Any of the above-described systems and/or devices may be programmable for timed enabling and/or disabling, for timed activation, and/or for deferred activation, etc. By utilizing a multitude of command codes, including disable codes and/or re-enable or reset codes, which codes affect different vehicle systems, or combinations thereof, it is possible to selectively control the vehicle systems from a remote location. This feature provides for greater versatility in the utilization of the apparatus 1.

By providing the capability for utilizing different disable codes and/or re-enable or reset codes, the authorized user or operator may utilize the apparatus 1 of the present invention so as to disable or re-enable or reset the vehicle ignition system 7 and the vehicle fuel pump system 9, at any time, so as to disable the vehicle without activating or de-activating any of the vehicle equipment systems 11, and therefore, without drawing attention to the vehicle.

This feature would enable an authorized user or operator to disable, re-enable, or reset the vehicle ignition system 7, the vehicle fuel pump system 9, and/or activate or de-activate any one or more of the various vehicle equipment systems 11, so as to disable the vehicle at any time and from any location. In this manner, the authorized user or operator may disable the vehicle, and/or any of the vehicle systems, daily and/or nightly, while at work, before going to sleep at night, or at any other time, simply by accessing and activating the apparatus 1 by using the transmitter 2 or transceiver which may simply be a touch-tone telephone.

Since the vehicle ignition system 7 is usually off at these times, the disabling, and the subsequent re-enabling of other vehicle systems will occur as described above with regards to FIG. 6. In this manner, the present invention may provide for an effective device by which to "lock-up" a vehicle, at any time, even when the vehicle is in the rightful possession, or under the control, of the vehicle owner and/or authorized operator.

FIG. 9 illustrates an alternate embodiment of the present invention, wherein an arming device 15 and an activation device 16 are utilized in conjunction with the components of the apparatus 1 of FIG. 1. In FIG. 9, the arming device 15 is utilized to arm, activate, or access the apparatus 1 and provides a means by which to access the apparatus 1 separate and apart from the transmitter 2/receiver 3 combination.

The arming device 15 may be a remote transmitter such as those utilized in conjunction with anti-theft devices or systems and/or alarm systems. The arming device 15 may also be a switch, a card reader, including stripe card readers, proximity card readers, turnstile card readers, insertion card readers, key and key insertion devices and readers, magnetic card readers and/or optical cards and/or card readers. The arming device 15 may also be a key switch, a key pad, a keyless activation device with associated key, and/or any other suitable device. The arming device may also be, or include, a voice recognition device(s) or reader(s), voice signature device(s) or reader(s), fingerprint recognition device(s) or reader(s), handprint recognition device(s) or reader(s), hand scanners and/or hand geometry readers. As with any of the above devices and/or components, the

arming device(s) may be directly connected to the CPU 4 or may be linked to the CPU 4 via a wireless communication link or medium.

It is also envisioned that, with a suitable arming device 15, such as a keypad or other device for data input, the authorized user or operator may arm the apparatus 1 with a desired command code. In this manner, a programmable arming device may be utilized wherein apparatus operation, under the command of any of the variety of possible command codes, can be made automatic and/or programmable. It is important to note that an automatic activation may also be performed by an appropriate code being transmitted to the apparatus 1 via the transmitter 2 or transceiver.

The activation device 16 is chosen to correspond with the arming device 15. In this regard, the activation device 16 may be a switch, a key switch, a keypad, a suitable card reader, including stripe card readers, proximity card readers, turnstile card readers, insertion card readers, key and key insertion devices and readers, magnetic card readers, optical card readers, insertion card readers, optical readers as well as a keyless security device. The activation device 16 is connected directly to the CPU 4 as shown in FIG. 9 or it may be connected to the CPU 4 via a wireless communication link or medium.

It is important to note that, in certain circumstances, such as when a keypad, key switch and/or any of the various cards and card readers are employed, the arming device 15 and the activation device 16 may be one and the same device and/or comprise one and the same combination of devices.

The embodiment of FIG. 9 provides a mechanism by which an authorized user or operator may arm, activate, and/or access the apparatus 1. Upon the arming, activation or accessing of the apparatus 1, the CPU 4 will, upon the activation of the vehicle ignition system 7, monitor the activation device 16. After a selected and predetermined time interval, chosen in the preferred embodiment to be ten (10) seconds, has elapsed, if the user or operator of the vehicle has failed to successfully activate the activation device 16, either by activating the switch, by using the associated key, by inputting a predetermined code (i.e. password or pass code) into the keypad, or by utilizing the appropriate card or key or other device corresponding to the utilized card reader or other associated device, the CPU 4 will issue an appropriate disabling and/or command signal to activate the apparatus 1 automatically so as to thereby disable the vehicle as described above and so as to also activate the vehicle position and locating device 13.

The command code may be pre-programmed as a default code and/or may be operator selected and programmed in any manner described above for user or operator entry of such a code. In this regard, if an unauthorized user or operator fails to properly activate the activation device 16, within the predetermined time period, the CPU 4 will recognize such failure as that which results from an unauthorized use or operation of the vehicle.

In the above-described manner, the embodiment of FIG. 9 provides a mechanism by which the apparatus 1, may be activated automatically or self-activated. By utilizing the embodiment of FIG. 9, the authorized user or operator, after arming the apparatus 1, need not perform a transmission of an access code and a command code to the apparatus 1, as a default code, which is previously chosen and/or programmed into the apparatus 1 will provide a command signal to the CPU 4. As noted above, with an appropriate arming device 15, the command code may be user selected and/or programmable.

It is also important to note that the arming device 15/activation device 16 may be utilized to activate the apparatus 1 and/or any one or more of the vehicle systems, including the ignition system 7, the fuel pump system 9, any one or more of the various vehicle equipment systems 11 which are utilized in conjunction with the apparatus 1, and/or the vehicle position and locating device 13. In this regard, the arming device 15 and the activation device 16 provide a mechanism by which to automatically activate the apparatus 1 along with any other anti-theft system utilized in the vehicle which may be controlled by the apparatus 1. The vehicle position and locating device 13 may also be activated by an automatic activation of the apparatus 1.

It is important to note that it is also possible to program the apparatus 1 with a command code so that the apparatus will be programmed to become activated, or de-activated, automatically, such as upon the occurrence, or lack thereof, of a pre-defined event or occurrence and/or at any desired time. If the apparatus 1 has been programmed to become activated automatically, the transmitter 4A of the CPU 4 can transmit data relating to vehicle status, apparatus status, the status of each of the vehicle systems utilized, as well as vehicle position data, to a respective receiver which is utilized by the authorized user or operator and/or at the receiver located at a central security office. In this regard, the present invention provides an apparatus and method by which a vehicle and/or a premises can report a theft situation and/or occurrence by itself. The apparatus can transmit a signal via transmitter 4A, or any other suitable apparatus transmitter, to a user, operator, owner, occupant or authorized office or individual of, and for, a respective vehicle or premises.

The apparatus may also be designed or programmed to notify the user, operator, owner, occupant, authorized central office or individual with, or by, multiple communication devices, methods and/or efforts. The apparatus may be designed or programmed to telephone, telephone at an alternate phone and/or at a business phone, beep or page, send a facsimile (fax) message transmission to, send a voice message transmission to, send an electronic mail message transmission to, and/or send a message to an answering service for, a user, operator, owner, occupant, authorized central office or individual of, and for, the respective vehicle or premises.

In this regard, the apparatus may be designed or programmed to telephone an owner, user, operator, occupant, or other authorized central office individual or other authorized individual, at a primary phone number, at an alternate or forwarding phone number and/or at a business phone number, send a beeper or pager message to the individual or central office and/or send a facsimile, an electronic mail message, a voice mail message and/or an answering service message to, or for, the individual or central office. In this manner, the apparatus may report a theft and/or a malfunction situation to the interested individual(s) by utilizing multiple notification and/or reporting avenues so as to provide and ensure that the interested individual(s) are in fact notified as soon as possible.

The user, operator, owner or occupant of the respective vehicle or premises may also activate the apparatus from the vehicle or premises and transmit a signal to the receiver 955 of the apparatus 950 at the central office and/or to the receiver 2C, if necessary, so as to communicate with individuals at these receiver locations and/or to report an emergency, a breakdown and/or some other occurrence.

In this regard, the apparatus 1, when in the automatic activation mode, or simply when being monitored and/or

during a status check, may transmit data to the appropriate and respective devices. Further, in this regard, the apparatus 1 of the present invention may be utilized to exercise and/or perform control, monitoring and/or security functions, to report and/or to prevent a vehicle theft and/or determine vehicle position and/or location, in instances when the authorized user or operator is unaware of the theft and/or does not have access to the apparatus or vehicle.

The apparatus and method of the present invention may also be programmable for programmed and/or automatic activation, self-activation, programmed and/or automatic operation and/or self-operation. The apparatus and method of the present invention may provide for an immediate, as well as for a deferred, control, monitoring and/or security function, and/or response thereto, so as to provide for the immediate and/or the deferred control, activation, de-activation, programming, monitoring and/or security, etc., of any one or more of the respective vehicle systems, equipment, devices, appliances, etc., which may be utilized in the above described embodiments as well any of the embodiments described hereinbelow.

In yet another alternate embodiment of the present invention, the vehicle position and locating device 13 comprises a plurality of global positioning devices which are strategically located at various points and/or locations in, or on, the vehicle. FIG. 10 illustrates an alternate embodiment of the vehicle position and locating device which is denoted by the reference numeral 130. In FIG. 10, the vehicle position and/or locating device 130 comprises five (5) global positioning devices 22A, 22B, 22C, 22D and 22E with corresponding global positioning receivers 23A, 23B, 23C, 23D and 23E, respectively, associated therewith. The vehicle position and/or locating device 130 also comprises position data transmitter 24 and a digital map database 25.

Each of the global positioning devices 22A-22E is placed at a different point and/or location in, or on, the vehicle. The distances between each of the global positioning devices is recorded and stored in the computer 21. Upon the activation of the global positioning devices 22A-22E and the calculation of each position or location of each device, the position data is transmitted to, or read by, the computer 21, and a determination is made as to whether the initially stored distances between the devices have changed.

Any change in distance between any two or more of the respective global positioning devices 22A-22E would represent that the vehicle, or at least a portion thereof, has been dismantled, at least in part, and possibly to a greater extent, depending upon the resulting disparity in the respective distances. This information may then be transmitted via transmitter 24 to the vehicle position system receiver 14 and the authorized user or operator can be notified of this condition. In this manner, it can be ascertained if a vehicle has been dismantled, "chopped", or stripped, which information may be vital in the recovery process, and in the insurance claims process. The embodiment of FIG. 10 can also be utilized in order to ascertain if the vehicle has been compacted or "boxed." In this manner, the present invention may also be utilized in order to determine if the vehicle has been structurally altered in any manner.

The apparatus and the method of the present invention may also be utilized in conjunction with a central security office or agency, such as a private security service, or by local or regional law enforcement offices or agencies, in order to provide a prompt means by which to report a vehicle theft, provide for a manner in which to disable and/or re-enable a vehicle system, and/or to determine vehicle

position and/or location so as to facilitate the recovery of the vehicle. In such an embodiment, vehicle owners will register their vehicles and any and all necessary information pertaining thereto, including access and command codes, with the central security office.

The present invention may also be utilized so as to provide for a prompt law enforcement theft reporting, response to the theft report and recovery of the vehicle. FIG. 11A illustrates another alternate embodiment of the present invention wherein the apparatus 1 is utilized in conjunction with a central security office or agency, such as a private security service, or by a local or regional law enforcement office or agency. In FIG. 11A, the apparatus 1 is utilized in conjunction with an associated apparatus 950 which, in the preferred embodiment, is located at the central security office.

The apparatus 950 comprises a receiver 955 which may, but need not, be identical to the receiver 3 which is utilized in the apparatus 1. The receiver 955 should be capable of receiving the various codes which can be transmitted by the transmitter 2 or transceiver (i.e. access code(s) and command code(s)) for any one or for any number of vehicles which may be registered with the central security office. The receiver 955 should be capable of receiving the access code(s) and command code(s) for each registered apparatus.

In the embodiment of FIG. 11A, the apparatus 950 also comprises a computer 970, which is connected to the receiver 955. The apparatus 950 also comprises a vehicle position system receiver 960 for receiving position data which is transmitted from the vehicle position and locating device 13. The position data system receiver 960 is also connected to the computer 970. The computer 970 also comprises the requisite memory ROM and RAM devices (not shown). The apparatus 950 also comprises a display device 980, an user interface device 975 and an output device 985 which can be a printer, all of which devices are connected to the computer 970 and are utilized in conjunction therewith.

The apparatus 950 also comprises a transmitter 965 which is connected to the computer 970. The transmitter 965 serves to transmit data to the apparatus 1. The transmitter 965 may also be utilized to transmit data to the transmitter 2, to the vehicle position system receiver 14 and/or to the home and/or personal computer 150, if utilized. Such data which is transmitted from the transmitter 965 may include the various access and command codes and/or other codes, such as those codes for ascertaining the status of the vehicle, the apparatus 1, or any one or more of the vehicle systems which are controlled, monitored, and/or secured or used in conjunction with the apparatus 1.

It is important to note that, in the preferred embodiment, the receiver 955, the vehicle position system receiver 960, and the transmitter 965 are the same types of devices as those utilized in the apparatus of FIG. 1. In this regard, the receivers 955 and 960, and the transmitter 965, are devices for receiving, and transmitting, respectively, radio signals, satellite communication signals, telecommunications signals, optical communication signals and/or other signals and/or those signals, including digital signals, which are utilized in conjunction with personal communication devices and/or personal communication services (PCS) devices. The devices utilized should, however, be of the same type and/or operate compatibly with the corresponding transmitters and receivers of the apparatus 1.

It is envisioned that the authorized user or operator will register his or her vehicle with the apparatus 950 such as by

registering vehicle identification information along with vehicle access and command code data along with any other pertinent information described hereinabove or hereinbelow. Further, the receiver 955 is programmed to receive any and all of the signals transmitted from each one of the respective registered transmitters 2 of the respectively registered vehicles.

The vehicle position system receiver 960 is programmed to receive the vehicle position data which is transmitted by each one of the respectively registered vehicle position and locating devices 13 of each of the respectively registered vehicles.

The apparatus 950 is utilized in conjunction with the apparatus 1 in the following manner. As noted above, the computer 970 is capable of recognizing all of the possible access code(s) and command code(s) which are recognized by the apparatus 1 for a particular vehicle. The apparatus 950 is capable of storing vehicle identification information as well as access code and command code data for a plurality of registered vehicles.

Upon the occurrence of a vehicle theft, or the discovery thereof, the authorized user or operator can access the apparatus 1 in the manner described above. In a first embodiment, the access code is transmitted to and received at, the receiver 3 of apparatus 1 and at the receiver 955 of apparatus 950. Upon receipt of the access code by both the receiver 3 and the receiver 950, both the apparatus 1 and the apparatus 950, respectively, will be accessed.

Applicant hereby incorporates by reference herein the subject matter of U.S. Pat. No. 4,882,579 which teaches a code division multiplexed acknowledge back (ack-back) paging system which includes a central station which transmits a group of message signals to a group of ack-back pagers which are addressed as a group.

The signal received at the receiver 955 is transmitted to, or read from, the computer 970 of the apparatus 950. The computer 970 will then identify the vehicle which is stolen and/or which has been accessed. When the authorized user or operator transmits the command code, the command code is received at the receiver 955 of the apparatus 950 as well as at the receiver 3 of the apparatus 1. In this regard, when the apparatus 1 is processing the command code and performing the functions corresponding thereto, the computer 970 of the apparatus 950 is simultaneously and/or concurrently processing the command code data so that the authorized personnel monitoring the apparatus 950 will be aware of which command code has been transmitted by the authorized user or operator and which operations are being exercised and/or performed, or are to be performed, on the vehicle (i.e., vehicle ignition system and/or fuel pump system disabled, etc.). The authorized personnel monitoring the apparatus 950 will also be aware of which operations and/or systems, equipment, devices and/or appliances, are being controlled, monitored and/or secured. The apparatus 950, in the preferred embodiment, may also be utilized to exercise and/or perform control, monitoring and/or security functions on, or over, the vehicle and/or any of the vehicle systems, equipment, devices and/or appliances.

Upon the transmission of the vehicle position data from the vehicle position and locating device 13, the vehicle position data will be transmitted to, and received by, the vehicle position system receiver 960 of the apparatus 950 as well as by the vehicle position system receiver 14 of the apparatus 1. The computer 970 of the apparatus 950 will process the received vehicle position data simultaneously and/or concurrently with the processing of said position data by the CPU 4 of the apparatus 1.

In this regard, the vehicle position data can be processed by, and at, the apparatus 950. Vehicle position data can then be displayed to authorized personnel at the central security office on the display device 980 or output via the output device 985 which may be a printer. While operation of the apparatus 950 may be automatic, authorized personnel may enter commands so as to provide control over, or operate, the apparatus 950 via the user interface 975, if desired.

In this manner, vehicle location or movement may be displayed, and/or tracked, on the display device 980 or output via the output device 985 at the central security office. In this regard, authorized personnel at the central security office or agency could locate or track the vehicle and alert the proper authorities.

In yet another embodiment, the access code may be only transmitted to, and received by, the receiver 955 of the apparatus 950. The apparatus 1 may then be accessed and controlled via access and command codes which are transmitted by the transmitter 965 of the apparatus 950 which access and command codes are received by the receiver 3 of the respective vehicle. In this embodiment, the authorized personnel may provide control over the apparatus 1 by inputting data and commands into the user interface 975. In this embodiment, the vehicle position data and any data transmitted by the CPU 4 of the apparatus 1, is transmitted to, and received by, the vehicle position receiver system 960 and/or at the vehicle position system receiver 14, respectively.

In yet another embodiment, the access code may be transmitted and received only at the receiver 3 thereby accessing the apparatus 1. The vehicle transmitter 3A then transmits a data signal to the receiver 955 of the apparatus 950 thereby alerting the apparatus 950 that the vehicle has been stolen. Command code data as well as other data may then be transmitted to the apparatus 1 via the transmitter 965 of the apparatus 950. The apparatus 950 may be designed to operate and/or perform any and all of the described functions automatically and without operator intervention. Vehicle position data may then be received by the vehicle position receiver system 960 and/or at the vehicle position system receiver 14, respectively. The vehicle position data may then be processed at the computer 970 of the apparatus 950 and/or at the computer 31 of the vehicle position system receiver 14.

In this manner, the apparatus 950 can serve to provide control over, and monitor the functions of, the apparatus 1 for a vehicle or for a plurality of vehicles, and further, the apparatus 950 provides the means by which to allow a central security office or local or regional law enforcement office or agency to exercise and/or perform control, monitoring and/or security functions over the vehicles which are registered therewith. The apparatus and method of the present invention may also be utilized to monitor the operational status, operation and/or state or status of a one or more of the various vehicle systems, components and/or devices. In the case where the apparatus 1 is automatically activated, as described above, the apparatus 1 can transmit a signal, indicative of vehicle theft and/or an unauthorized use or operation of the vehicle, to the apparatus 950 thereby reporting the unauthorized use or operation, or theft, before the authorized user or operator is able to discover same.

The apparatus 950 may also be utilized so as to verify and monitor apparatus accessing and/or activation by the authorized user or operator. The authorized user or operator may "call" the central security office simply to determine the status and/or the whereabouts or location of his or her

vehicle. It is important to note that both the apparatus 1 and the apparatus 950 can provide the same functions and exercise the same control, monitoring, and/or security functions over the vehicle.

The above-described alternate embodiment, wherein the present invention is utilized in conjunction with a central security office, such as a private security agency, or a local or regional law enforcement office, agency and/or authority, provides for and facilitates a prompt and an immediate reporting of a vehicle theft or unauthorized use, and/or provides for ascertaining the status and/or the location of and/or the monitoring of the vehicle. This embodiment also allows the authorized user or operator to take any of the possible steps by which to report and/or to thwart the vehicle theft and activate a vehicle recovery system. Law enforcement efforts could be greatly assisted and enhanced as information which identifies the vehicle could then be immediately available to the central security office and/or to the local or regional law enforcement authorities. Such an embodiment could also greatly assist in processing insurance claims relating to stolen vehicles.

The apparatus 950 may also be utilized in connection with an on-line service and/or on, or over, the Internet and/or the World Wide Web, or other suitable communication network or medium, in a manner analogous to that described above in connection with the utilization of a home and/or a personal computer 150.

FIG. 11B illustrates yet another alternate embodiment of the present invention wherein the apparatus of FIG. 11A is utilized in conjunction with an on-line service and/or on, or over, the Internet and/or the World Wide Web or other suitable communication network or medium. In FIG. 11B, the home and/or personal computer 150 of FIG. 5A is utilized in place of the transmitter 2 or transceiver and the vehicle position system receiver 14. The apparatus 950 has associated therewith an on-line service and/or an Internet computer system or server 952 with an associated server receiver 953 and transmitter 957 for receiving and transmitting, respectively, any and all data utilized in conjunction with the operation of the server 952, the apparatus 1 and the apparatus 950.

The transmitter 957 transmits any and all appropriate signals to the appropriate and respective devices of the arrangement of FIG. 11B during apparatus operation. In this regard, the server 952 can exercise and/or perform control, monitoring and/or security functions on, or over, the apparatus 1 and the apparatus 950 and also provide for an apparatus which can be utilized, in its entirety, over an on-line service and/or on, or over, the Internet and/or the World Wide Web or other suitable communication network or medium. In FIG. 11B, a Web Site 954 is associated with the server 952.

Any and all data received by the receiver 955 is also received by the server receiver 953. Data which is transmitted by the home and/or personal computer 150, the CPU transmitter 4A, the receiver transmitter 3A and the vehicle position and locating device transmitter 24 are received by the server receiver 953 as well as by the receivers 955 and 960, respectively.

The server 952 will process the data received by the server receiver 953 and perform the same processing functions and/or computing functions as the computer 970, the CPU 4, and/or the computer 150.

The user may transmit data, via the home and/or personal computer 150, directly to the apparatus 1, to the apparatus 950 and/or to the server 952. By using the computer 150 in

conjunction with an appropriate communications medium, the authorized user or operator may access the server 952 via the on-line service and/or via the associated Web site 954, or in any other appropriate manner, so as to provide control over, and/or obtain any and all of the above-described data and/or information regarding, his or her vehicle over the on-line service and/or on, or over, the Internet and/or the World Wide Web or other suitable communication network or medium.

The authorized user or operator may also access and provide control over or exercise and/or perform control, monitoring and/or security functions on, or over, the apparatus 1, the apparatus 950 and/or the server 952 via the on-line service and/or via the Web Site 954. In this regard, the present invention enables an authorized user or operator to provide control over vehicle systems and/or monitor the vehicle system status and/or position and/or movement of the vehicle over an on-line service and/or on, or over, the Internet and/or the World Wide Web or other suitable communication network or medium. It is important to note that the apparatus transmitters, of the transmitter 2, the receiver 3, the CPU 4, and the vehicle position and locating device 13, once the apparatus 1 has been activated, may also transmit data directly to the receiver 953 of the server 952 and/or to the Web Site 954. In this manner, all of the data transmitted by the apparatus 1 and/or by the apparatus 950 can be supplied to the server 952 of the on-line service and/or the Internet and/or the Web Site 954 of the World Wide Web.

Data access and command code data, as well as other data, may also be transmitted by the authorized user or operator, via the respective apparatus transmitters to the receiver 953 of the server 952 and/or to the Web Site 954.

The server 952 can perform complete control, monitoring and/or security functions on, or over, the apparatus 1, the apparatus 950, the vehicle, and/or each of the vehicle systems. The apparatus and method of the present invention may be equipped with software and hardware for providing a systematic check of any and all of the apparatus and vehicle systems, including the status or state of the vehicle equipment systems, equipment, devices and/or appliances and provide data relating thereto to the user or operator and/or to the authorized individual(s) at the above-described central security office. The server transmitter 957 can transmit control signals and/or other data, including information to the authorized user or operator and to the apparatus 1 and/or to the apparatus 950. It is also envisioned that the server 952 and the computer 970 may be combined into a single central computer system.

In the above manner, the apparatus and method of the present invention provides a remote-controlled control, monitoring and/or security system, or vehicle anti-theft and/or vehicle recovery apparatus and method, for use in conjunction with an on-line service and/or on, or over, the Internet and/or the World Wide Web or other suitable communication network or medium. In this manner, the apparatus and method of the present invention also provides for a remote-controlled control, monitoring and/or security system which provides visual, video, graphical, audio and/or audible information to the user. Use over the Internet and/or the World Wide Web and/or other related communication systems and/or mediums and/or over on-line services provides for global coverage, control, monitoring and/or security for the vehicle.

In yet another alternate embodiment, the present invention is utilized in conjunction with a marine vessel or

vehicle. FIG. 12 illustrates an alternate embodiment of the present invention, wherein the apparatus and method is utilized in conjunction with a boat. In FIG. 12, the apparatus is denoted generally by the reference numeral 1200. While the boat described below is a motor-powered boat, it is important to note that any type of boat, including, but not limited to sailboats, may also be utilized in conjunction with the present invention.

In FIG. 12, the components of the apparatus 1200 which are common to the apparatus 1 of FIG. 1 are designated by the same reference numerals. In FIG. 12, the CPU 4 is electrically connected and/or linked to the boat ignition system 1207, which is located externally from the apparatus 1200. The CPU 4 may or may not be connected and/or linked with the boat ignition system 1207 through an ignition system interface 1208 which is also shown in FIG. 12. The CPU 4 may transmit signals to, as well as receive signals from, the boat ignition system 1207. In this manner, the CPU 4 and the boat ignition system 1207, may exchange information between each other. In this manner, the CPU 4, upon receiving an appropriate signal from the receiver 3, and upon the completion of the requisite data processing routine (s), may issue an electrical, an electronic, and/or any other suitable signal, including a digital command signal, to the boat ignition system 1207. This electrical, electronic and/or other suitable signal, or digital command signal, may be one which will disable the boat ignition system 1207 or one which will re-enable or reset the boat ignition system 1207. The CPU 4 may also interrogate the boat ignition system 1207 and/or receive data from the boat ignition system 1207 which is indicative of boat ignition system status (i.e., whether the boat ignition system 1207 is on or off).

In the preferred embodiment, the CPU 4 is also electrically connected and/or linked to the boat fuel pump system 1209 which is also located externally from the apparatus 1. The CPU 4 may or may not be connected and/or linked with the boat fuel pump system 1209 through a fuel pump system interface 1210 which is also shown in FIG. 12. In the case of an electrical or an electronic fuel pump system, the CPU 4 may provide an electrical, an electronic, and/or other suitable signal, including a digital signal, which will disable or re-enable the boat fuel pump system 1209.

In the case of a mechanical fuel pump system, the CPU 4 may provide an electrical, electronic, and/or other suitable signal, including a digital signal, which will disable or re-enable an electrical valve system, which may be used to control the operation of the mechanical fuel pump system. Whichever the case may be, the CPU 4 will be capable of issuing an electrical, electronic and/or other suitable signal, including a digital signal, to disable or to re-enable the boat fuel pump system 1209. The CPU 4 may also interrogate and/or receive data from the boat fuel pump system 1209 which is indicative of boat fuel pump system status (i.e., whether the boat fuel pump system 1209 is on or off). The CPU 4 may also be electrically connected and/or linked to an appropriate device (not shown) for controlling the operation of a boat exhaust system.

The CPU 4, in the preferred embodiment, is also electrically connected and/or linked to at least one or more of a boat equipment system(s) 1211. The boat equipment system (s) 1211 are located externally from the apparatus 1 and may or may not be connected and/or linked to the CPU 4, via a boat equipment system(s) interface device(s) 1212 which may or may not be required for each one of the variety or multitude of the boat equipment systems which may be utilized in conjunction with the apparatus.

The boat equipment system(s) 1211 may include a loud siren or alarm, which may be located in the cabin or

passenger compartment of the boat and, which may produce a loud piercing sound so as to make it unbearable for an intruder to remain inside the boat cabin and/or passenger compartment. The boat equipment system 1211 may also include an external siren or alarm, which may produce a loud piercing sound, which may be utilized to draw attention to the boat. The boat equipment system 1211 may also include a horn, which may blare continuously or intermittently, so as to also draw attention to the boat.

The boat external light system(s), which may include the boat head lights, tail lights or flashers, which may be constantly illuminated or which may blink on and off repeatedly so as to draw attention to the boat, may also be utilized as a boat equipment system 1211. The boat equipment system 1211 may also include a power door or hatch locking system, including electronic and/or electrical dead bolt locking devices, for securing the boat cabin, cockpit or passenger compartment so as to prevent an entry thereunto or an exit therefrom. In addition, the boat equipment system (s) 1211 may include an engine compartment locking device, such as an electrical and/or mechanical locking device, for preventing unauthorized access into the boat engine compartment, so as to prevent any tampering with the apparatus 1 or with other systems and/or components of the boat.

The boat equipment system(s) 1211 may also include any one or more of the widely known boat anti-theft systems and may also include a boat recovery system or device, including a homing and/or a tracking system, each of which system(s) may be activated by the apparatus 1200 of the present invention. The boat equipment system(s) 1211 may also include communication devices, such as two-way radios, radios, televisions, navigational devices and/or equipment, fire extinguishing equipment, pumping devices for pumping water out of the boat, radar devices and equipment, emergency and/or distress signal equipment, sonar devices and/or equipment, and any electrical, electronic and/or otherwise activated appliances and/or equipment which may be utilized on a boat. Appliances may include household appliances such as refrigerators, stoves, air conditioners, ovens, microwave ovens, lighting systems, etc. The boat equipment system(s) 11 may also include systems for detecting failures in any of the above or any other equipment systems and report such failures to the user or operator whether he or she is operating the boat or is not onboard the boat and/or for reporting such failures to a central office.

The boat equipment system(s) 1211 may also include video recording and/or photographing equipment, which may include video recording device(s) and/or a camera(s), such as those utilized in conjunction with personal computers, televisions, digital televisions, interactive televisions, display telephones, video telephones, and/or other communication devices, including personal communication devices, or a still picture camera(s). The video recording device(s) or camera(s) may be digital recording devices or cameras or other suitable devices or cameras, including typical video recording devices or cameras. The video recording device(s) or camera(s), in a preferred embodiment, has associated therewith a transmitter or transmitter/receiver system for transmitting video images recorded by the video recording device(s) or camera(s) to the user or operator and for receiving signals such as, for example, control signals, by which the user or operator may exercise control over the video recording device(s) or camera(s).

The video recording device(s) or camera(s) may be located at any location on the interior of the boat such as, for

example, in the cabin, cockpit, and/or passenger compartment of the boat so that the user or operator, or any other authorized individual, may observe and/or photograph the operator of the boat, or the occupants and/or cargo of the boat. The video recording(s) or camera(s) may also be located on the boat exterior. The video recording device(s) or camera(s) may have wide angles for maximum angular viewing and may also be pivotable and/or movable. The video recording device(s) or camera(s) may record and/or transmit the recorded video and/or the picture(s) in real time and/or live. The video recording device(s) or camera(s) may also be equipped with a storage medium, for storing the recorded video and/or picture(s), and a transmitter or transceiver for transmitting the stored video and/or picture(s) to the user or operator at a later time. In this manner, real-time, as well as deferred, video and/or picture(s) transmissions may be provided.

The boat equipment system(s) 1211 may also include audio recording equipment, which may include audio recording device(s) such as microphones and/or tape recorders, such as those utilized in conjunction with personal computers, televisions, digital televisions, interactive televisions, telephones, cellular telephones, display telephones, video telephones, and/or other communication devices, including personal communication devices. The audio recording device(s) may be digital audio recording devices or other suitable audio devices including typical audio recording devices. The audio recording device(s), in a preferred embodiment, has associated therewith a transceiver or transmitter/receiver system for transmitting the recorded audio to the user or operator and for receiving signals such as, for example, control signals, by which the user or operator may exercise control over the audio recording device(s).

The audio recording device(s) may be located at any location on the interior and/or exterior of the boat so that the user or operator, or any other authorized individual, may hear what is transpiring, and/or what has transpired, inside and/or outside the boat. The audio recording device(s) may also be pivotable and/or movable. The audio recording device(s) may record and/or transmit the recorded audio in real time and/or live. The audio recording device(s) may also be equipped with a storage medium, for storing the recorded audio, and a transmitter or transceiver for transmitting the stored audio at a later time. In this manner, real-time as well as deferred audio transmissions may be provided.

The boat equipment system(s) 1211 may also include an intercom system or device or telephone, cellular, digital or otherwise for providing a means by which to allow the user or operator, or other authorized operator, to communicate with the operator and/or occupants of the boat. The boat equipment system(s) 1211 may also include monitoring device(s) for reading and/or monitoring the boat fuel supply, water and/or coolant supply, electrical generator and/or alternator operation, battery charge level, and/or engine or motor temperature level, marine control system and/or any other boat operation and/or system function. The monitoring device(s), in a preferred embodiment, has associated therewith a transceiver or transmitter/receiver system for transmitting data and/or information recorded and/or read by the monitoring device(s) to the user or operator and for receiving signals such as, for example, control signals, by which the user or operator may exercise control over the monitoring device(s).

As noted above, the use of any one or more of the boat equipment system(s) 1211, and their associated interface devices 1212, may be optional. Further, wireless devices

may be utilized for any of the devices utilized in conjunction with the apparatus 1200.

The boat equipment system(s) 1211 receives signals from the CPU 4, which signals serve to activate or de-activate, or vice versa, whichever the case may be, the respective boat equipment system(s) which are utilized in conjunction with the apparatus 1200. The boat equipment system(s) 1211 may also include any other suitable boat system or equipment feature which may be utilized to draw attention to the boat and/or in some other way to impede boat theft. It should be noted that any of the interface devices 1208, 1210 and 1212 may include any of the requisite interfacing circuitry which may be necessary to facilitate CPU 4 control over the respective systems which may be utilized.

The apparatus 1200 also comprises a position and locating device 13 which can be utilized in order to determine the position and/or the location of the boat. The position and locating device 13 can be utilized so as to determine the position of the boat anywhere in the world and provide for the transmission of boat position and/or location data to any appropriate system receiver so that the boat may be located and/or tracked and recovered. In the preferred embodiment, the position and locating device 13 comprises and utilizes a global positioning device and an associated transmitter for transmitting position and/or location data to the authorized user or operator and/or to an authorized office or agency authorized to receive and/or to monitor such data transmissions.

The apparatus 1200 of FIG. 12 also comprises a position and locating system receiver 14, which may be employed by the authorized user or operator and/or by the authorized office or agency, for receiving and/or processing the data which is transmitted from the position and locating device 13 as described above. The apparatus of may also comprise a user interface device (not shown).

The apparatus and method of the alternate embodiment of FIG. 12 may be utilized and/or operates in the same or in a similar and/or analogous manner as described above with regards to the embodiments of FIGS. 1-11B and/or consistent with the description of the various embodiments and features of the present invention as described herein. The apparatus and method of the present invention may also provide for the immediate, and/or for the deferred, control, activation, deactivation, programming, monitoring and/or security of any one or more of the boat and/or marine vessel or vehicle systems, equipment, devices, appliances, etc., in the same, similar and/or analogous manner as described above with its use in conjunction with vehicles and/or motor vehicles.

Although the present invention has been hereinabove described as being utilized in conjunction with a boat, it is noted that the present invention may be utilized in conjunction with a ship, cruise ship, or any other boat, manned or unmanned, regardless of size, shape or form, private, commercial and/or military. The boat equipment systems may also include guns and/or weapon systems and/or self-defense systems and/or electronic warfare systems. The present invention may also be utilized in conjunction with submersible vehicles such as submarines.

In yet another alternate embodiment, the present invention is utilized in conjunction with an aircraft, airplane, jet or helicopter. FIG. 13 illustrates an alternate embodiment of the present invention, wherein the apparatus and method is utilized in conjunction with an airplane. The apparatus of FIG. 13 is denoted generally by the reference numeral 1300. In FIG. 13, the components of the apparatus which are

common to the apparatus 1 of FIG. 1 are designated by the same reference numerals. In FIG. 13, the CPU 4 is electrically connected and/or linked to the airplane ignition system 1307, which is located externally from the apparatus 1300. The CPU 4 may or may not be connected and/or linked with the airplane ignition system 1307 through an ignition system interface 1308 which is also shown in FIG. 13.

The CPU 4 may transmit signals to, as well as receive signals from, the airplane ignition system 1307. In this manner, the CPU 4 and the airplane ignition system 1307, may exchange information between each other. In this manner, the CPU 4, upon receiving an appropriate signal from the receiver 3, and upon the completion of the requisite data processing routine, may issue an electrical, an electronic, and/or any other suitable signal, including a digital command signal, to the airplane ignition system 1307. This electrical, electronic and/or other suitable signal, or digital command signal, may be one which will disable the airplane ignition system 1307 or one which will re-enable or reset the airplane ignition system 7. The CPU 4 may also interrogate the airplane ignition system 1307 and/or receive data from the airplane ignition system 1307 which is indicative of ignition system status (i.e., whether the airplane ignition system 1307 is on or off).

In the preferred embodiment, the CPU 4 is also electrically connected and/or linked to the airplane fuel pump or supply system 1309 which is also located externally from the apparatus 1300. The CPU 4 may or may not be connected and/or linked with the airplane fuel pump system 1309 through a fuel pump system interface 1310 which is also shown in FIG. 13. In the case of an electrical or an electronic fuel pump system, the CPU 4 may provide an electrical, an electronic, and/or other suitable signal, including a digital signal, which will disable or re-enable the airplane fuel pump or supply system 1309.

In the case of a mechanical fuel pump system, the CPU 4 may provide an electrical, electronic, and/or other suitable signal, including a digital signal, which will disable or re-enable an electrical valve system, which may be used to control the operation of the mechanical fuel pump system. Whichever the case may be, the CPU 4 will be capable of issuing an electrical, electronic and/or other suitable signal, including a digital signal, to disable or to re-enable the airplane fuel pump system 1309. The CPU 4 may also interrogate and/or receive data from the airplane fuel pump or supply system 1309 which is indicative of airplane fuel pump system status (i.e., whether the airplane fuel pump system 1309 is on or off). The CPU 4 may also be electrically connected and/or linked to an appropriate device (not shown) for controlling the operation of a airplane exhaust system.

The CPU 4, in the preferred embodiment, is also electrically connected to at least one or more of an airplane equipment system(s) 1311. The airplane equipment system(s) 1311 are located externally from the apparatus 1300 and may or may not be connected to the CPU 4, via an airplane equipment system(s) interface device(s) 1312 which may or may not be required for each one of the variety or multitude of the airplane equipment systems which may be utilized in conjunction with the apparatus 1300.

The airplane equipment system(s) 1311 may include a loud siren or alarm, which may be located in the cabin, passenger compartment and/or cockpit of the airplane and, which may produce a loud piercing sound so as to make it unbearable for an intruder to remain inside the airplane cabin, passenger compartment and/or cockpit. The airplane

equipment system(s) 1311 may also include an external siren or alarm, which may produce a loud piercing sound, which may be utilized to draw attention to the airplane. The airplane equipment system(s) 1311 may also include a horn, which may blare continuously or intermittently, so as to also draw attention to the airplane.

The airplane external light system(s), which may include the airplane head lights, tail lights or flashers, which may be constantly illuminated or which may blink on and off repeatedly so as to draw attention to the airplane, may also be utilized as a airplane equipment system 1311. The airplane equipment system(s) 1311 may also include a power door or hatch locking system or device, for securing the airplane cabin, passenger compartment and/or cockpit so as to prevent an unauthorized entry thereunto or an exit therefrom. In addition, the airplane equipment system(s) 1311 may include a locking system, such as a mechanical locking system, for preventing an unauthorized access into the airplane engine compartment so as to prevent tampering with the apparatus 1300 or with other systems and/or components of the airplane.

The airplane equipment system(s) 11 may also include any one or more of the widely known airplane anti-theft systems and may also include a airplane recovery system or device, including a homing and/or a tracking system, each of which system(s) may be activated by the apparatus 1300 of the present invention. The airplane equipment system(s) 1311 may also include landing gear, communication devices, such as two-way radios, radios, televisions, navigational devices and/or equipment, fire extinguishing equipment, radar devices and equipment, emergency and/or distress signal equipment, sonar devices and/or equipment, and any electrical, electronic and/or otherwise activated appliances and/or equipment which may be utilized on an airplane. Appliances may include household appliances such as refrigerators, stoves, air conditioners, ovens, microwave ovens, lighting systems, etc. The airplane equipment system (s) 1311 may also include systems for detecting failures in any of the above or any other equipment systems and report such failures to the user or operator whether he or she is operating the airplane or is not onboard the airplane and/or for reporting such failures to a central office.

The airplane equipment system(s) 1311 may also include video recording and/or photographing equipment, which may include video recording device(s) and/or a camera(s), such as those utilized in conjunction with personal computers, televisions, digital televisions, interactive televisions, display telephones, video telephones, and/or other communication devices, including personal communication devices, or a still picture camera(s). The video recording device(s) or camera(s) may be digital recording devices or cameras or other suitable devices or cameras, including typical video recording devices or cameras. The video recording device(s) or camera(s), in a preferred embodiment, has associated therewith a transceiver or transmitter/receiver system for transmitting video images recorded by the video recording device(s) or camera(s) to the user or operator and for receiving signals such as, for example, control signals, by which the user or operator may exercise control over the video recording device(s) or camera(s).

The video recording device(s) or camera(s) may be located at any location on the interior of the airplane such as, for example, in the dashboard, cabin, cockpit, and/or passenger compartment of the airplane so that the user or operator, or any other authorized individual, may observe and/or photograph the operator of the airplane, or the

occupants and/or cargo of the airplane. The video recording (s) or camera(s) may also be located on the airplane exterior. The video recording device(s) or camera(s) may have wide angles for maximum angular viewing and may also be pivotable and/or movable. The video recording device(s) or camera(s) may record and/or transmit the recorded video and/or the picture(s) in real time and/or live. The video recording device(s) or camera(s) may also be equipped with a storage medium, for storing the recorded video and/or picture(s), and a transmitter or transceiver for transmitting the stored video and/or picture(s) to the user or operator at a later time. In this manner, real-time, as well as deferred, video and/or picture(s) transmissions may be provided.

The airplane equipment system(s) 1211 may also include audio recording equipment, which may include audio recording device(s) such as microphones and/or tape recorders, such as those utilized in conjunction with personal computers, televisions, digital televisions, interactive televisions, telephones, cellular telephones, display telephones, video telephones, and/or other communication devices, including personal communication devices. The audio recording device(s) may be digital audio recording devices or other suitable audio devices including typical audio recording devices. The audio recording device(s), in a preferred embodiment, has associated therewith a transceiver or transmitter/receiver system for transmitting the recorded audio to the user or operator and for receiving signals such as, for example, control signals, by which the user or operator may exercise control over the audio recording device(s).

The audio recording device(s) may be located at any location on the interior and/or exterior of the airplane so that the user or operator, or any other authorized individual, may hear what is transpiring, and/or what has transpired, inside and/or outside the airplane. The audio recording device(s) may also be pivotable and/or movable. The audio recording device(s) may record and/or transmit the recorded audio in real time and/or live. The audio recording device(s) may also be equipped with a storage medium, for storing the recorded audio, and a transmitter or transceiver for transmitting the stored audio at a later time. In this manner, real-time as well as deferred audio transmissions may be provided.

The airplane equipment system(s) 1311 may also include an intercom system or device or telephone, cellular, digital, or otherwise for providing a means by which to allow the user or operator, or other authorized operator, to communicate with the operator and/or occupants of the airplane. The airplane equipment system(s) 1311 may also include monitoring device(s) for reading and/or monitoring the airplane fuel supply, water and/or coolant supply, electrical generator and/or alternator operation, battery charge level, and/or engine or motor temperature level, airplane flight control systems and/or any other airplane operation and/or system function. The monitoring device(s), in a preferred embodiment, has associated therewith a transceiver or transmitter/receiver system for transmitting data and/or information recorded and/or read by the monitoring device (s) to the user or operator and for receiving signals such as, for example, control signals, by which the user or operator may exercise control over the monitoring device(s).

As noted above, the use of any one or more of the airplane equipment system(s) 1311, and their associated interface devices 1312, may be optional. Further, as described above, wireless devices may be utilized.

The airplane equipment system(s) 1311 receives signals from the CPU 4, which signals serve to activate or

de-activate, or vice versa, whichever the case may be, the respective airplane equipment system(s) which are utilized in conjunction with the apparatus 1300. The airplane equipment system(s) 1311 may also include any other suitable airplane system or equipment feature which may be utilized to draw attention to the airplane and/or in some other way to impede the airplane theft. It should be noted that any of the interface devices 1308, 1310 and 1312 may include any of the requisite interfacing circuitry which may be necessary to facilitate CPU 4 control over the respective systems which may be utilized.

The apparatus 1300 also comprises a position and locating device 13 which can be utilized in order to determine the position and/or the location of the airplane. The position and locating device 13 can be utilized so as to determine the position of the airplane anywhere in the world and provide for the transmission of airplane position and/or location data to any appropriate system receiver so that the airplane may be located and/or tracked and recovered. In the preferred embodiment, the position and locating device 13 comprises and utilizes a global positioning device and an associated transmitter for transmitting position and/or location data to the authorized user or operator and/or to an authorized office or agency authorized to receive and/or to monitor such data transmissions.

The apparatus 1300 also comprises a position and locating system receiver 14, which may be employed by the authorized user or operator and/or by the authorized office or agency, for receiving and/or processing the data which is transmitted from the position and locating device 13 as will be described above. The apparatus 1 may also comprise a user interface device (not shown).

The apparatus and method of the alternate embodiment of FIG. 13 may be utilized and/or operates in the same or in a similar and/or analogous manner as described above with regards to the embodiments of FIGS. 1-12 and/or consistent with the description of the various embodiments and features of the present invention as described herein.

The apparatus and method of the present invention may also provide for the immediate, and/or for the deferred, control, activation, deactivation, programming, monitoring and/or security of any one or more of the airplane systems, equipment, devices, appliances, etc., in the same, similar and/or analogous manner as described herein.

Although the present invention has been hereinabove described as being utilized in conjunction with an airplane, it is noted that the present invention may be utilized in conjunction with any aircraft, including airplanes, jets, gliders, spacecraft, space shuttles, satellites, manned or unmanned, regardless of size, shape or form, private, commercial and/or military. The airplane equipment systems may also include guns and/or weapon systems and/or self-defense systems and/or electronic warfare systems.

In yet another alternate embodiment, the present invention is utilized in conjunction with a snowmobile, jetski or recreational vehicle. FIG. 14 illustrates an alternate embodiment of the present invention wherein the apparatus is utilized in conjunction with a snowmobile. The apparatus of FIG. 14 is denoted generally by the reference numeral 1400. In FIG. 14, the components of the apparatus 1400 which are common to the apparatus 1 of FIG. 1 are designated by the same reference numerals. In FIG. 14, the CPU 4 is electrically connected and/or linked to the snowmobile ignition system 1407, which is located externally from the apparatus 1. The CPU 4 may or may not be connected and/or linked with the snowmobile ignition system 1407 through an ignition system interface 1408 which is also shown in FIG. 14.

The CPU 4 may transmit signals to, as well as receive signals from, the snowmobile ignition system 1407. In this manner, the CPU 4 and the snowmobile ignition system 1407, may exchange information between each other. In this manner, the CPU 4, upon receiving an appropriate signal from the receiver 3, and upon the completion of the requisite data processing routine, may issue an electrical, an electronic, and/or any other suitable signal, including a digital command signal, to the snowmobile ignition system 1407. This electrical, electronic and/or other suitable signal, or digital command signal, may be one which will disable the snowmobile ignition system 1407 or one which will re-enable or reset the snowmobile ignition system 1407. The CPU 4 may also interrogate the snowmobile ignition system 1407 and/or receive data from the snowmobile ignition system 1407 which is indicative of ignition system status (i.e., whether the snowmobile ignition system 1407 is on or off).

In the preferred embodiment, the CPU 4 is also electrically connected and/or linked to the snowmobile fuel pump or supply system 1409 which is also located externally from the apparatus 1400. The CPU 4 may or may not be connected and/or linked with the snowmobile fuel pump system 1409 through a fuel pump system interface 1410 which is also shown in FIG. 14. In the case of an electrical or an electronic fuel pump system, the CPU 4 may provide an electrical, an electronic, and/or other suitable signal, including a digital signal, which will disable or re-enable the snowmobile fuel pump system 1409.

In the case of a mechanical fuel pump system, the CPU 4 may provide an electrical, electronic, and/or other suitable signal, including a digital signal, which will disable or re-enable an electrical valve system, which may be used to control the operation of the mechanical fuel pump system. Whichever the case may be, the CPU 4 will be capable of issuing an electrical, electronic and/or other suitable signal, including a digital signal, to disable or to re-enable the snowmobile fuel pump system 1409. The CPU 4 may also interrogate and/or receive data from the snowmobile fuel pump system 1409 which is indicative of snowmobile fuel pump system status (i.e., whether the snowmobile fuel pump system 1409 is on or off). The CPU 4 may also be electrically connected and/or linked to an appropriate device (not shown) for controlling the operation of a snowmobile exhaust system.

The CPU 4, in the preferred embodiment, is also electrically connected and/or linked to at least one or more of a snowmobile equipment system or system(s) 1411. The snowmobile equipment system(s) 1411 are located externally from the apparatus 1400 and may or may not be connected to the CPU 4, via a snowmobile equipment system interface 1412 which may or may not be required for each one of the variety or multitude of the snowmobile equipment systems which may be utilized in conjunction with the apparatus.

The snowmobile equipment system(s) 1411 may include a loud siren or alarm, which may be located in, or on, the passenger compartment of the snowmobile and, which may produce a loud piercing sound so as to make it unbearable for an intruder to remain inside or on the snowmobile. The snowmobile equipment system(s) 1411 may also include an external siren or alarm, which may produce a loud piercing sound, which may be utilized to draw attention to the snowmobile. The snowmobile equipment system(s) 1411 may also include a horn, which may blare continuously or intermittently, so as to also draw attention to the snowmobile.

The snowmobile light system(s), which may include the snowmobile head lights, tail lights or flashers, which may be constantly illuminated or which may blink on and off repeatedly so as to draw attention to the snowmobile, may also be utilized as a snowmobile equipment system 1411. The snowmobile equipment system(s) 1411 may also include a power locking systems and/or devices as appropriate as well as steering mechanism locking devices, locking devices for preventing unauthorized access into or onto the snowmobile, snowmobile track locking devices for preventing movement of the snowmobile and/or locking devices for preventing unauthorized access to the snowmobile engine, so as to prevent any tampering with the apparatus or with other systems and/or components of the snowmobile.

The snowmobile equipment system(s) 1411 may also include any one or more of the known snowmobile anti-theft systems and may also include a snowmobile recovery system or device, including a homing and/or a tracking system, each of which system(s) may be activated by the apparatus of the present invention. The snowmobile equipment system (s) 1411 may include any other equipment systems, including any and all of the above-noted equipment systems described herein for use in conjunction with vehicles, boats and airplanes, including video and/or audio recording equipment and/or intercom equipment and/or any of the herein-described communications systems and/or devices.

The snowmobile equipment system(s) 1411 may also include monitoring device(s) for reading and/or monitoring the snowmobile fuel supply, water and/or coolant supply, electrical generator and/or alternator operation, battery charge level, and/or engine or motor temperature level, snowmobile control system and/or any other snowmobile operation and/or system function. The monitoring device(s), in a preferred embodiment, has associated therewith a transceiver or transmitter/receiver system for transmitting data and/or information recorded and/or read by the monitoring device(s) to the user or operator and for receiving signals such as, for example, control signals, by which the user or operator may exercise control over the monitoring device(s).

As noted above, the use of any one or more of the snowmobile equipment system(s) 1411, and their associated interface devices 1412, may be optional. Further, as described above, wireless devices may also be utilized.

The snowmobile equipment system(s) 1411 receives signals from the CPU 4, which signals serve to activate or de-activate, or vice versa, whichever the case may be, the respective snowmobile equipment system(s) which are utilized in conjunction with the apparatus 1400. The snowmobile equipment system(s) 1411 may also include any other suitable snowmobile system or equipment feature which may be utilized to draw attention to the snowmobile and/or in some other way impede the snowmobile theft. It should be noted that any of the interface devices 1408, 1410 and 1412 may include any of the requisite interfacing circuitry which may be necessary to facilitate CPU 4 control over the respective systems which may be utilized.

The apparatus 1400 also comprises a position and locating device 13 which can be utilized in order to determine the position and/or the location of the snowmobile. The position and locating device 13 can be utilized so as to determine the position of the snowmobile anywhere in the world and provide for the transmission of position and/or location data to any appropriate system receiver so that the snowmobile may be located and/or tracked and recovered. In the preferred embodiment, the position and locating device 13

comprises and utilizes a global positioning device and an associated transmitter for transmitting position and/or location data to the authorized user or operator and/or to an authorized office or agency authorized to receive and/or to monitor such data transmissions.

The apparatus 1400 of FIG. 14 also comprises a position and locating system receiver 14, which may be employed by the authorized user or operator and/or by the authorized office or agency, for receiving and/or processing the data which is transmitted from the snowmobile position and locating device 13 as described above. The apparatus 1 may also comprise a user interface device (not shown).

The apparatus and method of the alternate embodiment of FIG. 14 may be utilized and/or operates in the same or in a similar and/or analogous manner as described herein and/or consistent with the description of the various embodiments and features of the present invention.

The apparatus and method of the present invention may also provide for the immediate, and/or for the deferred control, activation, deactivation, programming, monitoring and/or security of any one or more of the snowmobile and/or recreational vehicle systems, equipment, devices, appliances, etc., in the same, similar and/or analogous manner as described above in conjunction with the various embodiments of the present invention.

Although the present invention has been hereinabove described as being utilized in conjunction with a snowmobile, it is noted that the present invention may also be utilized in conjunction with any type of recreational vehicle, including jetskis, scooters, motorcycles, minibikes, go-carts, mopeds, etc, manned or unmanned, regardless of size, shape or form, private, commercial and/or military. The recreational vehicle equipment systems may also include guns and/or weapon systems and/or self-defense systems and/or electronic warfare systems, if desired, and especially when used in law enforcement and/or military applications.

It is important to note that the present invention can be utilized in conjunction with a motor home, a mobile home and/or a camper as the present invention may be utilized to provide control, monitoring and/or security functions pertaining to motor vehicle equipment and home systems, equipment and appliances.

In still another alternate embodiment, the present invention can be utilized in conjunction with a residential premises, residential building and/or a home or a household control system. FIG. 15 illustrates an alternate embodiment of the present invention wherein the apparatus and method is utilized in conjunction with a home control system. The apparatus of FIG. 15 is denoted generally by the reference numeral 1500. It is understood that, while the embodiment of FIG. 15 is illustrated and described in conjunction with a home or a household system, the apparatus 1500 may be utilized in any residential premises and/or any residential building.

In FIG. 15, the components of the apparatus 1500 which are common to the apparatus 1 of FIG. 1 are designated by the same reference numerals. In FIG. 15, the CPU 4 is electrically connected and/or linked to the home and/or household central electrical system 1507, which is located externally from the apparatus 1500. The CPU 4 may or may not be connected and/or linked with the home central electrical system 1507 through a central electrical system interface 1508 which is also shown in FIG. 15.

The CPU 4 may transmit signals to, as well as receive signals from, the home central electrical system 1507. In this manner, the CPU 4 and the home central electrical system

1507, may exchange information between each other. In this manner, the CPU 4, upon receiving an appropriate signal from the receiver 3, and upon the completion of the requisite data processing routine, may issue an electrical, an electronic, and/or any other suitable signal, including a digital command signal, to the home central electrical system 1507. This electrical, electronic and/or other suitable signal, or digital command signal, may be one which will disable the home central electrical system 1507 or one which will re-enable or reset the home central electrical system 1507. The CPU 4 may also interrogate the central electrical system 1507 and/or receive data from the central electrical system 1507 which is indicative of central electrical system status (i.e., whether the central electrical system 1507, or any portion thereof, is on or off).

In the preferred embodiment, the CPU 4 is also electrically connected and/or linked to the home central heating system 1509 which is also located externally from the apparatus 1500. The CPU 4 may or may not be connected and/or linked with the home central heating system 1509 through a central heating system interface 1510 which is also shown in FIG. 15. The CPU 4 is capable of issuing an electrical, electronic and/or other suitable signal, including a digital signal, to disable or to re-enable the home central heating system 1509. The CPU 4 may also interrogate and/or receive data from the home central heating system 1509 which is indicative of home central heating system status (i.e., whether the central heating system 1509, or any portion thereof, is on or off).

In the preferred embodiment, the CPU 4 is also electrically connected and/or linked to the home central air conditioning system 1511 which is also located externally from the apparatus 1500. The CPU 4 may or may not be connected and/or linked with the home central air conditioning system 1511 through a central air conditioning system interface 1512 which is also shown in FIG. 15. The CPU 4 is capable of issuing an electrical, electronic and/or other suitable signal, including a digital signal, to disable or to re-enable the home central air conditioning system 1511. The CPU 4 may also interrogate and/or receive data from the home central air conditioning system 1511 which is indicative of home central air conditioning system status (i.e., whether the central air conditioning system 1511, or any portion thereof, is on or off).

The CPU 4 may also be electrically connected and/or linked to the home water system 1513 which is also located externally from the apparatus 1500. The CPU 4 may or may not be connected and/or linked with the home water system 1513 through a home water system interface 1514 which is also shown in FIG. 15. The home water system interface 1514, in the preferred embodiment, is an electrically controlled water shut-off valve(s) or similar device(s). The CPU 4 is capable of issuing an electrical, electronic and/or other suitable signal, including a digital signal, to disable or to re-enable the home water system 1513. The CPU 4 may also interrogate and/or receive data from the home water system 1513 which is indicative of the state of the home water system 1513 (i.e. whether the home water system 1513, or any portion thereof, is on or off). The home water system 1513 may then be controlled (i.e. turned on or off) and/or adjusted by the user or operator.

The CPU 4 may also be electrically connected and/or linked to the home thermostat or environmental control system 1517 so as to control and/or monitor home interior temperature. The CPU 4 may or may not be connected and/or linked with the home thermostat system 1517 through a home thermostat system interface 1518 which is also

shown in FIG. 15. The CPU 4 is capable of issuing an electrical, electronic and/or other suitable signal, including a digital signal, to disable or to re-enable the home thermostat system 1517. The CPU 4 may also interrogate and/or receive data from the home thermostat system 1517 which is indicative of the state of the home thermostat system 1517 (i.e. home interior temperature and/or whether the temperature of the home interior, or any portion thereof, is too hot, too cold, or acceptable). The home thermostat system 1517 may then be controlled and/or adjusted by the user or operator. In this manner, the home thermostat system 1517 may then be adjusted and/or controlled by the user or operator via the apparatus 1500. The home thermostat system 1517 may be connected and/or linked to the home central heating system 1509 and/or to the home central air conditioning system 1511 so as to activate, de-activate, set and/or control the operation of these systems, as necessary, in order to, and so as to, achieve the desired temperature and/or environmental conditions in the home.

The CPU 4, in the preferred embodiment, is also electrically connected and/or linked to at least one or more of a home equipment system(s) 1515. The home equipment system(s) 1515 are located externally from the apparatus 1500 and may or may not be connected and/or linked to the CPU 4, via a home system equipment system or systems interface 1516 which may or may not be required for each one of the variety or multitude of the home equipment system(s) 1515 which may be utilized in conjunction with the apparatus 1500.

The home equipment system(s) 1515 may include a home anti-theft and/or burglary alarm system, a loud siren or alarm, which may be located in the interior of the home, which may produce a loud piercing sound so as to make it unbearable for an intruder to remain inside the home, an exterior siren or alarm, which may produce a loud piercing sound, which may be utilized to draw attention to the home and exterior lighting system(s) and interior lighting systems, which lighting systems may be turned on or turned off at the user or operator's discretion and which may be controlled to blink on and off to draw attention to the home.

The home equipment system(s) 1515 may also include a electrical and/or electronically controlled locking devices for doors and/or windows, including electrical and/or electronic dead-bolt locking systems and devices, electrical systems for controlling electrical circuits or systems room-by-room, device-by-device, and/or appliance-by-appliance. The home equipment system(s) 1515 may also include devices for controlling any one or more of the electrical circuits, such as circuits controlled by fuses, circuit breakers or equivalent devices. The home equipment system(s) 1515 may also include devices for controlling and/or monitoring hot water heaters, garage door openers, lawn sprinkler systems, electric fences and/or fencing, in-ground or above-ground pool equipment, filters and/or heaters, home central water valve, individual room water valve, home fire detector equipment and home fire extinguishment equipment. Home equipment system(s) 1515 may also include power door and window closing, locking and opening equipment.

The home equipment system(s) 1515 may also include any and all of a wide variety of home appliances such as televisions, telephones, telephone answering machines, alarm systems, VCRs, stoves, ovens, microwave ovens, door bells, individual lights or lamps, blenders, toasters, personal computers, word processors, stereos, radios, and any other home appliance and/or device which is electrically and/or electronically activated and/or controllable.

The home equipment system(s) 1515 may also include video recording and/or photographing equipment, which

may include video recording device(s) and/or a camera(s), such as those utilized in conjunction with personal computers, televisions, digital televisions, interactive televisions, display telephones, video telephones, and/or other communication devices, including personal communication devices, or a still picture camera(s). The video recording device(s) or camera(s) may be digital recording devices or cameras or other suitable devices or cameras, including typical video recording devices or cameras. The video recording device(s) or camera(s), in a preferred embodiment, has associated therewith a transceiver or transmitter/receiver system for transmitting video images recorded by the video recording device(s) or camera(s) to the owner or occupant and for receiving signals such as, for example, control signals, by which the owner or occupant may exercise control over the video recording device(s) or camera(s).

The video recording device(s) or camera(s) may be located at any location on the interior of the home such as, for example, in any room or rooms of the home so that the owner or occupant, or any other authorized individual, may observe and/or photograph any portions and/or rooms in the interior of the home, or the occupants and/or anything which may be located and/or stored in the home. The video recording device(s) or camera(s) may also be located on the exterior of the home so that the owner or occupant, or any other authorized individual, may observe and/or photograph the exterior of the home or residential premises, or portion thereof, or the individuals or objects and/or anything which may be present, located and/or stored on the premises of home and/or residential premises.

The video recording device(s) or camera(s) may have wide angles for maximum angular viewing and may also be pivotable and/or movable. The video recording device(s) or camera(s) may record and/or transmit the recorded video and/or the picture(s) in real time and/or live. The video recording device(s) or camera(s) may also be equipped with a storage medium, for storing the recorded video and/or picture(s), and a transmitter or transceiver for transmitting the stored video and/or picture(s) to the owner or occupant at a later time. In this manner, real-time, as well as deferred, video and/or picture(s) transmissions may be provided.

The home equipment system(s) may also include audio recording equipment, which may include audio recording device(s) such as microphones and/or tape recorders, such as those utilized in conjunction with personal computers, televisions, digital televisions, interactive televisions, telephones, cellular telephones, display telephones, video telephones, and/or other communication devices, including personal communication devices. The audio recording device(s) may be digital audio recording devices or other suitable audio devices including typical audio recording devices. The audio recording device(s), in a preferred embodiment, has associated therewith a transceiver or transmitter/receiver system for transmitting the recorded audio to the owner or occupant and for receiving signals such as, for example, control signals, by which the owner or occupant may exercise control over the audio recording device(s).

The audio recording device(s) may be located at any location on the interior and/or exterior of the home and/or residential premises so that the owner or occupant, or any other authorized individual, may hear what is transpiring, and/or what has transpired, inside and/or outside the home and/or residential premises. The audio recording device(s) may also be pivotable and/or movable. The audio recording device(s) may record and/or transmit the recorded audio in

real time and/or live. The audio recording device(s) may also be equipped with a storage medium, for storing the recorded audio, and a transmitter or transceiver for transmitting the stored audio at a later time. In this manner, real-time as well as deferred audio transmissions may be provided.

The home equipment system(s) 1515 may also include an intercom system or device or a telephone, cellular, digital or otherwise for providing a means by which to allow the user or operator, or other authorized operator, to communicate with the persons present in, or occupants of, the home. The home equipment system(s) 1515 may also include monitoring device(s) for reading and/or monitoring the home fuel supply, water supply, electrical generator and/or alternator operation, water usage, heat and/or air conditioning usage, electricity usage, gas and/or oil or other fuel usage, telephone usage and charges, appliance usage, etc, a home control system and/or any other home operation and/or system function. The monitoring device(s), in a preferred embodiment, may have associated therewith a transceiver or transmitter/receiver system for transmitting data and/or information recorded and/or read by the monitoring device(s) to the user or operator and for receiving signals such as, for example, control signals, by which the user or operator may exercise control over the monitoring device(s).

As noted above, the use of any one or more of the home equipment system(s) 1515 and/or appliances or devices and their associated interface devices 1516, may be optional. The interface devices 1516 may be wireless devices or modules which need not be directly connected to the CPU 4 or to its respective equipment system. In this regard, hard-wired connections are not necessary. In the case of wireless interface devices or modules 1516, corresponding wireless technology and/or systems may be utilized to provide for the wireless control and operation of the respective equipment(s).

In the case of a mobile home, the apparatus 1500 may also comprise a position and locating device 13 which can be utilized in order to determine the position and/or the location of the mobile home. The mobile home position and locating device 13 can be utilized so as to determine the position of the mobile home anywhere in the world and provide for the transmission of position and/or location data to any appropriate system receiver so that the mobile home may be located and/or tracked and recovered. In a preferred embodiment, the mobile home position and locating device 13 comprises and utilizes a global positioning device and an associated transmitter for transmitting position and/or location data to the authorized user, operator and/or authorized individual.

The apparatus 1500 may also comprise a mobile home position and locating system receiver 14, which may be employed by the authorized user, operator and/or authorized individual, for receiving and/or processing the data which is transmitted from the position and locating device 13 as described in the alternate embodiments above. The apparatus 1 may also comprise a user interface device (not shown).

The home equipment system(s) receives signals from the CPU 4, which signals serve to activate or de-activate, or vice versa, whichever the case may be, the respective home equipment system(s) which are utilized in conjunction with the apparatus 1500. The home equipment system(s) 1515 may also include any other suitable home system or equipment feature which may be utilized to draw attention to the home and/or in some other way impede home theft. It should be noted that any of the interface devices may include any of the requisite interfacing circuitry which may be necessary

to facilitate CPU 4 control over the respective systems which may be utilized. It is understood that, while the embodiment of FIG. 15 is illustrated and described in conjunction with a home or a household system, the embodiment may also be utilized in any residential premises and/or any residential building.

The apparatus and method of the alternate embodiment of FIG. 15 may be utilized and/or operates in the same or in a similar and/or analogous manner as described in conjunction with the embodiments described above, and/or consistent with the description of the various embodiments and features of the present invention as described herein, so as to provide control, monitoring and/or security functions for, and over, a home and/or residential premises.

The apparatus and method of FIG. 15 can provide for an immediate, as well as for a deferred, control, activation, de-activation, programming, monitoring and/or security function and/or response thereto of, and for, any one or more of the home and/or residential premises systems, equipment, devices, appliances, etc., in the same, similar and/or analogous manner as described above in conjunction with its utilization in the embodiments described herein.

As described above in conjunction with use of the apparatus and method of the present invention with vehicles, the present invention may, if desired, perform a test in order to determine the state or status of any particular system, equipment, device and/or appliance before exercising and/or performing a given control, monitoring and/or security function. Depending upon the outcome of the test, the apparatus and method of the present invention may execute, alter and/or defer the performance and/or execution of the control, monitoring and/or security function. For example, a command to shut-off a home central electrical system may be deferred until after the operation of a home security system, which security system may be deemed to have priority in performing a monitoring and shut-down procedure for the entire home, has been successfully completed.

In this manner a homeowner or occupant may access a home system at any time and from any location and thereby exercise and/or perform control, monitoring and/or security functions on, or over, any home system, equipment and/or appliance. The owner or occupant may also monitor the status, state or operation of any home system, equipment, device and/or appliance. Lastly, the owner or occupant may perform security related functions or operations on, and over, the home system, equipment, device and/or appliance. As noted above, the present invention may be utilized in conjunction with a telephone, either analog or digital, a touch tone telephone, a cordless telephone and/or a cellular or mobile telephone, a home and/or a personal computer, having associated telecommunication devices or other suitable peripheral device(s) such as a modem and/or a fax/modem, or other personal communication devices, which may operate over an appropriate telecommunications system, and/or other suitable communications systems, including radio signal, optical, satellite and/or other communications systems.

In still another alternate embodiment, the apparatus of the present invention is utilized in conjunction with a commercial building, commercial office and/or commercial premises control system. FIG. 16 illustrates an alternate embodiment of the present invention wherein the apparatus and method is utilized in conjunction with an commercial office and/or premises control system. It is understood that, while the embodiment of FIG. 16 is illustrated and described in conjunction with an commercial office and/or premises

control system, the embodiment may also be utilized in any commercial building and/or any commercial premises and/or any type of building or premises. The apparatus of FIG. 16 is denoted generally by the reference numeral 1600. In FIG. 16, the components of the apparatus which are common to the apparatus of FIG. 1 are designated by the same reference numerals.

In FIG. 16, the CPU 4 is electrically connected and/or linked to the commercial office and/or premises central electrical system 1607, which is located externally from the apparatus 1600. The CPU 4 may or may not be connected and/or linked with the central electrical system 1607 through a central electrical system interface 1608 which is also shown in FIG. 16. The CPU 4 may transmit signals to, as well as receive signals from, the central electrical system 1607. In this manner, the CPU 4 and the central electrical system 1607, may exchange information between each other. In this manner, the CPU 4, upon receiving an appropriate signal from the receiver 3, and upon the completion of the requisite data processing routine, may issue an electrical, an electronic, and/or any other suitable signal, including a digital command signal, to the central electrical system 1607. This electrical, electronic and/or other suitable signal, or digital command signal, may be one which will disable the central electrical system 1607 or one which will re-enable or reset the central electrical system 1607. The CPU 4 may also interrogate the central electrical system 1607 and/or receive data from the central electrical system 1607 which is indicative of central electrical system status (i.e., whether the central electrical system 1607, or any portion thereof, is on or off).

In the preferred embodiment, the CPU 4 is also electrically connected and/or linked to the commercial office and/or premises central heating system 1609 which is also located externally from the apparatus 1600. The CPU 4 may or may not be connected and/or linked with the central heating system 1609 through a central heating system interface 1610 which is also shown in FIG. 16. The CPU 4 is capable of issuing an electrical, electronic and/or other suitable signal, including a digital signal, to disable or to re-enable the central heating system 1609. The CPU 4 may also interrogate and/or receive data from the central heating system 1609 which is indicative of central heating system status (i.e., whether the central heating system 1609, or any portion thereof, is on or off).

In the preferred embodiment, the CPU 4 is also electrically connected and/or linked to the commercial office and/or premises central air conditioning system 1611 which is also located externally from the apparatus 1600. The CPU 4 may or may not be connected and/or linked with the central air conditioning system 1611 through a central air conditioning system interface 1612 which is also shown in FIG. 16. The CPU 4 is capable of issuing an electrical, electronic and/or other suitable signal, including a digital signal, to disable or to re-enable the central air conditioning system 1611. The CPU 4 may also interrogate and/or receive data from the central air conditioning system 1611 which is indicative of central air conditioning system status (i.e., whether the central air conditioning system 1611, or any portion thereof, is on or off).

The CPU 4 may also be electrically connected and/or linked to the commercial office and/or premises water system 1613 which is also located externally from the apparatus 1600. The CPU 4 may or may not be connected and/or linked with the water system 1613 through a commercial office and/or premises water system interface 1614 which is also shown in FIG. 16. The water system interface 1614, in

the preferred embodiment, is an electrically controlled water shut-off valve(s) and/or device(s). The CPU 4 is capable of issuing an electrical, electronic and/or other suitable signal, including a digital signal, to disable or to re-enable the water system 1613. The CPU 4 may also interrogate and/or receive data from the water system 1613 which is indicative of the state of the water system (i.e. whether the water system, or any portion thereof, is on or off). The commercial office and/or premises water system 1613 may then be adjusted and/or controlled (i.e. turned on or off) by the user or operator.

The CPU 4 may also be electrically connected and/or linked to the commercial office and/or premises thermostat system 1617 which is also located externally from the apparatus 1600. The CPU 4 may or may not be connected and/or linked with the thermostat system 1617 through a commercial office and/or premises thermostat system interface 1618 which is also shown in FIG. 16. The CPU 4 is capable of issuing an electrical, electronic and/or other suitable signal, including a digital signal, to disable or to re-enable the thermostat system 1617. The CPU 4 may also interrogate and/or receive data from the thermostat system 1617 which is indicative of the temperature of the commercial office and/or premises interior (i.e., the interior temperature and/or whether interior temperature, or any portion thereof, is too hot, too cold, or acceptable). The thermostat system 1617 may then be adjusted and/or controlled by the user or operator. The thermostat system 1617 may be connected and/or linked to the central heating system 1609 and to the central air conditioning system 1611 so as to activate and/or control the operation of these systems in order to, and so as to, achieve the desired temperature in the commercial office and/or premises.

The CPU 4, in the preferred embodiment, is also electrically connected and/or linked to at least one or more of a commercial office and/or premises equipment system(s) 1615. The commercial office and/or premises equipment system(s) 1615 are located externally from the apparatus 1600 and may or may not be connected and/or linked to the CPU 4, via a commercial office and/or premises system equipment system(s) interface 1616 which may or may not be required for each one of the variety or multitude of the commercial office and/or premises equipment systems which may be utilized in conjunction with the apparatus.

The commercial office and/or premises equipment system (s) 1615 may include a commercial office and/or premises anti-theft and/or burglary alarm system, loud siren or alarm, which may be located in the interior of the home, which may produce a loud piercing sound so as to make it unbearable for an intruder to remain inside the home, an exterior siren or alarm, which may produce a loud piercing sound, which may be utilized to draw attention to the commercial office and/or premises and exterior lighting system(s) and/or the interior lighting system(s), which lighting systems may be turned on or turned off at the user's or operator's discretion and which may be controlled to blink on and off to draw attention to the commercial office and/or premises.

The commercial office and/or premises equipment system (s) 1615 may also include electrical and/or electronically controlled locking devices for doors and/or windows, including electric or electronic dead-bolt locking devices or systems, electrical systems for controlling electrical circuits or systems room-by-room, device-by-device, and/or appliance-by-appliance.

The commercial office and/or premises equipment system (s) 1615 may also include devices for controlling any one or

more of the electrical circuits, such as circuits controlled by fuses, circuit breakers or equivalent devices. The commercial office and/or premises equipment system(s) 1615 may also include devices for controlling and/or monitoring hot water heaters, garage door openers, lawn sprinkler systems, electric fences and/or fencing, in-ground or above-ground pool equipment, fountain equipment, filters and/or heaters, commercial office and/or premises fire detector equipment and commercial office and/or premises fire extinguishment equipment. Commercial office and/or premises equipment system(s) 1615 may also include power door and window closing, locking and opening equipment.

The commercial office and/or premises equipment system (s) 1615 may also include any and all office equipment and/or premises appliances such as televisions, telephones, telephone answering machines, alarm systems, VCRs, stoves, ovens, microwave ovens, door bells, individual lights or lamps, blenders, toasters, computers and associated peripherals, word processors, stereos, radios, manufacturing equipment and any other commercial office and/or premises appliances and/or devices which are electrically and/or electronically activated and/or controllable.

The commercial office and/or premises equipment system (s) 1615 may also include video recording and/or photographing equipment, which may include video recording device(s) and/or a camera(s), such as those utilized in conjunction with personal computers, televisions, digital televisions, interactive televisions, display telephones, video telephones, and/or other communication devices, including personal communication devices, or a still picture camera(s). The video recording device(s) or camera(s) may be digital recording devices or cameras or other suitable devices or cameras, including typical video recording devices or cameras. The video recording device(s) or camera(s), in a preferred embodiment, has associated therewith a transceiver or transmitter/receiver system for transmitting video images recorded by the video recording device(s) or camera (s) to the owner or occupant and for receiving signals such as, for example, control signals, by which the owner or occupant may exercise control over the video recording device(s) or camera(s).

The video recording device(s) or camera(s) may be located at any location on the interior of the commercial office and/or premises such as, for example, in any room or rooms of the commercial office and/or premises so that the owner or occupant, or any other authorized individual, may observe and/or photograph any portions and/or rooms in the interior of the commercial office and/or premises, or the occupants and/or anything which may be located and/or stored in the commercial office and/or premises. The video recording device(s) or camera(s) may also be located on the exterior of the commercial office and/or premises so that the owner or occupant, or any other authorized individual, may observe and/or photograph the exterior of the commercial office and/or premises, or portion thereof, or the individuals or objects and/or anything which may be present, located and/or stored on the premises of commercial office and/or premises.

The video recording device(s) or camera(s) may have wide angles for maximum angular viewing and may also be pivotable and/or movable. The video recording device(s) or camera(s) may record and/or transmit the recorded video and/or the picture(s) in real time and/or live. The video recording device(s) or camera(s) may also be equipped with a storage medium, for storing the recorded video and/or picture(s), and a transmitter or transceiver for transmitting the stored video and/or picture(s) to the owner or occupant

at a later time. In this manner, real-time, as well as deferred, video and/or picture(s) transmissions may be provided.

The commercial office and/or premises equipment system (s) 1615 may also include audio recording equipment, which may include audio recording device(s) such as microphones and/or tape recorders, such as those utilized in conjunction with personal computers, televisions, digital televisions, interactive televisions, telephones, cellular telephones, display telephones, video telephones, and/or other communication devices, including personal communication devices. The audio recording device(s) may be digital audio recording devices or other suitable audio devices including typical audio recording devices. The audio recording device(s), in a preferred embodiment, has associated therewith a transceiver or transmitter/receiver system for transmitting the recorded audio to the owner or occupant and for receiving signals such as, for example, control signals, by which the owner or occupant may exercise control over the audio recording device(s).

The audio recording device(s) may be located at any location on the interior and/or exterior of the commercial office and/or premises so that the owner or occupant, or any other authorized individual, may hear what is transpiring, and/or what has transpired, inside and/or outside the commercial office and/or premises.

The audio recording device(s) may also be pivotable and/or movable. The audio recording device(s) may record and/or transmit the recorded audio in real time and/or live. The audio recording device(s) may also be equipped with a storage medium, for storing the recorded audio, and a transmitter or transceiver for transmitting the stored audio at a later time. In this manner, real-time as well as deferred audio transmissions may be provided.

The commercial office and/or premises equipment system (s) 1615 may also include an intercom system or device or telephone, cellular, digital or otherwise, for providing a means by which to allow the user or operator, or other authorized individual, to communicate with the persons present in the, or occupants of the, commercial office and/or premises.

The commercial office and/or premises equipment system (s) 1615 may also include monitoring device(s) for reading and/or monitoring the commercial office and/or premises fuel supply, water supply, electrical generator and/or alternator operation, water usage, heat and/or air conditioning usage, electricity usage, gas and/or oil or other fuel usage, telephone usage and charges, commercial office and/or premises equipment and/or appliance usage, etc, a commercial office and/or premises control system and/or any other commercial office and/or premises operation and/or system function. The monitoring device(s), in a preferred embodiment, has associated therewith a transceiver or transmitter/receiver system for transmitting data and/or information recorded and/or read by the monitoring device (s) to the user or operator and for receiving signals such as, for example, control signals, by which the user or operator may exercise control, monitoring and/or security over the monitoring device(s).

As noted above, the use of any one or more of the commercial office and/or premises equipment systems and/or appliances or devices 1615 and their associated interface devices 1616, may be optional. The interface devices 1616 may be wireless devices or modules which need not be directly connected to the CPU 4 or to its respective equipment system. In this regard, wired connections are not necessary. In the case of wireless interface devices or

modules 1616, corresponding wireless technology and/or systems must be utilized to provide for the wireless control and operation of the respective equipment(s).

The commercial office and/or premises equipment system or system(s) 1615 receives signals from the CPU 4, which signals serve to activate or de-activate, or vice versa, whichever the case may be, the respective commercial office and/or premises equipment system(s) which are utilized in conjunction with the apparatus 1600. The commercial office and/or premises equipment system(s) 1615 may also include any other suitable commercial office and/or premises system or equipment feature which may be utilized to draw attention to the commercial office and/or premises and/or in some other way impede commercial office and/or premises theft. It should be noted that any of the interface devices may include any of the requisite interfacing circuitry which may be necessary to facilitate CPU 4 control over the respective systems, equipment, devices and/or appliances which may be utilized.

The apparatus and method of the alternate embodiment of FIG. 16 is utilized and operates in the manner described above in conjunction with the vehicle and/or the home embodiments so as to provide for a system for controlling, monitoring and/or providing security functions for and over a commercial office and/or premises. The apparatus and method of the alternate embodiment of FIG. 16 may be utilized and/or operates in the same or in a similar and/or analogous manner consistent with the description of the various embodiments and features of the present invention as described herein so as to provide control, monitoring and/or security functions over and with respect to the commercial office and/or premises with which the apparatus is utilized in conjunction with.

In the case of mobile commercial office and/or premises, the apparatus 1600 may also comprise a commercial office and/or premises position and locating device 13 which can be utilized in order to determine the position and/or the location of the commercial office and/or premises. The position and locating device 13 can be utilized so as to determine the position of the commercial office and/or premises anywhere in the world and provide for the transmission of position and/or location data to any appropriate system receiver so that the commercial office and/or premises may be located and/or tracked and recovered. In the preferred embodiment, the position and locating device 13 comprises and utilizes a global positioning device and an associated transmitter for transmitting position and/or location data to the authorized user, operator, and/or authorized individual.

The apparatus 1600 also comprises a commercial offices and/or premises position and locating system receiver 14, which may be employed by the authorized user, operator, and/or authorized individual, for receiving and/or processing the data which is transmitted from the position and locating device 13 as described above. The apparatus 1 may also comprise a user interface device (not shown).

The apparatus and method of the alternate embodiment of FIG. 16 is utilized and operates in the manner described above in conjunction with the vehicle and/or the home premises embodiments so as to provide for a system for controlling, monitoring and/or providing security functions for, and over, a commercial office and/or premises. The apparatus and method of the alternate embodiment of FIG. 16 may be utilized and/or operates in the same or in a similar and/or analogous manner as described in conjunction with the various embodiments described herein and/or consistent

with the description of the various embodiments and features of the present invention as described herein, so as to provide control, monitoring and/or security functions for, and over, a commercial office and/or premises.

In this manner, an owner, occupant, and/or authorized individual, may access a commercial office and/or premises system at any time and from any location and thereby exercise and/or perform control, monitoring and/or security functions over any commercial office and/or premises system, equipment, device and/or appliance. The owner, occupant, and/or authorized individual, may also monitor the status, state or operation of any commercial office and/or premises system, equipment, device and/or appliance. Lastly, the owner or authorized individual may perform security related functions or operations on and over the commercial office and/or premises system, equipment, device and/or appliance.

The apparatus and method of FIG. 16 can provide for an immediate, as well as for a deferred, control, activation, de-activation, programming, monitoring and/or security functions and/or responses thereto, of, and for, any one or more of the commercial office and/or premises systems, equipment, devices, appliances, etc., in the same, similar and/or analogous manner as described above with in conjunction with the various embodiments.

As described above in conjunction with use of the apparatus and method of the present invention with vehicles and residential premises, the present invention may, if desired, perform a test in order to determine the state or status of any particular system, equipment, device and/or appliance before exercising and/or performing a given control, monitoring and/or security function. Depending upon the outcome of the test, the apparatus and method of the present invention may execute, alter, and/or defer, the performance and/or the execution of the control, monitoring and/or security function. For example, a command to shut-off a central electrical system may be deferred until after the operation of a security system, which security system may be deemed to have priority in performing a monitoring and shut-down procedure for the entire commercial office and/or premises, has been successfully completed.

As noted above, the present invention, in any of the herein described embodiments, as well as modifications, variations and/or alternate embodiments thereof, may be utilized in conjunction with a telephone, including analog and digital telephones, a touch-tone telephone, a cordless telephone and/or a cellular or mobile telephone, a home and/or a personal computer having associated telecommunication devices or other suitable peripheral device(s) such as a modem and/or a fax/modem, or other personal communication devices, which can operate over an appropriate telecommunication system, and/or other suitable communications systems, including radio signal, optical, satellite and/or other communications systems.

The communications system(s) utilized in any of the embodiments described herein may operate anywhere in the electromagnetic and/or the radio spectrum. In this regard, personal communication service (PCS) systems and devices, including stationary, portable and/or hand-held devices, may also be utilized. Digital signal communications devices and/or systems, including digital satellite systems, may also be utilized. Interactive and/or digital televisions, personal communication devices, personal communications services (PCS) devices, telephones, including telephones which utilize analog or digital technology, personal digital assistants, cellular telephones, display telephones, video telephones,

display cellular telephones and electronically equipped watches, beepers, pagers or paging systems, and/or other devices and/or personal effects and/or accessories may also be utilized for interactive use and/or for the display or output applications and/or functions. In this regard, the apparatus and method of the present invention may be utilized on, or over, the Internet and/or the World Wide Web, or other suitable communication network or medium, in order to control, monitor and/or provide security functions on, or for, any of the herein described vehicles, marine vessels or vehicles, aircraft, recreational vehicles, residential premises and/or commercial premises.

It is also envisioned that the apparatus and method of the present invention may find applications in areas other than those described and illustrated above. The present invention may find application in any type of control, monitoring and/or security system or the like, wherein a long-range remote-controlled and/or interactive system may be utilized in order to provide an immediate, or a deferred, response to a control, monitoring and/or security function, or response thereto, and/or to exercise and/or provide control, monitoring or security over desired items and/or devices from a remote location. The present invention may also be utilized to monitor and/or track the whereabouts or location of various objects and/or systems. In this regard, the apparatus and method of the present invention may be utilized so as to monitor the whereabouts and/or location of individuals and to provide for a means by which to communicate with them.

The apparatus and method of the present invention may be utilized in conjunction with appropriate security devices for preventing access by unauthorized individuals. In this regard, the apparatus and method of the present invention may be utilized in conjunction with appropriate security access devices, secured and/or encrypted communication signals, linkups and mediums. Security measures may include utilization and processing of access codes, encrypted codes, personal identification codes and/or data, software-based security measures and/or devices, hardware-based security measures and/or devices, and/or any combination of software-based and hardware-based measures and/or devices. The security measures and/or methods utilized may also include the use of signal scramblers and associated de-scramblers, and/or any one or more of the widely known devices and/or methods for providing a secured communication system and/or link.

The present invention provides for an apparatus and method for exercising and/or performing remote-controlled control, monitoring and/or security functions and/or operations for any type and variety of vehicles, motor vehicles, marine vessels and vehicles, aircraft, recreational vehicles, residential premises and/or commercial premises.

The apparatus and method of the present invention may also be programmable for programmed and/or automatic activation, self-activation, programmed and/or automatic operation and/or self-operation. The apparatus and method of the present invention may provide for an immediate, as well as for a deferred, control, monitoring and/or security function, and/or response thereto, so as to provide for the immediate and/or for the deferred control, activation, de-activation, programming, monitoring and/or security, etc., of any one or more of the respective systems, equipment, devices, appliances, etc., which may be utilized in any of the above described embodiments and/or in any modifications, variations and/or alternate embodiments thereof.

The present invention may also be equipped with, and be utilized with, hardware and software necessary for providing

self-monitoring functions, automatic control and/or responses to occurrences, providing automatic notice of an occurrence and/or a situation to an owner, user and/or authorized individual. In this regard, any and all of the embodiments described above may comprise a monitoring device, a triggering device and/or any other suitable device for detecting an occurrence and/or a situation which may warrant providing notice to an owner, user and/or authorized operator. In this regard, the apparatus may provide a transmission of any appropriate signal from a transmitter and, if desired, from a voice synthesizer to the owner, user and/or authorized individual, or to the location of the individual. The signal utilized could be in the form of a communication transmission, depending upon the communication medium utilized, a telephone call, a voice message, a beeper and/or pager message, an Electronic mail message, a fax transmission, and/or any other mode of communication which may be utilized with any of the apparatuses, devices and/or components described herein.

Any of the above-described embodiments may be utilized in conjunction with a central security office and/or agency for providing use in conjunction with such a central office and/or agency as described hereinabove. In this manner, each and every embodiment of the present invention may be utilized with a central security office and/or agency. The present invention may also provide a means for occupants of the vehicle, motor vehicle, marine vessel, aircraft, recreational vehicle, residential premises and/or commercial premises to contact a central security office and/or agency and/or any other individual having corresponding communication equipment and/or who is authorized and/or equipped to receive such transmissions.

The present invention enables an owner, user and/or authorized individual, to exercise and/or perform convenient control, monitoring and/or security functions, as and/or operations, over any of the above described or similar objects, vehicles, vessels and/or premises, from a remote location. For example, an individual may conveniently provide control over and monitor, the state and/or status of a vehicle parked at a location distant from his present location, and provide control over and monitor, a boat, an airplane, a vacation home which may be located in another locale, and/or to provide control over and monitor, a business office after hours or while absent therefrom.

The present invention, in any of the embodiments described herein, may be designed to be user-friendly. In this regard, the present invention may be menu-driven, and/or its operation may be menu-selected, from audio menus, visual menus, or both audio and visual menus.

While the present invention has been described and illustrated in various preferred and alternate embodiments, such descriptions are merely illustrative of the present invention and are not to be construed to be limitations thereof. In this regard, the present invention encompasses any and all modifications, variations and/or alternate embodiments with the scope of the present invention being limited only by the claims which follow.

What is claimed is:

1. A control apparatus for a vehicle, which comprises:
 - a first control device, wherein said first control device one of generates and transmits a first signal for one of activating, deactivating, enabling, and disabling, one of a vehicle component, a vehicle device, a vehicle system, and a vehicle subsystem, wherein said first control device is located at the vehicle;
 - wherein said first control device is responsive to a second signal, wherein the second signal is one of generated by

- and transmitted from a second control device, wherein the second control device is located at a location which is remote from the vehicle, and further wherein the second control device is responsive to a third signal, wherein the third signal is one of generated by and transmitted from a third control device, therein the third control device is located at a location which is remote from the vehicle and remote from the second control device.
2. The apparatus of claim 1, which further comprises:
 a monitoring device for monitoring at least one of the vehicle, vehicle operational status, vehicle operation, said one of a vehicle component, a vehicle device, a vehicle system, and a vehicle subsystem, a vehicle one of fuel supply, water supply, and coolant supply, one of electrical generator and alternator operation, battery charge level, engine temperature level, one of an electrical circuit and an electrical device, activity inside the vehicle, and activity outside the vehicle.
3. The apparatus of claim 1, which further comprises:
 a positioning device for determining location of the vehicle, wherein said positioning device is located at the vehicle.
4. The apparatus of claim 1, which further comprises:
 one of a camera and a video recording device for obtaining video information at the vehicle.
5. The apparatus of claim 1, wherein said first control device detects at least one of a vehicle use, an unauthorized use of the vehicle, and a theft of the vehicle.
6. The apparatus of claim 1, wherein the third control device is one of a stationary device, a hand-held device, a mobile device, a telephone, a digital telephone, a cordless telephone, a cellular telephone, a wireless telephone, a computer, a personal computer, a personal digital assistant, a television, an interactive television, a digital television, a personal communications device, a personal communications services device, a display telephone, a video telephone, a watch, a beeper, and pager.
7. The apparatus of claim 1, wherein said one of a vehicle component, a vehicle device, a vehicle system, and a vehicle subsystem, is at least one of a vehicle ignition system, a vehicle fuel system, a vehicle exhaust system, a vehicle one of electrical, mechanical, and electro-mechanical, one of system and component, a vehicle light system, a vehicle alarm system, a vehicle anti-theft system, a vehicle recovery system, a vehicle door lock system, a vehicle hood lock system, a horn, a vehicle surveillance system, a video device, a video recording device, an audio device, and an audio recording device.
8. The apparatus of claim 1, wherein the operation of one of said apparatus and said first control device is at least one of programmed, automatically activated, and self-activating.
9. The apparatus of claim 1, wherein the vehicle is one of a motor vehicle, an automobile, a truck, a tractor trailer, a marine vehicle, a marine vessel, a boat, an aircraft, a jet, a plane, construction equipment, farm equipment, a commercial vehicle, a recreational vehicle, a motorcycle, a snowmobile, a motor home, a mobile home, a water submersible vehicle, and an unmanned one of vehicle and equipment.
10. The apparatus of claim 1, which further comprises:
 a device for one of arming and activating apparatus operation, wherein said one of arming and activating device is located at the vehicle.

11. The apparatus of claim 1, which further comprises:
 a voice synthesizing device for generating a voice message indicative of one of operation of the apparatus, status of the apparatus, operation of said first control device, and operation of the vehicle.
12. A control apparatus for a vehicle, which comprises:
 a first control device, wherein said first control device one of generates and transmits a first signal for one of activating, deactivating, enabling, and disabling, one of a vehicle component, a vehicle device, a vehicle system, and a vehicle subsystem, therein said first control device is located at a location remote from the vehicle;
 wherein said first control device is responsive to a second signal, wherein the second signal is one of generated by and transmitted from a second control device, wherein the second control device is located at a location which is remote from said first control device and remote from the vehicle,
 wherein said first signal controls a third control device, wherein the third control device is located at the vehicle, and further wherein the third control device one of generates and transmits a third signal for one of activating, deactivating, enabling, and disabling, said one of a vehicle component, a vehicle device, a vehicle system, and a vehicle subsystem, in response to said first signal.
13. The apparatus of claim 12, wherein said first control device is a server computer.
14. The apparatus of claim 12, wherein said one of a vehicle component, a vehicle device, a vehicle system, and a vehicle subsystem, is at least one of a vehicle ignition system, a vehicle fuel system, a vehicle exhaust system, a vehicle one of electrical, mechanical, and electro-mechanical, one of system and component, a vehicle light system, a vehicle alarm system, a vehicle anti-theft system, a vehicle recovery system, a vehicle door lock system, a vehicle hood lock system, a horn, a vehicle surveillance system, a video device, a video recording device, an audio device, and an audio recording device.
15. The apparatus of claim 12, wherein said apparatus operates over at least one of the Internet and the World Wide Web.
16. A method for control for a vehicle, which comprises:
 transmitting a first signal from a first control device to a second control device, wherein the first control device is located at a location remote from the vehicle and remote from the second control device;
 transmitting a second signal from the second control device to a third control device, wherein the third control device is located at the vehicle, and further wherein the second control device is located at a location remote from the vehicle;
 generating a third signal at the third control device in response to said second signal,
 one of activating, deactivating, enabling, and disabling, one of a vehicle component, a vehicle device, a vehicle system, and a vehicle a subsystem, in response to said third signal.
17. The method of claim 16, further comprising the step of:
 determining an operational status of at least one of the vehicle component, vehicle device, vehicle system, and vehicle subsystem.

77

18. The method of claim 16, further comprising the step of:

obtaining a video image at the vehicle.

19. The method of claim 16, wherein said one of a vehicle component, a vehicle device, a vehicle system, a and vehicle subsystem, is at least one of a vehicle ignition system, a vehicle fuel system, a vehicle exhaust system, a vehicle one of electrical, mechanical, and electro-mechanical, one of system and component, a vehicle light system, a vehicle alarm system, a vehicle anti-theft system, a vehicle recovery system, a vehicle door lock system, a vehicle hood lock system, a horn, a vehicle surveillance system, a video

78

device, a video recording device, an audio device, and an audio recording device.

20. The method of claim 16, wherein the first control device is one of a stationary device, a hand-held device, a mobile device, a telephone, a digital telephone, a cordless telephone, a cellular telephone, a wireless telephone, a computer, a personal computer, a personal digital assistant, a television, an interactive television, a digital television, a personal communications device, a personal communications services device, a display telephone, a video telephone, a watch, a beeper, and a pager.

* * * * *



LETTER OF DOUGLAS BOEHM REGARDING RESPONDENT'S INVENTIONS

-----Original Message-----

From: Boehm, Douglas A. [mailto:daboehm@foleylaw.com]
Sent: Tuesday, June 13, 2000 3:02 PM
To: 'Brian Utley (Iviewit)'
Subject: FW: Contacting Ray Joao

152.1

FYI - BCC:

-----Original Message-----

From: Boehm, Douglas A.
Sent: Tuesday, June 13, 2000 5:01 PM
To: Elliot Bernstein (Iviewit)
Subject: Contacting Ray Joao

Eliot--

After reconsidering what we discussed last Wednesday, I think it would be better for you to contact Ray Joao directly to find out if he is still interested in pursuing some kind of a business arrangement wherein some of the Iviewit technology would be used with the subject matter of some of his patent applications. I would only be guessing at what was discussed between you two in the past, what kind of a business deal you would be willing to consider in the future, and what type of things would be in his patent applications. Of course, I'd be happy to handle the legal side of structuring the deal, once the business side is somewhat more defined.

Ray's telephone number is 516/663-6543
Ray's email address is "rj_benefitme@yahoo.com"

If you don't have the time to call Ray, perhaps you should ask your business people to follow up on this. Otherwise, let me know if you still want me to do it.

Thanks

--Doug

*Douglas A. Boehm
Foley & Lardner
777 East Wisconsin Avenue
Milwaukee, Wisconsin 53202
Tel: (414)297-5718
Fax: (414)297-4900
Email: daboehm@foleylaw.com*

NOTE: The information transmitted in and/or attached to this message is intended only for the person or entity to which it is addressed and may contain confidential and/or privileged material. Any review, retransmission, dissemination, or other use of, or taking any action in reliance upon, this information by persons or entities other than the intended recipient is prohibited. If you received this information in error, please contact the sender and delete the material from any computer.



EXHIBIT K



REMOTE CONTROL PROVISIONAL APPLICATION DOCUMENT OF COMPANY

Attorney Docket No. 5865-4

APPARATUS AND METHOD FOR PLAYING VIDEO FILES ACROSS THE INTERNET

The present invention is directed to an apparatus and a method for an apparatus and method for playing video files across the internet. A preferred embodiment of the invention is described in the following manner.

- Step 1. Record the video using any recording device (video camera, VCR, BETA, film) and save it to any media format (DVD, CD, tape, etc.).
- Step 2. Hook playback device (digital camera, analog camera, tape deck, DVD ROM, etc.) to computer system. *LD :*
- Step 3. Have the playback device initialized through the Web server via a script.
- Step 4. Using any video conference type software program, connect to the third party.
- Step 5. Begin play of the recorded-media directly from the playback device, and share this material across the network.

This process allows any media to be streamed across the Internet without the need for saving the file or compressing the video and allows perfect playback to net users.



EXHIBIT L



RESPONDENT'S COMMERCIALIZATION QUOTE FROM RESPONSE

In 1992, I began filing patent applications for my own inventions. To date, I have been awarded fifteen (15) United States Patents and have numerous other patents pending. I am currently devoting my full-time efforts towards commercializing my various intellectual properties.



EXHIBIT M



SECTION 115 OF THE PATENT ACT

TITLE 35 PART II CHAPTER 11 Sec. 115.

Sec. 115. - Oath of applicant

The applicant shall make oath that he believes himself to be the original and first inventor of the process, machine, manufacture, or composition of matter, or improvement thereof, for which he solicits a patent; and shall state of what country he is a citizen. Such oath may be made before any person within the United States authorized by law to administer oaths, or, when, made in a foreign country, before any diplomatic or consular officer of the United States authorized to administer oaths, or before any officer having an official seal and authorized to administer oaths in the foreign country in which the applicant may be, whose authority is proved by certificate of a diplomatic or consular officer of the United States, or apostille of an official designated by a foreign country which, by treaty or convention, accords like effect to apostilles of designated officials in the United States, and such oath shall be valid if it complies with the laws of the state or country where made. When the application is made as provided in this title by a person other than the inventor, the oath may be so varied in form that it can be made by him. For purposes of this section, a consular officer shall include any United States citizen serving overseas, authorized to perform notarial functions pursuant to section 1750 of the Revised Statutes, as amended (22 U.S.C. 4221)



EXHIBIT N



**TRANSCRIPTION OF SCHIRAJEE WITNESSING RESPONDENT CHANGING
DOCUMENTS**



**TRANSCRIPTION STATING SCHIRAJEE AND ROSARIO MEET
RESPONDENT**



EXHIBIT O



INTELLECTUAL PROPERTY DOCKET OF FOLEY & LARDNER

IVIEWIT.COM PATENT PORTFOLIO

Tab No.	F&L Dkt. No.	MLG Dkt. No.	Country (Type)	Appl. No.	Filing Date	Application Title	Inventor(s)	Assignee	No. Appl. Pgs/Shts	Priority
1	57103/102	5865-1	U.S. (Provisional)	60/125,824	3/24/1999	Apparatus and Method for Producing Enhanced Digital Images	Eliot I. Bernstein	Iviewit Holdings, Inc.	15/4	N/A
2	57103/103	5865-3	U.S. (Provisional)	60/137,297	6/3/1999	Apparatus and Method for Producing Enhanced Video Images	Eliot I. Bernstein	Iviewit Holdings, Inc.	1/0	N/A
3	57103/104	5865-4	U.S. (Provisional)	60/137,921	6/7/1999	Apparatus and Method for Playing Video Files Across the Internet	Eliot I. Bernstein	Iviewit Holdings, Inc.	1/0	N/A
4	57103/105	5865-4.1	U.S. (Provisional)	60/141,440	6/29/1999	Apparatus and Method for Providing and/or Transmitting Video Data and/or Information in a Communication Network	Eliot I. Bernstein	Iviewit Holdings, Inc.	25/2	N/A
5	57103/106	5865-6	U.S. (Provisional)	60/146,726	8/2/1999	Apparatus and Method for Producing Enhanced Digital Images	Eliot I. Bernstein	Iviewit Holdings, Inc.	18/4	N/A
6	57103/107	5865-5	U.S. (Provisional)	60/149,737	8/19/1999	Apparatus and Method for Producing Enhanced Digital Images and/or Digital Video Files	Eliot I. Bernstein	Iviewit Holdings, Inc.	21/4	N/A
7	57103/108	5865-7	U.S. (Provisional)	60/155,404	9/22/1999	Apparatus and Method for Producing Enhanced Video Images and/or Video Files	Eliot I. Bernstein	Iviewit Holdings, Inc.	29/4	N/A
8	57103/109	5865-8	U.S. (Provisional)	60/169,559	12/8/1999	Apparatus and Method for Producing Enhanced Video Images and/or Video Files	Eliot I. Bernstein	Iviewit Holdings, Inc.	47/5	N/A
9	57103/110	5865-10	PCT (International)	PCT/US00/07772	3/23/2000	Apparatus and Method for Producing Enhanced Digital Images	Eliot I. Bernstein	Iviewit Holdings, Inc.	14/4	60/125,824



VIEWIT.COM PATENT PORTFOLIO

Tab No.	F&L Dkt. No.	MLG Dkt. No.	Country (Type)	Appl. No.	Filing Date	Application Title	Inventor(s)	Assignee	No. Appl. Pgs/SHs	Priority
10	57103/111	N/A	PCT (International)	PCT/US00/15408	6/2/2000	System and Method for Streaming an Enhanced Digital Video File	Bernstein, Shirajee		29/3	60/137,297 60/155,404 60/169,559
11	57103/112	N/A	PCT (International)	PCT/US00/15405	6/2/2000	System and Method for Providing an Enhanced Digital Video File	Bernstein, Utley, Rosario		33/3	60/137,297 60/155,404 60/169,559
12	57103/113	N/A	PCT (International)	PCT/US00/15406	6/2/2000	System and Method for Playing a Digital Video File	Bernstein, Shirajee		29/3	60/137,297 60/155,404 60/169,559
13	57103/114	N/A	U.S. (Non-Provisional)	09/587,730	6/5/2000	System and Method for Streaming an Enhanced Digital Video File	Bernstein, Shirajee		29/3	60/137,297 60/155,404 60/169,559 57103/111PCT
14	57103/115	N/A	U.S. (Non-Provisional)	09/587,026	6/5/2000	System and Method for Playing a Digital Video File	Bernstein, Shirajee		29/3	60/137,297 60/155,404 60/169,559 57103/113PCT
15	57103/116	N/A	U.S. (Non-Provisional)	09/587,734	6/5/2000	System and Method for Providing an Enhanced Digital Video File	Bernstein, Utley, Rosario		33/3	60/137,297 60/155,404 60/169,559 57103/112PCT
16	57103/118	N/A	PCT (International)	PCT/US00/15602	6/7/2000	System and Method for Video Playback Over a Network	Bernstein, Friedstein, Utley		24/2	60/137,921 60/141,440
17	57103/119	5865-1	U.S.	09/522,721	3/10/2000	Apparatus and Method for Producing Enhanced Digital Images	Bernstein		15/4	60/125,824



PARTIAL DISCLOSURE OF PATENT APPLICATION NO. 09/522,721

What was given to Raymond Joao to file in 5865-1 & 5865-10

SUMMARY OF THE INVENTION

The present invention provides an apparatus and a method for producing digital images which overcomes the shortcomings of the prior art. The apparatus includes a camera, which can be a conventional print film camera, digital camera and/or digital developing device, which can be any device or collection of devices for developing the image taken by the camera, into an enlarged print film image or a digital image, and an enlarging device, for enlarging the image. A digital camera can also be utilized to obtain the image. If the image is taken with a digital camera, a print image may be obtained from the digital image. The image can then be enlarged. The image may be enlarged without the need for a print set.

The apparatus also includes a computer and associated peripheral devices for performing the various processing routines of the method of the present invention. The apparatus also includes a scanning device, for scanning the print film image or photograph in order to obtain a digital image representation of same.

The print or digital film image, which is obtained by the camera, can be developed by the developing device, and enlarged by the enlarger. The image print may then be scanned by the scanner in order to generate a digital file or other high quality image extension file. A plurality of these digital files can then be stitched together thereby creating a panoramic scene or image.

The computer may be utilized in order to perform touch-up operations on the obtained image or image collection in order to make refinements and/or enhancements thereto. The image can then be converted from a high resolution image compression extension file to a low resolution graphic or video image extension file.

The resulting file may then be processed so that the image represented therein can be displayed and/or posted for display to a host computer or other suitable device.

The above process can be repeated using different photo depths for any of the obtained images, or portions thereof, in order to create areas of higher resolution for closer inspections of these areas at different image depths.

Accordingly, it is an object of the present invention to provide an apparatus and a method for providing enhanced digital images from print or digital images.

It is another object of the present invention to provide an apparatus and a method for producing digital images, from images, which have improved and enhanced resolution.

It is still another object of the present invention to provide an apparatus and a method for producing digital images, from print film images, which are suitable for

display and/or downloading to a digital computer, a television, a telecommunications environment, and/or any other communications environment.

It is still another object of the present invention to provide an apparatus and a method for providing a digital image which is characterized by effective image compression subsequent to a stitching operation, thereby avoiding any dramatic loss in image quality.

It is another object of the present invention to provide an apparatus and a method for providing a digital image which dispenses with the need to compress the image data.

It is yet another object of the present invention to provide an apparatus and a method for producing digital images which are characterized by high definition resolution, and which are suitable for high definition television, Web television and large, full screen, panoramic internet applications, without loss of resolution upon image magnification or reduction.

It is another object of the present invention to provide an apparatus and a method for producing and transmitting digital images in a network environment which dispenses with the need for plug-in software.

It is still another object of the present invention to provide an apparatus and a method for producing digital images which facilitates high speed file transfer in a network environment and/or in a computer environment.

Other objects and advantages of the present invention will be apparent to those skilled in the art upon a review of the Description of the Preferred Embodiment taken in conjunction with the Drawings which follow.

WHAT IS filed by Raymond Joao in 5865-1 & 5865-10

Attorney Docket No. 5865 10

5

APPARATUS AND METHOD FOR PRODUCING ENHANCED DIGITAL IMAGES

FIELD OF THE INVENTION

The present invention is directed to an apparatus and a method for producing enhanced digital images and, in particular, to an apparatus and a method for producing enhanced resolution digital images from a print film image.

10

SUMMARY OF THE INVENTION

The present invention provides an apparatus and a method for producing digital images which overcomes the shortcomings of the prior art. The apparatus includes a camera, which can be a conventional print film camera, a developing device, which can be any device or collection of devices for developing the image taken by the camera, into a print film image, and an enlarging device, for enlarging the print film image. A digital camera can also be utilized to obtain the image. If the image is taken with a digital camera, a print image is obtained from the digital image. The print image can then be enlarged.

The apparatus also includes a computer and associated peripheral devices for performing the various processing routines of the method of the present invention. The apparatus also includes a scanning device, for scanning the print film image or photograph in order to obtain a digital image representation of same.

The print film image, which is obtained by the camera, can be developed by the developing device, and enlarged by the enlarger. The image print can then be scanned by the scanner in order to generate a digital file or other high quality image extension file. A plurality of these digital files can then be stitched together thereby creating a panoramic scene or image.

The computer may be utilized in order to perform touch-up operations on the obtained image or image collection in order to make refinements and/or enhancements thereto. The image

can then be converted from a high resolution image compression extension file to a low resolution graphic or video image extension file.

The resulting file may then be processed so that the image represented therein can be displayed and/or posted for display to a host computer or other suitable device.

The above process can be repeated using different photo depths for any of the obtained images, or portions thereof, in order to create areas of higher resolution for closer inspections of these areas at different image depths.

Accordingly, it is an object of the present invention to provide an apparatus and a method for providing enhanced digital images from print film images.

It is another object of the present invention to provide an apparatus and a method for producing digital images, from print film images, which have improved and enhanced resolution.

It is still another object of the present invention to provide an apparatus and a method for producing digital images, from print film images, which are suitable for display and/or downloading in a digital computer and/or in a telecommunications environment.

It is still another object of the present invention to provide an apparatus and a method for providing a digital image which is characterized by effective image compression subsequent to a stitching operation, thereby avoiding any dramatic loss in image quality.

It is yet another object of the present invention to provide an apparatus and a method for producing digital images which are characterized by high definition resolution, and which are suitable for high definition television, Web television and large, full screen, panoramic internet applications, without loss of resolution upon image magnification or reduction.

It is another object of the present invention to provide an apparatus and a method for producing and transmitting digital images in a network environment which dispenses with the need for plug-in software.

It is still another object of the present invention to provide an apparatus and a method for producing digital images which facilitates high speed file transfer in a network environment and/or in a computer environment.

Other objects and advantages of the present invention will be apparent to those skilled in the art upon a review of the Description of the Preferred Embodiment taken in conjunction with the Drawings which follow.



MR. UTLEY POINTS TO MISSING ITEMS

516.747.0653

3/9/2000

Guidance
2

Ray Joas

Ray, there are major missing items in docket's 1+6:

1. Claims do not reference stitching
2. Process is amended as shown on the diagram
3. The relationship between the enhanced digital image and the zoom and pan function together with controls is not clear
4. The description and claims stop at the production and loading of the image.

5. Object model Brian



EXHIBIT P



FOLEY & LARDNER'S REQUEST FOR RESPONDENT'S RECORDS

JUN. 6. 2000 3:36PM 33RD FLOOR

NO. 920 P. 2/8

FOLEY & LARDNER

ATTORNEYS AT LAW

CHICAGO
DENVER
JACKSONVILLE
LOS ANGELES
MADISON
MILWAUKEE
ORLANDO

FIRSTAR CENTER
777 EAST WISCONSIN AVENUE
MILWAUKEE, WISCONSIN 53202-5597
TELEPHONE (414) 271-2400
FACSIMILE (414) 297-4900

SACRAMENTO
SAN DIEGO
SAN FRANCISCO
TALLAHASSEE
TAMPA
WASHINGTON, D.C.
WEST PALM BEACH

EMAIL ADDRESS
daboehm@foleylaw.com

Via Facsimile

June 6, 2000

WRITER'S DIRECT LINE
(414) 297-5718

Mr. Lewis S. Meltzer
Meltzer, Lippe, Goldstein & Schlissel, P.C.
190 Willis Avenue
Mineola, New York 11501

Re: Transfer of IP files for IVIEWIT.COM

Dear Mr. Meltzer:

As you may recall, I am the patent attorney at Foley & Lardner that is currently handling the Iviewit.com IP matters that were previously handled by Ray Joao of your firm.

I recently received the following correspondence from your firm: (1) the original Assignment recorded in the United States Patent and Trademark Office (USPTO) for your Docket No. 5865-8 (U.S. Provisional Patent Application No. 60/169,559); and (2) the USPTO Filing Receipt (copy attached) for your Docket No. 5865-1 for Application No. 09/522,721. Although I sincerely appreciate your firm's diligence in continuing to forward Iviewit materials to me, this latest correspondence raises some very serious issues with respect to the Iviewit.com IP matters that were supposed to have been transferred to Foley & Lardner.

I was not previously told about this U.S. Non-Provisional Application being filed (item 2 above). It does not appear in any of the correspondence previously sent to Foley & Lardner. This raises the question of exactly what was filed in the U.S. Patent and Trademark Office, since I do not have a copy of any filing papers for this application. Was a U.S. Declaration filed? What specification and claims were filed? Was an Assignment filed for this application? I must have this information in order to take over prosecution of this application.

More importantly, however, this raises the question of whether any other provisional or non-provisional applications have been filed in the United States or any other country. Both the client, Brian Utley, President of Iviewit.com, and myself have previously asked your firm to transfer all of the Iviewit.com Intellectual Property files to me. (See attached letter to you dated April 28, 2000.) When the files that were sent to me were incomplete, I sent an e-mail (copy attached) to Dawn Laffin of your firm, asking her to look for other Iviewit matters. I subsequently requested that Nicole, Ray's former secretary,



JUN. 6. 2000 3:37PM 33RD FLOOR

NO. 920 P. 3/8

FOLEY & LARDNER

Mr. Lewis S. Meltzer
June 6, 2000
Page 2

double-check that there were no other miscellaneous files that were not on the list of applications (also attached). Now I find out that, after three or four separate requests, all of the Iviewit patent matters were not transferred to us.

I formally request that you have your firm's Docket Administration Department review all of Ray Joao's files to ensure that all of the Iviewit.com materials have been transferred to me. Please forward all letters, memorandums, faxes, e-mails, notes, CD's, disks, and other correspondence between Iviewit.com and your firm, and between any third parties and your firm on behalf of Iviewit.com. It is particularly important that I know which patent applications were filed and what correspondence was submitted to the U.S. Patent & Trademark Office before the expiration of a critical date. Otherwise, the client could possibly lose patent rights. Please confirm that the attached "Iviewit.com Patent Portfolio" table, which lists the patent applications filed for Iviewit.com by your firm, is accurate and complete.

I also request that you contact Ray Joao to confirm which applications were filed in what countries and whether or not Ray has any additional Iviewit correspondence or materials that were not transferred to Foley & Lardner.

Furthermore, the client requests that I obtain a written confirmation from both you and Ray that all files, materials, and correspondence have been transferred to Foley & Lardner.

Please confirm receipt of this facsimile and let me know that these matters will be handled promptly and appropriately.

Very truly yours,

Doug Boehm
Douglas A. Boehm

Enclosure(s)

cc: Mr. Brian Utley, Iviewit.com



JUN. 6.2000 3:38PM 33RD FLOOR

NO. 920 P. 7/8

Boehm, Douglas A.

From: Boehm, Douglas A.
Sent: Tuesday, May 09, 2000 5:28 PM
To: 'dlaffin@mlg.com'
Subject: Iviewit.com Files

Dawn --

As I mentioned on the telephone this afternoon, I received your Federal Express package this morning containing the Meltzer, Lippe files for Iviewit.com. The package contained 7 folders corresponding to your docket numbers 5865-1,3,4,4.1,5,6, and 7. However, the file folder for your docket no. 5865-8 is missing. Furthermore, not all of the paperwork for the PCT application (your docket no. 5865-10) was included in the first file 5865-1 (which is the PCT's parent case). Is there a 5865-10 file also?

During our phone conversation, you agreed to review your docket and files for 5865-8, 5865-10, and any other 5865 matters for Iviewit.com tomorrow, and forward these files to me right away.

Thanks for your assistance.

--Doug

*Douglas A. Boehm
Foley & Lardner
777 East Wisconsin Avenue
Milwaukee, Wisconsin 53202
Tel: (414)297-5718
Fax: (414)297-4900
Email: daboehm@foleylaw.com*

NOTE: The information transmitted in and/or attached to this message is intended only for the person or entity to which it is addressed and may contain confidential and/or privileged material. Any review, retransmission, dissemination, or other use of, or taking any action in reliance upon, this information by persons or entities other than the intended recipient is prohibited. If you received this information in error, please contact the sender and delete the material from any computer.



TRANSCRIPTION OF TELECONFERENCE REFERENCING RESPONDENT'S DESTRUCTION OF NOTES AND OTHER PATENT MATERIALS

Simon Bernstein: I just have one question. Does anybody have, or are we allowed to get, the files of Ray Joao?

Boehm: I have them.

Wheeler: Do you have all of the work that he had?

Bernstein: No, not all of it.

Utley: What was purported to be in the files?

Bernstein: And he also claimed to us that he destroyed part of his files.

Boehm: And I have some of his files. I have what was purported to be all of the firms' files.

<Inaudible comment.>

Utley: Well, there's a whole history, then, because I tried to get complete copies of the files originally, and found out later that not only did he not send us all the files, he didn't even mention that there was an extra filing out there that we didn't even know about.

Bernstein: This one that's in question.

Boehm: Yep

Simon Bernstein: You have no notes, no data on...?

Boehm: No, I have the application. I have things that you could get from the US patent office—that I could get from the US patent office. I have very few notes. I do have some scribbled Ray Joao's notes, but I think you gave me those notes.

Utley: I did. I gave you Bill Dick after Bill yourself[] the notes that I had.

Bernstein: And Ray's made disclosures to us that he destroyed the documents to protect us, which I don't know what he was thinking.

2

Simon Bernstein: Destroyed what documents?

Bernstein: Whatever he had in his files. Other patent copies, copies of the drafts as they proceeded...all that he destroyed to protect us from something I asked him to explain, and his reasoning...because I said to him, you know, usually you destroy documents when you are protecting somebody from something illegal or something. Have I done something that would force you to hurt me possibly? He said it was typical, normal, that all lawyers destroy their records.



Simon Bernstein: If that, in fact, is the case—I've never heard of a lawyer you know other than Nixon destroying anything the work is ours. Am I right Chris when we pay for a lawyer and we pay for the work, the work is ours.

Wheeler: The work product is yours. He may maintain copies of his files and everything; or his confidential notes to himself are not necessarily yours. But the work "product" is...

Simon Bernstein: Would you say that anything germane to the issue belongs to him?

Wheeler: Well, I mean if he wrote notes...in sidebars...yeah.

Bernstein: How about revised patents[]. How about copies? Works in progress

Wheeler: But things which would reinforce your patent, obviously, that is germane to the strength of your patent yes, you would be entitled to copies I don't think we disagree.

Bernstein: He's claiming He destroyed all faxes.



EXHIBIT Q



MOTION AND COUNTERCLAIM

IN THE CIRCUIT COURT OF THE
15TH JUDICIAL CIRCUIT IN AND
FOR PALM BEACH COUNTY,
FLORIDA

PROSKAUER ROSE L.L.P.,
a New York limited partnership,

CA 01-04671 AB

Plaintiff,

v.

IVIEWIT.COM, INC., a Delaware
corporation, IVIEWIT HOLDINGS,
INC., a Delaware corporation, and
IVIEWIT TECHNOLOGIES, INC.,
a Delaware corporation.

Defendants.

COPY / ORIGINAL
RECEIVED FOR FILING

JAN 28 2003

DOROTHY H. WILKEN
CLERK OF CIRCUIT COURT
CIRCUIT CIVIL DIVISION

**DEFENDANTS MOTION FOR LEAVE TO AMEND TO ASSERT
COUNTERCLAIM FOR DAMAGES**

Defendants, IVIEWIT.COM, INC., IVIEWIT HOLDINGS,
INC. and IVIEWIT TECHNOLOGIES, INC., by and through their undersigned
counsel, hereby move this Court for Leave to Amend their Answer so as to assert a
counterclaim in this matter pursuant to Rule 1.170(f) of the Florida Rules of Civil
Procedure and as grounds therefore would state as follows:

1. That the Defendants move to amend their answer in this matter so as to
include a counterclaim in this matter, which by its nature appears to be a compulsory
counterclaim to the extent that the issues arise out of the same nexus of events, as

justice requires that the counterclaim be tried at the same time as the complaint and answer so that all pending issues between the parties may be adjudicated in this action.

2. That as a result of fact that additional evidence in support of the Defendants' counterclaims is found in the Plaintiff's own files and records, the Plaintiff will not be prejudiced by the amendment of the Defendants' answer in this matter, nor will this matter be delayed as to the trial of same.

3. Defendants have attached hereto a copy of the proposed counterclaim.

WHEREFORE the Defendants, move this Honorable Court for the entry of an order permitting the Defendants to amend their answer in this matter.

I HEREBY CERTIFY that a true and correct copy of the foregoing has been provided by U.S. Mail and fax transmission this 20th day of January, 2003 to: Christopher W. Prusaski, Esq., Proskauer Rose, LLP, 2255 Glades Road, Suite 340 W, Boca Raton, FL 33431.

SELZ & MUVDI SELZ, P.A.
214 Brazilian Avenue, Suite 220
Palm Beach, FL 33480
Tel: (561) 820-9409
Fax: (561) 833-9715

By: 

STEVEN M. SELZ
FBN: 777420

IN THE CIRCUIT COURT OF THE
15th JUDICIAL CIRCUIT IN AND
FOR PALM BEACH COUNTY,
FLORIDA

PROSKAUER ROSE, LLP, a New York
limited partnership,

CASE NO.: CA 01-04671 AB

Plaintiff,

vs.

IVIEWIT.COM, INC., a Delaware
corporation, IVIEWIT HOLDINGS,
INC., a Delaware corporation and,
IVIEWIT TECHNOLOGIES, INC.,
a Delaware corporation,

Defendants,

COUNTERCLAIM FOR DAMAGES

COME NOW the Counter Plaintiffs, IVIEWIT.COM, INC., IVIEWIT
HOLDINGS, INC., IVIEWIT TECHNOLOGIES, INC. and IVIEWIT LLC,
hereinafter collectively referred to as "IVIEWIT" or Counter Plaintiffs, and hereby
sues Counter Defendant, PROSKAUER ROSE, LLP, hereinafter "PROSKAUER",
a New York limited partnership, and alleges as follows:

GENERAL ALLEGATIONS COMMON TO ALL COUNTS

1. This is an action for damages in a sum greater than \$15,000.00, exclusive

of interest, taxable costs and attorneys fees.

2. Counter Plaintiff, IVIEWIT.COM, INC., is a Delaware corporation, formed by PROSKAUER, which at all times relevant hereto was authorized to conduct and conducted business in Palm Beach County Florida and the State of California.

3. Counter Plaintiff, IVIEWIT HOLDINGS, INC., is a Delaware corporation, formed by PROSKAUER, which at all times relevant hereto was authorized to conduct and conducted business in Palm Beach County Florida and California.

4. Counter Plaintiff, IVIEWIT TECHNOLOGIES, INC., is a Delaware corporation, formed by PROSKAUER, which at all times relevant hereto was authorized to conduct and conducted business in Palm Beach County Florida and the State of California.

5. IVIEWIT LLC, is a Florida limited liability company, formed by PROSKAUER, which, at all times relevant hereto, was authorized to conduct and conducted business in the Palm Beach County Florida and the State of California.

6. Counter Defendant PROSKAUER ROSE, LLP, (hereinafter "PROSKAUER") is a New York limited partnership, operating a law office in Boca Raton, Palm Beach County, Florida.

Boca Raton, Palm Beach County, Florida.

7. BRIAN G. UTLEY, (hereinafter "UTLEY") was at all times relevant hereto a sui juris resident of the State of Florida and who on or about September of 1999 was the president of Counter Plaintiff, IVIEWIT LLC.

8. CHRISTOPHER WHEELER, (hereinafter "WHEELER") is a sui juris individual and resident of Palm Beach County, Florida, who at all times relevant hereto was a partner of PROSKAUER and who provided legal services to the Counter Plaintiffs.

9. KENNETH RUBENSTEIN, (hereinafter "RUBENSTEIN") is a sui juris individual believed to be a resident of the State of New York and who various times relevant hereto was initially misrepresented by WHEELER as a partner of PROSKAUER and later became a partner of PROSKAUER, and who provided legal services to the Counter Plaintiffs both while at Meltzer, Lippie, et al., and PROSKAUER.

10. RAYMOND JOAO, (hereinafter "JOAO") is a sui juris individual believed to be a resident of the State of New York and who at all times relevant hereto was represented to be RUBENSTEIN's associate at PROSKAUER, when in fact JOAO has never been an employee of PROSKAUER but in fact was an employee of Meltzer, Lippie, et al.

11. That beginning on or about November of 1998, the Counter Plaintiff, IVIEWIT, through its agent and principal, Eliot I. Bernstein ("Bernstein"), held discussions with WHEELER with regard to PROSKAUER providing legal services to the company involving specific technologies developed by Bernstein and two others, which technologies allowed for:

i) Zooming of digital images and video without degradation to the quality of the digital image due to what is commonly referred to as "pixilation";

and,

ii) The delivery of digital video using proprietary scaling techniques;

and,

iii) A combination of the image zoom techniques and video scaling techniques described above; and,

iv) The remote control of video cameras through communications networks.

12. That Bernstein engaged the services of PROSKAUER to provide legal services to the company to be formed, including corporate formation and governance for a single entity and to obtain multiple patents and oversee US and foreign filings for such technologies including the provisional filings for the technologies as described in Paragraph 11 above, the "Technology", and such

other activities as were necessary to protect the intellectual property represented by the Technology.

13. That at the time of the engagement of PROSKAUER, Bernstein was advised and otherwise led to believe that WHEELER was the PROSKAUER partner in charge of the account.

14. Upon information and belief, WHEELER, RUBENSTEIN and JOAO upon viewing the technologies developed by Bernstein, and held by IVIEWIT, realized the significance of the technologies, its various applications to communication networks for distributing video data and images and for existing digital processes, including, but not limited to digital cameras, digital video disks (DVD), digital imaging technologies for medical purposes and digital video, and that WHEELER, RUBENSTEIN and JOAO conspired to undertake and in fact undertook a deliberate course of conduct to deprive Bernstein and IVIEWIT of the beneficial use of such technologies for either the use of third parties, who were other clients of PROSKAUER and WHEELER, or for WHEELER, RUBENSTEIN and JOAO's own financial gain, to the detriment and damage of the Counter Plaintiffs.

15. That WHEELER, who was a close personal friend of UTLEY, recommended to Bernstein and other members of the board of directors of

IVIEWIT that the IVIEWIT engage the services of UTLEY to act as President of the Iviewit.com, LLC based on his knowledge and ability as to technology issues.

16. That at the time that WHEELER made the recommendation of UTLEY to the board of directors, that WHEELER knew that UTLEY was in a dispute with his former employer, Diamond Turf Products and the fact that UTLEY had misappropriated certain patents on hydro-mechanical systems to the detriment of Diamond Turf Products.

17. Additionally, WHEELER was fully aware of the fact that UTLEY was not the highly qualified "engineer" that UTLEY represented himself to be, and that in fact UTLEY lacked real engineering expertise or even an engineering degree and that UTLEY had been fired from Diamond Turf Products due to his misappropriation of patents.

18. That despite such knowledge, WHEELER never mentioned such facts concerning UTLEY to any representative of IVIEWIT and in fact undertook to "sell" UTLEY as a highly qualified candidate who would be the ideal person to undertake day to day operations of IVIEWIT and work on the patents, acting as a qualified engineer.

19. Additionally, WHEELER continued to assist UTLEY in perpetrating such fraud on both the Board of Directors of IVIEWIT and to third parties,

including Wachovia Bank, by approving a false resume for UTLEY to be included in seeking approval of a private placement for IVIEWIT.

20. That based on the recommendations of WHEELER, as partner of PROSKAUER, the board of directors agreed to engage the services of UTLEY as president.

21. That almost immediately after UTLEY's employment and almost one year after initially providing of services, WHEELER provided a retainer agreement for the providing of services by PROSKAUER to IVIEWIT LLC, addressed to UTLEY, a true and correct copy of such retainer agreement (the "Retainer") being attached hereto and made a part hereof as Exhibit "A". That the services provided were in fact to be paid out of the royalties recovered from the use of the Technology, which was to be included in patent pools overseen by RUBENSTEIN.

22. That the Retainer by its terms contemplated the providing of corporate and general legal services to IVIEWIT LLC by PROSKAUER and was endorsed by UTLEY on behalf of IVIEWIT LLC, the Board of Directors of IVIEWIT LLC would not have UTLEY authorized to endorse same as it did not include the intellectual property work which PROSKAUER had already undertaken.

23. That prior to the Retainer, PROSKAUER and WHEELER had provided

legal services to IVIEWIT, including services regarding patent procurement and acted to coordinate such services both internally and with outside counsel, including RUBENSTEIN and JOAO, including times when they were misrepresented as PROSKAUER attorneys.

24. That PROSKAUER billed IVIEWIT for legal services related to corporate, patent, trademark and other work in a sum of approximately \$800,000.00.

25. That PROSKAUER billed IVIEWIT for legal service never performed, double-billed by the use of multiple counsel on the same issue, and systematically overcharged for services provided.

26. That summaries of the billing statements provided by PROSKAUER to IVIEWIT are attached hereto and made a part hereof as Exhibit "B".

27. That based on the over-billing by PROSKAUER, IVIEWIT paid a sum in of approximately \$500,000.00 plus together with a 2.5% interest in IVIEWIT, which sums and interest in IVIEWIT was received and accepted by PROSKAUER.

28. That WHEELER, UTLEY, RUBENSTEIN, JOAO and PROSKAUER, conspired to deprive IVIEWIT of its rights to the technologies developed by Bernstein by:

a) Transferring patents using Foley & Lardner so as to name UTLEY as the sole holder of multiple patents in his individual name and capacity when in fact they were and arose from the technologies developed by Bernstein and others and held by IVIEWIT prior to UTLEY's employment with IVIEWIT, and;

b) Upon discovery of the "lapses" by JOAO, that WHEELER and PROSKAUER referred the patent matters to WILLIAM DICK, of Foley & Lardner, who was also a close personal friend of UTLEY and who had been involved in the diversion of patents to UTLEY at Diamond Turf Products; and,

c) Failing to list proper inventors of the technologies based on improper legal advise that foreign inventors could not be listed until their immigration status was adjusted, resulting in the failure of the patents to include their rightful and lawful inventors and the payment by IVIEWIT for unnecessary immigration work; and,

d) Failing to ensure that the patent applications for the technologies, contained all necessary and pertinent information relevant to the technologies and as required by law; and,

e) Failing to secure trademarks and copyrights and failing to complete trademark and copyright work for the use of proprietary names of IVIEWIT and source code for the Technologies of IVIEWIT as intellectual property, and;

f) Allowing the infringement of patent rights of IVEIWIT and the intellectual property of IVIEWIT by other clients of PROSKAUER and WHEELER, and;

g) Aiding JOAO in filing patents for IVIEWIT intellectual property by intentionally withholding pertinent information from such patents and not filing same timely, so as to allow JOAO to apply for similar patents in his own name, both while acting as counsel for IVIEWIT and subsequently.

29. As a direct and proximate result of the actions of the Counter Defendant, Counter Plaintiffs have been damaged in a sum estimated to be greater than \$10,000,000,000.00, based on projections by Gerald Stanley, CEO of Real 3-D (a consortium of Lockheed, Silicone Graphics and Intel) as to the value of the technologies and their applications to current and future uses together with the loss of funding from Crossbow Ventures as a result of such conduct.

30. All conditions precedent to the bringing of this action have occurred or have been waived or excused.

COUNT I- LEGAL MALPRACTICE

31. This is an action for legal malpractice within the jurisdiction of this court.

32. Counter Plaintiff re-alleges and hereby incorporates that allegations of Paragraphs 1 through 30 as if fully set forth herein.

33. PROSKAUER employed by IVIEWIT for purposes of representing IVIEWIT to obtain multiple patents and oversee foreign filings for such technologies including the provisional filings for the technologies as described in Paragraph 11 above.

34. That pursuant to such employment, PROSKAUER owed a duty to ensure that the rights and interests of IVIEWIT were protected.

35. WHEELER, RUBENSTEIN, JOAO and PROSKAUER neglected that reasonable duty of care in the performance of legal services in that they:

a) Failed to take reasonable steps to ensure that the intellectual property of IVIEWIT was protected; and,

b) Failed to complete work regarding copyrights and trademarks; and,

c) Engaged in unnecessary and duplicate corporate and other work resulting in billing for unnecessary legal services believed to be in excess of \$400,000.00; and,

d) By redacting information from the billing statements regarding services provided so to as to give the appearance that the services provided by PROSKAUER were limited in nature, when in fact they involved various aspects of intellectual property protection; and,

e) By knowingly representing and agreeing to accept representation of

clients in conflict with the interests of IVIEWIT, without either consent or waiver by IVIEWIT.

36. That the negligent actions of PROSKAUER and its partners, WHEELER and RUBENSTEIN, resulted in and was the proximate cause of loss to IVIEWIT.

WHEREFORE, Counter Plaintiff demands judgement for damages against Defendant together with reasonable attorneys fees, court costs, interest and such other and further relief as this Court deems just and equitable.

COUNT II- CIVIL CONSPIRACY

37. This is an action for civil conspiracy within the jurisdiction of this court.

38. Counter Plaintiff re-alleges and hereby incorporates that allegations of Paragraphs 1 through 30 as if fully set forth herein.

39. Defendant, PROSKAUER and UTLEY, WHEELER, RUBENSTEIN and JOAO, jointly conspired to deprive the Counter Plaintiffs of their rights and interest in the Technology.

40. That UTLEY, WHEELER, RUBENSTEIN, JOAO and PROSKAUER with such intent, directed that certain patent rights be put in the name of UTLEY and/or that such patent rights were modified or negligently pursued so as to fail to provide protection of the intellectual property, resulting in the ability of other clients of WHEELER, RUBENSTEIN, JOAO and PROSKAUER to make use of such

technologies without being liable to IVIEWIT for royalties normally arising from such use.

41. That PROSKAUER, without either consent of the Board of Directors or proper documentation, transferred securities to Tiedemann/Prolow Investment Group, which entity was also referred by WHEELER, who acted as counsel for such unauthorized transaction.

42. That upon the discovery of the above-described events and conspiracy, IVIEWIT's lead investor, Crossbow Ventures, ceased its funding of IVIEWIT.

43. That Crossbow Ventures, which was a referral of WHEELER, took a security interest in the Technology under the guise of protecting IVIEWIT and its shareholders from the actions of UTLEY, based on the filing of an involuntary bankruptcy (which was later withdrawn), and as to WHEELER and PROSKAUER based on the instant law suit, when in fact such conduct was motivated by Crossbow's attempts to wrongfully detain the interests of IVIEWIT in the Technology. Such conduct, upon information and belief, was undertaken with the knowledge and assistance of WHEELER and PROSKAUER.

44. As a direct and proximate result of the conspiracy and acts of PROSKAUER, UTLEY, WHEELER, JOAO and RUBENSTEIN, the Counter Plaintiffs have been damaged.

WHEREFORE, Counter Plaintiffs demand judgement for damages against Defendant together with court costs, interest and such other and further relief as this Court deems just and equitable.

COUNT III- BREACH OF CONTRACT

45. This is an action for breach of contract within the jurisdiction of this Court.

46. Counter Plaintiff re-alleges and hereby incorporates that allegations of Paragraphs 1 through 30 as if fully set forth herein.

47. Defendant, PROSKAUER, breached the contract with Counter Plaintiff, IVIEWIT LLC by failing to provide services billed for pursuant to the billing statements presented to the Counter Plaintiffs and over-billing for services provided.

48. That such actions on the part of PROSKAUER constitute beaches of the contract by and between IVIEWIT LLC and PROSKAUER.

49. That as a direct and proximate result of such conduct on the part of PROSKAUER, IVIEWIT LLC has been damaged by overpayment to PROSKAUER and the failure of PROSKAUER to perform the contracted for legal services.

WHEREFORE, IVIEWIT demands judgement for damages against Counter Defendant together with court costs, interest and such other and further relief as this Court deems just and equitable.

**COUNT IV- TORTIOUS INTERFERENCE WITH AN ADVANTAGEOUS
BUSINESS RELATIONSHIP**

50. This is an action for tortious interference with an advantageous business relationship within the jurisdiction of this Court.

51. Counter Plaintiff re-alleges and hereby incorporates that allegations of Paragraphs 1 through 30 as if fully set forth herein.

52. Counter Plaintiff was engaged in negotiations of technology agreements with both Warner Bros. and AOL/Time Warner as to the possible use of the Technologies of the Counter Plaintiffs and investment in Counter Plaintiffs as a strategic partner.

53. That despite the prior representations of RUBENSTEIN, at a meeting held on or about November 1, 2000, by and between UTLEY, RUBENSTEIN and representatives of Warner Bros. as to the Technology of IVIEWIT and the efficacy, novelty and unique methodology of the Technology, RUBENSTEIN refused to subsequently make the same statements to representatives of AOL and Warner Bros., taking the position that since Warner Bros./AOL is "now a big client of Proskauer, I can't comment on the technologies of Iviewit." or words to that effect in response to inquiry from Warner Brother/AOL's counsel as to the status and condition of the pending patents on the intellectual property.

54. That RUBENSTEIN, having served as an advisor to the Board of Directors for IVIEWIT, was aware of the fact that at the time of the making of the statements set forth in Paragraph 50, above, IVIEWIT was in the midst of negotiations with AOL/Warner Bros. as to the possible funding of the operations of IVIEWIT in and sum of between \$10,000,000.00 and \$20,000,000.00.

55. Further, RUBENSTEIN as a partner of PROSKAUER, and despite his clear prior actions in representing the interests of IVIEWIT, refused to answer questions as to the enforcement of the Technology of IVIEWIT, with the intent and knowledge that such refusal would lead to the cessation of the business relationship by and between IVIEWIT and Warner Bros./AOL and other clients familiar with the Warner Bros./AOL technology group then in negotiations with IVIEWIT, including, but not limited to Sony Corporation, Paramount, MGM and Fox.

56. That the actions of RUBENSTEIN were and constituted an intentional and unjustified interference with the relationship by and between IVIEWIT and Warner Bros./AOL designed to harm such relationship and further motivated by the attempts to "cover-up" the conflict of interest in PROSKAUER's representation of both IVIEWIT and Warner Bros./AOL.

57. That indeed, as a direct and proximate result of the conduct of RUBENSTEIN, Warner Bros./AOL ceased business relations with IVIEWIT to the

damage and detriment of Counter Plaintiffs.

WHEREFORE, Counter Plaintiffs demand judgement for damages against Counter Defendant together with court costs, interest and such other and further relief as this Court deems just and equitable.

I HEREBY CERTIFY that a true and correct copy of the foregoing has been provided by U.S. Mail and fax transmission this 10th day of January, 2003 to: Christopher W. Prusaski, Esq., Proskauer Rose, LLP, 2255 Glades Road, Suite 340 W, Boca Raton, FL 33431.

SELZ & MUVDI SELZ, P.A.
214 Brazilian Avenue, Suite 220
Palm Beach, FL 33480
Tel: (561) 820-9409
Fax: (561) 833-9715

By: 

STEVEN M. SELZ
FBN: 777420



EXHIBIT R



Calculated Discount Rate:	12.00%				
	Year 1	Year 2	Year 3	Year 4	Year 5
Revenue Potential					
<i>Device OEM Licensing</i>	\$387,491,845	\$410,385,714	\$435,344,087	\$485,758,798	\$543,018,985
<i>Motion Picture Video on Demand ("VOD") Licensing</i>	4,260,793	4,778,426	5,648,251	7,151,662	9,707,205
<i>DVD Encoding/Replication</i>	383,471,325	430,058,359	508,342,628	643,649,599	873,648,447
<i>Appliances (copiers, printers, etc.)</i>	290,618,884	307,789,285	326,508,066	364,319,098	407,264,239
<i>Other Device OEM's (scanners, game boxes, e-books, etc.)</i>	96,872,961	102,596,428	108,836,022	121,439,699	135,754,746
<i>Delivery Systems (terrestrial, ISP, Wireless, etc.)</i>	387,491,845	0	0	0	0
<i>Medical Imaging and Devices</i>	116,247,554	123,115,714	130,603,226	145,727,639	162,905,696
<i>Wireless Devices</i>	271,244,292	287,270,000	304,740,861	340,031,159	380,113,290
<i>Enterprise Software</i>	191,735,663	215,029,179	254,171,314	321,824,799	436,824,224
<i>Internets (auctions, retail games, etc.)</i>	191,735,663	215,029,179	254,171,314	321,824,799	436,824,224
Present Value -- Total Revenue Potential	1,875,454,356	1,670,960,048	1,657,584,195	1,749,351,147	1,921,901,867
Present Value -- Cumulative Revenue Potential	<u>1,875,454,356</u>	<u>3,546,414,404</u>	<u>5,203,998,599</u>	<u>6,953,349,746</u>	<u>8,875,251,614</u>
Present Value -- Cum. Rev. Pot. Over 20-Year Patent Life	<u>\$17,353,552,076</u>				
Assume Percentage of Unsuccessful U.S. Patent Repair	\$6,802,592,414				
Assume Percentage of Forfeiting PCT Protection	<u>3,470,710,415</u>				
Cum. Potential Damages Over 20-Year Patent Life	<u>\$10,273,302,829</u>				



APRIL 1999 LETTER OF MR. WHEELER

Christopher C. Wheeler
Member of the Firm

Direct Dial 561.995.4702
cwheeler@proskauer.com

April 26, 1999

Mr. Richard Rossman
Lewinter and Rossman
16255 Ventura Blvd., Suite 600
Encino, CA 91436

Re: iviewit, Inc.

Dear Richard:

Under separate cover I have forwarded you a revised Confidentiality Agreement.

As you know we have undertaken representation of iviewit, Inc. ("iviewit") and are helping them coordinate their corporate and intellectual property matters. In that regard, we have reviewed their technology and procured patent counsel for them. We believe the iviewit technology is far superior to anything presently available with which we are familiar. Iviewit has filed a provisional patent application on a method for providing enhanced digital images on telecommunications networks. We are advised by patent counsel that the process appears novel and may be protected by the patent laws. While in all matters of this sort, it is far too early to make any final pronouncements, we do believe that there is an extremely good prospect that iviewit will protect their process which is novel and superior to any other format which we have seen.

Very truly yours,

Christopher C. Wheeler

CCW/gb

0894/40017-001 BRLIB 1/227137 v1

04/22/99 03:57 PM (2743)



LETTER OF MR. WHEELER APPEALING TO PARTNERS

Dear Colleagues,

As a firm, we are in a unique position to impact the effectiveness of the Internet and to profit from the same. The firm of iviewit.com, Inc. is one of my clients and Proskauer, Rose, LLP. is a 2.5% shareholder. I have worked closely with iviewit, for the past 18 months, establishing and fine-tuning their corporate structure. My objective with this letter is to introduce you to this forward-thinking company and to ask for your support and assistance.

The Internet is quickly evolving from a text-based medium that users have been forced to read, into a multimedia platform that users can begin to *experience*. The importance that this evolution has to e-commerce has been likened to the impact felt by television when it was embraced as a marketing and communications tool. iviewit's intellectual property positions them as a leader in the streaming video, streaming audio and virtual imaging online markets. Their technologies have broad ranging applications for many different industries including: entertainment, auctions, education, healthcare and retail.

Because of the extensive applicability of iviewit's products, the vast majority of Proskauer's client relationships represent potential clients for iviewit. Please join me as I endeavor to introduce my clients to iviewit and, in the process, help those clients to gain a competitive advantage through the utilization of iviewit's technologies. Please contact me with any opportunities that you identify and I will arrange an introduction to a member of iviewit's management team. I have enclosed a descriptive flyer from iviewit and a multimedia CD-ROM that will serve as an introduction to iviewit. Additional information can be found at their website, www.iviewit.com.

Thank you for your time and attention. I look forward to working together to help this valued client and to further enhance the value of our equity position in iviewit.

Sincerely,

Christopher C. Wheeler



EXHIBIT S



WITNESS LIST

**Statement Regarding Events - Simon L. Bernstein - Past
Chairman of the Board Iviewit**

-----Original Message-----

From: Alyssa Zeiger [mailto:alyssa@lifeinsuranceconcepts.com]
Sent: Friday, May 16, 2003 10:33 AM
To: 'iviewit@worldnet.att.net'
Cc: 'simon@lifeinsuranceconcepts.com'
Subject: FW: response to your letter

Eliot,

Here is my account of those questions you of asked for regarding iviewit Technologies, Inc.

1. Not having Wheeler's testimony it's difficult for me to respond to the 1st question. However, Real 3d (Jerry Stanley) was introduced to us and their opinion including the opinion of their engineering staff was that the patents that we showed them were outstanding and extremely valuable. Mr. Stanley told myself, Eliot, Jerry Lewin and Chris Wheeler that we were onto something big.
2. The problems that were encountered by Ray Joao's work were that is seemed to be incomplete, sloppy and certainly not in a professional manner for which the billings indicated it were. With regard to Foley and Lardner's work, there work also seemed to be incomplete with regard to accomplishing the patent approvals. It was also noted that including work with Mr. Utley they were writing patents in his name.
3. In the same regard Mr. Utley told me when I confronted him with this that it was common for the writer to put new patents in his name but assured me that all patents were assigned to iviewit Technologies, Inc. This was passed on to one of the partners at Proskauer Rose and I was assured that this with in proper conduct.
4. With regard to Ken Rubenstein, I was told by Brian Utley and Chris Wheeler that he was a partner of Proskauer Rose and that he was in fact overseeing our patent work and it also was mentioned that he advised the board of directors with regard to raising capital.
5. It is my opinion that Hank Powell a partner of Crossbow Ventures and also a member of the board of iviewit Technologies, Inc. violated his fiduciary responsibility as said board member to iviewit Technologies, Inc. by recommending iviewit Technologies, Inc. move forward and securing additional loans from Crossbow Ventures. He also told me that Crossbow had no intention of ever collecting on the notes but in fact it gave further protection of iviewit Technologies, Inc. from any other creditors. It is my opinion that this convinced the board of directors to vote on such loans.

6. With regard to Chris Wheeler's recommendation of Bryan Utley it's my opinion that he knew of the past problems Mr. Utley had with Monte Friedkin and withheld this information to myself and to Eliot.
7. My understanding of the relationship between Mr. Utley and Mr. Wheeler is that they are good friends both socially and professionally. Also they served on many boards together.

I believe this covers the pertinent questions you asked me for. I hope this helps.

Wednesday, April 30, 2003

Mr. Eliot I. Bernstein
10158 Stonehenge Circle
#801
Boynton Beach, FL. 33437-3546

Dear Eliot,

I have spent the past several evenings reviewing the depositions taken from Wheeler, Utley and Rubenstein and I am stunned. The extent of their lies and their orchestrated obfuscation compels me to reduce to writing some of the experiences that I had with these men. Please use this letter and the statements contained herein as my sworn statement of fact in your continuing effort to expose the truth, punish the evil and reward the deserving.

As a friend of Eliot's, since childhood, I was aware of iviewit from its beginnings but it was only after learning from Chris Wheeler about Ken Rubenstein's favorable opinion regarding iviewit's video and imaging technologies that I became seriously interested in the company. I resigned from a lucrative senior management position with Prudential Securities to help Eliot with his "project". Ultimately, I invested over \$20,000 and declined significant career opportunities in order to begin formally working for iviewit in the fall of 1999. Amongst the most egregious of the statements contained in the depositions is that made by Ken Rubenstein when he claims he does not know iviewit or anything about its technologies or processes. Ken is one of the primary reasons why I and many others invested their time and resources in the company. It was the extremely positive opinions of this highly respected attorney, who has direct links to the MPEG patent pool, which compelled so many of us to make the commitments that we made. Mr. Rubenstein is lying in his deposition.

Similarly, Chris Wheeler denies having any role in the patent work performed for iviewit other than referring us to patent counsel that ultimately ripped us off (but that's a different issue). Eliot, you have done a fine job putting together the billing evidence which is irrefutable. Not only did Wheeler play an instrumental and ongoing role in the handling of the patents, he was the primary contact point with Ken Rubenstein. I also remember Chris, in a meeting held at Real 3D, espousing the novelty of iviewit's inventions and discussing the apparent absence of any prior art in this area. In addition, Chris publicly shared Ken Rubenstein's opinion that the iviewit technologies were "novel". It was during this meeting of Intel and Lockheed engineers that a member of Real 3D's senior management, Rosalie Bibona, stated that iviewit's inventions could be worth billions of dollars. Wheeler states in his deposition that he was unfamiliar with any video inventions until sometime after the Real 3D meeting. Mr Wheeler is lying and everyone present at that meeting can testify to that fact. I was at a meeting held at Si Bernstein's house where Eliot Bernstein, Gerry Lewin, Chris Wheeler, Si Bernstein and Hassan Mia were in attendance. This meeting took place prior to the Real 3D meeting and its purpose was to show Hassan the video streams. It was at this meeting that

Hassan Mia stated "... if what I'm seeing is true, you've found the Holy Grail". The term "Holy Grail" can be found in many early versions of iviewit's business plans.

Let's talk about Brian Utley. This man is a stammering buffoon. Were it not for his resume full of accomplishments and the glowing recommendation of our trusted counsel, he probably never would have passed an initial candidate screening. Unfortunately, we learned too late that many of Brian's accomplishments were fabricated and our trusted advisor, Chris Wheeler, was a liar. I remember a meeting of Eliot, Guy Iantoni, Brian Utley, Mike Reale, Si Bernstein, Chris Wheeler and two investment bankers from Wachovia, Mr. Joe Lee and his associate (I forget his name). Guy and I had prepared a detailed sales forecast that Joe Lee later referred to as the most complete and detailed he'd ever seen. Brian's task was to complete the financials for Joe's review. The work that he presented to Joe Lee was pitiful; it was incomplete, inaccurate and inadequately referenced. In short, it was a disastrous embarrassment. We soon learned that that was the best Utley could deliver. Joe Lee insisted that I complete the financial projections for the business plan and that Utley be removed from the project. This is the sort of talent that our trusted advisor, Chris Wheeler, brought to his client!

From unauthorized patent disclosure to Danny Sokoloff without the protection of an NDA to outright patent sabotage through the use of bad math in patent applications, Utley never failed to disappoint. He was equally inept in corporate matters. I notified Brian on numerous occasions of the firm's responsibility to communicate to shareholders at least once per year and that iviewit was in default on its notes for not having made an interest payment. Like a child, he chose to bury his head in the sand instead of addressing the problem. His exorbitant use of T&E monies is legend and is only exceeded by his inability to complete a sentence without the excessive use of the word "um".

As they say, "hindsight is 20/20". In this case, it's now clear that Wheeler never had iviewit's interests in mind. He was positioning himself and his friends to benefit from iviewit's inventions and creativity. What makes his crime so heinous is that he masqueraded as our friend.

Sincerely,

James F. Armstrong
126 Buttonwood Drive
Fair Haven, NJ. 07704
732-747-4353
email: jimarmstrong@comcast.net

Date: 12/11/02

Dear Eliot;

I wanted you to know how I feel about all that I have read recently. As a shareholder and someone that has been around this company since the beginning, I don't know how lawyers like Chris Wheeler and law firms like Proskower Rose could allow statements in a business plan that are not true. Therefore, if the business plan were correct then Mr. Utley would have to be lying under oath. In today's world of fair disclosure, this kind of inconsistency makes me outraged. As a shareholder I encourage and would support action taken to bring any wrongdoing to justice. If nothing else, I am unwilling to allow these deceptions to continue. We should pursue action and be compensated for wrongdoing. I know that if Mr. Rubinstein had not been involved with Iviewit it would have significantly affected my decision to contribute funds when I did. His involvement was communicated to me by Mr. Utley, Mr. Wheeler as well as other involved with the company but as legal representation and president of the company they carried the greatest weight. These inconsistencies are unacceptable and criminal in my opinion. What can we do to bring resolution to this situation and whom do we hold accountable?

Sincerely;

Mitchell A. Welsch, CFP

Mitchell A. Welsch CFP

Eliot I Bernstein

From: Tony Frenden [t.rex@sbcglobal.net]
Sent: Thursday, May 15, 2003 10:21 PM
To: iviewit@bellsouth.net
Subject: Fw: statement

----- Original Message -----

From: Tony Frenden
To: iviewit@worldnet.att.net
Sent: Wednesday, May 14, 2003 11:38 PM
Subject: statement

May 14, 2003

I swear the following to be true:

Upon the closure of the Iviewit office in Boca Raton FL, I was retained for about an extra week by Brian Utley and Mike Reale, assisting in shutting down operations. It was during this time in which Mike Reale entered the video encoding lab, where I was present along with Tammy Raymond, (former Head of IT) and Zakirul Shirajee (former Systems Developer). Reale was smiling broadly as he set down a large silver suitcase onto my computer desk. Upon opening it, he revealed rows and rows of one hundred dollar (\$100) bills in U.S. currency, going down as deep as the case. I would estimate the amount to be near a half million dollars. Upon my inquiry of the where the cash came from, Reale said it was from Bruce Prolow. He implied that the money was entrusted to he and Utley to continue Iviewit operations, but to me, it seemed Reale was careful to never explicitly state that Prolow authorized this transaction or not.

It is my belief that the suitcase of money was presented to me, in front of Tammy and Zakirul, to convince us that Utley and Reale were the ones reaping benefits from the Iviewit core processes, and if we were smart, we should join them.

A day or two prior to this incident, Mike Reale called me into a private office. He spoke of a new operation he and Utley wanted to embark on which utilizes Iviewit's core processes. The plan consisted of encoding video porn at an ambiguous island location in Puerto Rico. It was known that Eliot Bernstein had made available the option for me to work at the newly forming Iviewit in Glendale, CA. Reale wanted to steer me from going to the West coast operation, and spoke of me receiving a title and large pay raise should I go along with the Puerto Rico porn plan, instead.

Also, on one of these last closure days at the Boca Raton offices, Mike Reale approached me in the lab regarding another issue. He inquired which computers would be best to use, if one were to have the need to process Iviewit's core technologies. He asked me which 3 were the strongest computers to do the job. I had a feeling that he wanted to make off with whichever units I spoke of. I had already begun to make up my mind that I wanted no part of the Puerto Rico porn operation, so I told him about 3 computers I didn't care for. They were called, **THE BOMBER**, **THE REELTIME NITRO**, and one more unnamed computer. These were all very powerful and expensive units, but were not necessarily suited to encode video. As expected, these 3 units turned out to be the same ones found in Brian Utley's possession, months later. When the cops returned the items to us, the units

5/31/2003

contained several new media files, mostly long distance learning applications which were created well after the Boca offices were closed down.

Anthony Rex Frenden
859 Hollywood Way #374
Burbank CA 91505

Incoming mail is certified Virus Free.
Checked by AVG anti-virus system (<http://www.grisoft.com>).
Version: 6.0.480 / Virus Database: 276 - Release Date: 5/12/2003

Partial Witness List Raymond Joao

Mitchell Welsch - Shareholder
UBS/Paine Webber Inc.
5 Radnor Corporate Center
100 Matsonford Road
Suite 444
Radnor, PA 19087
(800) 942-0409 ext7251

Jeffrey & Lisa Friedstein - Shareholders
Goldman Sachs Group, Inc.
4900 Sears Tower
Chicago, IL 60606
(800) 233-9622

Donald G. Kane II – Shareholder & Board Member
540 Dalewood Lane
Hinsdale, IL 60521
(630) 325-5622

Simon L. Bernstein – Shareholder & Past Chairman of the Board
7020 Lions Head Lane
Boca Raton, FL 33496
(561) 988-8984

Zakirul Shirajee - Inventor
9485 Boca Cove Circle
Apt. #708
Boca Raton, FL 33428
(561) 487-1110 x413

Jude Rosario – Inventor
Last known address
5580 NW 61 Street
Apt. 625
Coconut Creek, FL 33073
(561) 451-4900 ext 413

Jill Iantoni – Shareholder and Ex-Employee
American Express
(312) 634-4713

Guy Iantoni – Shareholder and Ex-Employee
Strategica Technologies, Inc.
2101 Magnolia Lane
Highland Park, IL 60035
(847) 831-9416

James F. Armstrong – Shareholder and Ex-Employee

126 Buttonwood Drive
Fair Haven, NJ. 07704
(732) 747-4353

Kenneth Anderson, CPA – Board Member & Shareholder
Director
myCFO Inc.
2029 Century Park East
Suite 800
Los Angeles, California 90067
(310) 407-1170

Maurice Buchsbaum – Shareholder, Board of Director member, Ex-Employee
Emerald Capital Partners, Inc.
20805 Cipres Way
Boca Raton, FL 33433
(561) 483-8016

Michele M. Mulrooney, Esq. - Shareholder
Armstrong Hirsch Jackoway Tyerman & Wertheimer
1888 Century Park East
Suite 1888
Los Angeles, California 90067-1702
(310) 553-0305

Alan Epstein, Esq. – Shareholder – Advisory Board member
Armstrong Hirsch Jackoway Tyerman & Wertheimer
1888 Century Park East
Suite 1888
Los Angeles, California
(310) 553-0305

Candice Bernstein – Shareholder and Ex-Employee
10158 Stonehenge Circle
Suite 801
Boynton Beach, FL 33437-3546
(561) 364-4240

Jennifer A. Kluge
Last Known Address
3100 N.E. 49th St.
Apt.#905
Ft. Lauderdale, FL 33308
(954) 772-6444

Erika Lewin, CPA
7050 Ayrshire Lane
Boca Raton, FL 33496
(561) 883-5792

Caroline Prochotska Rogers, Esq.
3500 North Lake Shore Drive
17th Floor
Chicago, IL 60657
(312) 498-1444



[INSERT JOAO COMPLAINT]

[INSERT JOAO RESPONSE]

[INSERT JOAO REBUTTAL]



EXHIBIT C



[INSERT WHEELER COMPLAINT]

[INSERT WHEELER RESPONSE]

[INSERT WHEELER REBUTTAL]

[INSERT WHEELER SECOND RESPONSE]

[INSERT COMPANY'S SECOND REBUTTAL]



EXHIBIT D



LIST OF PROSKAUER CLIENTS CONDUCTING UNAUTHORIZED USE

Visual Data Corp.
Warner Bros.
AOL Time Warner
Deutsche Telekom
Boca Research (acquired by Zoom Telephonics, Inc.)
Intel Corp. (acquired Real 3D)
SGI, Inc. (prior to Intel's acquisition of Real 3D)
Lockheed Martin Corp (prior to Intel's acquisition of Real 3D)
Eclipsys Corp.
SONY
Viacom
Blockbuster
Citrix Systems
Columbia/Tri-Star
Disney
Ronald G. Assaf and Sensormatic Electronics Corp.
Teranex
MPEG LA, LLC (MPEG 2 and MPEG 4)
DVD 6C Licensing Agency (DVD)
Hollywood.com
Florida Atlantic University



HAND NOTES OF MR. WHEELER POINTING TO NDA BREACHES

11 Jan 00
C in Pay Pass

Based on Bin's work ->

Define element -> depend on data level
based on tools we are using today -
everything is in public domain -
parameters of such a nature - little
if anything we can claim or patentable -
tools are very much in public domain -

his claim -> the tools as creative ideas -
breached confidentiality agreement -
problem occurred with Hassan Rich -
integrated into their product -
steps became integrated into Dayle card -
he believes that Hassan Rich -
collectively learned and -> to go
boards and receiver -

Basis for any action -> breach of contract -
when phase + how process worked -
paper trail -

PROSK0112

Capture + mode - 2 steps
today -

originally - no process that took you
from capture to mode -

copy of non-documented that Herson
Must signed -

Client should consider - any patents for the
video → doesn't wear out of and
around it -

Collaborate level of development



EXHIBIT E



MR. BERNSTEIN TRANSMITS INVENTIONS TO RESPONDENT⁴⁶

-----Original Message-----

From: Eliot Bernstein [mailto:alps@netline.net]
Sent: Tuesday, February 23, 1999 7:53 AM
To: Kenneth Rubenstein (E-mail); Christopher C. Wheeler (E-mail)
Subject: Please call when you receive this message. 800.519.0234 or
561.417.8980

Ken,

Per our discussion, I have attached the following file = [process.doc](#).

Eliot

<< File: ATT00027.html >> << File: PROCESS.doc >>

⁴⁶ The first in a series of electronic mail messages that the Company cannot attest to the validity of, but requests First Judicial Department Disciplinary Committee to obtain the matching messages from Respondent's files as much "hacking" has gone on with respect to the Company's information systems.



**RESPONDENTS VISITS PROPRIETARY AND CONFIDENTIAL PAGE OF
COMPANY S WEBSITE ⁴⁷**

-----Original Message-----

From: Eliot Bernstein [mailto:alps@netline.net] On Behalf Of
webmaster@cyberfyds.com
Sent: Thursday, January 28, 1999 4:08 PM
To: 'krubenstein@proskauer.com'
Subject: FW: Crime Watch

iviewit Confidentiality Agreement

The undersigned reader acknowledges that the information provided by Iviewit and Simon & Eliot Bernstein in this business plan and at the specified iviewit website is confidential; therefore, reader agrees not to disclose it without the express written permission of Simon L. Bernstein. This memorandum does not constitute an offer to sell, or a solicitation of an offer to purchase, securities. This business plan has been submitted on a confidential basis solely for the benefit of selected, highly qualified investors and is not for use by any other persons. Neither may it be reproduced, stored, or copied in any form. By accepting delivery of this plan, the recipient acknowledges and agrees that: i) in the event the recipient does not wish to pursue this matter, the recipient will return this copy to iviewit, at the address listed below immediately; ii) the recipient will not copy, fax, reproduce, or distribute this Confidential Business Plan or iviewit web address, in whole or in part, without written permission; iii) all of the information contained herein will be treated as confidential material. Agreement executed by the recipient prior to, or contemporaneously with, its receipt of this Confidential Business Plan

Name: Ken rubenstein E-mail: krubenstein@proskauer.com

⁴⁷ *Supra* Note 45.



RESPONDENT ADVISES MR. BERNSTEIN ON PATENT OVERSIGHT

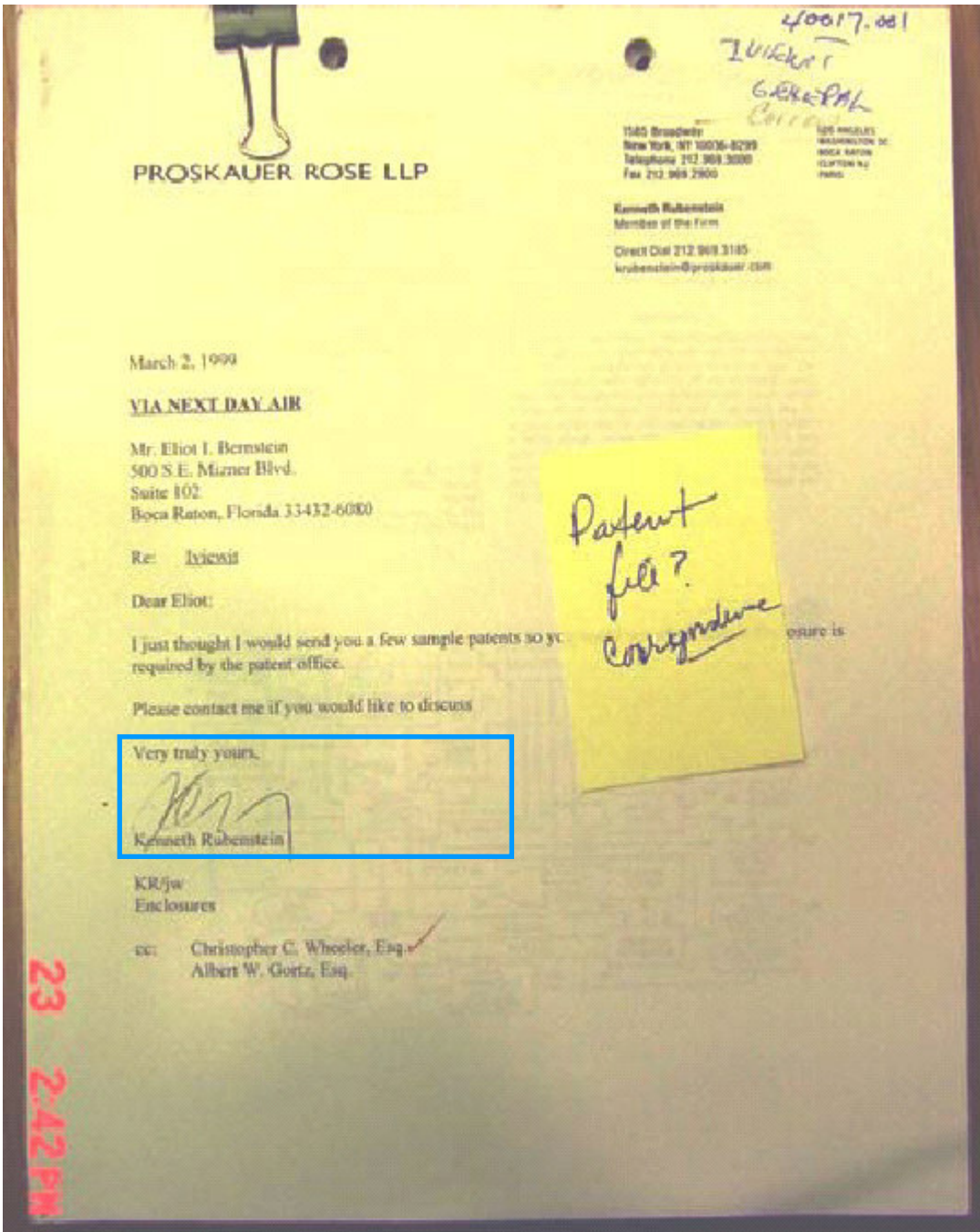

PROSKAUER ROSE LLP

1140 Broadway
New York, NY 10016-8299
Telephone 212 969-3000
Fax 212 969-2900

100 ANGLIS
WASHINGTON DC
BOCA RATON
CLIFTON NJ
PHILADELPHIA

Kenneth Rubenstein
Member of the Firm
Direct Dial 212 969 3185
krubenstein@proskauer.com

March 2, 1999

VIA NEXT DAY AIR

Mr. Eliot I. Bernstein
500 S.E. Mizner Blvd.
Suite 102
Boca Raton, Florida 33432-6000

Re: *lycrist*

Dear Eliot:

I just thought I would send you a few sample patents so you are
requisitioned by the patent office.

Please contact me if you would like to discuss

Very truly yours,

[Signature]
Kenneth Rubenstein

KR/jw
Enclosures

cc: Christopher C. Wheeler, Esq.
Albert W. Goetz, Esq.

*Patent
file?
Co-sponsor*

23 2:42 PM



MR. WHEELER TRANSMITS PATENT BINDERS TO RESPONDENT

PROSKAUER ROSE LLP

NEW YORK
LOS ANGELES
WASHINGTON DC
BOCA RATON
CLIFTON NJ
PARIS

Intraoffice Memo

Re: iviewit.com, Inc.
To: Kenneth Rubenstein
From: Christopher C. Wheeler
Date: August 25, 2000
Client-Matter: 40017.001

Enclosed is a copy of iviewit's Patent Portfolio binder.

PROSK000536

0894/40017-001 BRLIB1/274961 v1

08/25/00 05:37 PM (11402)



LETTER OF MR. WHEELER POINTING TO RESPONDENT S REVIEW OF COMPANY S INVENTIONS

APR 26 1999 18:04 FR PROSKAUER ROSE

561 241 7145 TO 2410071#

P.01/02

2255 Glades Road
Suite 340 West
Boca Raton, FL 33431-7360
Telephone 561.241.7400
Elsewhere in Florida
800.432.7746
Fax 561.241.7145

NEW YORK
LOS ANGELES
WASHINGTON DC
CLIFTON NJ
PARIS

PROSKAUER ROSE LLP

Date April 26, 1999

Client-Matter 0894/40017/001

Fax Transmittal

Total Pages (including Cover) 2

From Christopher C. Wheeler

Sender's Room Number

Sender's Voice Number 561.995.4702

Main Fax Operator 561.241.7400

To Eliot I. Bernstein

Fax No. 417.4470

Company iviewit

Voice No. 417.8980

To Jerry Lewin

Fax No. 241.0071

Company Goldstein Lewin

Voice No. 994.5050

Message

Confidentiality Note: This message is confidential and intended only for the use of the addressee(s) named above. It may contain legally privileged material. Dissemination, distribution or copying of this message, other than by such addressee(s), is strictly prohibited. If you have received this message in error, please immediately notify us by telephone and return the original to us at the address above. We will reimburse you for the cost of the telephone call and postage. Thank you.

0894/40017-001 BRJ1/219712 v1

02/18/99 02:28 PM (2743)



PROSKAUER ROSE LLP

2255 Glades Road
Suite 340 West
Boca Raton, FL 33431-7360
Telephone 561.241.7400
Elsewhere in Florida
800.432.7746
Fax 561.241.7145

NEW YORK
LOS ANGELES
WASHINGTON
NEWARK
PARIS

Christopher C. Wheeler
Member of the Firm

Direct Dial 561.995.4702
cwheeler@proskauer.com

April 26, 1999

Mr. Richard Rosman
Lewinter and Rosman
16255 Ventura Blvd., Suite 600
Encino, CA 91436

Re: iviewit, Inc.

Dear Richard:

Under separate cover I have forwarded you a revised Confidentiality Agreement.

As you know we have undertaken representation of iviewit, Inc. ("iviewit") and are helping them coordinate their corporate and intellectual property matters. In that regard, we have reviewed their technology and procured patent counsel for them. We believe the iviewit technology is far superior to anything presently available with which we are familiar. iviewit has filed a provisional patent application on a method for providing enhanced digital images on telecommunications networks. We are advised by patent counsel that the process appears novel and may be protected by the patent laws. While in all matters of this sort, it is far to early to make any final pronouncements, we do believe that there is an extremely good prospect that iviewit will protect their process which is novel and superior to any other format which we have seen.

Very truly yours,

Christopher C. Wheeler

CCW/gb



EXHIBIT F



RESPONDENT S BIOGRAPHY ON PROSKAUER S WEBSITE

Biography:

Ken received his [Ph.D. in physics](#) from the Massachusetts Institute of Technology where he also graduated with a B.S. Degree.

Ken received his law degree, cum laude, from New York Law School. He is a registered patent attorney before the U.S. Patent & Trademark Office. Ken is a former member of the legal staff at Bell Laboratories. While there are numerous patent law groups at various firms, Ken and his group distinguish themselves from competitors by being able to deal with very sophisticated technology.

Ken and his group are currently undertaking a number of significant patent and high tech litigations. The group is representing Alcatel, one of the world's leading telecommunications equipment companies, in a major trade secret case against a competitor. The group is also representing Standard Microsystems in a litigation related to Fast Ethernet LANs, Hauppauge Computer in a litigation involving video cards for personal computers, and System Management Arts in a litigation involving object oriented software. The group has also been involved in patent litigation relating to semiconductor memories and service platforms for providing enhanced telecommunications services.

Ken has [worked on the formation of a patent pool for MPEG-2 technology](#), first on behalf of CableLabs, the research and development consortium of the cable TV industry, and now on behalf of MPEG LA LLC, an entity set up to license MPEG-2 essential patents. In particular, [Ken worked on selecting those patents which are "essential" to the MPEG-2 standard and therefore suitable for inclusion in the pool.](#) He worked with major consumer electronics companies and set top makers in doing this job. Under this arrangement, the MPEG-2 "essential" patents of a number of major companies are being made available in a single license. The pool has been operational [since July 1997](#) and now has over one hundred and fifty licensees and royalty revenues in nine figures.

This pioneering approach to licensing has been utilized in other contexts. Ken and his associates are [now working on another patent pool involving large consumer electronics and entertainment companies concerning DVD technology.](#)

Ken's group is also working on evaluating patents for a pool for the IEEE 1394 standard which is related to interconnecting PCs and various peripherals and a pool for the HAVi standard which is related to interconnection of home audio/video devices.

Ken counsels his clients with respect to the validity and infringement of competitors' patents. Such clients include Standard Microsystems, an IC and local area network component company; [C-Cube Microsystems](#), a developer of video encoder and decoder chips; [Divicom](#), a developer of video encoders and decoders; Starlight Networks, a developer of video server software; and Maker Communications, Inc., a developer of telecommunications integrated circuits. In the area of cryptography, Ken represents Telcordia and CableLabs. He has in the past also represented Tele-TV, a joint venture of NYNEX, Bell Atlantic and Pacific Telesis.

Ken is also heavily involved in licensing, technology transfer and joint development. Ken has successfully concluded a number of license and technology transfer agreements for his clients with companies such as Lucent and Intel.

Ken and his wife, Randee, a social worker, have four children, Ari, Sara, Debbie and Rebecca. Ken enjoys baseball and reading, especially history books.



LETTER OF MR. WHEELER APPEALING TO PARTNERS

Dear Colleagues,

As a firm, we are in a unique position to impact the effectiveness of the Internet and to profit from the same. The firm of iviewit.com, Inc. is one of my clients and Proskauer, Rose, LLP. is a 2.5% shareholder. I have worked closely with [iviewit](http://iviewit.com), for the past 18 months, establishing and fine-tuning their corporate structure. My objective with this letter is to introduce you to this forward-thinking company and to ask for your support and assistance.

The Internet is quickly evolving from a text-based medium that users have been forced to read, into a multimedia platform that users can begin to *experience*. The importance that this evolution has to e-commerce has been likened to the impact felt by television when it was embraced as a marketing and communications tool. [iviewit](http://iviewit.com)'s intellectual property positions them as a leader in the streaming video, streaming audio and virtual imaging online markets. Their technologies have broad ranging applications for many different industries including: entertainment, auctions, education, healthcare and retail.

Because of the extensive applicability of [iviewit](http://iviewit.com)'s products, the vast majority of Proskauer's client relationships represent potential clients for [iviewit](http://iviewit.com). Please join me as I endeavor to introduce my clients to [iviewit](http://iviewit.com) and, in the process, help those clients to gain a competitive advantage through the utilization of [iviewit](http://iviewit.com)'s technologies. Please contact me with any opportunities that you identify and I will arrange an introduction to a member of [iviewit](http://iviewit.com)'s management team. I have enclosed a descriptive flyer from [iviewit](http://iviewit.com) and a multimedia CD-ROM that will serve as an introduction to [iviewit](http://iviewit.com). Additional information can be found at their website, www.iviewit.com.

Thank you for your time and attention. I look forward to working together to help this valued client and to further enhance the value of our equity position in [iviewit](http://iviewit.com).

Sincerely,

Christopher C. Wheeler



PROSKAUER S CLIENT LIST WHEREIN MR. WHEELER PLACES A CHECK MARK NEXT TO RESPONDENT S CLIENTS

PROSKAUER ROSE LLP

NEW YORK
LOS ANGELES
WASHINGTON
BOCA RATON
NEWARK
PARIS

Representative Proskauer Clients

Listed below are a number of clients for whom Proskauer Rose LLP is currently performing legal services.

- | | | |
|---|--|--|
| ✓ Accor (hotels) | Arthur Andersen & Co. | Bostik, Inc. |
| Aerospatiale | ✓AT&T | Bristol-Myers Squibb Company |
| Air India | ✓Autodesk, Inc. <i>AUTODESK</i> | The Broadway Initiative Corporation |
| Alarm Device Manufacturing Co. | Avis Rent-A-Car System | Brookdale Hospital Medical Center |
| ✓ Alcatel (Telecom - DSL) | The George Balanchine Trust | The Brooklyn Hospital Center |
| Allegheny Health, Education and Research Foundation | ✓Bally Shoes | ✓Brooks Brothers |
| ✓ Alliance of Motion Picture and Television Producers | Banca del Sempione | Building Services Funds |
| ✓ The Alpine Group, Inc. <i>Alpine Vision subsidiary</i> | Bancol S.A. | Bull Run Corporation |
| Alton Ochsner Medical Foundation | Bank United of Texas FSB | Business Software Alliance |
| Amerada Hess Corporation | Banque Privée Edmond de Rothschild | ✓Buster Brown Apparel, Inc. |
| American Federation of Musicians and Employers' Pension Fund | Baring Communications Equity Limited | Cafe des Artistes |
| ✓ American League of Professional Baseball Clubs | ✓Barneys New York | Canal Capital Corporation |
| ✓ ATP Tour, Inc. (Tennis) | ✓Bear, Stearns & Co. Inc. | ✓ABC, Inc. |
| AFTRÄ Health & Retirement Funds | Becton Dickinson | ✓Careers USA |
| The Albert Fisher Group PLC | BDO Seidman | Castle Oil Corporation |
| American Jewish Committee | ✓Bed Bath & Beyond Inc. | ✓CBS, Inc. |
| American Maritime Congress | Bell Atlantic Asset Management Co. | Celadon Group, Inc. |
| ✓ The American Society for the Prevention of Cruelty to Animals | ✓Bell Atlantic Corporation | Celgene Corporation |
| Anden Group | ✓Benetton Group, Spa. | ✓Center for Missing & Exploited Children |
| ✓Andersen Consulting | Berkshire Capital Corporation | Ceridian Benefits Services, Inc. |
| Antigenics | Estate of Leonard Bernstein | Chambers Development Co., Inc. |
| Apollo Real Estate Advisors, LP | Beth Israel Medical Center | Champion International Corporation |
| ✓Arena Football LLC | ✓ Beverly Enterprises <i>acquired from B&B</i> | C&D Technologies, Inc. |
| ✓Arista Records | ✓Big Flower Holdings, Inc. | Charterhouse Group |
| | Biovail Corporation International | Charter Technologies, Inc. |
| | ✓ Blair Industries, Inc. | The Chase Manhattan Bank |
| | ✓BMG Entertainment | ✓Chrysler Corp. |
| | Bollere Technologies | |

PROSK0454



PROSKAUER ROSE LLP

- Ciba Specialty Chemicals Corporation
- CIBC World Markets Corp.
- ✓ Citibank, N.A.
- ✓ City Center of Music & Drama
- ✓ City of New York
- Clal (Israel) Ltd.
- Club Méditerranée, S.A.
- ✓ Columbia Pictures Industries, Inc.
- Colgate-Palmolive Co.
- Columbia University
- ✓ Communications Equity Associates Inc.
- Community Health Care Physicians P.C.
- La Compagnie Financiere Edmond de Rothschild Banque
- NS* ✓ Computer Horizons Corp.
- Comtech Telecommunications
- Consolidated Edison Company of New York, Inc.
- Consumers Union of United States
- Cooper Union
- The Joseph and Robert Cornell Memorial Foundation
- ✓ Countdown Entertainment
- Craig Enterprises
- Credit Lyonnais
- Credit Suisse First Boston
- ✓ Cross Country Staffing
- CSS Industries, Inc.
- CV Reit
- Daily News, L.P.
- The Darnon Company, Inc.
- Dean Foods of California
- ✓ DELIA*s
- Deloitte & Touche
- Demolition Worker's Funds
- The Depository Trust Company
- The Edmond de Rothschild Foundation de Sede A.G.
- Development Corporation for Israel
- ✓ The Donna Karan Company
- Douglas Elliman
- Dow Jones & Company
- ✓ The Dress Barn, Inc.
- The Dun & Bradstreet Corporation
- Eagle National Bank of Miami, N.A.
- EOS Corporation
- Richard A. Eisner & Company, LLP
- El Diario/La Prensa
- ✓ EMI Music Publishing
- Equitable Life Assurance Society of the United States
- Environmental Systems Products
- Ernst & Young LLP
- European American Bank
- EURO RSCG Holdings, Inc.
- ✓ Ferrari North America
- ✓ Fiat U.S.A., Inc.
- ✓ Finlay Fine Jewelry
- First Union National Bank
- Flushing Savings Bank
- Foot Cone & Belding
- The Ford Foundation
- ✓ Forte Hotels
- Fuji Bank, Ltd.
- General Building Laborer's Funds
- Generic Pharmaceutical Industry Association
- Genlyte Thomas LLC
- GFI Securities Group
- ✓ Giant Group, Ltd.
- ✓ Golden Books Entertainment Company, Inc.
- Golden Books Family Entertainment, Inc.
- Gotham Construction Corporation
- GNB Bank
- ✓ Grace Plaza of Great Neck, Inc. *(inversing h)*
- Greater New York Hospital Association
- G.T.E. (General Telephone & Electric)
- ✓ Happy Kids, Inc.
- Estate of Keith Haring
- Harvard Custom Manufacturing, Inc.
- ✓ Havas Advertising
- ✓ The Hearst Corporation
- Henry Schein, Inc.
- Hermes of Paris, Inc.
- Lauryn Hill
- H. J. Baker & Bro., Inc.
- ✓ Home Box Office
- ✓ Home Depot U.S.A., Inc.
- ✓ Home Shopping Network, Inc.
- Hospital for Special Surgery
- HR Textron
- Humana Inc.
- Hutchinson S.A.
- Iberia Airlines
- IBJ Schroder Bank & Trust Company
- ICN Pharmaceuticals, Inc.
- IDB Holding Corporation Ltd.
- Insignia Financial Group, Inc.
- ✓ Interscope Records
- Interstate Brands Corporation
- Invesco
- ✓ Island Records
- Israel Discount Bank of New York
- ITQCHU International, Inc.
- ✓ iTurf



PROSKAUER ROSE LLP

- Japan Air Lines
- Jenny Craig, Inc.
- Jerusalem Capital Studios
- The Joseph and Robert Cornell Memorial Foundation
- J.P. Morgan & Co., Incorporated
- ✓ Kaleidoscope Films
- ✓ Kapson Senior Quarters Corp. *Spring homes*
- Key Biscayne & Trust Company
- Keystone Shipping Co.
- ✓ King World Productions, Inc.
- Kinray, Inc.
- Kontron Instruments
- Korea Asset Management Corp.
- Korea District Heating Corporation
- Korea Electric Power Corporation
- Kraft Foods, Inc.
- KR Capital Advisors
- The Laird Group Plc.
- Lakeside Industries
- Lally McFarland & Pantello
- Lazard Freres & Co.
- ✓ The League of American Theatres and Producers, Inc.
- League of Voluntary Hospitals and Homes of New York
- Le Meridien Hotel & Resorts
- Lenox Hill Hospital
- Levitt Homes Incorporated
- Liberty Fabrics/Courtauld Textiles
- ✓ Lifetime Entertainment Services
- ✓ Lincoln Center for the Performing Arts, Inc.
- Lincolnshire Management, Inc.
- LG Group
- L.J. Hooker Corporation, Inc.
- Lone Star Industries, Inc.
- ✓ Madison Square Garden Corp.
- ✓ Madonna
- Maimonides Medical Center
- ✓ Major League Soccer
- Marchon & Marcolin Eyewear, Inc.
- Marcus Brothers Textiles, Inc.
- Maritime Service Committee
- Marubeni America Corporation
- Mason Tenders' District Council Trust Funds
- Matson Navigation Company, Inc.
- MBIA Insurance Corporation
- McDonald's Corporation
- McKinsey & Company, Inc.
- Medical Group Council
- MediaCopy Inc.
- Memorial Sloan Kettering Cancer Center
- ✓ Mennen Medical Ltd.
- The Merchandising Group, LLC
- Meridien Hotels
- Merrill Lynch & Co., Inc.
- Methodist Hospital of Southern California
- ✓ Metro-Goldwyn-Mayer
- Metro-North Commuter Railroad
- Metropolitan Life Insurance Co.
- Metropolitan Opera Association
- Micromedia Affiliates, Inc.
- Microwave Power Devices, Inc.
- Milberg Factors, Inc.
- ✓ Milford Plaza Hotel
- ✓ Miller Brewing Company
- Edward J. Minskoff Equities, Inc.
- ✓ Miss Universe, Inc.
- ML Media Partners
- Montefiore Medical Center
- Moran Towing & Transportation Co., Inc.
- Mormac Marine Transport
- Motel 6
- Mount Sinai-NYU Medical Center
- Moxon Corporation
- Museum of Discovery & Science
- ✓ Museum of Modern Art
- ✓ National Artists Management Company, Inc.
- National Bank of Pakistan
- ✓ National Basketball Association
- ✓ National Broadcasting Company
- The National Governors' Ass'n
- ✓ National Hockey League
- NKO, Inc.
- The National Law Journal
- ✓ National League of Professional Baseball Clubs
- National Notary Association
- National Syndications Inc.
- NationsBank of Florida N.A.
- ✓ NBA Properties, Inc.
- The Nederlander Organization
- ✓ Network Event Theater, Inc.
- ✓ New Jersey Performing Arts Center
- Newkirk Management Corp.
- ✓ New Line Cinema
- New York Blood Center
- ✓ New York City Ballet
- ✓ New York City Opera
- New York City Transit Authority
- New York Eye & Ear Infirmary
- ✓ New York Convention Center Operating Corporation (Javits Center)
- New York Law Journal
- New York Philharmonic
- New York Presbyterian Hospital
- New York Public Library



PROSKAUER ROSE LLP

- New York State Bankers Ass'n
- New York Stock Exchange
- The New York Times
- ✓ NHL Enterprises
- Nidera S.A.
- ✓ Nine Inch Nails
- NMU Pension & Benefits Plan
- North Shore Long Island Jewish Medical Center
- NorthStar Presidio Management Company, LLC
- ✓ Nothing Records
- Oppenheimer & Company
- Oppenheimer Capital
- Optomic Medical Technologies Ltd.
- Overseas Shipholding Group, Inc.
- Pathmark Stores, Inc.
- PEC Israel Economic Corporation
- PP&L Inc.
- Philips Electronics North American
- ✓ Pergament Home Centers, Inc.
- ✓ Philadelphia Eagles
- Pirelli Tire LLC
- Pirelli Cables and Systems LLC
- Pitney Bowes
- ✓ Pivotal Group, Inc.
- Polytechnic University
- Pratt Institute
- Presidio Capital Corp.
- Price Communications Corporation
- ✓ Prince Sports Group, Inc. / Nordica/Rollerblade
- Provident Investment Counsel, Inc.
- Prudential Insurance Company of America
- Prudential Securities Incorporated
- Radio City Productions, Inc.
- ✓ The Rainbow Room
- Ranbaxy Laboratories Limited
- Ranieri & Co., Inc.
- The Reader's Digest Association, Inc.
- Realty Advisory Board
- ✓ Recording Industry of America
- ✓ Red Apple Group
- Reeves Industries, Inc. Capital Related Capital Company
- Republic National Bank of N.Y.
- Restaurant Associates Corp.
- Reynolds Metals Company
- Rhodia Inc.
- Riddell, Inc.
- The Rockefeller Group, Inc.
- The Rockefeller University
- Rose Associates
- Rose's Stores Inc.
- Roxbury Capital Management
- Roytex, Inc.
- RPS, Inc.
- R.S. Lauder, Gaspar & Co., LP
- Rudin Management
- Sanofi
- S.C. Johnson & Son, Inc.
- Schein Pharmaceutical, Inc.
- Schlumberger Industries, Inc.
- Scholastic Inc.
- Scitex Corporation Ltd.
- Seoul Bank
- 754 Fifth Avenue Associates LP.
- Sheffield Steel Corporation
- Shinhan Bank
- Simon & Schuster, Inc.
- Solomon R. Guggenheim Museum
- ✓ Sotheby's, Inc.
- Spencer Trask Securities Inc.
- SPP Hambro Securities
- St. Luke's-Roosevelt Medical Center
- Stamford Hotels Corporation
- Starrett Housing Corporation
- State University of New York
- Strausman Construction Co., L.P.
- Subaru Distributors Corp.
- Sunglass Hut International, Inc.
- Sun Life Insurance Co. of America
- Super-Sol Ltd.
- Superior TeleCom Inc.
- Swissôtel
- Tanker Service Committee
- Teachers Insurance & Annuity Association of America
- The Official Information Company
- Theatre Porters and Cleaners Funds
- Theatre Stagehands Funds
- Theatre Ticketsellers Funds
- Theatre Ushers Funds
- Thomson-Leeds Company, Inc.
- ✓ Time Warner Inc.
- Times Square Business Improvement District Committee
- ✓ Tony Award Productions
- Toshiba America Electronic Components, Inc.
- Total Fina
- Towers Perrin
- Trader Horn
- Trans World Airlines, Inc.
- Triborough Bridge & Tunnel Authority
- Trism, Inc.
- True North
- ✓ The Trump Organization



PROSKAUER ROSE LLP

- Trustee of Allegheny Health, Education and Research Foundation
- Tullett & Tokyo, Inc.
- Shania Twain
- 24/7 Media Inc.
- UUPCW Local 1262 Pension, Welfare and Legal Funds
- UIS, Inc.
- Ulano Corporation
- Underwriters Laboratories, Inc.
- Unilever United States Inc.
- Union Theological Seminary
- United Bank of Switzerland
- United Industrial Syndicate
- United Parcel Service, Inc.
- United States Surgical Corp.
- Universal Music
- US JVC Corp.
- U.S. News & World Report
- U.S. Realty Advisors
- U.S. Trust Co. of New York
- U.S. Trust Company of Florida
- USA Networks, Inc.
- Value Line, Inc.
- Values.com LLP
- Veronis, Suhler & Associates
- Vetco Inc.
- Visiting Nurse Service
- VS&A Communications Partners
- Warburg Dillon Read
- Warner Bros.
- Webco Industries, Inc.
- Weber Aircraft
- Western Pacific Housing
- Westholm Partners
- Wexford Management LLC
- Wilshire Real Estate Investment Inc.
- Winterland Productions
- WNBA
- C.K. Witco Corporation
- W.R. Huff Asset Management Co.
- Yamaichi International (America)
- Yellow Book USA, LP.
- The Zomba Group
- Zomba Group of Companies
- Zurich Capital Markets

PROSK0458



OCTOBER 1999 NEW BUSINESS COMMITTEE CHECKLIST⁴⁸

NEW BUSINESS COMMITTEE Page 1 of 8

Request: 9612

NEW BUSINESS COMMITTEE
Checklist

TO: The Attorney completing this form (i.e.: The Originating Attorney or the Attorney responsible for the Relationship with this Prospective Client):

Wheeler, Christopher C.
enter your name on this line

FROM: The Business Committee

Please complete this checklist, including as much detail as possible. When you have done so, please give it to your secretary for processing. Read carefully the form (s)he returns to you, as the processing of the information you provide on this checklist will generate affirmative statements on the resulting form, for which you will be responsible. When you are satisfied that the resulting form (not this checklist) is accurate and complete, submit the form electronically. After submitting the form, you will receive an email with the new New Business Checklist as an attachment. Review the attachment for accuracy, then forward it to the New Business Committee (email address: NBC) or your Department Chair. The first line of the attachment will alert you when Department Chair approval is required.

**** Request screen ****

Client Number (if existing Client): 40017-~~DK~~ 020

Client Name (if prospective Client): IVIEWIT LLC

Client Type:

Estate.....	_____
Foundation.....	_____
Governmental.....	_____
Individual(s).....	_____
Not-For-Profit.....	_____
Privately Held.....	<u>X</u>
Publicly Held.....	_____
Trust.....	_____

Nature of Client's Business: software

<http://proskaueratwork/newBuss/GenHtml/TempMain53369280.htm> 10/5/99

24 11:58 AM

Chris
For your
Review.
Submitted
NBC
10-5-99
10-5-99
To Mercedes
10-6-99

OK

⁴⁸ The Company has no knowledge that this document was ever formally submitted within Proskauer; the Company requests First Judicial Department Disciplinary Committee to obtain a true copy of this document/



**** Matter screen ****

Nature and scope of the matter: Patent/General

Has a formal "Conflict-Of-Interest" search been conducted by the Records Department? Yes (X) No ()

If "Yes," skip to the next question.

If "No," please explain:

If this matter is a litigation, will our client be the plaintiff? Yes () No (X)

Does this litigation involve a claim by an employee or former employee against an employer or former employer? Yes () No (X)

If this matter is a transaction, will it involve a closing? Yes () No (X)

Department primarily handling this matter:

- Corporate (X)
Health Care
Labor
Litigation
Personal Planning
Real Estate
Tax

Practice Area primarily handling this matter:

- Antitrust
Banking
Bankruptcy
Corporate (X)
Employee Benefits
Entertainment
Environmental
Health Care
Immigration
Intellectual Property
Labor
Litigation

24 11 58 AM



Personal Planning _____
 Real Estate _____
 Sports _____
 Tax _____

Office primarily handling this matter:

Boca Raton _____
 Los Angeles _____
 New York _____
 New Jersey _____
 Paris _____
 Washington _____

**** Attorneys screen ****

Originating Attorney(s) :Gortz, Albert W.
 Relationship Attorney(s) :Gortz, Albert W., Wheeler, Christopher C.
 Primary Relationship Attorney :
 Alternate Attorney(s) :
 Responsible Attorney :Gortz, Albert W.
 Assisting Attorney(s) :Wheeler, Christopher C.

**** Conflicts screen ****

Client Affiliates :iViewit LLC
 Potential "Adverse" Parties :N/A
 Opposing Counsel :

Will the Client be asked to execute a conflict waiver? Yes () No ()

The various types of conflict waivers are set forth in the form engagement letter (Document #687711, NYLIB1).

If "No," skip to the next screen.

If "Yes," what kind of conflict waiver?

General advance conflict waiver _____
 Specific conflict waiver _____

2011:58AM



**** Billing 1 screen ****

Billing Address Level:

Client Level (All matters for this client will be billed to this address) ... _____
Matter Level (Use this billing address for this new matter only) _____

Billing Address:

Address: 2255 Glades Road, Suite 337W Boca Raton,
FL 33431
City: BOCA RATON
State: FL
Zip: 33432-6080
Phone Number: BUSINESS*800-519-0234
Fax Number:
E-Mail:
Billing Contact Name & Title: Brian G. Uhley

**** Billing 2 screen ****

What is the expected fee range if this matter is handled to its anticipated conclusion?

- Pro Bono / Accommodation..... _____
- Up to \$5,000 _____
- \$ 5,000 - \$ 25,000
- \$ 25,000 - \$ 50,000 _____
- \$ 50,000 - \$ 100,000 _____
- \$ 100,000 - \$ 250,000 _____
- \$ 250,000 - \$ 500,000 _____
- \$ 500,000 - \$1,000,000 _____
- Over \$1,000,000 _____

Will the Client be billed on a MONTHLY basis for fees and disbursements, with payment to be made by the Client 30 to 60 days after submission of bills? Yes () No ()

If "Yes," skip to the next screen.

If "No," please indicate the billing frequency type below with an explanation as to why billing is not monthly (approval of your Department Chair and the New Business Committee will be required):

11/18 AM



- Bi-Monthly
- Quarterly
- Conclusion
- Other

Please explain:

**** Billing 3 screen ****

Will the Client be billed at our "Standard" Rates? Yes () No ()

If "Yes," skip to the next question.

If "No," please indicate the billing rate type below with an explanation as to why billing is not "Standard" (approval of your Department Chair and the New Business Committee will be required):

- Accommodation In-House
- Accommodation Outside
- Blended
- Capped
- Contingent
- Discount - 10%
- Discount - 15%
- Discount - 20%
- Discount - Disbursements only
- Discount - Misc
- Discount - Other
- Discount - Volume
- Discount - W/Potential Premium
- Fiduciary Commissions
- Fixed
- Premium
- Pro Bono
- Reduced

Please explain:

Have you submitted an estimate or budget to the Client which may be viewed as a "fee cap" or "limitation" on the amount the Client will be required to pay? Approval of your Department Chair and the New Business Committee will be required. Yes () No ()

If "Yes," please explain:

2/25/99 11:55 AM



**** Billing 4 screen ****

Will there be an initial retainer?

Yes () No (X)

The various types of retainer arrangements are set forth in the form engagement letter (Document #687711, NVLIBI).

If "Yes," how much: \$0.00 which constitutes

- An advance payment for services rendered _____
- An advance payment for the life of the relationship (Evergreen retainer) _____
- A fixed fee for specified service _____
- An availability retainer _____

If "No," why not? Existing, ongoing client

Firm policy requires that all new clients execute an engagement letter prior to our beginning work. Will there be an engagement letter? Yes () No (X)

If "Yes," please submit a copy (with client's signature) to the New York Office Records Department as soon as possible, and skip to the next screen.

If "No," please explain: Existing, ongoing client

**** Billing 5 screen ****

Do you have knowledge of the Prospective Client's financial condition? Yes (X) No ()

Are you satisfied that the Prospective Client has the financial ability to pay for fees and disbursements on a 30-or 60-day basis? Yes (X) No ()

Are you aware of any problems the Prospective Client has had in paying for legal services in the past? Yes () No (X)

If "No," skip to the next question.

If "Yes," please explain:

Have this Client and all related Clients regularly paid their bills within 60 days of submission? Yes (X) No ()

If "Yes," skip to the next question.



If "No," please explain:

Have we had to write bills down after their submission to this Client or to any related Clients?

Yes () No (X)

If "No," skip to the next question.

If "Yes," please explain:

Are there outstanding unbilled time charges or disbursements more than 60 days old for this Client or for any related Clients?

Yes () No (X)

If "No," skip to the next question.

If "Yes," please explain:

**** Billing 6 screen ****

Is a third party or group of Prospective Clients going to be responsible for the payment of all or part of the fees and disbursements?

Yes () No (X)

If "No," skip to the Referral screen.

If "Yes," answer all three remaining questions in this screen.

Who is the third party or group of Prospective Clients?

Please explain the billing and payment arrangement:

Are you satisfied that the third party or group of Prospective Clients has the financial ability to pay the bills?

Yes () No ()

**** Referral screen ****

Has this new matter been referred to us by a third party?

Yes () No (X)

If "No" skip the remaining questions.

If "Yes," answer the remaining questions.

Please check the appropriate firm type for the third-party firm:

24 11:59 AM



- Accounting Firm.....
- Actuarial and Other Consulting Firm.....
- Bank, Trust Co., Custodians, Etc.....
- Commercial or Residential R. E. Broker.....
- Financial Planners or Stock Broker.....
- Insurance Companies and Brokers.....
- Law Firm.....
- Public Relations.....
- Other.....

Referring Firm information:

Firm Name:
 Address:
 City:
 State:
 Zip:
 Phone Number:
 Fax Number:
 E-Mail:
 Referral Name & Title:

24 11:59 AM



EXHIBIT G



EMAIL OF MR. UTLEY NAMING RESPONDENT AS ADVISOR

-----Original Message-----

From: Brian G. Utley [mailto:brian@iviewit.com]

Sent: [Wednesday, April 18, 2001 11:17 AM](#)

To: Eliot I. Bernstein; 'simon@adelphia.net'; 'kanderson@myCFO.com'; 'dg_kane@msn.com'; 'glewin@goldsteinlewin.com'; 'hankpow@gate.net'; 'bprolow@tiedemannfunds.com'; Maurice Buchsbaum

Cc: 'Christopher C. Wheeler (E-mail)'

Subject: RE: Minutes of the Board Meeting of April 14, 2001

I was advised by Proskauer Rose that anyone who was in an active due diligence stage and who was review our intellectual property as part of that due diligence should receive a copy of the examiners opinion. Theref the opinion was forwarded to the same people who have received copies of the patent filings namely, Warner Brothers and Irell & Manella. [Ken Rubenstein, as our advisor, was also copied.](#) Your father suggested that, because of the importance of our intellectual property, our own Board of Directors should be aware of the cur status of our applications. With respect to Irell & Manella, it is quite likely that we will need to engage them or some other alternative counsel in order to respond to the opinion. I have a copy of Alvear's book if you need

With respect to processing the requested demo tape, you may recall that you actually set the standard by processing similar demo material for igallery some time ago. This job was handled discreetly and the 18 yea employee referred to had already been released from the business. We are not in the business of processin adult entertainment material and have consistently represented this position.

I trust this clarifies both matters.

Brian

-----Original Message-----

From: Eliot I. Bernstein

Sent: Tuesday, April 17, 2001 7:07 PM

To: 'simon@adelphia.net'; 'kanderson@myCFO.com'; 'dg_kane@msn.com'; 'glewin@goldsteinlewin.c
'hankpow@gate.net'; 'bprolow@tiedemannfunds.com'; Maurice Buchsbaum

Cc: Brian G. Utley; Christopher C. Wheeler (E-mail)

Subject: RE: Minutes of the Board Meeting of April 14, 2001

Brian - several board members asked that you specify which of our attorneys advised you and on wh legal references you were cited to disseminate the PCT report. Also, was there some reason that yo have recently decided to share patent news of any nature with those involved, prior you had never disclosed to the Board or potential clients anything that was regarding the patents?

I had already discussed with David the examiners report and we had begun to research the referenc Jose Alveraz's book, it does not look particularly relevant to our process.

Also, I find it in poor taste that you are encoding pornography with a 17 year old girl present in the ro; this could potentially be a risk to the company, so I ask that all further business relating to pornograp handled outside the office and without iviewit personnel or equipment. Could you please have our attorney's advise on the risks you may be subjecting us to in this matter. These matters were broug my attention by several of our employees who were offended.

Best,
Eliot



-----Original Message-----

From: Bonnie M Barwick

Sent: Tuesday, April 17, 2001 5:18 PM

To: 'simon@adelphia.net'; Eliot I. Bernstein; 'kanderson@myCFO.com'; 'dg_kane@msn.com'; 'glewin@goldsteinlewin.com'; 'hankpow@gate.net'; 'bprolow@tiedemannfunds.com'; Maurice Buchsbaum

Cc: Brian G. Utley

Subject: Minutes of the Board Meeting of April 14, 2001



www.iviewit.com

Dear Sirs,

As requested by Brian Utley please find attached a copy of the Minutes of the iviewit Holdings Inc. Board of Directors meeting of April 14, 2001. A hard copy of these minutes as well as a copy of the Patent Cooperation Treaty numbers PCT/US00/15405 and PCT/US00/15406 will follow by mail.

Bonnie M. Barwick

Office Manager/Executive Assistant
2255 Glades Road
One Boca Place-Suite 337W
Boca Raton, Florida 33431
Voice: 561-999-8899 extn. 302
Fax: 561-999-8810
Toll Free: 877-484-8444
email: bonnie@iviewit.com



WACHOVIA SECURITIES PRIVATE PLACEMENT MEMORANDUM NAMING RESPONDENT AS COMPANY COUNSEL



CONFIDENTIAL

Company has retained Foley & Lardner to shepherd its patent development and procurement. In addition, the Company has retained Kenneth Rubenstein of Proskauer Rose, LLP to oversee its entire patent portfolio – Mr. Rubenstein is the head of the MPEG-2 patent pool.

iviewit has assembled a complementary and seasoned, management team with executive rank, Fortune 100 and early-stage, entrepreneurial experience. The Company has retained Korn / Ferry to assist in the identification and recruitment of a high impact Chief Executive Officer (preferably from the media or entertainment industry) and an experienced Chief Technical Officer.

Since its June 1999 inception, the Company has raised over \$4.3 million of venture capital from Crossbow Ventures, Huizenga Holdings, and individual investors.

Technology Overview

iviewit's suite of video and imaging technology processes work across all industry platforms.

Imaging:

iviewit's imaging process is an enabling technology that creates an unparalleled, content-rich, viewing experience. Significant advantages of iviewit's imaging process include the following:

- Photo-quality Internet images
- Resistance to pixelation even at 30+:1 magnification (note: depending upon the material and the desired magnification)
- Full-screen and panoramic viewing up to 360°
- Consistent quality regardless of the end-user's Internet connection
- File sizes of 30Kb to 700 Kb for full panorama

Video:

The Company's video technologies allow high quality video streaming in the 150-300 Kbps range, providing better product and price performance for the product delivered and a significantly improved results in the 28-150 Kbps range. Below is a chart comparing iviewit's video capability to current industry levels:

<u>Bandwidth Range</u>	<u>iviewit Frame Rate</u>	<u>Industry Typical Frame Rate</u>
28-56 Kbps	8-15 frames/sec.	4-8 frames/sec.
56-150 Kbps	15-30 fps	12-20 fps
150-300 Kbps	30 fps	12-24 fps

The iviewit video technology is a highly scalable process costing approximately \$1.50/min of encoded video. The resulting files are ~25% less than comparable quality files. iviewit's 220Kps streams are equivalent to competition 300Kbps streams.

Business Strategy

iviewit intends to serve as an end-to-end applications solutions provider incorporating iviewit's proprietary imaging and or video technologies as well as a full-service image and video encoding, hosting and serving provider. iviewit licenses its imaging solutions to B2B and B2C clients in the auction, collectibles, and retail space with subsequent marketing into the healthcare and medical markets. iviewit is also structuring OEM and re-seller relationships to bundle the imaging software and processes with existing hardware including: digital cameras, scanners, and PCs. iviewit is structuring video license agreements with major content and broadband access providers to incorporate the iviewit process into video encoding solutions for direct internet streaming.

iviewit technologies are "process technologies" with pending patents based on efficiency equations, and many of the applications for these technologies are just now being recognized.



WACHOVIA SECURITIES PRIVATE PLACEMENT MEMORANDUM NAMING RESPONDENT AS ADVISORY BOARD MEMBER

CONFIDENTIAL

Investment Management, both based in London. Among his primary areas of expertise are technology research and economic research, including electronics, telecommunications and computer software. Most recently, he was Senior Technology Analyst and Vice President of Southeast Research Partners, Inc. where he worked with leading technology companies. He earned a bachelor of arts degree at Yale University and a master of business administration degree at Stanford University.

Advisors

Alan J. Epstein

Partner, Armstrong Hirsch Jackoway Tyerman & Wertheimer, P.C.

Mr. Epstein's law practice consists of advising Internet companies on various issues pertaining to the entertainment and sports industries, including the creation, licensing and acquisition of content, the introduction and negotiation of strategic partner relationships, and various other matters relating to the convergence of technology and content. Mr. Epstein also advises his firm's numerous celebrity clients on the exploitation and protection of their name and likeness rights and content on the Internet, as well as merchandising, endorsement and sponsorship deals. Prior to entering the UCLA School of Law, Mr. Epstein was a certified public accountant at Deloitte Haskins & Sells in Dallas, Texas.

Kenneth Rubenstein

Partner, Proskauer Rose LLP

Mr. Rubenstein is a partner at Proskauer Rose LLP law firm and is the patent attorney for iViewit. He is a registered patent attorney before the U.S. Patent & Trademark Office. Mr. Rubenstein counsels his clients with respect to the validity and infringement of competitors' patents, as well as prosecutes patent applications. For the past several years he has worked on the formation of a patent pool, for MPEG-2 technology, involving large consumer electronics and entertainment companies. He is also a former member of the legal staff at Bell Laboratories. Mr. Rubenstein received his law degree, cum laude, from New York Law School, and his Ph.D. in physics from the Massachusetts Institute of Technology where he also graduated with a B.S. Degree.

Christopher C. Wheeler

Partner, Proskauer Rose LLP

Mr. Wheeler is a member of Proskauer Rose LLP's Corporate Department and as a partner in the Florida office has a versatile transactional practice. He has had extensive experience in real estate and corporate law, institutional lending and workouts, administrative law and industrial revenue bond financing. Moreover, he serves as a strategist and counselor to many clients in handling their other legal and business matters. Mr. Wheeler is well-versed in general corporate law as well as mergers and acquisitions and securities matters. He has guided companies from startup through initial private placements to public offerings. A graduate of Hamilton College and Cornell Law School, Mr. Wheeler was a member of the managing Board of Editor of the Cornell Law Review.

Legal & Accounting Counsel

Arthur Andersen, LLP

Arthur Andersen's vision is to be the partner for success in the New Economy. The firm helps clients find new ways to create, manage and measure value in the rapidly changing global economy. With world-class skills in assurance, tax, consulting and corporate finance, Arthur Andersen has more than 70,000 people in 83 countries that are united by a single worldwide operating structure that fosters inventiveness, knowledge sharing and a focus on client success. Since its beginning in 1913, Arthur Andersen has realized 86 years of uninterrupted growth, with 1999 revenues over \$7 billion. Arthur Andersen is a business unit of Andersen Worldwide.

Proskauer Rose, LLP

This law firm is one of the nation's largest law firms, providing a wide variety of legal services to major corporations and other clients through the United States and around the



LETTER OF ALAN J. EPSTEIN, PARTNER OF ARMSTRONG HIRSCH
JACKOWAY TYERMAN & WERTHEIMER, LOS ANGELES, CAL.

May 19, 2000

VIA MESSENGER

Mr. Gregg W. Ritchie
Pacific Capital Group, Inc.
360 N. Crescent Drive
Beverly Hills, CA 90210

Re: iviewit.com

Dear Gregg:

I very much enjoyed meeting you for lunch earlier this week. As promised, enclosed is a copy of the Business Plan for our client, iviewit.com.

Iviewit has developed two proprietary and complimentary technologies to enhance video and images delivered on the internet. The first is a state-of-the-art technology which enables full-screen, full-frame rate (i.e., 30 frames per second) streaming video to be viewed by any internet video player at bandwidths as low as 150 kbps, with increased quality and reduced file size. The second digital imaging technology creates an opportunity for full screen still images and 360° panoramic views that can be magnified with minimal image distortion.

Iviewit has protected its technologies by filing and securing eight patent pending applications, and is currently buffering and expanding those patents through a significant supplemental filing. Iviewit is represented by several of the most prominent patent law firms and attorneys in the world. Bill Dick, who is the head of the intellectual property department of Foley & Lardner in Milwaukee, Wisconsin, was formerly in charge of IBM's foreign patent division. Mr. Dick and his patent team of attorneys are preparing all of iviewit's supplemental patent filings and are drafting all of iviewit's license agreements. Iviewit's potential patent litigation (if any) will be handled by Ken Rubenstein, who is the head of intellectual property litigation group at the law firm of Proskauer Rose in New York City. Mr. Rubenstein is in charge of all patent litigation on behalf of the MPEG patent pool, in addition to a number of other high-profile technology litigation matters.



Mr. Gregg W. Ritchie
May 19, 2000
Page 2

Iviewit has licensed its technology and providing services to a number of substantial clients, such as hollywood.com, broadway.com, Hyatt Hotels and Resorts, and Great Expectations Dating Service. Iviewit also is in final negotiations to license its technology to playboy.com, medicalonline.com (x-rays, MRI's CT-scans, etc.) americanenterprise.com (multi-hour surgical and educational videos), gregmanningauctions.com (one of the largest auction houses) and many other clients in the entertainment, health care, automotive and other industries.

Iviewit initially raised \$500,000 of seed capital from Wayne Huizenga's venture group (at a \$10 million post-money value). Within the last few months, Iviewit raised \$1.5 million in a Series A round at a \$25 million post-money valuation from an investment group led by several individuals who previously ran Merrill Lynch's venture division. Iviewit is currently seeking an additional \$1-\$2 million in the Series A round, with a Series B round (\$10 million minimum) to follow later this year. The proceeds will be used to provide working capital (including the leasing/purchase of equipment and facilities) which will enable iviewit to fulfill its substantial backlog of orders and to expand its licensing operations. Iviewit is currently in discussions with several of the nation's leading investment banks to lead the Series B fundraising efforts.

The iviewit technology is most easily explained through a demonstration. If Pacific Capital or its Venture Group are interested in learning more about the company, please let me know and I will arrange to have the principals fly to Los Angeles for a meeting. Although you can see some of the company's technology and applications on the website (www.iviewit.com), the highest-quality work is not available for public viewing and is best seen through a private demonstration.

I look forward to hearing from you.

Best regards.

Very truly yours,

Alan J. Epstein



EXHIBIT H



COMPANY S VIDEO TECHNOLOGY SPECIFICATION

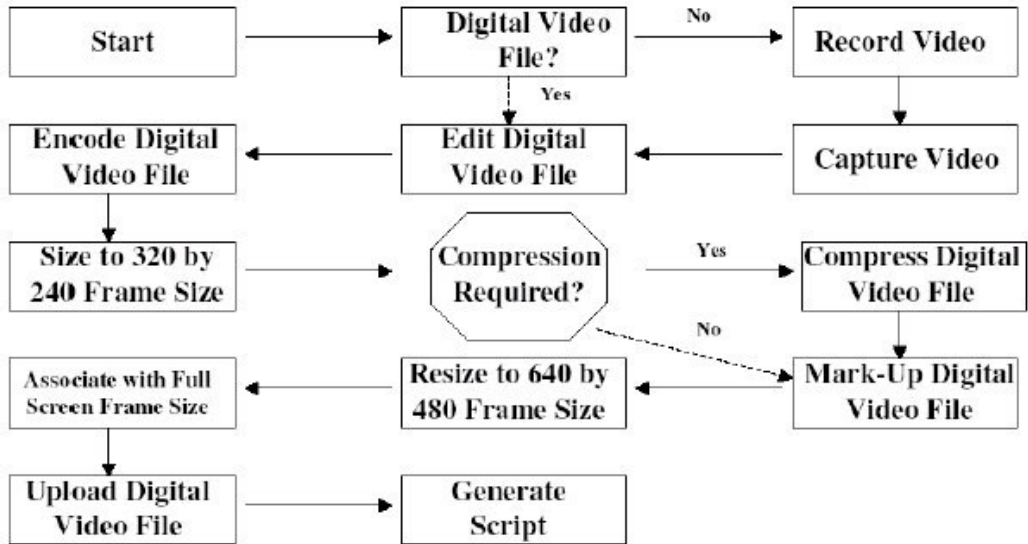



RESPONDENT AND MR. WHEELER S SUBMISSION OF VIDEO DISCLOSURE TO MR. JOAO

PROSKAUER ROSE LLP

2255 Greco Road
Suite 340 West
Boca Raton, FL 33431-7360
Telephone 561.241.7400
Facsimile in Florida
432.7749
Fax 561.241.7145

NEW YORK
LOS ANGELES
WASHINGTON DC
CLIFTON NJ
PARIS

PERSONAL AND CONFIDENTIAL

Fax Transmittal

Date June 1, 1999 Client-Matter 0894/40017/001

Total Pages (including Cover) 2
From Christopher C. Wheeler
Sender's Voice Number 561.995.4702

Sender's Room Number
Main Fax Operator 561.241.7400

To Ray Joao
Company Meltzer, Lippe

Fax No. 516.747.9363
Voice No. 516.747.0300.x240

Message

The attached is from Eliot Bernstein.

EB
561-47-4470

2025
B.W.I
35.6

Confidentiality Note: This message is confidential and intended only for the use of the addressee(s) named above. If it may contain legally privileged material, dissemination, distribution or copying of this message, other than by such addressee(s), is strictly prohibited. If you have received this message in error, please immediately notify us by telephone and return the original to us at the address above. We will reimburse you for the cost of the telephone call and postage. Thank you.

0894/40017-001 06/01/99 01:07 PM 12743

06/01/99 01:07 PM 12743



PATENT FOR VIDEO TECHNOLOGY

- > Step 1. Is to record the video under any format, beta, VHS, digital, any of the standard file formats. *VHS, digital, beta, VHS, digital - to edit, Live Motion.*
 - > Step 2. After the video is shot, the second step is to capture the video using any capture device and capture software. *Adobe Premier ~~PRO~~ VERSION 5.1 or Real Producer. 5.2*
 - > Step 3. Is to edit the video, if necessary, using any standard video editing tools. *Final Cut Pro*
 - > Step 4. Is to convert to real video format. *or Real Producer. 5.2*
 - > Step 5. Then we manually set the size of the video within the HTML code to 640 by 480. *Frame*
 - > Step 6. We then post to the Web using any Web FTP software. *WS FTP 4.00 or Ezy 2.00*
 - > Step 7. We then write an Ascii file that calls the real video to stream. This makes it a streaming real at full screen with very good clarity and quality. Under Step 7 we write a separate script saved as our *.rm (star.rm) file that will call the original real video file. This script is included in the HTML codes. For MPEG videos, we follow Steps 1 through 3 the same, then we, in Step 4, convert, if not already, to the MPEG format. 5, insert the video in the HTML codes and expand to 540 by 480. Then we upload the video file to the Web in Step 6. Step 7, this MPEG file is played from the Web by first downloading a small portion of the file and played through the necessary player or any player, actually, that supports AVI, MPEG-type video formats. *900 x 600, 1024 x 768, 1280 x 1024, 1600 x 1200*
- This tape was recorded on 6/1/99 at the law firm of Proskauer Rose LLP. *Proskauer Rose LLP*

0894.40017-001 BR/LB/231287 v1

06/01/99 12:35 PM (2/43)

** TOTAL PAGE: 82 **



PROVISIONAL PATENT FILING 60/137,207 BY MR. JOAO UNDER SUPERVISION OF RESPONDENT AND IN CONJUNCTION WITH MR. WHEELER

PTO 5057 (Rev. 5-85)

PROVISIONAL APPLICATION FILING RECEIPT



UNITED STATES DEPARTMENT OF COMMERCE Patent and Trademark Office ASSISTANT SECRETARY AND COMMISSIONER OF PATENTS AND TRADEMARKS Washington, D.C. 20231

APPLICATION NUMBER	FILING DATE	PL. FEE REC'D	ATTORNEY DOCKET NO.	DRWGS
60/137,297	06/03/99	\$75.00	5865-3	0

RAYMOND A JOAO MELTZER LIPPE GOLDSTEIN & SCHLISSEL PC 190 WILLIS AVENUE MINEOLA NY 11501

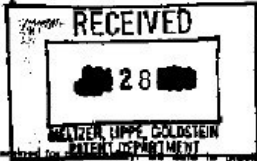

Receipt is acknowledged of this Provisional Application. This Provisional Application will not be considered for publication... Receipt is not to be subject to revival to restore it in pending status beyond a date which is after twelve (12) months from its filing date.

Applicant(s) ELIOT BERNSTEIN, BOCA RATON, FL.

IF REQUIRED, FOREIGN FILING LICENSE GRANTED 06/22/99 ** SMALL ENTITY ** TITLE APPARATUS AND METHOD FOR PRODUCING ENHANCED VIDEO IMAGES



Attorney Docket No. 5865-3

**APPARATUS AND METHOD FOR PRODUCING
ENHANCED VIDEO IMAGES**

The present invention is directed to an apparatus and a method for producing enhanced video images. A preferred embodiment of the invention is described in the following manner.

- Step 1. Record the video under any format, i.e., beta, VHS, digital, and/or any of the standard file formats, including, but not limited to, *.AVI, *.MOV, *.MPEG, etc., by utilizing an appropriate recording device such as a video camera, a film camera, a reel-to-reel recording device, and/or a live video recording device.
- Step 2. After the video is shot, the second step is to capture the video using any capture device such as a capture card or capture hardware, such as provided by Dazzle, and also by using capture software such as Adobe Premier version 5.1 or Real Producer G2.
- Step 3. Edit the video, if necessary, by using any standard video editing tools, such as, for example, Adobe Premier 5.1.
- Step 4. Convert the data and/or information obtained to a real video format such as, but not limited to, a *.RM format.
- Step 5. Manually set the size of the video within the HTML code to a 640 x 480 frame resolution, or any other suitable resolution, such as, but not limited to, 800 x 600, 1024 x 768, 1280 x 1024, 1600 x 1200.
- Step 6. Post the obtained file to a Web page, Web site and/or to the Web, by using any Web FTP software, such as, but not limited to, WS FTP PRO.
- Step 7. Generate or write an ASCII file that calls the real video to stream. This results in streaming real video at full screen with very good clarity and quality. Under Step 7 a separate ASCII file is written and saved as an *.RPM file, or other suitable format, that will call the original real video file. This script is included in the HTML codes. For MPEG videos, Steps 1 through 3 are followed as described above. In Step 4, the file is converted, if not previously converted, to an MPEG format. Next, the video is inserted into the HTML codes and expanded to a 640 by 480 resolution, or higher resolution. Then the video file is uploaded to the Web page Web site, and/or the Web in Step 6. Thereafter, at Step 7, the MPEG file is played from the Web page, Web site and/or from the Web, by first downloading a small portion of the file and playing the file through a suitable player which supports AVI, MPEG-type, etc., video formats and/or other suitable formats.

P:\PUBLIC\PATENT\BERNSTER\5865-3.APP

HAND NOTES OF MR. UTLEY POINTING TO MISSING ELEMENTS OF MR. JOAO S PROVISIONAL FILING UNDER SUPERVISION OF RESPONDENT⁴⁹

516.747.0653

3/9/2000

Guidance
BIN 1 2 F101

Ray Joao

Ray, there are major missing items in docket's 1 + 6:

1. Claims do not reference stitching
2. Process is ammended as shown on the diagram
3. The relationships between the enhanced digital image and the zoom and pan function together with controls is not clear
4. The description and claims stop at the production and loading of the image.

5. Object model Brian

⁴⁹ Supra Note 45.



**TELECONFERENCE TRANSCRIPT OF
JULY 31, 2000
PARTICIPANTS:**

- **DOUGLAS BOEHM OF FOLEY AND LARDNER;**
- **MR. BERNSTEIN, SIMON L. BERNSTEIN, MR. UTLEY, AND MAURICE BUCHSBAUM OF THE COMPANY;**
- **MR. WHEELER OF PROSKAUER**



EXHIBIT I



**HAND NOTES OF MR. JOAO IN FILIPECK MEETING AT RESPONDENT S
OFFICE**

Proskauer 21st Floor

Steve Filipeck - Fish + Richardson

9/20/99

32mm → Wide angle lenses

image cameras

take out all specific software & hardware

magnification vs zooming

* Scan directly from the film w/ enlarger

JPEG file is always compressed
difference is that

if lowest compression is introduced virtually no

artifacts - as compression - you narrow

color compression - lose definition

* put in more detail on how the process works

#7 Video - straight through live connection to
camera through capture device & onto the web

** When you take/process a live capture or capture
from a record medium & process it, you may
take it or the processed & prepared form on
a computer storage medium which is streamable
processed & stored in deliverable form.

** Computer stores the processed videos &
stores it.

EV-
26



1/11/00

Conf / B. Utley - Wheeler

p.1

↳ Processes defined at site level
 based on tools - everything we use is
 public domain
 parameters are of such a nature - little
 if any + claim as patentable.

↳ Breached Confidentiality Agreement
 ↳ several steps had to go through to arrive at
 side rider b/c integrated into Dazzy card
 & Real player.

↳

1st patents pending have value

Bit 4
20.5
2026

2nd { head of 2 - complexity
 • Misapprop of trade secrets
 • establish a solid base of
 original claims.

show when where + how process
created

↳ process currently being employed in
 public domain already
 Capture + encode
 • Qui • evcode



-2

1/26/00 Conference with Brian Utley re copying of records.
Copies ~~will~~ will be forwarded to Brian today or
tomorrow. Spoke also future patents activities and
prospect of finding a strategic money partner (i.e.
Sony Pictures).

For IViewIT

Priskans

→ Needs description of each application

Gayle Coleman

561-995-4749

Fax 561-241-7145

email G Coleman@Priskans.com

- APPLICATE
- TITLE
- Serial No.

~~8:30~~

→ 4 @ 1 2
copy [unclear] 2 0/1
[unclear] → 2 1
→ 1 2



SCHEDULING OF THE FILIPECK MEETING

PROSKAUER ROSE LLP

2255 Glades Road
Suite 340 West
Boca Raton, FL 33431-7360
Telephone 561.241.7400
Elsewhere in Florida
800.432.7746
Fax 561.241.7145

NEW YORK
LOS ANGELES
WASHINGTON
NEWARK
PARIS

Form with fields: Date (September 17, 1999), Client-Matter (0894/40017/001), Total Pages, From (Gloria, for Christopher C. Wheeler), Sender's Voice Number (561.995.4702), To (Brian G. Utley), Company, Sender's Room Number, Main Fax Operator (561.241.7400), Fax No. (393.7458), Voice No. (750.6876)

Message

The two closest hotels with our special Proskauer rates are:

Renaissance Hotel (1/2 block from Proskauer offices)
714 Seventh Avenue
New York, NY 10036
212.765.7676 212.261.5151 (Fax)
Ask for Proskauer Rate

DoubleTree Guest Suites
1568 Broadway
New York, NY 10036
212.719.1600 212.345.5237 (Fax)
Ask for Proskauer Rate

Handwritten note: Conf # 837.137.11, 800 468 3571

The following Proskauer conference room details have been completed:

Conference Room 2100 (also called the Goetz Room);
21st Floor of our building located at 1585 Broadway;
Large room that holds 20;
Reserved for 8 AM until 10 AM, Tuesday, September 21, 1999;
A receptionist is right outside the conference room and she can help answer any questions,
the receptionist arrives at 8:30 AM;
Coffee, tea and ice water will be set up in the conference room at 7:30 AM;
The glass doors to the Proskauer office on the 21st floor are locked until 8:30. After you exit the
elevator, use the phone by the glass doors to call security to let you in.

Confidentiality Note: This message is confidential and intended only for the use of the addressee(s) named above. It may contain legally privileged material. Dissemination, distribution or copying of this message, other than by such addressee(s), is strictly prohibited. If you have received this message in error, please immediately notify us by telephone and return the original to us at the address above. We will reimburse you for the cost of the telephone call and postage. Thank you.

0894/40017-001 BRLIB1/241812 v1

09/17/99 04:49 PM (2743)



**HAND NOTES OF MR. WHEELER IN FILIPECK MEETING AT
RESPONDENT S OFFICE**

Notes
Meeting of Providence in NY

Ray + Bryan met at Tilipich -
copy of non-disclosure coming

Document 4.1
+ Document 1

5 + 6 are extensions -

Steve - "my concerns, issues" - very
uncomfortable with what I have read -

Bryan leaves

Ray says walked to train + no issues

Bryan calls Chris H. -

"inquiry OK"

"on video side - could not give
response to video question"

"did not feel comfortable with video -
- couldn't explain how it worked -
Steve taken aback by question -
they asked - "what is your view about
quality of video + how it works"
didn't get into how it works -

that is important and needs to be covered -

video involving - only recently -> document 7 is
not filed -> very important that we complete -

Wids

- old account didn't address -
- no attacks -
- they have investment in video - the new
- the same - we had it -

raise level of debate & motivation -

~~this is~~

high demand →

not as easy to explain how it works -

Video → more subject to attack

Ours is not related to compression techniques -

If inquiry case we return to 1st step -
→ we do not do that with video -

- Video side is more opaque -

Royalty free →



LETTER OF MR. COLTER RELYING ON RESPONDENT S OPINION

Subj:iviewit

Date:1/14/2002 9:51:08 PM Pacific Standard Time

From:David.Colter@warnerbros.com (DColter0264)

To:John.calkins@warnerbros.com

CC:CHuck.dages@warnerbros.com, Alan.Bell@warnerbros.com (ABell0648)

Sent on: AOL 6.0 for Windows US sub 10551

John,

In all the review we have done with iviewit it seems to boil down to the status of the patents and their inherent value. At that point it is a risk-reward evaluation -- without awarded patents it is difficult to completely assess the value. I would suggest that we consider one other perspective...

Prior to iviewit (approx Feb 2000) the video we (WB Online) delivered on the web was QCIF (160x120) or smaller and was below full frame rate. At the time of our first meeting we also identified On2 along with iviewit as two solid players who could deliver full screen full frame rate web video. All who saw it were impressed. Greg and I visited iviewit in August and reported back that they had filed patents on scaling techniques that hinged upon a visual 'trick' which allowed the human eye to accept 320x240 video scaled to 640x480 at 30 fps as close to VHS quality. We checked with Ken Rubenstein and others who provided some solid support for iviewit, and Chris Cookson asked Greg and I to continue to work with iviewit in an R&D capacity.

In the fall of 2000 iviewit also met with a number of folks at WB Online (in September and October) and demonstrated their process and techniques to Sam Smith, Houston, Joe Annino and others. Sam contacted iviewit a number of times and requested the patents, along with specifics of the iviewit process to evaluate what they were doing. I was not part of these meetings, but was aware they had occurred, as Jack Scanlon kept me up to date.

When I sat down with Morgan and Houston in March 2001 to see what technology they were using to encode video, it was clear that they were using some of the techniques that would overlap with iviewit's filed process patents (still pending), but it is not clear that these were all learned from iviewit -- we may wish to explore this a little. This meeting was to determine what equipment we would get for our lab at 611 Brand. This same information was also provided to iviewit by Morgan as they were establishing the company as an outsourcing facility for encoding our content.

I am aware of several meetings held between iviewit and WB Online to share information of techniques and process, and was invited to a few of them.

We all signed iviewit's confidentiality agreement. So to the other perspective....

We have an opportunity to establish a license with iviewit for a modest fee at this time, and establish a MFN. In good faith we signed the confidentiality agreement, iviewit revealed their processes and techniques, and we now use those techniques in encoding. As we have discussed on a few occasions, these techniques now appear in the public domain to some extent in documentation for Real Producer, WMP Developer Guides, Media Cleaner Pro, etc, but they were not available in 2000. I would not suggest we learned the techniques completely from iviewit (I actually do not know the answer), but a modest licensing fee may be appropriate and honorable considering our good faith relationship in signing the confidentiality doc.

If we choose to pass at this time the risk is primarily from iviewit's main investor, Crossbow Ventures, gaining control of the IP and approaching WB later for a license -- I do not believe they will be as friendly considering their dealings with iviewit and it's employees since Feb of 2001. It is estimated that the patents will be completed in 8-12 months.



As you are all aware I have a personal relationship with Eliot Bernstein, the founder of iVIEWIT, and as a result, I left the evaluations and decisions to Greg, and others, and only assisted iVIEWIT to get to the correct people in WB and AOLTW. I wanted to add this perspective as we consider if there is an option to pursue with iVIEWIT -- they are facing continued financial pressure right now. There are many other threads to our interaction with iVIEWIT and I would be happy to discuss.

Thanx,
David



LETTER OF MR. WHEELER APPEALING TO PARTNERS

Dear Colleagues,

As a firm, we are in a unique position to impact the effectiveness of the Internet and to profit from the same. The firm of iviewit.com, Inc. is one of my clients and Proskauer, Rose, LLP. is a 2.5% shareholder. I have worked closely with iviewit, for the past 18 months, establishing and fine-tuning their corporate structure. My objective with this letter is to introduce you to this forward-thinking company and to ask for your support and assistance.

The Internet is quickly evolving from a text-based medium that users have been forced to read, into a multimedia platform that users can begin to *experience*. The importance that this evolution has to e-commerce has been likened to the impact felt by television when it was embraced as a marketing and communications tool. iviewit's intellectual property positions them as a leader in the streaming video, streaming audio and virtual imaging online markets. Their technologies have broad ranging applications for many different industries including: entertainment, auctions, education, healthcare and retail.

Because of the extensive applicability of iviewit's products, the vast majority of Proskauer's client relationships represent potential clients for iviewit. Please join me as I endeavor to introduce my clients to iviewit and, in the process, help those clients to gain a competitive advantage through the utilization of iviewit's technologies. Please contact me with any opportunities that you identify and I will arrange an introduction to a member of iviewit's management team. I have enclosed a descriptive flyer from iviewit and a multimedia CD-ROM that will serve as an introduction to iviewit. Additional information can be found at their website, www.iviewit.com.

Thank you for your time and attention. I look forward to working together to help this valued client and to further enhance the value of our equity position in iviewit.

Sincerely,

Christopher C. Wheeler



EXHIBIT J



**DEPOSITION OF RESPONDENT IN THAT CERTAIN LITIGATION
AVOIDING QUESTION ON MPEG LA, LLC**

2 Q. How about what is called the MPEG
3 Patent Pool, have you heard of that?

4 A. Yes, I have.

5 Q. why don't you tell me what that
6 is.

7 A. Decline to answer at this time.

8 Q. why do you decline to answer?

9 A. Irrelevant to this deposition.

10 Q. I'm sorry, irrelevancy is not an
11 objection that would allow you not to answer,
12 sir.

13 A. Make a motion to the judge. If he
14 orders me to tell you about it, I will tell
15 you.

16 MR. SELZ: Chris, are you
17 instructing your client not to answer?

18 MR. PRUSASKI: I am going to put
19 an question for relevancy based on the
20 court's granting of the motion and
21 limiting on the record, and if
22 Mr. Rubenstein declines to answer then
23 he is declining to answer.

24 And, just so I don't have to keep
25 objecting, Mr. Selz, to make this

1 Rubenstein
2 easier, my objection is continuing in
3 nature as to any questions regarding any
Page 11



4 transactions for IViewIt that you are
5 going to ask Mr. Rubenstein if he was
6 involved in based on the court's
7 granting of the motion and limiting.

8 MR. SELZ: Let me go on the record
9 and say the discovery documents that
10 have been produced by the Defendants --
11 Plaintiff in this matter indicate
12 various dealings in which Proskauer Rose
13 was affiliated including dealings with
14 H. Wayne Huizenga, CrossBow Ventures,
15 wachovia, a number of other entities
16 which are part of the discovery and have
17 been produced by the Plaintiffs pursuant
18 to a valid request for production, so to
19 the extent you are claiming it's subject
20 to any motion and limited, that's fine
21 with regard to the trial, and the
22 discovery you produced on your own
23 pursuant to a request for production
24 which has not been held invalid includes
25 these very matters.

14

1 Rubenstein

2 A. So why don't you tell me more
3 particularly what you want to know.

4 MR. PRUSASKI: Mr. Selz, let me
5 just respond to that.

6 There were never any affirmative
Page 12



7 defenses asserted by the Defendants in
8 this matter that have anything to do
9 with particular transactions, the
10 defenses involved whether the bills
11 were --

12 MR. SELZ: Let's go --

13 MR. PRUSASKI: I get to finish
14 because --

15 MR. SELZ: Go ahead and finish.

16 MR. PRUSASKI: Thank you.

17 There were never any affirmative
18 defenses asserted by the Defendants in
19 this matter relating to anything other
20 than the amount of the bills. And, so,
21 to the extent that the court granted our
22 motion limiting it, the Defendants can't
23 put any evidence of any particular
24 transactions or alleged wrongdoing by
25 Proskauer on at trial, but to that

15

1 Rubenstein
2 extent I am going to ask Mr. Rubenstein
3 to answer your questions. If I feel
4 that they are becoming overreaching, I
5 will make -- or if you are extending too
6 far into what I think is a violation of
7 the court's granting of the motion of
8 limiting, I will make another objection.

9 MR. SELZ: And let me go on the
Page 13



10 record, the motion of limiting is fine
11 with regard to anything presented at
12 trial. It certainly does not preclude
13 the scope of discovery from including,
14 in a deposition, questions which may
15 lead to discoverable evidence concerning
16 the bills and the services that were
17 provided, which is the basis for the
18 affirmative defenses.

19 MR. PRUSASKI: And I am aware that
20 you have some latitude with respect to
21 discovery under the rules.

22 MR. SELZ: And I think we have
23 pretty significant latitude under the
24 rules.

25 And with regard to your client,

]

16

1 Rubenstein
2 Mr. Rubenstein, indicating he is
3 refusing to answer, I believe you should
4 instruct him right now, under Florida
5 law, he doesn't have the right to refuse
6 to answer.

7 A. All right, I will answer the
8 question.

9 MR. PRUSASKI: I just said a
10 minute ago we will go ahead.

11 A. Anything you want to know about
12 the MPEGLA patent pool, that's public

Page 14



13 information, it's is on a web site,
14 MPEGLA.com. You should go look at that
15 web site. Any public information that I am
16 entitled to tell you is on that web site.
17 Q. well, I am going to ask you, sir,
18 in this deposition to give me that
19 information.
20 A. And I am just telling you to go
21 look at the web site.
22 MR. SELZ: Let the record show the
23 witness is refusing to respond to a
24 direct question.
25 A. That is an incorrect

17

1 Rubenstein
2 characterization of the record.
3 The record shows that I told you a
4 place where you can get the answer very
5 easily. There is no reason for you to make me
6 sit here and waste my time repeating to you
7 things you can easily read about.
8 Q. well, sir, this is your testimony
9 at your deposition.
10 A. That's right, which you are making
11 me do. I consider the deposition nothing but
12 harassment, considering that I had nothing to
13 do with the company. It's just a form of
14 harassment.
15 You go read the web site, if you
Page 15



16 want to know about it.

17 Q. Okay, so you are refusing to
18 answer?

19 A. I am not refusing.

20 Q. Other than advising me to go to a
21 web site --

22 A. I am not refusing to answer. I
23 did answer. Please stop characterizing my
24 testimony. I told you the answer. I told you
25 all publicly-available information about the

18

1 Rubenstein
2 MPEG patent pool can be found at
3 www.MPEGLA.com. You are free to go read it.
4 Please go read it and you will learn all you
5 need to know about it.

6 Q. So you are not going to tell me
7 what the "MPEG patent pool" is?

8 A. I told you you could go read it.

9 Q. Okay.

10 MR. SELZ: Chris, do you want to
11 instruct your witness, or deponent, or
12 client, at all in that matter?

13 MR. PRUSASKI: Do you have any
14 specific questions with respect to
15 IViewIt in the MPEG patent pool?

16 MR. SELZ: Yes.

17 A. All right, so why don't you ask me
18 those questions.

Page 16



19 MR. SELZ: I want Mr. Rubenstein
20 to first explain to me what the "MPEG
21 patent pool" is, and then I will ask him
22 questions concerning exactly how it
23 relates to IViewIt.

24 In other words --

25 A. Okay, I will answer both your

19

1 Rubenstein

2 questions.

3 Q. Go ahead.

4 A. The "MPEG patent pool" is a
5 collection of patents owned by a group of
6 companies related to the MPEG 2 video
7 compression standard and, as far as I know, it
8 has nothing whatsoever to do with IViewIt.

9 Q. So it has no technology -- the
10 MPEG patent pool uses no technology in any way
11 related to any of the IViewIt entities or
12 their intellectual properties; is that your
13 testimony?

14 A. No, it's not my testimony.

15 Q. Okay.

16 A. My testimony is, it's a group of
17 patents chosen according to very specific
18 criteria related to the MPEG 2 standard and,
19 to my knowledge, has nothing to do with
20 IViewIt.

21 And please do not characterize my
Page 17



22 words. Please do not rephrase them. If you
23 don't know what I said, you can ask the
24 reporter to read it back. But do not
25 characterize my testimony.

20

1 Rubenstein

2 MR. SELZ: Again, let the record
3 reflect the deponent is not being
4 responsive.

5 A. I am being very responsive.
6 Please stop characterizing my testimony. And
7 please stop putting things on the record that
8 are incorrect.

9 Q. Mr. Rubenstein, I am asking you
10 questions, and I am asking --

11 A. And you are not listening to the
12 answers very carefully, so -- I don't know how
13 much experience you have taking depositions --

14 MR. SELZ: Again, let the record
15 reflect that --

16 A. Stop interrupting my answers. Do
17 not interrupt me.

18 Q. Mr. --

19 A. Do not interrupt me.

20 Q. Mr. Rubenstein --

21 A. Let me finish.

22 Are you going to proceed to
23 continue to interrupt me or not?

24 Q. If you want to answer the
Page 18



25 questions, I have no problem.

21

1 Rubenstein

2 A. Look, I answered your questions.
3 You are unable to keep track of what I am
4 saying.

5 So, please, if you don't know what
6 I said, ask the reporter to read it back, but
7 please do not characterize my testimony in
8 your own words.

9 Q. Okay --

10 A. Just don't do it.

11 Q. what I am asking you is this. Do
12 any of the members of the MPEG patent pool use
13 any of the technologies of IViewIt?

14 A. I would have no idea.

15 Q. who is the person in charge of the
16 MPEG patent pool, sir?

17 A. Like I say, I advise you to check
18 their web site if you want to know information
19 about that patent pool.

20 Q. well, again --

21 A. It's not me.

22 Q. Are you involved with the MPEG
23 patent pool, sir?

24 A. Yes.

25 Q. what is your position --



1 Rubenstein
2 A. I am counsel to MPEG, LLC.
3 Q. Do you advise the MPEG patent pool
4 with regard to legal issues?
5 A. That's privileged information.
6 Q. Not whether or not you advised
7 them on legal issues.
8 A. You are asking me -- I am not
9 going to discuss with you anything about
10 anything I do with any other client in this
11 law firm.



EXHIBIT K



RESPONDENT POINTS TO HIS LACK OF LACK OF BILLINGS⁵⁰

A. Patent Work: Most of Mr. Bernstein's allegations derive from his claim that Mr. Rubenstein mishandled certain patent work. To the contrary, as we show below (see Section II), there is overwhelming testimonial and documentary evidence showing that this allegation is false. Approximately twenty Proskauer attorneys performed legal services for and billed time to Iviewit matters. Mr. Rubenstein wasn't one of them. Of the almost \$370,000 owed by Iviewit for legal services rendered by Proskauer, Mr. Rubenstein did not bill a minute of time to the engagement. Further, even ignoring Mr. Rubenstein's lack of involvement, no one else at

Proksauer performed patent work for Iviewit. Iviewit's patent work was handled entirely by patent attorneys at other law firms. Whether there were any errors or omissions with the patent work is immaterial. Proskauer simply did not perform that work.

⁵⁰ *Supra* Note 30 at 4.



**BILLINGS OF MR. WHEELER FROM PROSKAUER BOCA RATON, FLA.
OFFICE**

02/18/99 C WHEELER .25 Conf with Mr. Rubenstein

01/14/99 C WHEELER .50 Follow up on status on intellectual property review and new incorporation

01/28/99 A GORTZ .75 Ken Rubenstein call, cf call Eliot Bernstein & Ken Rubenstein, cf Mara Robbins re confidentiality agreement

02/01/99 C WHEELER .25 Conf as to status of intellectual property work

02/16/99 C WHEELER .25 Conf with Mr. Bernstein; call to Mr. Rubenstein

02/17/99 C WHEELER .25 Call to Mr. Rubenstein re patent advice; call with Ms. Coleman re financial advisor

02/18/99 C WHEELER .25 Conf with Mr. Rubenstein

03/16/99 M ROBBINS .50 Inter-office conference with Wheeler re: intellectual property matters.

03/29/99 K HEALY 1.25 Tc w/C. Wheeler; tcs w/Eliot Bernstein re intellectual property protections; tc w/Raymond Joao re patent pending; tcs w/E. Bernstein and Jerry Levin re license business models; review protectability of web-sites

03/31/99 K HEALY .25 Tc w/K. Rubenstein re Patent advice

04/22/99 K HEALY .25 Tc w/R. Joao; e-mail to E. Bernstein

05/12/99 C WHEELER 1.00 Conf with Messrs Bernstein and Lewin; call to R. Joao; transmittal of agreement

05/12/99 C WHEELER .50 Conf with Mr. Joao re stock ownership, subsidiary and patent protection

05/12/99 C WHEELER 2.00 Conf with Joao; meeting with Thompson to arrange for confid. agreements and generic agreements



05/20/99 C WHEELER .75 Conf with Mr. Joao

05/20/99 C WHEELER 2.00 Call to Mr. Lewin; conf with Ken Rubenstein;
conf with Mara Lerner; numerous conf with
Elliot Bernstein

05/20/99 C WHEELER 1.00 Conf with Mr. Joao

05/25/99 C WHEELER 11.00 Trip to Orlando for meeting with Real 3D
technology staff

05/26/99 C WHEELER 1.00 Review of patent; set up patent conference;
arrange follow up on shares;

05/27/99 C WHEELER .50 Conf with Mr. Rubenstein

05/27/99 C WHEELER 1.50 Overview of Iviewit patent matters and
corporate matters

05/28/99 C WHEELER .50 Confirmation on Joao meeting

05/28/99 C WHEELER 2.00 Meeting as to patent issues and management
matters

05/28/99 C WHEELER .50 Conf. w/K.Rubenstein

05/28/99 K HEALY .50 Tcs w/C. Wheeler re IP Issues; review web-site

05/31/99 C WHEELER 1.00 Review of patent and other materials

06/01/99 C WHEELER 4.00 Conf with Mr. Rubenstein; conf with Mr. Lewin;
conf with Mr. Healy; conf with Mr. Joao; conf
with Mr. Akselrod re patents, tax
ramifications, copyright work;

06/01/99 K HEALY 1.50 Conference call w/E. Bernstein, R. Joao, K.
Rubenstein, C. Wheeler, and others re iviewit
I.P. issues; review cd.rom

06/03/99 C WHEELER 2.00 Call to Mr. Joao; call to Mr. Healy; conf with
Mr. Bernstein; review of numerous
correspondence; conf with Mr. Lewin

06/04/99 C WHEELER 2.00 Prep of revised confidentiality agreement; call
to Ms. Bibona; conf with Mr. Joao;

06/11/99 C WHEELER .25 Call to R.Joao



06/16/99 C WHEELER 4.00 Meeting with Mr. Joao and Messrs. Bernstein re patent and other matters

06/23/99 S KAPP .50 Conf. with CCW regarding various matters pertaining to structure, patents, confidentiality agreements

06/18/99 C WHEELER 3.50 Review of patents with Mr. Joao; conf with Mr. Lewin re status; conf with Mr. Bernstein; Check of status of new corporate documents

06/23/99 S KAPP .50 Conf. with CCW regarding various matters pertaining to structure, patents, confidentiality agreements

07/28/99 C WHEELER 3.50 Conf with Mr. Lewin; conf with Mr. Buchsbaum; review of corporate status; conf with Mr. Thompson; review of corres. from Mr. Epstein; call to Mr. Joao; conf with Mr. Wilson; conf with Mr. Joao; call to Mr. Lewin

07/31/99 C WHEELER 1.50 Review and organization of various matters involving meetings, venture capital, patents and prospects

08/04/99 S KAPP .25 T/c with Ray Joao

09/09/99 K HEALY .50 Review files to prepare IP Materials for E. Bernstein and B. Utley

09/10/99 C WHEELER .25 Arrange for patents

09/10/99 C WHEELER 2.00 Conf with Mr. Brandon; conf with Mr. Brandon; conf with Mr. Rubenstein; transmittal of materials to Mr. Rubenstein; Call to Mr. Joao

09/13/99 C WHEELER 1.00 Conf with Mr. Brandon; conf with Mr. Joao;

09/13/99 J ZAMMAS 1.25 Discuss patents with C. Wheeler's secretary;

09/21/99 C WHEELER .25 Call to Mr. Utley re patent meeting

09/21/99 C WHEELER 1.00 Conf with Mr. Utley re patent meeting and status of negotiations; call to Mr. Brandon



09/22/99 J ZAMMAS 3.00 Work on patent binders and trademark binders for C. Wheeler; telephone Raymond Joao regarding all patents; compile all documents by shareholder/noteholder

09/23/99 J ZAMMAS .25 Telephone Raymond Joao regarding patents.

09/24/99 C WHEELER 1.00 Call on utilities; follow up on space requirements; conf on patent questions

09/24/99 J ZAMMAS .50 Update shareholder list; telephone Raymond Joao's secretary regarding patents; advise C. Wheeler.

09/27/99 J ZAMMAS 2.50 Revise consents to indicate that Brian Utley is elected as Chief Operating Officer of the three entities; telephone calls from Mr. Joao's office regarding patents; complete work on patent binders for C. Wheeler; send stock certificate of uview.com, Inc. to Patricia Daniels; send iviewit.com LLC subscription letters to James Armstrong, Andrew Dietz, Lisa Friedstein and James Osterling.

11/29/99 J ZAMMAS .25 Copy official filing receipts for two patents, insert in patent binders and give two copies to Brian Utley to insert in his binders.

01/11/00 C WHEELER 1.00 Conf with Mr. Bernstein re patents and infringement

01/11/00 C WHEELER 1.00 Conf with Mr. Joao re patents

01/11/00 C WHEELER .50 Conf with Mr. Lewin re patents

10/11/00 C WHEELER 1.50 Conf with Mr. Utley re Ken Rubenstein and Time Warner; conf with Mr. Rubenstein



**EXAMPLE OF PROSKAUER BILLING SUMMARY...WHERE IS
RESPONDENT IN LIGHT OF PRIOR BILLINGS**

CLIENT: IVIEWIT.COM, INC.
MATTER: GENERAL CORPORATE ADVICE
PAGE: 5

October 13, 2000

SUMMARY OF HOURS

NAME	HOURS
CHRISTOPHER C. WHEELER	12.25
RICHARD H. ROWE	.25
TOTAL FOR PARTNER	12.50
DONALD E. THOMPSON II	1.00
TOTAL FOR SENIOR COUNSEL	1.00
GAYLE COLEMAN	.25
MARA LERNER ROBBINS	10.00
SUSAN L. WIENER	1.00
TOTAL FOR ASSOCIATE	11.25
JILL B. ZAMMAS	2.75
TOTAL FOR LEGAL ASSISTANT	2.75
TOTAL HOURS:	27.50

DISBURSEMENTS AND CHARGES

DESCRIPTION:	AMOUNT
DELIVERY CHARGES	11.44
LONG DISTANCE TELEPHONE	1.85
REPRODUCTION	13.80
TOTAL DISBURSEMENTS AND CHARGES FOR THIS MATTER:	\$27.09



EXHIBIT L



THE FLORIDA BAR RESPONSE OF MR. WHEELER THAT NAMES WARNER BROS. A CLIENT OF RESPONDENT

II. Iviewit's Complaint Regarding Proskauer's Handling of Iviewit's Relationship with Warner Bros. Stems from Proskauer's Refusal to Place Itself in a Conflict of Interest Position

As is clearly demonstrated by Iviewit's latest submission, its real complaint regarding Warner Bros. is its contention that it has somehow been damaged because Mr. Rubenstein refused Iviewit's requests to vouch for Iviewit's technology to Warner Bros. (a Proskauer client) after Proskauer filed a



LETTER OF MR. COLTER CLAIMING OVERLAPPING OF MR. BERNSTEIN S TEACHINGS

Subj:iviewit
Date:1/14/2002 9:51:08 PM Pacific Standard Time
From:David.Colter@warnerbros.com (DColter0264)
To:John.calkins@warnerbros.com
CC:CHuck.dages@warnerbros.com, Alan.Bell@warnerbros.com (ABell0648)
Sent on: AOL 6.0 for Windows US sub 10551

John,

In all the review we have done with iviewit it seems to boil down to the status of the patents and their inherent value. At that point it is a risk-reward evaluation -- without awarded patents it is difficult to completely assess the value. I would suggest that we consider one other perspective...

Prior to iviewit (approx Feb 2000) the video we (WB Online) delivered on the web was QCIF (160x120) or smaller and was below full frame rate. At the time of our first meeting we also identified On2 along with iviewit as two solid players who could deliver full screen full frame rate web video. All who saw it were impressed. Greg and I visited iviewit in August and reported back that they had filed patents on scaling techniques that hinged upon a visual 'trick' which allowed the human eye to accept 320x240 video scaled to 640x480 at 30 fps as close to VHS quality. We checked with Ken Rubenstein and others who provided some solid support for iviewit, and Chris Cookson asked Greg and I to continue to work with iviewit in an R&D capacity.

In the fall of 2000 iviewit also met with a number of folks at WB Online (in September and October) and demonstrated their process and techniques to Sam Smith, Houston, Joe Annino and others. Sam contacted iviewit a number of times and requested the patents, along with specifics of the iviewit process to evaluate what they were doing. I was not part of these meetings, but was aware they had occurred, as Jack Scanlon kept me up to date.

When I sat down with Morgan and Houston in March 2001 to see what technology they were using to encode video, it was clear that they were using some of the techniques that would overlap with iviewit's filed process patents (still pending), but it is not clear that these were all learned from iviewit -- we may wish to explore this a little. This meeting was to determine what equipment we would get for our lab at 611 Brand. This same information was also provided to iviewit by Morgan as they were establishing the company as an outsourcing facility for encoding our content.

I am aware of several meeting held between iviewit and WB Online to share information of techniques and process, and was invited to a few of them.

We all signed iviewit's confidentiality agreement. So to the other perspective....

We have an opportunity to establish a license with iviewit for a modest fee at this time, and establish a MFN. In good faith we signed the confidentiality agreement, iviewit revealed their processes and techniques, and we now use those techniques in encoding. As we have discussed on a few occasions, these techniques now appear in the public domain to some extent in documentation for Real Producer, WMP Developer Guides, Media Cleaner Pro, etc, but they were not available in 2000. I would not suggest we learned the techniques completely from iviewit (I actually do not know the answer), but a modest licensing fee may be appropriate and honorable considering our good faith relationship in signing the confidentiality doc.

If we choose to pass at this time the risk is primarily from iviewit's main investor, Crossbow Ventures, gaining control of the IP and approaching WB later for a license -- I do not believe they will be as friendly considering their dealings with iviewit and it's employees since Feb of 2001. It is estimated that the patents will be completed in 8-12 months.



As you are all aware I have a personal relationship with Eliot Bernstein, the founder of iviewit, and as a result, I left the evaluations and decisions to Greg, and others, and only assisted iviewit to get to the correct people in WB and AOLTW. I wanted to add this perspective as we consider if there is an option to pursue with iviewit -- they are facing continued financial pressure right now. There are many other threads to our interaction with iviewit and I would be happy to discuss.

Thanx,
David



EXHIBIT M



RESPONDENT IS UNAWARE OF HIS INTEREST IN PROSKAUER

22 Q. Are you a partner of Proskauer
23 Rose?
24 A. Yes.
25 Q. Are you a shareholder of Proskauer

1 Rubenstein
2 Rose?
3 A. One or the other, either partner
4 or shareholder.
5 I think it's a partnership.
6 Q. It's a partnership. Do you have
7 any ownership interest in the partnership in
8 the sense of obligations that go beyond what
9 some of the other partners have? In other
10 words, do you have an equity share? Do you
11 have any other claims with regard to an
12 interest in Proskauer Rose?
13 A. I have no idea.



RESPONDENT IS UNCERTAIN OF HIS START DATE AT PROSKAUER

- 14 Q. And how long have you been
15 employed with Proskauer Rose?
- 16 A. About four, four-and-a-half years.
- 17 Q. Somewhere between 1997 and 1998
18 was your first date of employment?
- 19 A. I think it was in 1998.
- 20 Q. Do you remember a month?
- 21 A. Possibly June.



**SEE COMPACT DISC, ENCLOSED, OF A TAPED CONVERSATION OF MR.
SHIRAJEE ADVISING OF DISCLOSURES TO RESPONDENT**



**ELECTRONIC MAIL MESSAGE FROM SIMON L. BERNSTEIN, FORMER
CHAIRMAN OF THE BOARD OF DIRECTORS OF THE COMPANY**

-----Original Message-----

From: Alyssa Zeiger [mailto:alyssa@lifeinsuranceconcepts.com]
Sent: Friday, May 16, 2003 10:33 AM
To: 'iviewit@worldnet.att.net'
Cc: 'simon@lifeinsuranceconcepts.com'
Subject: FW: response to your letter

Eliot,

Here is my account of those questions you of asked for regarding iviewit Technologies, Inc.

1. Not having Wheeler's testimony it's difficult for me to respond to the 1st question. However, Real 3d (Jerry Stanley) was introduced to us and their opinion including the opinion of their engineering staff was that the patents that we showed them were outstanding and extremely valuable. Mr. Stanley told myself, Eliot, Jerry Lewin and Chris Wheeler that we were onto something big.
2. The problems that were encountered by Ray Joao's work were that it seemed to be incomplete, sloppy and certainly not in a professional manner for which the billings indicated it were. With regard to Foley and Lardner's work, there work also seemed to be incomplete with regard to accomplishing the patent approvals. It was also noted that including work with Mr. Utley they were writing patents in his name.
3. In the same regard Mr. Utley told me when I confronted him with this that it was common for the writer to put new patents in his name but assured me that all patents were assigned to iviewit Technologies, Inc. This was passed on to one of the partners at Proskauer Rose and I was assured that this with in proper conduct.
4. With regard to Ken Rubenstein, I was told by Brian Utley and Chris Wheeler that he was a partner of Proskauer Rose and that he was in fact overseeing our patent work and it also was mentioned that he advised the board of directors with regard to raising capital.
5. It is my opinion that Hank Powell a partner of Crossbow Ventures and also a member of the board of iviewit Technologies, Inc. violated his fiduciary responsibility as said board member to iviewit Technologies, Inc. by recommending iviewit Technologies, Inc. move forward and securing additional loans from Crossbow Ventures. He also told me that Crossbow had no intention of ever collecting on the notes but in fact it gave further protection of iviewit Technologies, Inc. from any other creditors. It is my opinion that this convinced the board of directors to vote on such loans.



6. With regard to Chris Wheeler's recommendation of Bryan Utley it's my opinion that he knew of the past problems Mr. Utley had with Monte Friedkin and withheld this information to myself and to Eliot.
7. My understanding of the relationship between Mr. Utley and Mr. Wheeler is that they are good friends both socially and professionally. Also they served on many boards together.

I believe this covers the pertinent questions you asked me for. I hope this helps.



STATEMENT OF GUY IANTONI, FORMER VICE PRESIDENT OF SALES OF THE COMPANY

June 13, 2003

The following information may be used as my sworn testimony in describing the history and events relating to iviewit (The Company) and its affiliated management and advisors.

As an existing shareholder and personal investor in the Company, I am appalled by the fraud and mismanagement demonstrated by the former President, Brian Utley and legal counsel including: Raymond Joao, Kenneth Rubenstein, Christopher Wheeler and others. I was an employee of the Company since its inception in 1998 to February 2001. I was personally in meetings where Christopher Wheeler recommended Brian Utley as a strong candidate for the President position at iviewit with his experience at IBM. I was one of the first individuals to witness iviewit's zoom and pan technology as well as full-screen, full-frame rate video streaming. I recall viewing iviewit's technologies as early as February of 1998. I attended many meetings with the technologies inventors: Eliot Bernstein, Jude Rosario and Zakirul Shirajee at iviewit's Florida office and witnessed several meetings between the inventors and Raymond Joao. I had discussions with Eliot Bernstein in late 1999 when Eliot expressed his reservations and concerns that the patent work of Raymond Joao, Kenneth Rubenstein and Brian Utley was both incomplete and not representative of the inventors' true findings. I was also present later 1999-2000 as William Dick and Foley and Lardner continued the errors in the patents caused by Raymond Joao and Kenneth Rubenstein.

My personal investment into the Company was largely due to the remarks of attorney Kenneth Rubenstein on a conference call with Eliot Bernstein stating " iviewit's technology will be extremely valuable as part of the MPEG patent pool." I helped author many business plans with Eliot Bernstein, Jim Armstrong, Wachovia Securities and others including Kenneth Rubenstein as a key Company advisor. I attended many face-to-face meetings where Christopher Wheeler both witnessed iviewit's technology and introduced potential clients and investors to the management team. Mr. Wheeler had hand picked the management team and controlled their actions.

It was abusive the amount of unnecessary legal services generated by Christopher Wheeler and Proskauer Rose at such an early stage in the Company's development as we were mislead to believe that these costs would offset revenue by Wheeler/Rubenstein/PR clients and patent pool royalties. I recall the company going through several legal changes including: C-corp, several LLCs, Holding companies, name changes etc. I was stunned to hear that the Company had hundreds of thousands of payables due Proskauer Rose. Brian Utley had primary fiduciary responsibility (or more like irresponsibility) for the use of all investment proceeds, legal services and vendor contracts.

I welcome the opportunity to be personally involved in defending the Company and its assets

Sincerely,

Guy T. Iantoni



STATEMENT OF JAMES F. ARMSTRONG, FORMER VICE PRESIDENT OF SALES & MARKETING OF THE COMPANY

Wednesday, April 30, 2003

Mr. Eliot I. Bernstein
10158 Stonehenge Circle
#801
Boynton Beach, FL. 33437-3546

Dear Eliot,

I have spent the past several evenings reviewing the depositions taken from Wheeler, Utley and Rubenstein and I am stunned. The extent of their lies and their orchestrated obfuscation compels me to reduce to writing some of the experiences that I had with these men. Please use this letter and the statements contained herein as my sworn statement of fact in your continuing effort to expose the truth, punish the evil and reward the deserving.

As a friend of Eliot's, since childhood, I was aware of iviewit from its beginnings but it was only after learning from Chris Wheeler about Ken Rubenstein's favorable opinion regarding iviewit's video and imaging technologies that I became seriously interested in the company. I resigned from a lucrative senior management position with Prudential Securities to help Eliot with his "project". Ultimately, I invested over \$20,000 and declined significant career opportunities in order to begin formally working for iviewit in the fall of 1999. Amongst the most egregious of the statements contained in the depositions is that made by Ken Rubenstein when he claims he does not know iviewit or anything about its technologies or processes. Ken is one of the primary reasons why I and many others invested their time and resources in the company. It was the extremely positive opinions of this highly respected attorney, who has direct links to the MPEG patent pool, which compelled so many of us to make the commitments that we made. Mr. Rubenstein is lying in his deposition.

Similarly, Chris Wheeler denies having any role in the patent work performed for iviewit other than referring us to patent counsel that ultimately ripped us off (but that's a different issue). Eliot, you have done a fine job putting together the billing evidence which is irrefutable. Not only did Wheeler play an instrumental and ongoing role in the handling of the patents, he was the primary contact point with Ken Rubenstein. I also remember Chris, in a meeting held at Real 3D, espousing the novelty of iviewit's inventions and discussing the apparent absence of any prior art in this area. In addition, Chris publicly shared Ken Rubenstein's opinion that the iviewit technologies were "novel". It was during this meeting of Intel and Lockheed engineers that a member of Real 3D's senior management, Rosalie Bibona, stated that iviewit's inventions could be worth billions of dollars. Wheeler states in his deposition that he was unfamiliar with any video inventions until sometime after the Real 3D meeting. Mr Wheeler is lying and everyone present at that meeting can testify to that fact. I was at a meeting held at Si Bernstein's house where Eliot Bernstein, Gerry Lewin, Chris Wheeler, Si Bernstein and Hassan Mia were in attendance. This meeting took place prior to the Real 3D meeting and its purpose was to show Hassan the video streams. It was at this meeting that



Hassan Mia stated "... if what I'm seeing is true, you've found the Holy Grail". The term "Holy Grail" can be found in many early versions of iviewit's business plans.

Let's talk about Brian Utley. This man is a stammering buffoon. Were it not for his resume full of accomplishments and the glowing recommendation of our trusted counsel, he probably never would have passed an initial candidate screening. Unfortunately, we learned too late that many of Brian's accomplishments were fabricated and our trusted advisor, Chris Wheeler, was a liar. I remember a meeting of Eliot, Guy Iantoni, Brian Utley, Mike Reale, Si Bernstein, Chris Wheeler and two investment bankers from Wachovia, Mr. Joe Lee and his associate (I forget his name). Guy and I had prepared a detailed sales forecast that Joe Lee later referred to as the most complete and detailed he'd ever seen. Brian's task was to complete the financials for Joe's review. The work that he presented to Joe Lee was pitiful; it was incomplete, inaccurate and inadequately referenced. In short, it was a disastrous embarrassment. We soon learned that that was the best Utley could deliver. Joe Lee insisted that I complete the financial projections for the business plan and that Utley be removed from the project. This is the sort of talent that our trusted advisor, Chris Wheeler, brought to his client!

From unauthorized patent disclosure to Danny Sokoloff without the protection of an NDA to outright patent sabotage through the use of bad math in patent applications, Utley never failed to disappoint. He was equally inept in corporate matters. I notified Brian on numerous occasions of the firm's responsibility to communicate to shareholders at least once per year and that iviewit was in default on its notes for not having made an interest payment. Like a child, he chose to bury his head in the sand instead of addressing the problem. His exorbitant use of T&E monies is legend and is only exceeded by his inability to complete a sentence without the excessive use of the word "um".

As they say, "hindsight is 20/20". In this case, it's now clear that Wheeler never had iviewit's interests in mind. He was positioning himself and his friends to benefit from iviewit's inventions and creativity. What makes his crime so heinous is that he masqueraded as our friend.

Sincerely,

James F. Armstrong
126 Buttonwood Drive
Fair Haven, NJ. 07704
732-747-4353
email: jjarmstrong@comcast.net



STATEMENT OF SHAREHOLDER MITCHELL A. WELSCH, CFP

Date: 12/11/02

Dear Eliot;

I wanted you to know how I feel about all that I have read recently. As a shareholder and someone that has been around this company since the beginning, I don't know how lawyers like Chris Wheeler and law firms like Proskower Rose could allow statements in a business plan that are not true. Therefore, if the business plan were correct then Mr. Utley would have to be lying under oath. In todays world of fair disclosure, this kind of inconsistency makes me outraged. As a shareholder I encourage and would support action taken to bring any wrongdoing to justice. If nothing else, I am unwilling to allow these deceptions to continue. We should pursue action and be compensated for wrongdoing. I know that if Mr. Rubinstein had not been involved with Iviewit it would have significantly affected my decision to contribute funds when I did. His involvement was communicated to me by Mr. Utley, Mr. Wheeler as well as other involved with the company but as legal representation and president of the company they carried the greatest weight. These inconsistencies are unacceptable and criminal in my opinion. What can we do to bring resolution to this situation and whom do we hold accountable?

Sincerely;

Mitchell A. Welsch, CFP

Mitchell A. Welsch CFP



PASSAGES FROM DEPOSITION OF JERRY LEWIN A PRINCIPAL OF GOLDSTEIN LEWIN, AND THE COMPANY S FORMER OUTSIDE AUDITOR⁵¹

17 Q. Do you recall ever having discussions or
18 hearing discussions among principals of Iviewit that
19 they weren't happy with Proskauer's services?

20 A. The only discussions related was -- Was
21 it Ken Attelman, the one that -- Who was --

22 Q. I can't - I can't answer that.

23 A. You can't answer. There was an attorney
24 in New York that was supposed to oversee the - or
25 involved somehow with the patent. And the

KEN SCHANZER & ASSOCIATES, INC. (954) 922-2660

17

1 discussions were related to was he doing a good
2 enough job overseeing Foley's firm, you know,
3 handling the patent or he supposed --

4 Q. Is this Ken Rubenstein?

5 A. KEN RUBENSTEIN. That's the guy, yes.
6 There were discussions related to Ken Rubenstein and
7 the patents. That was it.

8 Q. Who had those discussions? Who were the

⁵¹ Deposition of Gerald Lewin at 16-17, *Proskauer Rose LLP v. Iviewit.com, Inc. et. al. Case No. CA 01-04671 AB (Circuit Court of the 15th Judicial Circuit in and for Palm Beach County, Florida filed May 2, 2001).*



...STILL MORE MR. LEWIN⁵²

5 Q. Did Proskauer do patent work for Iviewit?

6 A. I'm trying to remember. They did consult
7 an attorney in New York, one of Proskauer's attorneys
8 in New York. I don't recall his name. And I do have
9 to tell you I'm not very good with names.

17 Q. Were there any disagreements concerning
18 the manner in which the patents had been filed or the
19 names under which the patents had been filed?

20 A. I don't recall on the names. I recall
21 there were maybe disagreements of - you know, which I
22 don't understand - I do not understand patents - of
23 whether papers were prepared this way or that way or
24 properly or improperly or -- You know, maybe those
25 were discussions.

⁵² *Supra* Note 49 at 55-56.



EXHIBIT N



SECTION 115 OF PATENT ACT

TITLE 35 PART II CHAPTER 11 Sec. 115.

Sec. 115. - Oath of applicant

The applicant shall make oath that he believes himself to be the original and first inventor of the process, machine, manufacture, or composition of matter, or improvement thereof, for which he solicits a patent; and shall state of what country he is a citizen. Such oath may be made before any person within the United States authorized by law to administer oaths, or, when, made in a foreign country, before any diplomatic or consular officer of the United States authorized to administer oaths, or before any officer having an official seal and authorized to administer oaths in the foreign country in which the applicant may be, whose authority is proved by certificate of a diplomatic or consular officer of the United States, or apostille of an official designated by a foreign country which, by treaty or convention, accords like effect to apostilles of designated officials in the United States, and such oath shall be valid if it complies with the laws of the state or country where made. When the application is made as provided in this title by a person other than the inventor, the oath may be so varied in form that it can be made by him. For purposes of this section, a consular officer shall include any United States citizen serving overseas, authorized to perform notarial functions pursuant to section 1750 of the Revised Statutes, as amended (22 U.S.C. 4221)



EXHIBIT O



LETTER OF MR. COLTER DESCRIBING RESPONDENT S INVOLVEMENT

-----Original Message-----

From: David.Colter@warnerbros.com [mailto:David.Colter@warnerbros.com]

Sent: Wednesday, August 01, 2001 10:28 PM

To: HeidiKrauel@aol.com

Cc: HPowell@cb-ventures.com; Eliot@iviewit.com

Subject: Re: Today -- iviewit

Heidi,

Here is the info for Hank Powell from Crossbow Ventures. I have copied him above to make the introduction.

iviewit has undergone a restructuring of their business from an encoding focused business to a technology licensing business focus over the past 4-5 months. They are in the process of establishing a new executive team to handle this 'new' direction and have been working on the new business plan. They have indicated that we should have the revised plan next week.

They currently are finalizing a contract with WB Online to provide encoding services as a hold over from our original collaboration, and as a showcase for the technologies and patents.

Their site www.iviewit.com contains good demonstrations of the zooming and video encoding technologies. I have also copied the inventor/founder Eliot Bernstein, who I will ask to provide some specific links on the site to see the best representation of their work and technical capabilities.

Their patents are pending, but have received favorable opinions from people such as Ken Rubenstein on the merit of the patents, as well as thorough review by Greg Thagard and myself.

Let's talk further after you see the business plan and connect with Hank.

Thanx,
David



ANOTHER LETTER OF MR. COLTER DESCRIBING RESPONDENT S INVOLVEMENT

From: David.Colter@warnerbros.com
Sent: Tuesday, January 15, 2002 12:51 AM
To: John.calkins@warnerbros.com
Cc: CHuck.dages@warnerbros.com; Alan.Bell@warnerbros.com
Subject: iviewit

John,

In all the review we have done with iviewit it seems to boil down to the status of the patents and their inherent value. At that point it is a risk-reward evaluation -- without awarded patents it is difficult to completely assess the value. I would suggest that we consider one other perspective...

Prior to iviewit (approx Feb 2000) the video we (WB Online) delivered on the web was QCIF (160x120) or smaller and was below full frame rate. At the time of our first meeting we also identified On2 along with iviewit as two solid players who could deliver full screen full frame rate web video. All who saw it were impressed. Greg and I visited iviewit in August and reported back that they had filed patents on scaling techniques that hinged upon a visual 'trick' which allowed the human eye to accept 320x240 video scaled to 640x480 at 30 fps as close to VHS quality. We checked with Ken Rubenstein and others who provided some solid support for iviewit, and Chris Cookson asked Greg and I to continue to work with iviewit in an R&D capacity.

In the fall of 2000 iviewit also met with a number of folks at WB Online (in September and October) and demonstrated their process and techniques to Sam Smith, Houston, Joe Annino and others. Sam contacted iviewit a number of times and requested the patents, along with specifics of the iviewit process to evaluate what they were doing. I was not part of these meetings, but was aware they had occurred, as Jack Scanlon kept me up to date.

When I sat down with Morgan and Houston in March 2001 to see what technology they were using to encode video, it was clear that they were using some of the techniques that would overlap with iviewit's filed process patents (still pending), but it is not clear that these were all learned from iviewit -- we may wish to explore this a little. This meeting was to determine what equipment we would get for our lab at 611 Brand. This same information was also provided to iviewit by Morgan as they were establishing the company as an outsourcing facility for encoding our content.

I am aware of several meetings held between iviewit and WB Online to share information of techniques and process, and was invited to a few of them.

We all signed iviewit's confidentiality agreement. So to the other perspective....

We have an opportunity to establish a license with iviewit for a modest fee at this time, and establish a MFN. In good faith we signed the confidentiality agreement, iviewit revealed their processes and techniques, and we now use those techniques in encoding. As we have discussed on a few occasions, these techniques now appear in the public domain to some extent in documentation for Real Producer, WMP Developer Guides, Media Cleaner Pro, etc, but they were not available in 2000. I would not suggest we learned the techniques completely from iviewit (I actually do not know the answer), but a modest licensing fee may be appropriate and honorable considering our good faith relationship in signing the confidentiality doc.

If we choose to pass at this time the risk is primarily from iviewit's main investor, Crossbow Ventures, gaining control of the IP and approaching WB later for a license -- I do not believe they will be as friendly considering their dealings with iviewit and its employees since Feb of 2001. It is estimated that the patents will be completed in 8-12 months.

As you are all aware I have a personal relationship with Eliot Bernstein, the founder of iviewit, and as a result, I left the evaluations and decisions to Greg, and others, and only assisted iviewit to get to the correct people in WB and AOLTV. I wanted to add this perspective as we consider if there is an option to pursue with iviewit -- they are facing continued financial pressure right now. There are many other threads to our interaction with iviewit and I would be happy to discuss.

Thanx,
David



STATEMENT OF CEO LAMONT

I met with Mr. Rubenstein in the New York offices of Proskauer Rose LLP on Monday January 7, 2002 at 11:30 A.M. Moreover, the purpose of my visit was three fold: (I) to invite him to **REJOIN** the Advisory Board along with David Colter, Vice President of Advanced Technology of Warner Bros. and Greg Thagard, formerly of Warner Bros. and left with him a copy of the Company's January 2002 Business Plan, an Advisory Board Member Agreement, and a Warrant Grant to purchase 450 share of the Company as compensation; (II) to begin a series of discussions pointing to the essentiality of the Iviewit patents pending in his role as patent evaluator of the multimedia patent pools known as MPEG 2 and MPEG 4; and (III) to have a face to face discussion as a means to allow me to ask him to speak to Wayne M. Smith, Vice President & Senior Litigation and Patent Counsel at Warner Bros. to reiterate his prior statements to Warner Bros. executives and overcome his purported conflict that was previously waived. Much to my surprise, during our discussion, Mr. Rubenstein disavowed any knowledge of the Company's patents pending, at which time I felt a bit of embarrassment. Embarrassed, because, once assuming the CEO position, I had prior knowledge of his speaking to people at Warner Bros., such as, but not limited to David Colter, Greg Thagard, and Chris Cookson, and thought I might have interpreted an incorrect picture of those prior discussions. Lastly, I advised him of my discussions with Warner Bros. pertaining to an Advanced Royalty Agreement ("ARA").

Moreover, in reviewing Company documentation, I came across more instances of business plans naming him as an Advisory Board Member, multiple emails of investors and potential licensees naming Mr. Rubenstein as an individual entirely familiar with the Company's technologies, and parole evidence stating that Mr. Rubenstein, when initially the recipient of the Company's disclosures claimed the technologies were "novel," and that "he had missed that," and that "we had never thought of that," and finally that "this changes everything."

Furthermore, although I became a bit suspicious after the meeting with Mr. Rubenstein, and as the Warner Bros. discussions began to break down due to Mr. Rubenstein's reticence at speaking to Warner Bros., I felt comfortable enough in asking Mr. Rubenstein to place a phone call to Mr. Smith of Warner Bros., for what amounts to the third time, who was the patent attorney assigned the task of reviewing the Company filings for purposes of evaluating the ARA and the AOL Time Warner investment. Mr. Smith had been requesting a conversation with Mr. Rubenstein dating back to December 20, 2001, for the purposes of describing for good or bad his aforementioned knowledge of the Company's patents pending, and that he had formerly described as "novel," on varied occasions to Mr. Colter, Mr. Thagard, and others at Warner Bros. At this point, and based on nearly ten years experience as a technology executive, I suspected that something was wrong in the Company's patent filings, as in my prior experiences, the patent applications or patents issued usually had spoken for themselves, but in this instance, Mr. Smith was seemingly interested in a check of his reading and view of the Company's filings.



Much to my surprise, **AGAIN**, Mr. Rubenstein, not now disavowing knowledge of the Company's patents pending, refused said request based on conflicts of interest as Warner Bros "is a big client here." Surprised, **YET AGAIN**, as I was aware of his prior representations to Warner Bros. where no conflicts of interests were stated, at least not to my knowledge and in my review of Company documentation, I may have advised Mr. Rubenstein in still another phone conversation, that his purported conflicts of interest were waived on both sides, but that at least "could Mr. Smith call you [Mr. Rubenstein]," to which he agreed, however, paraphrasing, "he would not be positive or negative" in that regard. Moreover, he refused to place calls himself much in the same way as he had previously, only this time with anxiety and/or anger in his voice. Subsequent to his refusal, Warner Bros. declined the ARA and AOL Time Warner declined an investment in the Company, based on their confusion surrounding the lack of critical elements of the inventions in the Company's patents pending.

Additionally, it appears that Mr. Rubenstein's refusal to again speak affected not only the Warner Bros ARA, the AOL Time Warner investment, but had direct impact on the next discussions with, including but not limited to, SONY Corporation and what was to become Movielink, LLC (a five studio digital download movie service that was to generate licensing revenue for the Company as envisioned by the Company's business plans).

Still further, as my suspicions grew, I consulted with the Company's founder and main inventor, Mr. Bernstein, who contacted Caroline P. Rogers, Esq. to enlist her help in finding a law firm to conduct an independent review of the Company's patents pending. As of April 2002, the Chicago office of Greenberg Traurig LLP submitted their review at the behest of Ms. Rogers, and advised the Company of the missing critical elements of the Company's inventions that would materially not support the claims in said filings.

Lastly, much to my dismay, and when viewing the Company's inventions as a direct, competitive threat to, including but not limited to Mr. Rubenstein's MPEG 2 and MPEG 4 patent pools of which Mr. Rubenstein who, by his own admission is counsel to the MPEGLA LLC entity that functions as licensor of those pools, and is, to the best of the Company's knowledge, the patent evaluator who decides the "essentiality" of any patent with a view to admission to those pools, my suspicions grew even stronger.

As a result of discussions on the events with Mr. Bernstein, and by my own hand, I drafted the following letter to Mr. Rubenstein on April 25, 2002, and as evidenced by right clicking the document and choosing "Properties" wherein it evidences the date of creation and the date of modification (despite the WORD document's "update automatically" function), not so much, as it appears as an invitation to engage, but as a mechanism to allow Mr. Rubenstein to "save his soul," as my suspicions of the events surrounding the Company's patent prosecution process from 1998 to 2001, were grave indeed; I have knowledge that this letter, in draft form, was submitted to Mr. Rubenstein in his deposition in the Litigation, where he was given time to read and comment upon its contents:



Draft

6/18/2003



IVIEWIT HOLDINGS, INC.

P. Stephen Lamont
Chief Executive Officer
Direct Dial: 914-217-0038

By Electronic Mail and Facsimile

June 18, 2003

Kenneth Rubenstein
Partner
Proskauer Rose LLP
1585 Broadway
New York, NY 10036

Re: Iviewit Patents Pending

Dear Ken:

Last we spoke, Wayne Smith of Warner Bros. requested a conversation with you pertaining to Iviewit patents pending, of which you denied indepth knowledge of same and, additionally, stated conflict of interest issues. Sadly, Iviewit has submitted Return of Property papers and a soon to be issued Cease and Desist letter to Warner Bros. for breach of a Confidentiality Agreement executed in August 2000, and ignorance of a reasonable license agreement to remedy said breach.

In any event, I am writing for another reason as I came across a piece of perplexing information earlier today. I stumbled upon some documentation that named you as an Advisory Board member of the company somewhere between the fall of 1999 and the spring of 2000.

Moreover, recalling your own words, as I sat in your office earlier in the year, of your present unfamiliarity with the Iviewit techniques and unwillingness to speak on behalf of what I have since heard you describe as "novel" approaches to video perplexes me to a certain extent when I view you as a former Advisory Board member, if you ever held such a designation.

Further, and I should not be relaying this to you, but there are rumors swirling around the company with finger pointing and all from Florida to Los Angeles wherein it catches the jet stream and arrives very soon in New York of alleged breaches of confidentiality pertaining to Iviewit technology, transfers of trade secrets, and, even in certain circumstances, knowing and willful invention fraud by the outright switching of signature



Draft

6/18/2003



Kenneth Rubenstein
June 18, 2003
Page 2

pages of patent filings by some earlier patent counsels appointed by the company, including, but not limited to one Mr. Ray Joao, formerly, it is my understanding, of Meltzer, Lippe, Goldstein & Schlissel, P.C., and an individual that, it is also my understanding, you have worked closely with in the past pertaining to Iviewit and other matters. Moreover, it is also my understanding, that you were the first individual to be presented with the Iviewit proprietary techniques, and passed along the work to your past associate, Mr. Joao, and "reviewed" same prior to, during, and, perhaps, after your transition from the Meltzer firm to Proskauer, and in whatever capacity "reviewed" refers to.

At this juncture in my tenure as Iviewit CEO, I have ordered a full legal audit of the company both from a business perspective and an intellectual property perspective. With the results of said audit nearly complete, the preliminary intellectual property conclusions relayed astound me to the point that I have been told that the Iviewit patents pending are akin to patenting "peanut butter."

Furthermore, I have been told of your past involvement with the Iviewit proprietary techniques, of your conversations about the Iviewit techniques with, including, but not limited to, Greg Thagard, Greg Cookson, and David Colter among others, and your initial conclusion of the novelty of the Iviewit techniques, and I ask myself, "Why, why has past patent counsel failed to patent the inventions as specified by our inventor?" Moreover, I ask myself "Why do the description of the inventions fail to lead one to believe that Iviewit had invented anything at all?"

Still further, I think back to the comments I have heard of your initial reaction to the Iviewit techniques and describing them as "novel," which leads me to the conclusion that in your role as overseer of many patent pools, combined with your description of the novelty of the Iviewit techniques, you had not seen scaling in your review of patents pertaining to the essentiality of any given pool, and I ask myself further, "Why is the Iviewit scaling method now so far reaching and ubiquitous in many, varied patent pools overseen by yourself and others of similar stature?"

As such, I would like to enlist your assistance, if available, to review the conclusions of past and present patent counsel, and to further assist Iviewit in further defining the inventions in any intellectual property arena of our choosing, whether it be by a petition by what process is available at the United States Patent and Trademark Office, or any administrative, state, or federal court of appropriate jurisdiction armed with executed



Draft

6/18/2003



Kenneth Rubenstein
June 18, 2003
Page 3

documents, memos, emails, and parole evidence all pointing to fraudulent, or at the least entirely malpractical occurrences regarding the filings of the past Iviewit patents pending.

Lastly, as I mentioned above, I have ordered a full legal and accounting audit of the company many weeks ago, and I expect the completion of same shortly, and I would appreciate a response at your earliest convenience.

Best regards,

P. Stephen Lamont
Chief Executive Officer



EXHIBIT P



FOLEY & LARDNER S REQUEST FOR MR. JOAO S DOCUMENTS

JUN. 6.2000 3:36PM 33RD FLOOR

NO. 920 P. 1/8

Atty. User ID: 0128 Client/Matter Code: 57103/101

FOLEY & LARDNER Attorneys at Law

Sender's Direct Line: (414) 297-5718

Firststar Center 777 East Wisconsin Avenue Milwaukee, Wisconsin 53202-5367 TELEPHONE (414) 271-2400 FACSIMILE (414) 297-4900

FACSIMILE TRANSMISSION COVER SHEET

TO: Mr. Brian G. Utley COMPANY NAME: Iviewit.com, Inc. COMPANY LOCATION: Boca Raton, Florida COMPANY PHONE NUMBER: TEL: (561) 999-8899 COMPANY FAX NUMBER: FAX: (561) 999-8810 FROM: Douglas A. Boehm DATE: June 6, 2000

TOTAL NUMBER OF PAGES INCLUDING COVER SHEET: 8

IF THERE ARE ANY PROBLEMS WITH THIS FACSIMILE TRANSMISSION, OR IF YOU HAVE NOT RECEIVED ALL OF THE PAGES, PLEASE CALL 414/297-5444.

CONFIDENTIALITY NOTICE: THE INFORMATION CONTAINED IN THIS FACSIMILE MESSAGE IS INTENDED ONLY FOR THE PERSONAL AND CONFIDENTIAL USE OF THE DESIGNATED RECIPIENTS NAMED ABOVE. THIS MESSAGE MAY BE AN ATTORNEY-CLIENT COMMUNICATION, AND AS SUCH IS PRIVILEGED AND CONFIDENTIAL. IF THE READER OF THIS MESSAGE IS NOT THE INTENDED RECIPIENT OR ANY AGENT RESPONSIBLE FOR DELIVERING IT TO THE INTENDED RECIPIENT, YOU ARE HEREBY NOTIFIED THAT YOU HAVE RECEIVED THIS MESSAGE IN ERROR, AND THAT ANY REVIEW, DISSEMINATION, DISTRIBUTION, OR COPYING OF THIS MESSAGE IS STRICTLY PROHIBITED. IF YOU HAVE RECEIVED THIS MESSAGE IN ERROR, PLEASE NOTIFY US IMMEDIATELY BY TELEPHONE AND RETURN THE ORIGINAL MESSAGE TO US BY MAIL. THANK YOU.

Brian, Here is your copy of what was just faxed to Mr. Lewis S. Meltzer.

Fax Operator: Time Sent:



JUN. 6.2000 3:36PM 33RD FLOOR

NO. 920 P. 2/8

FOLEY & LARDNER

ATTORNEYS AT LAW

CHICAGO
DENVER
JACKSONVILLE
LOS ANGELES
MADISON
MILWAUKEE
ORLANDO

FIRST STAR CENTER
777 EAST WISCONSIN AVENUE
MILWAUKEE, WISCONSIN 53202-5397
TELEPHONE (414) 271-2400
FACSIMILE (414) 297-4800

SACRAI
SAN
SAN FRAN
TALLAH
WASHINGTON
WEST PALM E

EMAIL ADDRESS
daboehm@foleylaw.com

Via Facsimile

WRITER'S DIREC
(414) 297-

June 6, 2000

Mr. Lewis S. Meltzer
Meltzer, Lippe, Goldstein & Schlissel, P.C.
190 Willis Avenue
Mineola, New York 11501

Re: Transfer of IP files for IVIEWIT.COM

Dear Mr. Meltzer:

As you may recall, I am the patent attorney at Foley & Lardner that is currently handling the Iviewit.com IP matters that were previously handled by Ray Joao of your firm.

I recently received the following correspondence from your firm: (1) the original Assignment recorded in the United States Patent and Trademark Office (USPTO) for your Docket No. 5865-8 (U.S. Provisional Patent Application No. 60/169,559); and (2) the USPTO Filing Receipt (copy attached) for your Docket No. 5865-1 for Application No. 09/522,721. Although I sincerely appreciate your firm's diligence in continuing to forward Iviewit materials to me, this latest correspondence raises some very serious issues with respect to the Iviewit.com IP matters that were supposed to have been transferred to Foley & Lardner.

I was not previously told about this U.S. Non-Provisional Application being filed (item 2 above). It does not appear in any of the correspondence previously sent to Foley & Lardner. This raises the question of exactly what was filed in the U.S. Patent and Trademark Office, since I do not have a copy of any filing papers for this application. Was a U.S. Declaration filed? What specification and claims were filed? Was an Assignment filed for this application? I must have this information in order to take over prosecution of this application.

More importantly, however, this raises the question of whether any other provisional or non-provisional applications have been filed in the United States or any other country. Both the client, Brian Utley, President of Iviewit.com, and myself have previously asked your firm to transfer all of the Iviewit.com Intellectual Property files to me. (See attached letter to you dated April 28, 2000.) When the files that were sent to me were incomplete, I sent an e-mail (copy attached) to Dawn Laffin of your firm, asking her to look for other Iviewit matters. I subsequently requested that Nicole, Ray's former secretary,

001.793919.2

ESTABLISHED 1842

A MEMBER OF GLOBALEX WITH MEMBER OFFICES IN BERLIN, BRUSSELS, DRESDEN, FRANKFURT, LONDON, SINGAPORE, STOCKHOLM AND STUTTGART



JUN. 6.2000 3:37PM 33RD FLOOR

NO.920 P.3/8

FOLEY & LARDNER

Mr. Lewis S. Meltzer
June 6, 2000
Page 2

double-check that there were no other miscellaneous files that were not on the list of applications (also attached). Now I find out that, after three or four separate requests, all of the Iviewit patent matters were not transferred to us.

I formally request that you have your firm's Docket Administration Department review all of Ray Joao's files to ensure that all of the Iviewit.com materials have been transferred to me. Please forward all letters, memorandums, faxes, e-mails, notes, CD's, disks, and other correspondence between Iviewit.com and your firm, and between any third parties and your firm on behalf of Iviewit.com. It is particularly important that I know which patent applications were filed and what correspondence was submitted to the U.S. Patent & Trademark Office before the expiration of a critical date. Otherwise, the client could possibly lose patent rights. Please confirm that the attached "Iviewit.com Patent Portfolio" table, which lists the patent applications filed for Iviewit.com by your firm, is accurate and complete.

I also request that you contact Ray Joao to confirm which applications were filed in what countries and whether or not Ray has any additional Iviewit correspondence or materials that were not transferred to Foley & Lardner.

Furthermore, the client requests that I obtain a written confirmation from both you and Ray that all files, materials, and correspondence have been transferred to Foley & Lardner.

Please confirm receipt of this facsimile and let me know that these matters will be handled promptly and appropriately.

Very truly yours,

Douglas A. Boehm

Enclosure(s)

cc: Mr. Brian Utley, Iviewit.com



Boehm, Douglas A.

From: Boehm, Douglas A.
Sent: Tuesday, May 09, 2000 5:28 PM
To: 'djaffin@mlg.com'
Subject: iviewit.com Files

Dawn --

As I mentioned on the telephone this afternoon, I received your Federal Express package this morning containing the Meltzer, Lippe files for iviewit.com. The package contained 7 folders corresponding to your docket numbers 5865-1,3,4,4.1,5,6, and 7. However, the file folder for your docket no. 5865-8 is missing. Furthermore, not all of the paperwork for the PCT application (your docket no. 5865-10) was included in the first file 5865-1 (which is the PCT's parent case). Is there a 5865-10 file also?

During our phone conversation, you agreed to review your docket and files for 5865-8, 5865-10, and any other 5865 matters for iviewit.com tomorrow, and forward these files to me right away.

Thanks for your assistance.

--Doug

*Douglas A. Boehm
Foley & Lardner
777 East Wisconsin Avenue
Milwaukee, Wisconsin 53202
Tel: (414)297-5718
Fax: (414)297-4900
Email: dab Boehm@foleylaw.com*

NOTE: The information transmitted in and/or attached to this message is intended only for the person or entity to which it is addressed and may contain confidential and/or privileged material. Any review, retransmission, dissemination, or other use of, or taking any action in reliance upon, this information by persons or entities other than the intended recipient is prohibited. If you received this information in error, please contact the sender and delete the material from any computer.



TRANSCRIPTION OF TELECONFERENCE⁵³ REFERENCING MR. JOAO S DESTRUCTION OF NOTES AND OTHER PATENT MATERIALS

Simon Bernstein: I just have one question. Does anybody have, or are we allowed to get, the files of Ray Joao?

Boehm: I have them.

Wheeler: Do you have all of the work that he had?

Bernstein: No, not all of it.

Utley: What was purported to be in the files?

Bernstein: And he also claimed to us that he destroyed part of his files.

Boehm: And I have some of his files. I have what was purported to be all of the firms' files.

<Inaudible comment.>

Utley: Well, there's a whole history, then, because I tried to get complete copies of the files originally, and found out later that not only did he not send us all the files, he didn't even mention that there was an extra filing out there that we didn't even know about.

Bernstein: This one that's in question.

Boehm: Yep

Simon Bernstein: You have no notes, no data on...?

Boehm: No, I have the application. I have things that you could get from the US patent office—that I could get from the US patent office. I have very few notes. I do have some scribbled Ray Joao's notes, but I think you gave me those notes.

Utley: I did. I gave you Bill Dick after Bill yourself[] the notes that I had.

Bernstein: And Ray's made disclosures to us that he destroyed the documents to protect us, which I don't know what he was thinking.

2

Simon Bernstein: Destroyed what documents?

Bernstein: Whatever he had in his files. Other patent copies, copies of the drafts as they proceeded...all that he destroyed to protect us from something I asked him to explain, and his reasoning...because I said to him, you know, usually you destroy documents when you are protecting somebody from something illegal or something. Have I done something that would force you to hurt me possibly? He said it was typical, normal, that all lawyers destroy their records.

⁵³ Footnote transcription...



Simon Bernstein: If that, in fact, is the case—I've never heard of a lawyer you know other than Nixon destroying anything the work is ours. Am I right Chris when we pay for a lawyer and we pay for the work, the work is ours.

Wheeler: The work product is yours. He may maintain copies of his files and everything; or his confidential notes to himself are not necessarily yours. But the work "product" is...

Simon Bernstein: Would you say that anything germane to the issue belongs to him?

Wheeler: Well, I mean if he wrote notes...in sidebars...yeah.

Bernstein: How about revised patents[]. How about copies? Works in progress

Wheeler: But things which would reinforce your patent, obviously, that is germane to the strength of your patent yes, you would be entitled to copies I don't think we disagree.

Bernstein: He's claiming He destroyed all faxes.



RESPONDENT S DEPOSITION STATEMENT THAT HE TAKES NO NOTES

7 Q. Did you keep any notes of your
8 conversation with regard to this referral?

9 A. No.

10 Q. Did you speak to Mr. Joao with
11 regard to this referral?

12 A. I don't recall.

17 Q. Did you keep any files yourself
18 with regard to IViewIt and any communications
19 with IViewIt?

20 A. I don't think so, no.



EXHIBIT Q



[INSERT COUNTERCLAIM]

IN THE CIRCUIT COURT OF THE
15TH JUDICIAL CIRCUIT IN AND
FOR PALM BEACH COUNTY,
FLORIDA

PROSKAUER ROSE L.L.P.,
a New York limited partnership,

CA 01-04671 AB

Plaintiff,

v.

IVIEWIT.COM, INC., a Delaware
corporation, IVIEWIT HOLDINGS,
INC., a Delaware corporation, and
IVIEWIT TECHNOLOGIES, INC.,
a Delaware corporation.

Defendants.

COPY / ORIGINAL
RECEIVED FOR FILING

JAN 28 2003

DOROTHY H. WILKEN
CLERK OF CIRCUIT COURT
CIRCUIT CIVIL DIVISION

**DEFENDANTS MOTION FOR LEAVE TO AMEND TO ASSERT
COUNTERCLAIM FOR DAMAGES**

Defendants, IVIEWIT.COM, INC., IVIEWIT HOLDINGS,
INC. and IVIEWIT TECHNOLOGIES, INC., by and through their undersigned
counsel, hereby move this Court for Leave to Amend their Answer so as to assert a
counterclaim in this matter pursuant to Rule 1.170(f) of the Florida Rules of Civil
Procedure and as grounds therefore would state as follows:

1. That the Defendants move to amend their answer in this matter so as to
include a counterclaim in this matter, which by its nature appears to be a compulsory
counterclaim to the extent that the issues arise out of the same nexus of events, as

justice requires that the counterclaim be tried at the same time as the complaint and answer so that all pending issues between the parties may be adjudicated in this action.

2. That as a result of fact that additional evidence in support of the Defendants' counterclaims is found in the Plaintiff's own files and records, the Plaintiff will not be prejudiced by the amendment of the Defendants' answer in this matter, nor will this matter be delayed as to the trial of same.

3. Defendants have attached hereto a copy of the proposed counterclaim.

WHEREFORE the Defendants, move this Honorable Court for the entry of an order permitting the Defendants to amend their answer in this matter.

I HEREBY CERTIFY that a true and correct copy of the foregoing has been provided by U.S. Mail and fax transmission this 20th day of January, 2003 to: Christopher W. Prusaski, Esq., Proskauer Rose, LLP, 2255 Glades Road, Suite 340 W, Boca Raton, FL 33431.

SELZ & MUVDI SELZ, P.A.
214 Brazilian Avenue, Suite 220
Palm Beach, FL 33480
Tel: (561) 820-9409
Fax: (561) 833-9715

By: 
STEVEN M. SELZ
FBN: 777420

IN THE CIRCUIT COURT OF THE
15th JUDICIAL CIRCUIT IN AND
FOR PALM BEACH COUNTY,
FLORIDA

PROSKAUER ROSE, LLP, a New York
limited partnership,

CASE NO.: CA 01-04671 AB

Plaintiff,

vs.

IVIEWIT.COM, INC., a Delaware
corporation, IVIEWIT HOLDINGS,
INC., a Delaware corporation and,
IVIEWIT TECHNOLOGIES, INC.,
a Delaware corporation,

Defendants,

COUNTERCLAIM FOR DAMAGES

COME NOW the Counter Plaintiffs, IVIEWIT.COM, INC., IVIEWIT
HOLDINGS, INC., IVIEWIT TECHNOLOGIES, INC. and IVIEWIT LLC,
hereinafter collectively referred to as "IVIEWIT" or Counter Plaintiffs, and hereby
sues Counter Defendant, PROSKAUER ROSE, LLP, hereinafter "PROSKAUER",
a New York limited partnership, and alleges as follows:

GENERAL ALLEGATIONS COMMON TO ALL COUNTS

1. This is an action for damages in a sum greater than \$15,000.00, exclusive

of interest, taxable costs and attorneys fees.

2. Counter Plaintiff, IVIEWIT.COM, INC., is a Delaware corporation, formed by PROSKAUER, which at all times relevant hereto was authorized to conduct and conducted business in Palm Beach County Florida and the State of California.

3. Counter Plaintiff, IVIEWIT HOLDINGS, INC., is a Delaware corporation, formed by PROSKAUER, which at all times relevant hereto was authorized to conduct and conducted business in Palm Beach County Florida and California.

4. Counter Plaintiff, IVIEWIT TECHNOLOGIES, INC., is a Delaware corporation, formed by PROSKAUER, which at all times relevant hereto was authorized to conduct and conducted business in Palm Beach County Florida and the State of California.

5. IVIEWIT LLC, is a Florida limited liability company, formed by PROSKAUER, which, at all times relevant hereto, was authorized to conduct and conducted business in the Palm Beach County Florida and the State of California.

6. Counter Defendant PROSKAUER ROSE, LLP, (hereinafter "PROSKAUER") is a New York limited partnership, operating a law office in Boca Raton, Palm Beach County, Florida.

Boca Raton, Palm Beach County, Florida.

7. BRIAN G. UTLEY, (hereinafter "UTLEY") was at all times relevant hereto a sui juris resident of the State of Florida and who on or about September of 1999 was the president of Counter Plaintiff, IVIEWIT LLC.

8. CHRISTOPHER WHEELER, (hereinafter "WHEELER") is a sui juris individual and resident of Palm Beach County, Florida, who at all times relevant hereto was a partner of PROSKAUER and who provided legal services to the Counter Plaintiffs.

9. KENNETH RUBENSTEIN, (hereinafter "RUBENSTEIN") is a sui juris individual believed to be a resident of the State of New York and who various times relevant hereto was initially misrepresented by WHEELER as a partner of PROSKAUER and later became a partner of PROSKAUER, and who provided legal services to the Counter Plaintiffs both while at Meltzer, Lippie, et al., and PROSKAUER.

10. RAYMOND JOAO, (hereinafter "JOAO") is a sui juris individual believed to be a resident of the State of New York and who at all times relevant hereto was represented to be RUBENSTEIN's associate at PROSKAUER, when in fact JOAO has never been an employee of PROSKAUER but in fact was an employee of Meltzer, Lippie, et al.

11. That beginning on or about November of 1998, the Counter Plaintiff, IVIEWIT, through it's agent and principal, Eliot I. Bernstein ("Bernstein"), held discussions with WHEELER with regard to PROSKAUER providing legal services to the company involving specific technologies developed by Bernstein and two others, which technologies allowed for:

i) Zooming of digital images and video without degradation to the quality of the digital image due to what is commonly referred to as "pixilation";
and,

ii) The delivery of digital video using proprietary scaling techniques;
and,

iii) A combination of the image zoom techniques and video scaling techniques described above; and,

iv) The remote control of video cameras through communications networks.

12. That Bernstein engaged the services of PROSKAUER to provide legal services to the company to be formed, including corporate formation and governance for a single entity and to obtain multiple patents and oversee US and foreign filings for such technologies including the provisional filings for the technologies as described in Paragraph 11 above, the "Technology", and such

other activities as were necessary to protect the intellectual property represented by the Technology.

13. That at the time of the engagement of PROSKAUER, Bernstein was advised and otherwise led to believe that WHEELER was the PROSKAUER partner in charge of the account.

14. Upon information and belief, WHEELER, RUBENSTEIN and JOAO upon viewing the technologies developed by Bernstein, and held by IVIEWIT, realized the significance of the technologies, its various applications to communication networks for distributing video data and images and for existing digital processes, including, but not limited to digital cameras, digital video disks (DVD), digital imaging technologies for medical purposes and digital video, and that WHEELER, RUBENSTEIN and JOAO conspired to undertake and in fact undertook a deliberate course of conduct to deprive Bernstein and IVIEWIT of the beneficial use of such technologies for either the use of third parties, who were other clients of PROSKAUER and WHEELER, or for WHEELER, RUBENSTEIN and JOAO's own financial gain, to the detriment and damage of the Counter Plaintiffs.

15. That WHEELER, who was a close personal friend of UTLEY, recommended to Bernstein and other members of the board of directors of

IVIEWIT that the IVIEWIT engage the services of UTLEY to act as President of the Iviewit.com, LLC based on his knowledge and ability as to technology issues.

16. That at the time that WHEELER made the recommendation of UTLEY to the board of directors, that WHEELER knew that UTLEY was in a dispute with his former employer, Diamond Turf Products and the fact that UTLEY had misappropriated certain patents on hydro-mechanical systems to the detriment of Diamond Turf Products.

17. Additionally, WHEELER was fully aware of the fact that UTLEY was not the highly qualified "engineer" that UTLEY represented himself to be, and that in fact UTLEY lacked real engineering expertise or even an engineering degree and that UTLEY had been fired from Diamond Turf Products due to his misappropriation of patents.

18. That despite such knowledge, WHEELER never mentioned such facts concerning UTLEY to any representative of IVIEWIT and in fact undertook to "sell" UTLEY as a highly qualified candidate who would be the ideal person to undertake day to day operations of IVIEWIT and work on the patents, acting as a qualified engineer.

19. Additionally, WHEELER continued to assist UTLEY in perpetrating such fraud on both the Board of Directors of IVIEWIT and to third parties,

including Wachovia Bank, by approving a false resume for UTLEY to be included in seeking approval of a private placement for IVIEWIT.

20. That based on the recommendations of WHEELER, as partner of PROSKAUER, the board of directors agreed to engage the services of UTLEY as president.

21. That almost immediately after UTLEY's employment and almost one year after initially providing of services, WHEELER provided a retainer agreement for the providing of services by PROSKAUER to IVIEWIT LLC, addressed to UTLEY, a true and correct copy of such retainer agreement (the "Retainer") being attached hereto and made a part hereof as Exhibit "A". That the services provided were in fact to be paid out of the royalties recovered from the use of the Technology, which was to be included in patent pools overseen by RUBENSTEIN.

22. That the Retainer by its terms contemplated the providing of corporate and general legal services to IVIEWIT LLC by PROSKAUER and was endorsed by UTLEY on behalf of IVIEWIT LLC, the Board of Directors of IVIEWIT LLC would not have UTLEY authorized to endorse same as it did not include the intellectual property work which PROSKAUER had already undertaken.

23. That prior to the Retainer, PROSKAUER and WHEELER had provided

legal services to IVIEWIT, including services regarding patent procurement and acted to coordinate such services both internally and with outside counsel, including RUBENSTEIN and JOAO, including times when they were misrepresented as PROSKAUER attorneys.

24. That PROSKAUER billed IVIEWIT for legal services related to corporate, patent, trademark and other work in a sum of approximately \$800,000.00.

25. That PROSKAUER billed IVIEWIT for legal service never performed, double-billed by the use of multiple counsel on the same issue, and systematically overcharged for services provided.

26. That summaries of the billing statements provided by PROSKAUER to IVIEWIT are attached hereto and made a part hereof as Exhibit "B".

27. That based on the over-billing by PROSKAUER, IVIEWIT paid a sum in of approximately \$500,000.00 plus together with a 2.5% interest in IVIEWIT, which sums and interest in IVIEWIT was received and accepted by PROSKAUER.

28. That WHEELER, UTLEY, RUBENSTEIN, JOAO and PROSKAUER, conspired to deprive IVIEWIT of its rights to the technologies developed by Bernstein by:

a) Transferring patents using Foley & Lardner so as to name UTLEY as the sole holder of multiple patents in his individual name and capacity when in fact they were and arose from the technologies developed by Bernstein and others and held by IVIEWIT prior to UTLEY's employment with IVIEWIT, and;

b) Upon discovery of the "lapses" by JOAO, that WHEELER and PROSKAUER referred the patent matters to WILLIAM DICK, of Foley & Lardner, who was also a close personal friend of UTLEY and who had been involved in the diversion of patents to UTLEY at Diamond Turf Products; and,

c) Failing to list proper inventors of the technologies based on improper legal advise that foreign inventors could not be listed until their immigration status was adjusted, resulting in the failure of the patents to include their rightful and lawful inventors and the payment by IVIEWIT for unnecessary immigration work; and,

d) Failing to ensure that the patent applications for the technologies, contained all necessary and pertinent information relevant to the technologies and as required by law; and,

e) Failing to secure trademarks and copyrights and failing to complete trademark and copyright work for the use of proprietary names of IVIEWIT and source code for the Technologies of IVIEWIT as intellectual property, and;

f) Allowing the infringement of patent rights of IVEIWIT and the intellectual property of IVIEWIT by other clients of PROSKAUER and WHEELER, and;

g) Aiding JOAO in filing patents for IVIEWIT intellectual property by intentionally withholding pertinent information from such patents and not filing same timely, so as to allow JOAO to apply for similar patents in his own name, both while acting as counsel for IVIEWIT and subsequently.

29. As a direct and proximate result of the actions of the Counter Defendant, Counter Plaintiffs have been damaged in a sum estimated to be greater than \$10,000,000,000.00, based on projections by Gerald Stanley, CEO of Real 3-D (a consortium of Lockheed, Silicone Graphics and Intel) as to the value of the technologies and their applications to current and future uses together with the loss of funding from Crossbow Ventures as a result of such conduct.

30. All conditions precedent to the bringing of this action have occurred or have been waived or excused.

COUNT I- LEGAL MALPRACTICE

31. This is an action for legal malpractice within the jurisdiction of this court.

32. Counter Plaintiff re-alleges and hereby incorporates that allegations of Paragraphs 1 through 30 as if fully set forth herein.

33. PROSKAUER employed by IVIEWIT for purposes of representing IVIEWIT to obtain multiple patents and oversee foreign filings for such technologies including the provisional filings for the technologies as described in Paragraph 11 above.

34. That pursuant to such employment, PROSKAUER owed a duty to ensure that the rights and interests of IVIEWIT were protected.

35. WHEELER, RUBENSTEIN, JOAO and PROSKAUER neglected that reasonable duty of care in the performance of legal services in that they:

a) Failed to take reasonable steps to ensure that the intellectual property of IVIEWIT was protected; and,

b) Failed to complete work regarding copyrights and trademarks; and,

c) Engaged in unnecessary and duplicate corporate and other work resulting in billing for unnecessary legal services believed to be in excess of \$400,000.00; and,

d) By redacting information from the billing statements regarding services provided so to as to give the appearance that the services provided by PROSKAUER were limited in nature, when in fact they involved various aspects of intellectual property protection; and,

e) By knowingly representing and agreeing to accept representation of

clients in conflict with the interests of IVIEWIT, without either consent or waiver by IVIEWIT.

36. That the negligent actions of PROSKAUER and its partners, WHEELER and RUBENSTEIN, resulted in and was the proximate cause of loss to IVIEWIT.

WHEREFORE, Counter Plaintiff demands judgement for damages against Defendant together with reasonable attorneys fees, court costs, interest and such other and further relief as this Court deems just and equitable.

COUNT II- CIVIL CONSPIRACY

37. This is an action for civil conspiracy within the jurisdiction of this court.

38. Counter Plaintiff re-alleges and hereby incorporates that allegations of Paragraphs 1 through 30 as if fully set forth herein.

39. Defendant, PROSKAUER and UTLEY, WHEELER, RUBENSTEIN and JOAO, jointly conspired to deprive the Counter Plaintiffs of their rights and interest in the Technology.

40. That UTLEY, WHEELER, RUBENSTEIN, JOAO and PROSKAUER with such intent, directed that certain patent rights be put in the name of UTLEY and/or that such patent rights were modified or negligently pursued so as to fail to provide protection of the intellectual property, resulting in the ability of other clients of WHEELER, RUBENSTEIN, JOAO and PROSKAUER to make use of such

technologies without being liable to IVIEWIT for royalties normally arising from such use.

41. That PROSKAUER, without either consent of the Board of Directors or proper documentation, transferred securities to Tiedemann/Prolow Investment Group, which entity was also referred by WHEELER, who acted as counsel for such unauthorized transaction.

42. That upon the discovery of the above-described events and conspiracy, IVIEWIT's lead investor, Crossbow Ventures, ceased its funding of IVIEWIT.

43. That Crossbow Ventures, which was a referral of WHEELER, took a security interest in the Technology under the guise of protecting IVIEWIT and its shareholders from the actions of UTLEY, based on the filing of an involuntary bankruptcy (which was later withdrawn), and as to WHEELER and PROSKAUER based on the instant law suit, when in fact such conduct was motivated by Crossbow's attempts to wrongfully detain the interests of IVIEWIT in the Technology. Such conduct, upon information and belief, was undertaken with the knowledge and assistance of WHEELER and PROSKAUER.

44. As a direct and proximate result of the conspiracy and acts of PROSKAUER, UTLEY, WHEELER, JOAO and RUBENSTEIN, the Counter Plaintiffs have been damaged.

WHEREFORE, Counter Plaintiffs demand judgement for damages against Defendant together with court costs, interest and such other and further relief as this Court deems just and equitable.

COUNT III- BREACH OF CONTRACT

45. This is an action for breach of contract within the jurisdiction of this Court.

46. Counter Plaintiff re-alleges and hereby incorporates that allegations of Paragraphs 1 through 30 as if fully set forth herein.

47. Defendant, PROSKAUER, breached the contract with Counter Plaintiff, IVIEWIT LLC by failing to provide services billed for pursuant to the billing statements presented to the Counter Plaintiffs and over-billing for services provided.

48. That such actions on the part of PROSKAUER constitute beaches of the contract by and between IVIEWIT LLC and PROSKAUER.

49. That as a direct and proximate result of such conduct on the part of PROSKAUER, IVIEWIT LLC has been damaged by overpayment to PROSKAUER and the failure of PROSKAUER to perform the contracted for legal services.

WHEREFORE, IVIEWIT demands judgement for damages against Counter Defendant together with court costs, interest and such other and further relief as this Court deems just and equitable.

**COUNT IV- TORTIOUS INTERFERENCE WITH AN ADVANTAGEOUS
BUSINESS RELATIONSHIP**

50. This is an action for tortious interference with an advantageous business relationship within the jurisdiction of this Court.

51. Counter Plaintiff re-alleges and hereby incorporates that allegations of Paragraphs 1 through 30 as if fully set forth herein.

52. Counter Plaintiff was engaged in negotiations of technology agreements with both Warner Bros. and AOL/Time Warner as to the possible use of the Technologies of the Counter Plaintiffs and investment in Counter Plaintiffs as a strategic partner.

53. That despite the prior representations of RUBENSTEIN, at a meeting held on or about November 1, 2000, by and between UTLEY, RUBENSTEIN and representatives of Warner Bros. as to the Technology of IVIEWIT and the efficacy, novelty and unique methodology of the Technology, RUBENSTEIN refused to subsequently make the same statements to representatives of AOL and Warner Bros., taking the position that since Warner Bros./AOL is "now a big client of Proskauer, I can't comment on the technologies of Iviewit." or words to that effect in response to inquiry from Warner Brother/AOL's counsel as to the status and condition of the pending patents on the intellectual property.

54. That RUBENSTEIN, having served as an advisor to the Board of Directors for IVIEWIT, was aware of the fact that at the time of the making of the statements set forth in Paragraph 50, above, IVIEWIT was in the midst of negotiations with AOL/Warner Bros. as to the possible funding of the operations of IVIEWIT in and sum of between \$10,000,000.00 and \$20,000,000.00.

55. Further, RUBENSTEIN as a partner of PROSKAUER, and despite his clear prior actions in representing the interests of IVIEWIT, refused to answer questions as to the enforcement of the Technology of IVIEWIT, with the intent and knowledge that such refusal would lead to the cessation of the business relationship by and between IVIEWIT and Warner Bros./AOL and other clients familiar with the Warner Bros./AOL technology group then in negotiations with IVIEWIT, including, but not limited to Sony Corporation, Paramount, MGM and Fox.

56. That the actions of RUBENSTEIN were and constituted an intentional and unjustified interference with the relationship by and between IVIEWIT and Warner Bros./AOL designed to harm such relationship and further motivated by the attempts to "cover-up" the conflict of interest in PROSKAUER's representation of both IVIEWIT and Warner Bros./AOL.

57. That indeed, as a direct and proximate result of the conduct of RUBENSTEIN, Warner Bros./AOL ceased business relations with IVIEWIT to the

damage and detriment of Counter Plaintiffs.

WHEREFORE, Counter Plaintiffs demand judgement for damages against Counter Defendant together with court costs, interest and such other and further relief as this Court deems just and equitable.

I HEREBY CERTIFY that a true and correct copy of the foregoing has been provided by U.S. Mail and fax transmission this 20th day of January, 2003 to: Christopher W. Prusaski, Esq., Proskauer Rose, LLP, 2255 Glades Road, Suite 340 W, Boca Raton, FL 33431.

SELZ & MUVDI SELZ, P.A.
214 Brazilian Avenue, Suite 220
Palm Beach, FL 33480
Tel: (561) 820-9409
Fax: (561) 833-9715

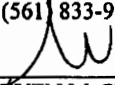
By: 

STÉVEN M. SELZ
FBN: 777420



EXHIBIT R



COMPANY REVENUE PROJECTIONS

Calculated Discount Rate:	12.00%				
	Year 1	Year 2	Year 3	Year 4	Year 5
Revenue Potential					
<i>Device OEM Licensing</i>	\$387,491,845	\$410,385,714	\$435,344,087	\$485,758,798	\$543,018,985
<i>Motion Picture Video on Demand ("VOD") Licensing</i>	4,260,793	4,778,426	5,648,251	7,151,662	9,707,205
<i>DVD Encoding/Replication</i>	383,471,325	430,058,359	508,342,628	643,649,599	873,648,447
<i>Appliances (copiers, printers, etc.)</i>	290,618,884	307,789,285	326,808,066	364,319,098	407,264,239
<i>Other Device OEM's (scanners, game boxes, e-books, etc.)</i>	96,872,961	102,596,428	108,836,022	121,439,699	135,754,746
<i>Delivery Systems (terrestrial, ISP, Wireless, etc.)</i>	387,491,845	0	0	0	0
<i>Medical Imaging and Devices</i>	116,247,554	123,115,714	130,603,226	145,727,639	162,905,696
<i>Wireless Devices</i>	271,244,292	287,270,000	304,740,861	340,031,159	380,113,290
<i>Enterprise Software</i>	191,735,663	215,029,179	254,171,314	321,824,799	436,824,224
<i>Internet (auctions, retail games, etc.)</i>	<u>191,735,663</u>	<u>215,029,179</u>	<u>254,171,314</u>	<u>321,824,799</u>	<u>436,824,224</u>
Present Value -- Total Revenue Potential	1,875,454,356	1,670,960,048	1,657,584,195	1,749,351,147	1,921,901,867
Present Value -- Cumulative Revenue Potential	<u>1,875,454,356</u>	<u>3,546,414,404</u>	<u>5,203,998,599</u>	<u>6,953,349,746</u>	<u>8,875,251,614</u>
Present Value -- Cum. Rev. Pot. Over 20-Year Patent Life	<u>\$17,353,552,076</u>				
Assume Percentage of Unsuccessful U.S. Patent Repair	\$6,802,592,414				
Assume Percentage of Forfeiting PCT Protection	<u>3,470,710,415</u>				
Cum. Potential Damages Over 20-Year Patent Life	<u>\$10,273,302,829</u>				



EXHIBIT S



Typical Video

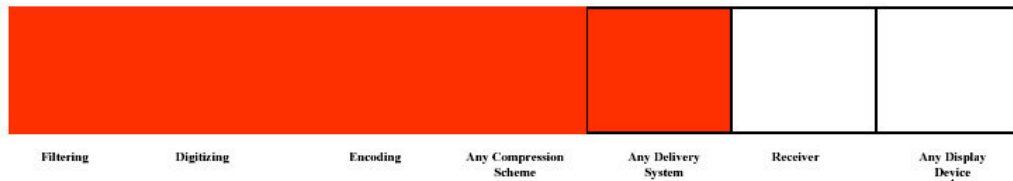
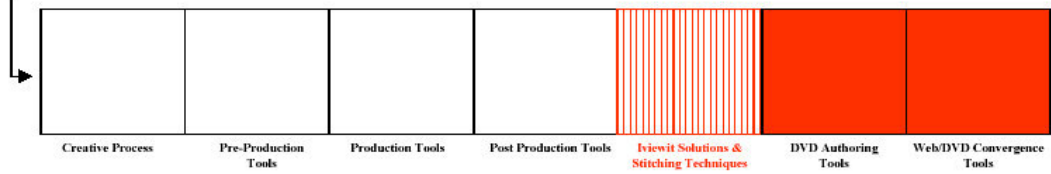

Key:  Better Enabled by Essential Iviewit Technology

- HDTV
- DTV
- Cable STB
- Satellite STB
- ADC STB
- DVD Players
- Digital Cameras/Camcorders
- PC

Proprietary & Confidential



MPEG 2 LICENSORS



BOSCH

Canon

COLUMBIA UNIVERSITY



FUJITSU



We bring good things to life.

GI General Instrument®

HITACHI

JVC



**Philips
Electronics**



**Sharp
Corporation**

SONY



TOSHIBA



MPEG 2 LICENSEES

1. AAV Australia Pty Ltd
2. Access Media S.P.A.
3. Action Electronics Co., Ltd.
4. Action Industries (M) SDN. BHD.
5. Acoustic Systems, Inc.
6. ADI Corporation
7. Adspace Networks, Inc.
8. AEON Digital Corp
9. Aeroflex Lintek, Inc.
10. AgileTV Corporation
11. Ahead Software AG
12. Ahead Software Incorporated
13. Airshow, Inc.
14. Aiwa Co., Ltd.
15. Alcatel
16. Alco Digital Devices Limited
17. Alcorn McBride, Inc.
18. Alpine Electronics, Inc.
19. AMLOGIC, Inc.
20. Amnis Systems Inc.
21. Amphion Semiconductor (Asia) Limited
22. Amphion Semiconductor Inc.
23. Amphion Semiconductor Limited
24. Amstrad plc
25. AnalyTotal Ltd.
26. Apex Digital, Inc.
27. Aplus Technics Co., Ltd.
28. Apollo Electronics Group Limited
29. Apple Computer, Inc.
30. A&R Cambridge Limited
31. ASC Audio Video Corporation
32. ASE Technologies, Inc.
33. Astrodesign, Inc.
34. ATL Electronics (M) Sdn. Bhd.
35. ATL Hong Kong Limited
36. ATLM Taiwan Inc.
37. Audiovox Electronics Corporation
38. Axis Communications AB
39. Bang & Olufsen A/S
40. BarcoNet n.v.
41. Bashaw, Sean
42. Beautiful Enterprise Co., Ltd
43. BennArts
44. B.H.A. Corporation
45. Billionton Systems Inc.
46. BitCtrl Systems GmbH
47. Blonder Tongue Laboratories, Inc.



48. Bose Corporation
49. Broadcast Sports Inc.
50. Broadcast Technology Limited
51. B.U.G., Inc.
52. Canon Inc.
53. Casio Computer Co., Ltd.
54. C-Cube Microsystems, Inc.
55. CD Linja, Digital Communication Media Oy
56. CellStack Systems Ltd
57. CenDyne, Inc.
58. Cequadrat (USA), Inc.
59. CGI Verwaltungsgesellschaft mbH
60. Cheertek Inc.
61. Chumiecki, Tomasz J.
62. Cine Magnetics Video & Digital Laboratories
63. Cinram France, S.A.
64. Cinram Inc.
65. Cinram International Inc.
66. Cinram Latinoamericana S.A. de C.V.
67. Cinram Nederland B.V.
68. Cinram Optical Discs, S.A.
69. Cinram U.K. Ltd.
70. Cirrus Logic Inc.
71. CIS Technology Inc.
72. Cisco Australia
73. Cisco Canada
74. Cisco Japan
75. Cisco Systems BV and Cisco Systems Capital BV
76. Cisco Systems Capital
77. Cisco Systems, Inc.
78. Clarion Co., Ltd.
79. Codex Novus, Inc.
80. Columbia Digital Media, Inc.
81. Compaq Computer Corporation
82. Computer Modules, Inc.
83. Cornet Technology, Inc.
84. Coull Limited
85. Custom Technology Corporation
86. CyberLink Corp.
87. Cyrus Electronics Ltd.
88. Daewoo Electronics Corporation
89. Dai Hwa Industrial Co., Ltd.
90. Darim Vision Co.
91. Data Becker GmbH & Co. KG
92. Dataton Utvecklings AB
93. DCM Danmark, Digital Communication Media Aps
94. DCM Sweden, Digital Communication Media AB
95. DCM TriData, Digital Communication Media AB
96. DEFINITION Consultants Ltd.
97. Delco Electronics Corporation
98. DELL Products, L.P.
99. Denon Digital Industries
100. Denon Electronic GmbH
101. DENON, Ltd.
102. Digatron Industrie-Elektronik



103. DigiOn, Inc.
104. Digital Audio Disc Corporation
105. Digital Communication Media AB
106. Digital Media Technologies, Ltd.
107. Digital Transmission Equipment
108. Digital Video Services
109. Digital Vision AB
110. Digitalfabriken Göteborg, Digital Communication Media AB
111. Diotech SMT Product Co., Ltd.
112. Direct Broadcasting Satellite Corporation
113. DirectSat Corporation
114. Disctronics Manufacturing (UK) Limited
115. Dish Entertainment Corporation
116. Dish Factory Direct Corporation
117. Dish, Ltd.
118. DIVA Systems Corporation
119. DivXNetworks, Inc. (DIVX)
120. Doremi Labs, Inc.
121. Drastic Technologies Ltd.
122. DResearch Digital Media Systems GmbH
123. D.S. Corporation
124. DVD Retail Ltd. (Mirror)
125. DX Antenna Co., Ltd.
126. Eastern Asia Technology Limited
127. Eastwin Technology Inc
128. Eastwin Technology Industries (Hui Yang) Co. Ltd.
129. Easy Systems Japan Ltd.
130. Echonet Business Network, Inc.
131. Echosphere Corporation
132. Echosphere De Mexico S.De R.L. De. C.V.
133. EchoStar Acceptance Corporation
134. EchoStar Communications Corporation
135. EchoStar DBS Corporation
136. EchoStar Indonesia Corporation
137. EchoStar International Corporation
138. EchoStar International (Maritius Limited)
139. EchoStar KuX Corporation
140. EchoStar Manufacturing and Distribution Private Limited (India)
141. EchoStar North America Corporation
142. EchoStar PAC Corporation
143. EchoStar Real Estate Corporation
144. EchoStar Real Estate Corporation II
145. EchoStar Satellite Broadcasting Corporation
146. EchoStar Satellite Corporation
147. EchoStar Space Corporation
148. EchoStar Technology, Inc.
149. ECM Systems Ltd.
150. EG Technology, Inc.
151. ek3 Technologies Inc.
152. Elma Ingénierie Informatique



153. EMI Global, Inc.
154. EMI Operations Italy S.p.A.
155. EMI Recorded Music
156. Enlight Corporation
157. Enseo, Inc.
158. ERDAS, Inc.
159. E-Sat, Inc.
160. E-Soft Computer Co., Ltd.
161. ESBuy.com
162. ESDG Konsult AB
163. Etronics Corporation
164. EuroNimbus S.A.
165. Exatel Visual Systems, Inc.
166. FineArch Inc.
167. First Virtual Communications, Inc.
168. Flextracker Sdn. Bhd.
169. Formation, Inc.
170. Frey Technologies, LLC
171. Fujitsu Limited
172. Fujitsu Siemens Computers
173. Fujitsu Siemens Computers AB
174. Fujitsu Siemens Computers AG
175. Fujitsu Siemens Computers AS
176. Fujitsu Siemens Computers A/S
177. Fujitsu Siemens Computers BV
178. Fujitsu Siemens Computers d.d.
179. Fujitsu Siemens Computers GmbH
180. Fujitsu Siemens Computers KFT
181. Fujitsu Siemens Computers Ltd
182. Fujitsu Siemens Computers Oy
183. Fujitsu Siemens Computers (Pty)
Ltd
184. Fujitsu Siemens Computers s.r.o.
185. Fujitsu Siemens Computers SA
186. Fujitsu Siemens Computers SL
187. Fujitsu Siemens Computers SP.
z.o.o.
188. Fujitsu Siemens Computers SpA
189. FUJITSU TEN LIMITED
190. Funai Electric Co., Ltd.
191. Fusic Electronics Ltd
192. Gateway, Inc.
193. GBM Advanced Technology
International Inc.
194. General Instrument Corporation
195. Generic Media Inc.
196. Global Web TV, Inc.
197. GPX, Inc.
198. Grass Valley (US) Inc.
199. Great Wall Digitech Limited
200. GRUNDIG AG
201. Gyro Media AB
202. Gyro Soft AB
203. Harman International Industries
204. Harmonic Inc.
205. Heim Systems GmbH
206. Heuris Logic Incorporated
207. Hewlett-Packard Company
208. Hibino Data-com Co., Ltd.
209. High Speed Video Inc.
210. Hitachi Business Solutions Co., Ltd.
211. Hitachi Communication Systems,



212. Hitachi Electronics Engineering Co., Ltd.
213. Hitachi Electronics Products (Malaysia) Sdn. Bhd.
214. Hitachi Engineering Co., Ltd.
215. Hitachi Home Electronics (America), Inc.
216. Hitachi Home Electronics (Europe), Ltd.
217. Hitachi Hometec, Ltd.
218. Hitachi Information Systems, Ltd.
219. Hitachi Kokusai Electric Inc.
220. Hitachi, Ltd.
221. Hitachi SK Social System Co., Ltd.
222. Hitachi Software Engineering America, Ltd.
223. Hitachi Software Engineering Co., Ltd.
224. Hitachi Software Engineering Europe S.A.
225. Hitachi Software Global Technology, Ltd.
226. Hitachi Technology (Taiwan) Ltd.
227. Hitachi Telecom Technologies, Ltd.
228. Hong Kong Tohei E.M.C. Co., Ltd.
229. Houston Tracker Systems, Inc.
230. HT Ventures, Inc.
231. Hughes Network Systems
232. Hui Yang Eastway Electronics Co., Ltd
233. HUMAX Co., Ltd.
234. HUMAX Electronic Ltd.
235. Hyunwoo McPlus Co., Ltd.
236. IBE, Inc.
237. Ikegami Tsushinki Co., Ltd.
238. Imedia Corporation
239. iMPath Networks, Inc.
240. Independent Masters Ltd.
241. Indoor Outdoor Entertainment, S.A.
242. Innobits AB
243. Innovision Limited
244. Institut fuer Rundfunktechnik GmbH
245. International Antex, Inc.
246. International Fiber Systems, Inc.
247. International Image Services Corp. doing business as Sonic Foundry Media Services
248. International PADI, Inc.
249. Interra Digital Video Technologies
250. InterVideo, Inc.
251. Inventec Electronics (M) Sdn. Bhd.
252. iZotope, Inc.
253. Japan Communication Equipment Co., Ltd.
254. Japan Digital Laboratory Co., Ltd.
255. Japan Radio Co., Ltd.
256. Japan Wave Inc.
257. Jaton Computer Co., Ltd.



258. JEPRO Co., Ltd.
259. J Hepple, Incorporated
260. Jin Shen Long Electronics (Shen Zhen) Co., Ltd
261. Kabushikigaisya Fujiyadenki Seisakusyo
262. Kalyani Sharp India Limited
263. Kent World Co., Ltd
264. Kenway Technology Industries (Hui Yang) Co. Ltd.
265. Kenwood Corporation
266. Kinki General Service Co., Ltd.
267. Koninklijke Philips Electronics N.V.
268. Krell Industries, Inc.
269. KUME Electric Corporation
270. L-3 Communications Systems West
271. Lawrence Livermore National Laboratory
272. Leitch Europe Limited
273. Leitch Incorporated
274. Leitch Technology Corporation
275. Leitch Technology International Inc.
276. LG Electronics Inc.
277. LifeScience Media
278. Lindows.com, Inc.
279. Linear Systems Ltd.
280. Link Research Ltd.
281. Linn Products Limited
282. LOEWE OPTA GmbH
283. Logic Innovations, Inc.
284. Logitec Corporation
285. LOGOS Ljud och Bild Produktion AB
286. LSI Logic Corporation
287. LSI Systems Inc.
288. Lu Kee Electronic Company Limited
289. LuxSonor Semiconductors, Inc.
290. MacroSystem Digital Video AG
291. MacroSystem France S.A.S.
292. MacroSystem Schweiz AG
293. MacroSystem US, Inc.
294. Madrigal Audio Laboratories, Inc.
295. MainConcept GmbH
296. MainConcept LLC
297. MANSEI Corporation
298. Manufacturing and Test Co., Inc. dba MATCO
299. Manystreams, Inc.
300. Manzanita Systems
301. Marantz Japan, Inc.
302. Marconi Communications, Inc.
303. Mars Technologies, Inc.
304. Maspro Denkoh Corporation
305. Matsushita Electric Industrial Co., Ltd.
306. Matsushita Electric (Taiwan) Co., Ltd.
307. Matsushita Electric (U.K.) Ltd.
308. Matsushita Electronics Corporation
309. Matsushita-Kotobuki Electronics Industries, Ltd.
310. Matsushita Kotobuki Electronics



311. Matsushita Kotobuki Electronics Sales of America, LLC.
312. Matsushita Television and Network Systems Company, a division of Matsushita Electric Corporation of America
313. MAX Internet Communications, Inc.
314. MAXpc Technologies, Inc.
315. Media Compression LLC
316. MediaWare Solutions Pty Ltd.
317. MedioStream, Inc.
318. MELCO INC.
319. Memory-Tech Corporation
320. Meridian Audio Limited
321. Metatec International, Inc.
322. Metz-Werke GmbH & Co KG
323. MicronPC, LLC
324. Micron Government Computer Systems, LLC
325. Microtune (Texas), L.P.
326. MidStream Technologies, Inc.
327. Minerva Networks, Inc.
328. Mintek Digital Inc.
329. MIT Media Lab
330. Mitsubishi Electric Corporation
331. Mokoh & Associates, Inc.
332. Moonlight Cordless Ltd.
333. Motorola
334. MPO
335. MRT Technology LLC
336. Multimedia Technologies, Inc.
337. muvee Technologies Pte. Ltd.
338. NagraStar LLC
339. Namsung Corporation
340. Nanjing Sharp Electronics Co., Ltd.
341. National Semiconductor Corporation
342. NCR Corporation
343. NCT AG
344. NDS Limited
345. Neil Galton Consultancy Ltd
346. Neos Interactive Ltd.
347. NewSoft Technology Corporation
348. Next Level Communications, L.P.
349. NIHON COMPUTER Co., Ltd.
350. Nihon Digital Consumer Electronics Corporation
351. Nikko Denki Tsushin Corporation
352. Nimbus Manufacturing, Inc.
353. Nimbus Manufacturing (UK) Ltd.
354. Nokia Corporation by and through it's business unit
Nokia Home Communications
355. Norcent Technology Inc.
356. NTK Computer Inc.
357. NTT Advanced Technology Corporation
358. NTT Electronics Corporation
359. Nuon Semiconductor, Inc.
360. Oak Technology, Inc.



361. Oki Electric Industry Co., Ltd.
362. ONKYO CORPORATION
363. ONKYO ELECTRONICS CORPORATION
364. ONKYO EUROPE ELECTRONICS GmbH
365. ONKYO INDIA PVT. LTD
366. ONKYO (MALAYSIA) SDN. BHD
367. ONKYO U.S.A. CORPORATION
368. Optibase B.V.
369. Optibase Europe
370. Optibase Inc.
371. OPTIBASE LTD.
372. Optical Experts Manufacturing, Inc. (OEM)
373. Orion America, Inc.
374. Orion Electric Co., Ltd.
375. Orion Electric (U.K.) Ltd.
376. PAC Interactive Technology, Inc.
377. P. Guerra s.r.l.
378. Pace Micro Technology PLC
379. Panasonic AVC Networks Germany GmbH
380. Panasonic AVC Networks Singapore Pte Ltd
381. Panasonic Communications Co., Ltd.
382. Panasonic Digital Network Serve Inc.
383. Panasonic Disc Manufacturing Corporation of America
384. Panasonic Mobile Communications Co., Ltd.
385. Pegasys Inc.
386. Photodex Corporation
387. Pioneer Corporation
388. Pioneer Electronics Manufacturing (Shanghai) Co., Ltd.
389. Pioneer Electronics Technology (U.K.) Ltd.
390. Pioneer Technology (Malaysia) SDN, BHD
391. Pioneer Video Corporation
392. Pioneer Video Manufacturing Inc.
393. Plat'C2, Inc.
394. Popwire Stockholm AB
395. Pozzoli S.p.A
396. Private Eye Productions
397. Pro-G Group Inc.
398. Pro-G International Holdings
399. Proton Co., Ltd. Softboat Division Company
400. Provideo Multimedia Co. Ltd.
401. PT Matsushita Kotobuki Electronics Industries Indonesia
402. Pure Motion Ltd
403. Questin' Studios
404. Radyne ComStream
405. Regency Recordings Pty Ltd.
406. Research Systems, Inc.
407. Rohde & Schwarz GmbH & Co. KG
408. Roxio ApS



409. Roxio CI Ltd.
410. Roxio GmbH & Co. KG
411. Roxio, Inc.
412. Roxio International B.V.
413. Roxio Japan Inc.
414. S.A.D. GmbH
415. S. Anbu Ezhilan
416. Salent Technologies Ltd.
417. Sampo Corporation
418. Samsung Electronics Co., Ltd.
419. SANYO Electric Co., Ltd.
420. Sanyo Laser Products, Inc.
421. SANYO Manufacturing Corporation
422. SANYO Technosound Co., Ltd.
423. Sasken Communication Technologies Limited
424. Satellite Source, Inc.
425. Satrec Mauritius Limited
426. Scheidt & Bachmann GmbH
427. sci-worx GmbH
428. Science Applications International Corporation
429. Scientific-Atlanta, Inc.
430. Scopus Network Technologies Ltd.
431. sedima AG
432. Sensoray Company, Inc.
433. Sensory Science Corporation
434. Shanghai Far Year Technology Co., Ltd.
435. Sharp Corporation
436. Sharp Electronica Espana S.A
437. Sharp Electronica Mexico S.A. de C.V.
438. Sharp Manufacturing Company of America
439. Sharp Manufacturing Company of U.K.
440. Sharp Manufacturing Corporation (M) Sdn. Bhd.
441. Sharp-Roxy Appliances Corporation (M) Sdn. Bhd.
442. Sharp-Roxy Electronics Corporation (M) Sdn. Bhd.
443. Sharp Thebnakorn Manufacturing
444. Shenzhen Action Electronics Co., Ltd.
445. Shenzhen Kaixinda Electronics Co. Ltd.
446. Shenzhen Landel Electronics Tech. Co., Ltd.
447. Shin Won Industry Co., Ltd.
448. Shinsonic Multi-Media, Inc.
449. Silicon Construction Sweden AB
450. Simflex Software
451. SkyStream Networks Inc.
452. S.N.A. (Société Nouvelle Aréacem)
453. Snell & Wilcox Limited
454. Sonic Foundry, Inc.
455. Sonic Foundry Media Services, Inc.
456. Sonic Foundry Systems Group, Inc.
457. Sonic Solutions
458. Sonista, Inc.



459. Sonopress Iber-Memory, S.A.,
Spain
460. Sonopress, Inc., USA
461. Sonopress Ireland Limited
462. Sonopress Mexico Una division de
BMG Entertainment Mexico S.A. de
C.V.
463. Sonopress Pan Asia Ltd.
464. Sonopress Produktionsgesellschaft
für Ton-und Informationsträger
465. Sonopress Rimo Indústria e
Comércio Fonográfica Ltda
466. Sonopress Singapore PTE LTD
467. Sony Computer Entertainment Inc.
468. Sony Corporation
469. Sony DADC Austria AG
470. Sony Electronics Inc.
471. Sony Music Entertainment (Hong
Kong) Ltd.
472. Sony Music Entertainment (Japan)
Inc.
473. Sony Pictures Digital Inc.
474. Sony Service Center (Europe) NV
475. Sony United Kingdom, Ltd.
476. Sord Computer Corporation
477. Sorenson Media, Inc.
478. Spectaculaire!
479. Sports Training Media
480. S & T Systemtechnik GmbH
481. Standard Communications Corp.
482. Starlight Video Limited
483. Star Video Duplicating
484. Stebbing Recording Centre Ltd
485. Strategy & Technology Ltd.
486. Stream Machine Company
487. Sumitomo Electric Industries, Ltd.
488. Sunimage Studios Inc.
489. TAG McLaren Audio Limited
490. TAKT Kwiatkowski i Miadzel sp. j.
491. Tandberg Television ASA
492. Tatung Co.
493. TDK Electronics Corporation
494. TEAC Corporation
495. TEAC DEUTSCHLAND GmbH
496. TEAC SYSTEM CREATE
CORPORATION
497. Technicolor Disc Services
Corporation
498. Technicolor Home Entertainment
Services Ireland Ltd.
499. Technicolor Mexicana, S. de RL de
CV
500. Technicolor Pty Ltd.
501. Technicolor Videocassette, Inc.
502. TechniSat Digital GmbH
503. TechnoTrend AG
504. Techsan I&C Co., Ltd.
505. Tekniche Limited
506. Tektronix Cambridge Limited
507. Tektronix, Inc.
508. Telecom Kiki, Ltd.
509. Teledac Inc.



510. Teleview
511. Terr, LLC dba 321 Studios
512. The Mireth Technology Corporation
513. THOMSON
514. THOMSON Broadband UK Ltd.
515. THOMSON Digital Europe
516. THOMSON multimedia Asia Pacific Pte Ltd.
517. THOMSON multimedia Hong Kong Ltd.
518. THOMSON multimedia Inc.
519. THOMSON multimedia Operations (Thailand) Co. Ltd.
520. THOMSON multimedia Polska Sp. Z o.o.
521. THOMSON Sales Europe S.A.
522. THOMSON Television Angers S.A.
523. THOMSON TUBES & DISPLAYS S.A.
524. [Time Warner Inc.](#)
525. TiVo, Inc.
526. Tonic Digital Products Limited
527. Toppan Printing Co., Ltd.
528. Toshiba America Information Systems, Inc.
529. Toshiba Computer Systems (Shanghai) Co., Ltd.
530. Toshiba Corporation
531. Toshiba Europe GmbH
532. Toshiba Information Systems (UK) Limited
533. TOSHIBA TEC CORPORATION
534. TOSHIBA VIDEO PRODUCTS PTE LTD
535. Total Technology Co. Ltd.
536. TOTTORI ONKYO CORPORATION
537. Tottori SANYO Electric Co., Ltd.
538. Trilogic
539. Troll Technology Corporation
540. TTirem, Inc. dba Meritt Electronics
541. UEC Technologies (Pty) Ltd.
542. UnLimiter Limited
543. UP Technology Co., Ltd.
544. U.S. Philips Corporation
545. VBrick Systems, Inc.
546. VCS Video Communication Systems AG
547. Vela Research LP
548. Vestel Komunikasyon San. Tic. A. S.
549. Victor Company of Japan, Limited
550. VideoTele.com, Inc.
551. Visteon Corporation
552. VOB Computersysteme GmbH
553. V.T.V. NV
554. Welton Electronics Limited
555. Wescam Europe Limited
556. Wescam Inc.
557. Wescam Incorporated
558. Wescam LLC
559. Wescam Sonoma Inc.
560. Wiagra
561. Winbond Electronics Corp.



- 562. WIS Technologies, Inc.
- 563. Womble Multimedia, Inc.
- 564. World Electric (Thailand) Ltd.
- 565. Wuxi Multimedia Limited
- 566. Ya Bang Industrial Co., Ltd.
- 567. Yamaha Corporation
- 568. Yamaha Electronics Manufacturing (M) SDN.BDH.
- 569. Yanion Company Limited
- 570. Yung Fu Electrical Appliances Corp., Ltd.
- 571. Zapex Technologies, Inc.
- 572. ZapMedia.com, Inc.
- 573. Zenith Electronics Corporation
- 574. Zirbes, Kelly
- 575. ZOO Digital Group plc



EXHIBIT T



LETTER OF MR. WHEELER TO ROSSMAN

APR 26 1999 18:04 FR PROSKAUER ROSE

561 241 7145 TO 2410071#

P.02/02

PROSKAUER ROSE LLP

2255 Glades Road
Suite 340 West
Boca Raton, FL 33431-7360
Telephone 561.241.7400
Elsewhere in Florida
800.432.7746
Fax 561.241.7145

NEW YORK
LOS ANGELES
WASHINGTON
NEWARK
PARIS

Christopher C. Wheeler
Member of the Firm

Direct Dial 561.995.4702
cwheeler@proskauer.com

April 26, 1999

Mr. Richard Rosman
Lewinter and Rosman
16255 Ventura Blvd., Suite 600
Encino, CA 91436

Re: iviewit, Inc.

Dear Richard:

Under separate cover I have forwarded you a revised Confidentiality Agreement.

As you know we have undertaken representation of iviewit, Inc. ("iviewit") and are helping them coordinate their corporate and intellectual property matters. In that regard, we have reviewed their technology and procured patent counsel for them. We believe the iviewit technology is far superior to anything presently available with which we are familiar. iviewit has filed a provisional patent application on a method for providing enhanced digital images on telecommunications networks. We are advised by patent counsel that the process appears novel and may be protected by the patent laws. While in all matters of this sort, it is far to early to make any final pronouncements, we do believe that there is an extremely good prospect that iviewit will protect their process which is novel and superior to any other format which we have seen.

Very truly yours,

Christopher C. Wheeler

CCW/gb

0894/40017-001 BALIB1/227137 v1

04/22/99 03:57 PM (2743)



LETTER OF MR. WHEELER TO GEMAL SEEDE

JUN 10 1999 11:37 FR PROSKAUER ROSE

561 241 5288 TO 41744708

P.02/06

PROSKAUER ROSE LLP

2285 Glades Road
Suite 340 West
Boca Raton, FL 33431-7360
Telephone 561.241.7400
Elsewhere in Florida
800.432.7746
Fax 561.241.7145

NEW YORK
LOS ANGELES
WASHINGTON
MIAMI
PARIS

Christopher C. Wheeler
Member of the Firm
Direct Dial 561.995.4702
cwheeler@proskauer.com

June 9, 1999

Via Fax

Mr. Gemal Seede
Nercubator
30 W. Green Street
Pasadena, CA 91105

Dear Mr. Seede:

At the request of Alan Epstein, I am forwarding the enclosed two Confidentiality Agreements to you. I would appreciate your signing and returning them to me.

We have undertaken representation of iVIEWIT, Inc. ("iVIEWIT") and are helping them coordinate their corporate and intellectual property matters. In that regard, we have reviewed their technology and procured patent counsel for them. We believe the iVIEWIT technology is far superior to anything presently available with which we are familiar. iVIEWIT has filed a provisional patent application on a method for providing enhanced digital images on telecommunications networks. We are advised by patent counsel that the process appears novel and may be protected by the patent laws. While in all matters of this sort, it is far too early to make any final pronouncements. We do believe that there is an extremely good prospect that iVIEWIT will protect their process which is novel and superior to any other format which we have seen.

Sincerely,

Christopher C. Wheeler

CCW/gb

cc: Alan J. Epstein - Via Fax

0894/40017-001 BRUB1/232305 v1

06/09/99 08:52 PM 127431



DEPOSITION OF MR. WHEELER STATING RESPONDENT DID NO PATENT WORK

7 Q. How about Ken Rubenstein?
8 A. I don't believe Ken --
9 MR. TRIGGS: Object to form. What's your
10 question about Ken Rubenstein?
11 Q. Was he involved in the patent process or
12 any of the proceedings or services provided with
13 regard to the patents?
14 MR. TRIGGS: Object to the form.
15 A. No. He - he was -- First of all, I don't
16 believe he worked -- I believe he worked at Proskauer
17 at the time and not at Meltzer - Meltzer Lippy. Is
18 that the name of the firm? And secondly, he - his
19 involvement was only to -- He - he - he obviously is
20 a - one of our patent contacts and his - his --

ADMISSION BY MR. WHEELER OF CONSULTING WITH RESPONDENT⁵⁴

Iviewit. In that capacity, Mr. Wheeler periodically conferred with patent counsel, Iviewit representatives, and even Mr. Rubenstein in limited instances. Faced with this reality, Mr. Bernstein alleges – again without any support – that Proskauer must have tampered with or altered its billing statements. There is no truth to this assertion. We provided you with a complete set of our billing records in our April 7, 2003 submission. Should you have any questions whatsoever regarding our statements, please feel free to ask.

⁵⁴ *Supra* Note 31 at 5.



DEPOSITION OF MR. WHEELER STATING WHAT RESPONDENT NEEDS TO DETERMINE THE PATENTABILITY OF THE COMPANY S INVENTIONS

20 Q. And it says specifically, and I quote,
21 since there seems to be some confusion as to what Ken
22 needs in order to determine the patentability of your
23 process?

24 A. Right.

25 Q. I'm arranging a conference call between
1 you, me and Ken in which we can discuss it.

2 A. Right.

ELECTRONIC MAIL MESSAGE OF MR. WHEELER ARRANGING TELECONFERENCE WITH RESPONDENT TO DISCUSS HIS OVERSIGHT OF THE PATENT PROSECUTION PROCESS

-----Original Message-----

From: Christopher Wheeler [mailto:CWHEELER@proskauer.com]

Sent: Friday, May 28, 1999 6:26 AM

To: alps@netline.net

Subject: Tuesday Meeting

** High Priority **

Eliot,

Ken Rubenstein will be available on Tuesday morning sometime between 8:30 and 9 to discuss the patents. We can conference him in after we start with Joao and ourselves. Have you already made sure that Joao will be available? Please advise immediately.

Best regards,

Chris



EXHIBIT U



DEPOSITION OF MR. UTLEY STATING THAT HE NEVER DISCUSSED THE COMPANY S INVENTIONS WITH RESPONDENT

23 THE WITNESS: But, like I say, I do
24 recall that I had one conversation with Ken
25 Rubenstein, but I absolutely do not recall the

Pat Carl & Associates (763)591-0535 or (800)591-9PCA (722)

Proskauer Rose, et al. vs Iviewit.Com, Inc., et al. 8/22/02

1 content of the conversation. It was not anything 141
2 that was material to what Iviewit did.
3 By MR. SELZ:

DEPOSITION OF MR. UTLEY STATING THAT HE HAD CONVERSATION WITH RESPONDENT TO APPRISE HIM OF THE STATUS OF THE COMPANY S PATENT PROSECUTION PROCESS PRIOR TO A CONTRACT WITH WARNER BROS.

Q. Did you ever have any discussions
with Mr. Rubenstein with regard to the
intellectual properties of Iviewit?
A. I can recall that I had discussion
that briefed him on where we were in terms of
filing patents covering the Iviewit IP, but it

Pat Carl & Associates (763)591-0535 or (800)591-9PCA (722)



was a general discussion.

Q. And what was the purpose of that discussion with Mr. Rubenstein?

A. I believe that that was to inform him of where Iviewit was relative to its IP because there was a proposed contact between the Warner Brothers representative on the patent pool and Mr. Rubenstein for the purpose of suggesting that the Iviewit technology was, had some substance.

Q. Had some what?

A. Substance.

Q. Substance, okay. But it wasn't anything more in depth than just advising him that it was in the process of --

A. It was a single phone call which I made to him.

Q. And about what date was that, if you can recall?

A. Oh, it was in late 2000, fourth quarter 2000.

Q. Did you ever have any other conversations with Mr. Rubenstein, other than the one you've already described?

A. I don't recall any other

conversations, no.

MR. UTLEY REITERATES THAT RESPONDENT HAD NO ROLE

9 THE WITNESS: Well, Rubenstein and
10 Mr. Wheeler, I'll repeat, had nothing to do with
11 the patents and therefore, I object to them being
12 included in the question.

MR. UTLEY AGAIN STATES RESPONDENT HAD NO ROLE

3 Q. Well, let's go to my next question
4 on this whole thing, and that is, with regard to,
5 with regard to the approval by the board of
6 directors, we've talked prior about the board of
7 directors and Ken Rubenstein, was Ken
8 Rubenstein -- you've previously stated that he
9 didn't have any role with regard to the company,
10 no active role?

11 A. That's correct.

12 Q. And I hate to bounce back and forth
13 to you about this, he was never, like, an advisor
14 or consultant or anything like that; he was just
15 someone who was Proskauer Rose's person who did
16 work on IP?

17 A. Yeah, I can't speak to the
18 discussions that may have taken place between
19 Mr. Wheeler and Mr. Rubenstein, but --

20 Q. I'm not asking you to. I'm just
21 saying from what you know because obviously this
22 deposition testimony is given on your own
23 personal knowledge.

24 A. Yes. He played no active role in
25 the company other than having directed the



MR. UTLEY, REVERSING COURSE, AND NAMING RESPONDENT AS ADVISOR

From: Brian G. Utley [brian@iviewit.com]
Sent: Wednesday, April 18, 2001 8:17 AM
To: Eliot I. Bernstein; 'simon@adelphia.net'; 'kanderson@myCFO.com'; 'dg_kane@msn.com'; 'glewin@goldsteinlewin.com'; 'hankpow@gate.net'; 'bprolow@tiedemannfunds.com'; Maurice Buchsbaum
Cc: 'Christopher C. Wheeler (E-mail)'
Subject: RE: Minutes of the Board Meeting of April 14, 2001

I was advised by Proskauer Rose that anyone who was in an active due diligence stage and who was reviewing our intellectual property as part of that due diligence should receive a copy of the examiners opinion. Therefore the opinion was forwarded to the same people who have received copies of the patent filings namely, Warner Brothers and Irell & Manella. Ken Rubenstein, as our advisor, was also copied. Your father suggested that, because of the importance of our intellectual property, our own Board of Directors should be aware of the current status of our applications. With respect to Irell & Manella, it is quite likely that we will need to engage them or some other alternative counsel in order to respond to the opinion. I have a copy of Alvear's book if you need it.

With respect to processing the requested demo tape, you may recall that you actually set the standard by processing similar demo material for igallery some time ago. This job was handled discreetly and the 18 year old employee referred to had already been released from the business. We are not in the business of processing adult entertainment material and have consistently represented this position. I trust this clarifies both matters.
Brian

MR. UTLEY, REVERSING COURSE AGAIN, ASKING WHAT ROLE TO PROVIDE FOR RESPONDENT

-----Original Message-----
From: Brian G. Utley [mailto:brian@iviewit.com] On Behalf Of Brian
Sent: Thursday, January 13, 2000 9:33 AM
To: 'cwheeler@proskauer.com'; 'ccwhlaw@aol.com'
Subject: Business Plan

Your name and Ken Rubenstein's name are proposed as members of an iviewit advisory board. Does this give you a problem?
Brian



**MR. UTLEY EXPRESSLY PASSES PATENT INFORMATION FOR
RESPONDENT S REVIEW**

April 16, 2001

Kenneth Rubenstein
Proskauer Rose LLP
1585 Broadway
New York, NY 10036

Dear Ken,

Re: iviewit Video Patent Applications

Ken, for your information, we have received the attached PCT opinion relative to the iviewit patent applications.

If you have any comment or questions do not hesitate to call me.

Yours truly,

Brian Utley
President

BU/bmb

cc: Chris Wheeler



EXHIBIT V



ELECTRONIC MAIL MESSAGE OF MR. KASSER ALLEGING MR. HERSH, FORMER CHIEF FINANCIAL OFFICER OF THE COMPANY, WITH FRAUD PERTAINING TO REVENUE ACCOUNTS OF THE COMPANY

Eliot,

Here is the information I promised you this afternoon. Attached are the Goldstein Lewin compiled financial statements as of December 31, 2000, the detail of the income accounts and the Doyle invoice. The income account detail (three accounts) totals \$248,070.75, consistent with the \$248,071 revenue number in the financial statements. As you can see, without the Doyle number the Gross Profit for the year would have been well under \$100,000.

They fattened the number and palmed it off on Lewin. These financial statements were submitted to Crossbow. They may have also been given to Wachovia and others. I do not have the purchase order. Please see if it is with the papers recovered from Larry.

I tried last spring to locate Doyle Occupational. The phone number in our records is not valid. There is a Doyle Occupational Health Clinic in Nashville, but it is not related to this group. There is a Jason Speaks listed in the Nashville phone directory, but last spring he did not return my call.

Bill

iviewit.com, Inc.
2255 Glades Road, Suite 337W
Boca Raton, FL 33431

Doyle Occupational Health & Training
Jason Speaks
2000 Glen Echo Road, Suite 120
Nashville, TN 37215

DATE: 12/29/2000
INVOICE NO: 136
DUE DATE: 1/28/2001

SERVICES PROVIDED	AMOUNT
Database Creation & Management Fee	5,000.00
Development of Courses for the National Guard	95,000.00

TOTAL \$100,000.00



APPENDIX I



[INSERT WITNESS LIST]



EXHIBIT D



LIST OF PROSKAUER CLIENTS CONDUCTING UNAUTHORIZED USE

Visual Data Corp.
Warner Bros.
AOL Time Warner
Deutsche Telekom
Boca Research (acquired by Zoom Telephonics, Inc.)
Intel Corp. (acquired Real 3D)
SGI, Inc. (prior to Intel's acquisition of Real 3D)
Lockheed Martin Corp (prior to Intel's acquisition of Real 3D)
Eclipsys Corp.
SONY
Viacom
Blockbuster
Citrix Systems
Columbia/Tri-Star
Disney
Ronald G. Assaf and Sensormatic Electronics Corp.
Teranex
MPEG LA, LLC (MPEG 2 and MPEG 4)
DVD 6C Licensing Agency (DVD)
Hollywood.com
Florida Atlantic University



HAND NOTES OF MR. WHEELER POINTING TO NDA BREACHES

11 Jan 00
C in pay pass

Based on Bin's work ->

Define element -> depend on data level
based on tools we are using today -
everything is in public domain -
parameters of such a nature - little
if anything we can claim as patents -
tools are very much in public domain -

his claim -> the tools as creative ideas -
breached confidentiality agreement -
problem occurred with Hassan Rich -
integrated into their product -
steps became integrated into Dayle card -
he believes that Hassan Rich -
collectively learned and -> to go
boards and recognize -

Basis for any action -> breach of contract -
when phase + how process worked -
paper trail -

PROSK0112

Capture + mode - 2 steps
today -

originally - no process that took you
from capture to mode -

copy of non-documented that Herson
Must signed -

Client should consider - any patents for the
video → doesn't wear out of and
around it -

Collaborate level of development



EXHIBIT E



MR. BERNSTEIN TRANSMITS INVENTIONS TO RESPONDENT⁴⁶

-----Original Message-----

From: Eliot Bernstein [mailto:alps@netline.net]
Sent: Tuesday, February 23, 1999 7:53 AM
To: Kenneth Rubenstein (E-mail); Christopher C. Wheeler (E-mail)
Subject: Please call when you receive this message. 800.519.0234 or
561.417.8980

Ken,

Per our discussion, I have attached the following file = [process.doc](#).

Eliot

<< File: ATT00027.html >> << File: PROCESS.doc >>

⁴⁶ The first in a series of electronic mail messages that the Company cannot attest to the validity of, but requests First Judicial Department Disciplinary Committee to obtain the matching messages from Respondent's files as much "hacking" has gone on with respect to the Company's information systems.



**RESPONDENTS VISITS PROPRIETARY AND CONFIDENTIAL PAGE OF
COMPANY S WEBSITE ⁴⁷**

-----Original Message-----

From: Eliot Bernstein [mailto:alps@netline.net] On Behalf Of
webmaster@cyberfyds.com
Sent: Thursday, January 28, 1999 4:08 PM
To: 'krubenstein@proskauer.com'
Subject: FW: Crime Watch

iviewit Confidentiality Agreement

The undersigned reader acknowledges that the information provided by Iviewit and Simon & Eliot Bernstein in this business plan and at the specified iviewit website is confidential; therefore, reader agrees not to disclose it without the express written permission of Simon L. Bernstein. This memorandum does not constitute an offer to sell, or a solicitation of an offer to purchase, securities. This business plan has been submitted on a confidential basis solely for the benefit of selected, highly qualified investors and is not for use by any other persons. Neither may it be reproduced, stored, or copied in any form. By accepting delivery of this plan, the recipient acknowledges and agrees that: i) in the event the recipient does not wish to pursue this matter, the recipient will return this copy to iviewit, at the address listed below immediately; ii) the recipient will not copy, fax, reproduce, or distribute this Confidential Business Plan or iviewit web address, in whole or in part, without written permission; iii) all of the information contained herein will be treated as confidential material. Agreement executed by the recipient prior to, or contemporaneously with, its receipt of this Confidential Business Plan

Name: Ken rubenstein E-mail: krubenstein@proskauer.com

⁴⁷ *Supra* Note 45.



RESPONDENT ADVISES MR. BERNSTEIN ON PATENT OVERSIGHT

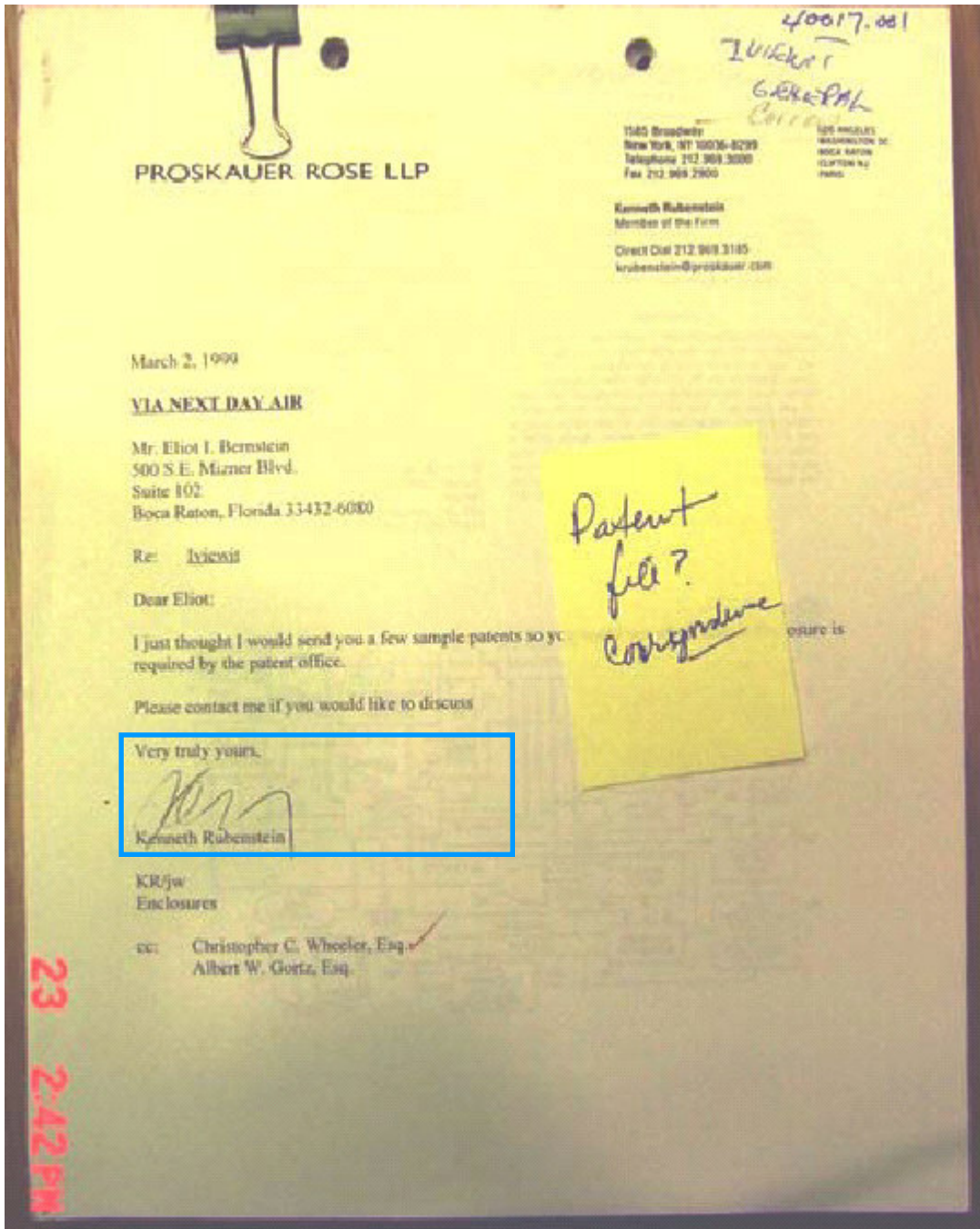



MR. WHEELER TRANSMITS PATENT BINDERS TO RESPONDENT

PROSKAUER ROSE LLP

NEW YORK
LOS ANGELES
WASHINGTON DC
BOCA RATON
CLIFTON NJ
PARIS

Intraoffice Memo

Re: iviewit.com, Inc.
To: Kenneth Rubenstein
From: Christopher C. Wheeler
Date: August 25, 2000
Client-Matter: 40017.001

Enclosed is a copy of iviewit's Patent Portfolio binder.

PROSK000536

0894/40017-001 BRLIB1/274961 v1

08/25/00 05:37 PM (11402)



LETTER OF MR. WHEELER POINTING TO RESPONDENT S REVIEW OF COMPANY S INVENTIONS

APR 26 1999 18:04 FR PROSKAUER ROSE

561 241 7145 TO 2410071#

P.01/02

2255 Glades Road
Suite 340 West
Boca Raton, FL 33431-7360
Telephone 561.241.7400
Elsewhere in Florida
800.432.7746
Fax 561.241.7145

NEW YORK
LOS ANGELES
WASHINGTON DC
CLIFTON NJ
PARIS

PROSKAUER ROSE LLP

Date April 26, 1999

Client-Matter 0894/40017/001

Fax Transmittal

Total Pages (including Cover) 2

From Christopher C. Wheeler

Sender's Room Number

Sender's Voice Number 561.995.4702

Main Fax Operator 561.241.7400

To Eliot I. Bernstein

Fax No. 417.4470

Company iviewit

Voice No. 417.8980

To Jerry Lewin

Fax No. 241.0071

Company Goldstein Lewin

Voice No. 994.5050

Message

Confidentiality Note: This message is confidential and intended only for the use of the addressee(s) named above. It may contain legally privileged material. Dissemination, distribution or copying of this message, other than by such addressee(s), is strictly prohibited. If you have received this message in error, please immediately notify us by telephone and return the original to us at the address above. We will reimburse you for the cost of the telephone call and postage. Thank you.

0894/40017-001 BRJ1/219712 v1

02/18/99 02:28 PM (2743)



PROSKAUER ROSE LLP

2255 Glades Road
Suite 340 West
Boca Raton, FL 33431-7360
Telephone 561.241.7400
Elsewhere in Florida
800.432.7746
Fax 561.241.7145

NEW YORK
LOS ANGELES
WASHINGTON
NEWARK
PARIS

Christopher C. Wheeler
Member of the Firm

Direct Dial 561.995.4702
cwheeler@proskauer.com

April 26, 1999

Mr. Richard Rosman
Lewinter and Rosman
16255 Ventura Blvd., Suite 600
Encino, CA 91436

Re: iviewit, Inc.

Dear Richard:

Under separate cover I have forwarded you a revised Confidentiality Agreement.

As you know we have undertaken representation of iviewit, Inc. ("iviewit") and are helping them coordinate their corporate and intellectual property matters. In that regard, we have reviewed their technology and procured patent counsel for them. We believe the iviewit technology is far superior to anything presently available with which we are familiar. iviewit has filed a provisional patent application on a method for providing enhanced digital images on telecommunications networks. We are advised by patent counsel that the process appears novel and may be protected by the patent laws. While in all matters of this sort, it is far too early to make any final pronouncements, we do believe that there is an extremely good prospect that iviewit will protect their process which is novel and superior to any other format which we have seen.

Very truly yours,

Christopher C. Wheeler

CCW/gb



EXHIBIT F



RESPONDENT S BIOGRAPHY ON PROSKAUER S WEBSITE

Biography:

Ken received his Ph.D. in physics from the Massachusetts Institute of Technology where he also graduated with a B.S. Degree.

Ken received his law degree, cum laude, from New York Law School. He is a registered patent attorney before the U.S. Patent & Trademark Office. Ken is a former member of the legal staff at Bell Laboratories. While there are numerous patent law groups at various firms, Ken and his group distinguish themselves from competitors by being able to deal with very sophisticated technology.

Ken and his group are currently undertaking a number of significant patent and high tech litigations. The group is representing Alcatel, one of the world's leading telecommunications equipment companies, in a major trade secret case against a competitor. The group is also representing Standard Microsystems in a litigation related to Fast Ethernet LANs, Hauppauge Computer in a litigation involving video cards for personal computers, and System Management Arts in a litigation involving object oriented software. The group has also been involved in patent litigation relating to semiconductor memories and service platforms for providing enhanced telecommunications services.

Ken has worked on the formation of a patent pool for MPEG-2 technology, first on behalf of CableLabs, the research and development consortium of the cable TV industry, and now on behalf of MPEG LA LLC, an entity set up to license MPEG-2 essential patents. In particular, Ken worked on selecting those patents which are "essential" to the MPEG-2 standard and therefore suitable for inclusion in the pool. He worked with major consumer electronics companies and set top makers in doing this job. Under this arrangement, the MPEG-2 "essential" patents of a number of major companies are being made available in a single license. The pool has been operational since July 1997 and now has over one hundred and fifty licensees and royalty revenues in nine figures.

This pioneering approach to licensing has been utilized in other contexts. Ken and his associates are now working on another patent pool involving large consumer electronics and entertainment companies concerning DVD technology.

Ken's group is also working on evaluating patents for a pool for the IEEE 1394 standard which is related to interconnecting PCs and various peripherals and a pool for the HAVi standard which is related to interconnection of home audio/video devices.

Ken counsels his clients with respect to the validity and infringement of competitors' patents. Such clients include Standard Microsystems, an IC and local area network component company; C-Cube Microsystems, a developer of video encoder and decoder chips; Divicom, a developer of video encoders and decoders; Starlight Networks, a developer of video server software; and Maker Communications, Inc., a developer of telecommunications integrated circuits. In the area of cryptography, Ken represents Telcordia and CableLabs. He has in the past also represented Tele-TV, a joint venture of NYNEX, Bell Atlantic and Pacific Telesis.

Ken is also heavily involved in licensing, technology transfer and joint development. Ken has successfully concluded a number of license and technology transfer agreements for his clients with companies such as Lucent and Intel.

Ken and his wife, Randee, a social worker, have four children, Ari, Sara, Debbie and Rebecca. Ken enjoys baseball and reading, especially history books.



LETTER OF MR. WHEELER APPEALING TO PARTNERS

Dear Colleagues,

As a firm, we are in a unique position to impact the effectiveness of the Internet and to profit from the same. The firm of iviewit.com, Inc. is one of my clients and Proskauer, Rose, LLP. is a 2.5% shareholder. I have worked closely with [iviewit](http://iviewit.com), for the past 18 months, establishing and fine-tuning their corporate structure. My objective with this letter is to introduce you to this forward-thinking company and to ask for your support and assistance.

The Internet is quickly evolving from a text-based medium that users have been forced to read, into a multimedia platform that users can begin to *experience*. The importance that this evolution has to e-commerce has been likened to the impact felt by television when it was embraced as a marketing and communications tool. [iviewit](http://iviewit.com)'s intellectual property positions them as a leader in the streaming video, streaming audio and virtual imaging online markets. Their technologies have broad ranging applications for many different industries including: entertainment, auctions, education, healthcare and retail.

Because of the extensive applicability of [iviewit](http://iviewit.com)'s products, the vast majority of Proskauer's client relationships represent potential clients for [iviewit](http://iviewit.com). Please join me as I endeavor to introduce my clients to [iviewit](http://iviewit.com) and, in the process, help those clients to gain a competitive advantage through the utilization of [iviewit](http://iviewit.com)'s technologies. Please contact me with any opportunities that you identify and I will arrange an introduction to a member of [iviewit](http://iviewit.com)'s management team. I have enclosed a descriptive flyer from [iviewit](http://iviewit.com) and a multimedia CD-ROM that will serve as an introduction to [iviewit](http://iviewit.com). Additional information can be found at their website, www.iviewit.com.

Thank you for your time and attention. I look forward to working together to help this valued client and to further enhance the value of our equity position in [iviewit](http://iviewit.com).

Sincerely,

Christopher C. Wheeler



PROSKAUER S CLIENT LIST WHEREIN MR. WHEELER PLACES A CHECK MARK NEXT TO RESPONDENT S CLIENTS

PROSKAUER ROSE LLP

NEW YORK
LOS ANGELES
WASHINGTON
BOCA RATON
NEWARK
PARIS

Representative Proskauer Clients

Listed below are a number of clients for whom Proskauer Rose LLP is currently performing legal services.

- | | | |
|---|---|--|
| ✓ Accor (hotels) | Arthur Andersen & Co. | Bostik, Inc. |
| Aerospatiale | ✓AT&T | Bristol-Myers Squibb Company |
| Air India | ✓Autodesk, Inc. <i>AUTODESK</i> | The Broadway Initiative Corporation |
| Alarm Device Manufacturing Co. | Avis Rent-A-Car System | Brookdale Hospital Medical Center |
| ✓ Alcatel (Telecom - DSL) | The George Balanchine Trust | The Brooklyn Hospital Center |
| Allegheny Health, Education and Research Foundation | ✓Bally Shoes | ✓Brooks Brothers |
| ✓ Alliance of Motion Picture and Television Producers | Banca del Sempione | Building Services Funds |
| ✓ The Alpine Group, Inc. <i>Alpine Vision subsidiary</i> | Bancol S.A. | Bull Run Corporation |
| Alton Ochsner Medical Foundation | Bank United of Texas FSB | Business Software Alliance |
| Amerada Hess Corporation | Banque Privée Edmond de Rothschild | ✓Buster Brown Apparel, Inc. |
| American Federation of Musicians and Employers' Pension Fund | Baring Communications Equity Limited | Cafe des Artistes |
| ✓ American League of Professional Baseball Clubs | ✓Barneys New York | Canal Capital Corporation |
| ✓ ATP Tour, Inc. (Tennis) | ✓Bear, Stearns & Co. Inc. | ✓ABC, Inc. |
| AFTRÄ Health & Retirement Funds | Becton Dickinson | ✓Careers USA |
| The Albert Fisher Group PLC | BDO Seidman | Castle Oil Corporation |
| American Jewish Committee | ✓Bed Bath & Beyond Inc. | ✓CBS, Inc. |
| American Maritime Congress | Bell Atlantic Asset Management Co. | Celadon Group, Inc. |
| ✓ The American Society for the Prevention of Cruelty to Animals | ✓Bell Atlantic Corporation | Celgene Corporation |
| Anden Group | ✓Benetton Group, Spa. | ✓Center for Missing & Exploited Children |
| ✓Andersen Consulting | Berkshire Capital Corporation | Ceridian Benefits Services, Inc. |
| Antigenics | Estate of Leonard Bernstein | Chambers Development Co., Inc. |
| Apollo Real Estate Advisors, LP | Beth Israel Medical Center | Champion International Corporation |
| ✓Arena Football LLC | ✓ Beverly Enterprises <i>acquired from BE</i> | C&D Technologies, Inc. |
| ✓Arista Records | ✓Big Flower Holdings, Inc. | Charterhouse Group |
| | Biövail Corporation International | Charter Technologies, Inc. |
| | ✓ Blair Industries, Inc. | The Chase Manhattan Bank |
| | ✓BMG Entertainment | ✓Chrysler Corp. |
| | Bollere Technologies | |

PROSK0454



PROSKAUER ROSE LLP

- Ciba Specialty Chemicals Corporation
- CIBC World Markets Corp.
- ✓ Citibank, N.A.
- ✓ City Center of Music & Drama
- ✓ City of New York
- Clal (Israel) Ltd.
- Club Méditerranée, S.A.
- ✓ Columbia Pictures Industries, Inc.
- Colgate-Palmolive Co.
- Columbia University
- ✓ Communications Equity Associates Inc.
- Community Health Care Physicians P.C.
- La Compagnie Financiere Edmond de Rothschild Banque
- NS* ✓ Computer Horizons Corp.
- Comtech Telecommunications
- Consolidated Edison Company of New York, Inc.
- Consumers Union of United States
- Cooper Union
- The Joseph and Robert Cornell Memorial Foundation
- ✓ Countdown Entertainment
- Craig Enterprises
- Credit Lyonnais
- Credit Suisse First Boston
- ✓ Cross Country Staffing
- CSS Industries, Inc.
- CV Reit
- Daily News, L.P.
- The Darnon Company, Inc.
- Dean Foods of California
- ✓ DELIA*s
- Deloitte & Touche
- Demolition Worker's Funds
- The Depository Trust Company
- The Edmond de Rothschild Foundation de Sede A.G.
- Development Corporation for Israel
- ✓ The Donna Karan Company
- Douglas Elliman
- Dow Jones & Company
- ✓ The Dress Barn, Inc.
- The Dun & Bradstreet Corporation
- Eagle National Bank of Miami, N.A.
- EOS Corporation
- Richard A. Eisner & Company, LLP
- El Diario/La Prensa
- ✓ EMI Music Publishing
- Equitable Life Assurance Society of the United States
- Environmental Systems Products
- Ernst & Young LLP
- European American Bank
- EURO RSCG Holdings, Inc.
- ✓ Ferrari North America
- ✓ Fiat U.S.A., Inc.
- ✓ Finlay Fine Jewelry
- First Union National Bank
- Flushing Savings Bank
- Foot Cone & Belding
- The Ford Foundation
- ✓ Forte Hotels
- Fuji Bank, Ltd.
- General Building Laborer's Funds
- Generic Pharmaceutical Industry Association
- Genlyte Thomas LLC
- GFI Securities Group
- ✓ Giant Group, Ltd.
- ✓ Golden Books Entertainment Company, Inc.
- Golden Books Family Entertainment, Inc.
- Gotham Construction Corporation
- GNB Bank
- ✓ Grace Plaza of Great Neck, Inc. *(inversing h)*
- Greater New York Hospital Association
- G.T.E. (General Telephone & Electric)
- ✓ Happy Kids, Inc.
- Estate of Keith Haring
- Harvard Custom Manufacturing, Inc.
- ✓ Havas Advertising
- ✓ The Hearst Corporation
- Henry Schein, Inc.
- Hermes of Paris, Inc.
- Lauryn Hill
- H. J. Baker & Bro., Inc.
- ✓ Home Box Office
- ✓ Home Depot U.S.A., Inc.
- ✓ Home Shopping Network, Inc.
- Hospital for Special Surgery
- HR Textron
- Humana Inc.
- Hutchinson S.A.
- Iberia Airlines
- IBJ Schroder Bank & Trust Company
- ICN Pharmaceuticals, Inc.
- IDB Holding Corporation Ltd.
- Insignia Financial Group, Inc.
- ✓ Interscope Records
- Interstate Brands Corporation
- Invesco
- ✓ Island Records
- Israel Discount Bank of New York
- ITQCHU International, Inc.
- ✓ iTurf



PROSKAUER ROSE LLP

- Japan Air Lines
- Jenny Craig, Inc.
- Jerusalem Capital Studios
- The Joseph and Robert Cornell Memorial Foundation
- J.P. Morgan & Co., Incorporated
- ✓ Kaleidoscope Films
- ✓ Kapson Senior Quarters Corp. *Spring homes*
- Key Biscayne & Trust Company
- Keystone Shipping Co.
- ✓ King World Productions, Inc.
- Kinray, Inc.
- Kontron Instruments
- Korea Asset Management Corp.
- Korea District Heating Corporation
- Korea Electric Power Corporation
- Kraft Foods, Inc.
- KR Capital Advisors
- The Laird Group Plc.
- Lakeside Industries
- Lally McFarland & Pantello
- Lazard Freres & Co.
- ✓ The League of American Theatres and Producers, Inc.
- League of Voluntary Hospitals and Homes of New York
- Le Meridien Hotel & Resorts
- Lenox Hill Hospital
- Levitt Homes Incorporated
- Liberty Fabrics/Courtauld Textiles
- ✓ Lifetime Entertainment Services
- ✓ Lincoln Center for the Performing Arts, Inc.
- Lincolnshire Management, Inc.
- LG Group
- L.J. Hooker Corporation, Inc.
- Lone Star Industries, Inc.
- ✓ Madison Square Garden Corp.
- ✓ Madonna
- Maimonides Medical Center
- ✓ Major League Soccer
- Marchon & Marcolin Eyewear, Inc.
- Marcus Brothers Textiles, Inc.
- Maritime Service Committee
- Marubeni America Corporation
- Mason Tenders' District Council Trust Funds
- Matson Navigation Company, Inc.
- MBIA Insurance Corporation
- McDonald's Corporation
- McKinsey & Company, Inc.
- Medical Group Council
- MediaCopy Inc.
- Memorial Sloan Kettering Cancer Center
- ✓ Mennen Medical Ltd.
- The Merchandising Group, LLC
- Meridien Hotels
- Merrill Lynch & Co., Inc.
- Methodist Hospital of Southern California
- ✓ Metro-Goldwyn-Mayer
- Metro-North Commuter Railroad
- Metropolitan Life Insurance Co.
- Metropolitan Opera Association
- Micromedia Affiliates, Inc.
- Microwave Power Devices, Inc.
- Milberg Factors, Inc.
- ✓ Milford Plaza Hotel
- ✓ Miller Brewing Company
- Edward J. Minskoff Equities, Inc.
- ✓ Miss Universe, Inc.
- ML Media Partners
- Montefiore Medical Center
- Moran Towing & Transportation Co., Inc.
- Mormac Marine Transport
- Motel 6
- Mount Sinai-NYU Medical Center
- Moxon Corporation
- Museum of Discovery & Science
- ✓ Museum of Modern Art
- ✓ National Artists Management Company, Inc.
- National Bank of Pakistan
- ✓ National Basketball Association
- ✓ National Broadcasting Company
- The National Governors' Ass'n
- ✓ National Hockey League
- NKO, Inc.
- The National Law Journal
- ✓ National League of Professional Baseball Clubs
- National Notary Association
- National Syndications Inc.
- NationsBank of Florida N.A.
- ✓ NBA Properties, Inc.
- The Nederlander Organization
- ✓ Network Event Theater, Inc.
- ✓ New Jersey Performing Arts Center
- Newkirk Management Corp.
- ✓ New Line Cinema
- New York Blood Center
- ✓ New York City Ballet
- ✓ New York City Opera
- New York City Transit Authority
- New York Eye & Ear Infirmary
- ✓ New York Convention Center Operating Corporation (Javits Center)
- New York Law Journal
- New York Philharmonic
- New York Presbyterian Hospital
- New York Public Library



PROSKAUER ROSE LLP

- New York State Bankers Ass'n
- New York Stock Exchange
- The New York Times
- ✓ NHL Enterprises
- Nidera S.A.
- ✓ Nine Inch Nails
- NMU Pension & Benefits Plan
- North Shore Long Island Jewish Medical Center
- NorthStar Presidio Management Company, LLC
- ✓ Nothing Records
- Oppenheimer & Company
- Oppenheimer Capital
- Optomic Medical Technologies Ltd.
- Overseas Shipholding Group, Inc.
- Pathmark Stores, Inc.
- PEC Israel Economic Corporation
- PP&L Inc.
- Philips Electronics North American
- ✓ Pergament Home Centers, Inc.
- ✓ Philadelphia Eagles
- Pirelli Tire LLC
- Pirelli Cables and Systems LLC
- Pitney Bowes
- ✓ Pivotal Group, Inc.
- Polytechnic University
- Pratt Institute
- Presidio Capital Corp.
- Price Communications Corporation
- ✓ Prince Sports Group, Inc. / Nordica/Rollerblade
- Provident Investment Counsel, Inc.
- Prudential Insurance Company of America
- Prudential Securities Incorporated
- Radio City Productions, Inc.
- ✓ The Rainbow Room
- Ranbaxy Laboratories Limited
- Ranieri & Co., Inc.
- The Reader's Digest Association, Inc.
- Realty Advisory Board
- ✓ Recording Industry of America
- ✓ Red Apple Group
- Reeves Industries, Inc. Capital Related Capital Company
- Republic National Bank of N.Y.
- Restaurant Associates Corp.
- Reynolds Metals Company
- Rhodia Inc.
- Riddell, Inc.
- The Rockefeller Group, Inc.
- The Rockefeller University
- Rose Associates
- Rose's Stores Inc.
- Roxbury Capital Management
- Roytex, Inc.
- RPS, Inc.
- R.S. Lauder, Gaspar & Co., LP
- Rudin Management
- Sanofi
- S.C. Johnson & Son, Inc.
- Schein Pharmaceutical, Inc.
- Schlumberger Industries, Inc.
- Scholastic Inc.
- Scitex Corporation Ltd.
- Seoul Bank
- 754 Fifth Avenue Associates LP.
- Sheffield Steel Corporation
- Shinhan Bank
- Simon & Schuster, Inc.
- Solomon R. Guggenheim Museum
- ✓ Sotheby's, Inc.
- Spencer Trask Securities Inc.
- SPP Hambro Securities
- St. Luke's-Roosevelt Medical Center
- Stamford Hotels Corporation
- Starrett Housing Corporation
- State University of New York
- Strausman Construction Co., L.P.
- Subaru Distributors Corp.
- Sunglass Hut International, Inc.
- Sun Life Insurance Co. of America
- Super-Sol Ltd.
- Superior TeleCom Inc.
- Swissôtel
- Tanker Service Committee
- Teachers Insurance & Annuity Association of America
- The Official Information Company
- Theatre Porters and Cleaners Funds
- Theatre Stagehands Funds
- Theatre Ticketsellers Funds
- Theatre Ushers Funds
- Thomson-Leeds Company, Inc.
- ✓ Time Warner Inc.
- Times Square Business Improvement District Committee
- ✓ Tony Award Productions
- Toshiba America Electronic Components, Inc.
- Total Fina
- Towers Perrin
- Trader Horn
- Trans World Airlines, Inc.
- Triborough Bridge & Tunnel Authority
- Trism, Inc.
- True North
- ✓ The Trump Organization



PROSKAUER ROSE LLP

- Trustee of Allegheny Health, Education and Research Foundation
- Tullett & Tokyo, Inc.
- Shania Twain
- 24/7 Media Inc.
- UUPCW Local 1262 Pension, Welfare and Legal Funds
- UIS, Inc.
- Ulano Corporation
- Underwriters Laboratories, Inc.
- Unilever United States Inc.
- Union Theological Seminary
- United Bank of Switzerland
- United Industrial Syndicate
- United Parcel Service, Inc.
- United States Surgical Corp.
- Universal Music
- US JVC Corp.
- U.S. News & World Report
- U.S. Realty Advisors
- U.S. Trust Co. of New York
- U.S. Trust Company of Florida
- USA Networks, Inc.
- Value Line, Inc.
- Values.com LLP
- Veronis, Suhler & Associates
- Vetco Inc.
- Visiting Nurse Service
- VS&A Communications Partners
- Warburg Dillon Read
- Warner Bros.
- Webco Industries, Inc.
- Weber Aircraft
- Western Pacific Housing
- Westholm Partners
- Wexford Management LLC
- Wilshire Real Estate Investment Inc.
- Winterland Productions
- WNBA
- C.K. Witco Corporation
- W.R. Huff Asset Management Co.
- Yamaichi International (America)
- Yellow Book USA, LP.
- The Zomba Group
- Zomba Group of Companies
- Zurich Capital Markets

PROSK0458



OCTOBER 1999 NEW BUSINESS COMMITTEE CHECKLIST⁴⁸

NEW BUSINESS COMMITTEE Page 1 of 8

Request: 9612

NEW BUSINESS COMMITTEE
Checklist

TO: The Attorney completing this form (i.e.: The Originating Attorney or the Attorney responsible for the Relationship with this Prospective Client):

Wheeler, Christopher C.
enter your name on this line

FROM: The Business Committee

Please complete this checklist, including as much detail as possible. When you have done so, please give it to your secretary for processing. Read carefully the form (s)he returns to you, as the processing of the information you provide on this checklist will generate affirmative statements on the resulting form, for which you will be responsible. When you are satisfied that the resulting form (not this checklist) is accurate and complete, submit the form electronically. After submitting the form, you will receive an email with the new New Business Checklist as an attachment. Review the attachment for accuracy, then forward it to the New Business Committee (email address: NBC) or your Department Chair. The first line of the attachment will alert you when Department Chair approval is required.

**** Request screen ****

Client Number (if existing Client): 40017-~~DK~~ 020

Client Name (if prospective Client): IVIEWIT LLC

Client Type:

Estate.....	_____
Foundation.....	_____
Governmental.....	_____
Individual(s).....	_____
Not-For-Profit.....	_____
Privately Held.....	<u>X</u>
Publicly Held.....	_____
Trust.....	_____

Nature of Client's Business: software

http://proskaueratwork/newBuss/GenHtml/TempMain53369280.htm 10/5/99

2A 11:58AM

Chris
For your
Review.
Submitted
NBC
10-5-99
10-5-99
To Mercedes
10-6-99

⁴⁸ The Company has no knowledge that this document was ever formally submitted within Proskauer; the Company requests First Judicial Department Disciplinary Committee to obtain a true copy of this document/



**** Matter screen ****

Nature and scope of the matter: Patent/General

Has a formal "Conflict-Of-Interest" search been conducted by the Records Department? Yes (X) No ()

If "Yes," skip to the next question.

If "No," please explain:

If this matter is a litigation, will our client be the plaintiff? Yes () No (X)

Does this litigation involve a claim by an employee or former employee against an employer or former employer? Yes () No (X)

If this matter is a transaction, will it involve a closing? Yes () No (X)

Department primarily handling this matter:

- Corporate (X)
Health Care
Labor
Litigation
Personal Planning
Real Estate
Tax

Practice Area primarily handling this matter:

- Antitrust
Banking
Bankruptcy
Corporate (X)
Employee Benefits
Entertainment
Environmental
Health Care
Immigration
Intellectual Property
Labor
Litigation

24 11 58 AM



Personal Planning _____
 Real Estate _____
 Sports _____
 Tax _____

Office primarily handling this matter:

Boca Raton _____
 Los Angeles _____
 New York _____
 New Jersey _____
 Paris _____
 Washington _____

**** Attorneys screen ****

Originating Attorney(s) :Gortz, Albert W.
 Relationship Attorney(s) :Gortz, Albert W., Wheeler, Christopher C.
 Primary Relationship Attorney :
 Alternate Attorney(s) :
 Responsible Attorney :Gortz, Albert W.
 Assisting Attorney(s) :Wheeler, Christopher C.

**** Conflicts screen ****

Client Affiliates :iViewit LLC
 Potential "Adverse" Parties :N/A
 Opposing Counsel :

Will the Client be asked to execute a conflict waiver? Yes () No ()

The various types of conflict waivers are set forth in the form engagement letter (Document #687711, NYLIB1).

If "No," skip to the next screen.

If "Yes," what kind of conflict waiver?

General advance conflict waiver _____
 Specific conflict waiver _____

2/11/09 11:58 AM



**** Billing 1 screen ****

Billing Address Level:

Client Level (All matters for this client will be billed to this address) ... _____
Matter Level (Use this billing address for this new matter only) _____

Billing Address:

Address: 2255 Glades Road, Suite 337W Boca Raton,
FL 33431

City: BOCA RATON

State: FL

Zip: 33432-6080

Phone Number: BUSINESS*800-519-0234

Fax Number:

E-Mail:

Billing Contact Name & Title: Brian G. Uhley

**** Billing 2 screen ****

What is the expected fee range if this matter is handled to its anticipated conclusion?

- Pro Bono / Accommodation _____
- Up to \$5,000 _____
- \$ 5,000 - \$ 25,000
- \$ 25,000 - \$ 50,000 _____
- \$ 50,000 - \$ 100,000 _____
- \$ 100,000 - \$ 250,000 _____
- \$ 250,000 - \$ 500,000 _____
- \$ 500,000 - \$1,000,000 _____
- Over \$1,000,000 _____

Will the Client be billed on a MONTHLY basis for fees and disbursements, with payment to be made by the Client 30 to 60 days after submission of bills? Yes () No ()

If "Yes," skip to the next screen.

If "No," please indicate the billing frequency type below with an explanation as to why billing is not monthly (approval of your Department Chair and the New Business Committee will be required):

10/5/99 11:58 AM



- Bi-Monthly
- Quarterly
- Conclusion
- Other

Please explain:

**** Billing 3 screen ****

Will the Client be billed at our "Standard" Rates? Yes () No ()

If "Yes," skip to the next question.

If "No," please indicate the billing rate type below with an explanation as to why billing is not "Standard" (approval of your Department Chair and the New Business Committee will be required):

- Accommodation In-House
- Accommodation Outside
- Blended
- Capped
- Contingent
- Discount - 10%
- Discount - 15%
- Discount - 20%
- Discount - Disbursements only
- Discount - Misc
- Discount - Other
- Discount - Volume
- Discount - W/Potential Premium
- Fiduciary Commissions
- Fixed
- Premium
- Pro Bono
- Reduced

Please explain:

Have you submitted an estimate or budget to the Client which may be viewed as a "fee cap" or "limitation" on the amount the Client will be required to pay? Approval of your Department Chair and the New Business Committee will be required. Yes () No ()

If "Yes," please explain:

MVG: 11:55 AM



**** Billing 4 screen ****

Will there be an initial retainer?

Yes () No (X)

The various types of retainer arrangements are set forth in the form engagement letter (Document #687711, NVLIBI).

If "Yes," how much: \$0.00 which constitutes

- An advance payment for services rendered _____
- An advance payment for the life of the relationship (Evergreen retainer) _____
- A fixed fee for specified service _____
- An availability retainer _____

If "No," why not? Existing, ongoing client

Firm policy requires that all new clients execute an engagement letter prior to our beginning work. Will there be an engagement letter? Yes () No (X)

If "Yes," please submit a copy (with client's signature) to the New York Office Records Department as soon as possible, and skip to the next screen.

If "No," please explain: Existing, ongoing client

**** Billing 5 screen ****

Do you have knowledge of the Prospective Client's financial condition? Yes (X) No ()

Are you satisfied that the Prospective Client has the financial ability to pay for fees and disbursements on a 30-or 60-day basis? Yes (X) No ()

Are you aware of any problems the Prospective Client has had in paying for legal services in the past? Yes () No (X)

If "No," skip to the next question.

If "Yes," please explain:

Have this Client and all related Clients regularly paid their bills within 60 days of submission? Yes (X) No ()

If "Yes," skip to the next question.



If "No," please explain:

Have we had to write bills down after their submission to this Client or to any related Clients?

Yes () No (X)

If "No," skip to the next question.

If "Yes," please explain:

Are there outstanding unbilled time charges or disbursements more than 60 days old for this Client or for any related Clients?

Yes () No (X)

If "No," skip to the next question.

If "Yes," please explain:

**** Billing 6 screen ****

Is a third party or group of Prospective Clients going to be responsible for the payment of all or part of the fees and disbursements?

Yes () No (X)

If "No," skip to the Referral screen.

If "Yes," answer all three remaining questions in this screen.

Who is the third party or group of Prospective Clients?

Please explain the billing and payment arrangement:

Are you satisfied that the third party or group of Prospective Clients has the financial ability to pay the bills?

Yes () No ()

**** Referral screen ****

Has this new matter been referred to us by a third party?

Yes () No (X)

If "No" skip the remaining questions.

If "Yes," answer the remaining questions.

Please check the appropriate firm type for the third-party firm:

24 11:59 AM



NEW BUSINESS COMMITTEE Page 8 of 8

Accounting Firm..... _____
Actuarial and Other Consulting Firm..... _____
Bank, Trust Co., Custodians, Etc..... _____
Commercial or Residential R. E. Broker..... _____
Financial Planners or Stock Broker..... _____
Insurance Companies and Brokers..... _____
Law Firm..... _____
Public Relations..... _____
Other..... _____

Referring Firm information:

Firm Name: _____
Address: _____
City: _____
State: _____
Zip: _____
Phone Number: _____
Fax Number: _____
E-Mail: _____
Referral Name & Title: _____

24 11:59 AM

<http://proskaueratwork/newBusi/CienHtml/TempMain53369280.htm> 10/5/99



EXHIBIT G



EMAIL OF MR. UTLEY NAMING RESPONDENT AS ADVISOR

-----Original Message-----

From: Brian G. Utley [mailto:brian@iviewit.com]

Sent: [Wednesday, April 18, 2001 11:17 AM](#)

To: Eliot I. Bernstein; 'simon@adelphia.net'; 'kanderson@myCFO.com'; 'dg_kane@msn.com'; 'glewin@goldsteinlewin.com'; 'hankpow@gate.net'; 'bprolow@tiedemannfunds.com'; Maurice Buchsbaum

Cc: 'Christopher C. Wheeler (E-mail)'

Subject: RE: Minutes of the Board Meeting of April 14, 2001

I was advised by Proskauer Rose that anyone who was in an active due diligence stage and who was review our intellectual property as part of that due diligence should receive a copy of the examiners opinion. Theref the opinion was forwarded to the same people who have received copies of the patent filings namely, Warner Brothers and Irell & Manella. [Ken Rubenstein, as our advisor, was also copied.](#) Your father suggested that, because of the importance of our intellectual property, our own Board of Directors should be aware of the cur status of our applications. With respect to Irell & Manella, it is quite likely that we will need to engage them or some other alternative counsel in order to respond to the opinion. I have a copy of Alvear's book if you need

With respect to processing the requested demo tape, you may recall that you actually set the standard by processing similar demo material for igallery some time ago. This job was handled discreetly and the 18 yea employee referred to had already been released from the business. We are not in the business of processin adult entertainment material and have consistently represented this position.

I trust this clarifies both matters.

Brian

-----Original Message-----

From: Eliot I. Bernstein

Sent: Tuesday, April 17, 2001 7:07 PM

To: 'simon@adelphia.net'; 'kanderson@myCFO.com'; 'dg_kane@msn.com'; 'glewin@goldsteinlewin.c
'hankpow@gate.net'; 'bprolow@tiedemannfunds.com'; Maurice Buchsbaum

Cc: Brian G. Utley; Christopher C. Wheeler (E-mail)

Subject: RE: Minutes of the Board Meeting of April 14, 2001

Brian - several board members asked that you specify which of our attorneys advised you and on wh legal references you were cited to disseminate the PCT report. Also, was there some reason that yo have recently decided to share patent news of any nature with those involved, prior you had never disclosed to the Board or potential clients anything that was regarding the patents?

I had already discussed with David the examiners report and we had begun to research the referenc Jose Alveraz's book, it does not look particularly relevant to our process.

Also, I find it in poor taste that you are encoding pornography with a 17 year old girl present in the ro; this could potentially be a risk to the company, so I ask that all further business relating to pornograp handled outside the office and without iviewit personnel or equipment. Could you please have our attorney's advise on the risks you may be subjecting us to in this matter. These matters were broug my attention by several of our employees who were offended.

Best,
Eliot



-----Original Message-----

From: Bonnie M Barwick

Sent: Tuesday, April 17, 2001 5:18 PM

To: 'simon@adelphia.net'; Eliot I. Bernstein; 'kanderson@myCFO.com'; 'dg_kane@msn.com'; 'glewin@goldsteinlewin.com'; 'hankpow@gate.net'; 'bprolow@tiedemannfunds.com'; Maurice Buchsbaum

Cc: Brian G. Utley

Subject: Minutes of the Board Meeting of April 14, 2001



www.iviewit.com

Dear Sirs,

As requested by Brian Utley please find attached a copy of the Minutes of the iviewit Holdings Inc. Board of Directors meeting of April 14, 2001. A hard copy of these minutes as well as a copy of the Patent Cooperation Treaty numbers PCT/US00/15405 and PCT/US00/15406 will follow by mail.

Bonnie M. Barwick

Office Manager/Executive Assistant
2255 Glades Road
One Boca Place-Suite 337W
Boca Raton, Florida 33431
Voice: 561-999-8899 extn. 302
Fax: 561-999-8810
Toll Free: 877-484-8444
email: bonnie@iviewit.com



WACHOVIA SECURITIES PRIVATE PLACEMENT MEMORANDUM NAMING RESPONDENT AS COMPANY COUNSEL



CONFIDENTIAL

Company has retained Foley & Lardner to shepherd its patent development and procurement. In addition, the Company has retained Kenneth Rubenstein of Proskauer Rose, LLP to oversee its entire patent portfolio – Mr. Rubenstein is the head of the MPEG-2 patent pool.

iviewit has assembled a complementary and seasoned, management team with executive rank, Fortune 100 and early-stage, entrepreneurial experience. The Company has retained Korn / Ferry to assist in the identification and recruitment of a high impact Chief Executive Officer (preferably from the media or entertainment industry) and an experienced Chief Technical Officer.

Since its June 1999 inception, the Company has raised over \$4.3 million of venture capital from Crossbow Ventures, Huizenga Holdings, and individual investors.

Technology Overview

iviewit's suite of video and imaging technology processes work across all industry platforms.

Imaging:

iviewit's imaging process is an enabling technology that creates an unparalleled, content-rich, viewing experience. Significant advantages of iviewit's imaging process include the following:

- Photo-quality Internet images
- Resistance to pixelation even at 30+:1 magnification (note: depending upon the material and the desired magnification)
- Full-screen and panoramic viewing up to 360°
- Consistent quality regardless of the end-user's Internet connection
- File sizes of 30Kb to 700 Kb for full panorama

Video:

The Company's video technologies allow high quality video streaming in the 150-300 Kbps range, providing better product and price performance for the product delivered and a significantly improved results in the 28-150 Kbps range. Below is a chart comparing iviewit's video capability to current industry levels:

<u>Bandwidth Range</u>	<u>iviewit Frame Rate</u>	<u>Industry Typical Frame Rate</u>
28-56 Kbps	8-15 frames/sec.	4-8 frames/sec.
56-150 Kbps	15-30 fps	12-20 fps
150-300 Kbps	30 fps	12-24 fps

The iviewit video technology is a highly scalable process costing approximately \$1.50/min of encoded video. The resulting files are ~25% less than comparable quality files. iviewit's 220Kps streams are equivalent to competition 300Kbps streams.

Business Strategy

iviewit intends to serve as an end-to-end applications solutions provider incorporating iviewit's proprietary imaging and or video technologies as well as a full-service image and video encoding, hosting and serving provider. iviewit licenses its imaging solutions to B2B and B2C clients in the auction, collectibles, and retail space with subsequent marketing into the healthcare and medical markets. iviewit is also structuring OEM and re-seller relationships to bundle the imaging software and processes with existing hardware including: digital cameras, scanners, and PCs. iviewit is structuring video license agreements with major content and broadband access providers to incorporate the iviewit process into video encoding solutions for direct internet streaming.

iviewit technologies are "process technologies" with pending patents based on efficiency equations, and many of the applications for these technologies are just now being recognized.



WACHOVIA SECURITIES PRIVATE PLACEMENT MEMORANDUM NAMING RESPONDENT AS ADVISORY BOARD MEMBER

CONFIDENTIAL

Investment Management, both based in London. Among his primary areas of expertise are technology research and economic research, including electronics, telecommunications and computer software. Most recently, he was Senior Technology Analyst and Vice President of Southeast Research Partners, Inc. where he worked with leading technology companies. He earned a bachelor of arts degree at Yale University and a master of business administration degree at Stanford University.

Advisors

Alan J. Epstein

Partner, Armstrong Hirsch Jackoway Tyerman & Wertheimer, P.C.

Mr. Epstein's law practice consists of advising Internet companies on various issues pertaining to the entertainment and sports industries, including the creation, licensing and acquisition of content, the introduction and negotiation of strategic partner relationships, and various other matters relating to the convergence of technology and content. Mr. Epstein also advises his firm's numerous celebrity clients on the exploitation and protection of their name and likeness rights and content on the Internet, as well as merchandising, endorsement and sponsorship deals. Prior to entering the UCLA School of Law, Mr. Epstein was a certified public accountant at Deloitte Haskins & Sells in Dallas, Texas.

Kenneth Rubenstein

Partner, Proskauer Rose LLP

Mr. Rubenstein is a partner at Proskauer Rose LLP law firm and is the patent attorney for iViewit. He is a registered patent attorney before the U.S. Patent & Trademark Office. Mr. Rubenstein counsels his clients with respect to the validity and infringement of competitors' patents, as well as prosecutes patent applications. For the past several years he has worked on the formation of a patent pool, for MPEG-2 technology, involving large consumer electronics and entertainment companies. He is also a former member of the legal staff at Bell Laboratories. Mr. Rubenstein received his law degree, cum laude, from New York Law School, and his Ph.D. in physics from the Massachusetts Institute of Technology where he also graduated with a B.S. Degree.

Christopher C. Wheeler

Partner, Proskauer Rose LLP

Mr. Wheeler is a member of Proskauer Rose LLP's Corporate Department and as a partner in the Florida office has a versatile transactional practice. He has had extensive experience in real estate and corporate law, institutional lending and workouts, administrative law and industrial revenue bond financing. Moreover, he serves as a strategist and counselor to many clients in handling their other legal and business matters. Mr. Wheeler is well-versed in general corporate law as well as mergers and acquisitions and securities matters. He has guided companies from startup through initial private placements to public offerings. A graduate of Hamilton College and Cornell Law School, Mr. Wheeler was a member of the managing Board of Editor of the Cornell Law Review.

Legal & Accounting Counsel

Arthur Andersen, LLP

Arthur Andersen's vision is to be the partner for success in the New Economy. The firm helps clients find new ways to create, manage and measure value in the rapidly changing global economy. With world-class skills in assurance, tax, consulting and corporate finance, Arthur Andersen has more than 70,000 people in 83 countries that are united by a single worldwide operating structure that fosters inventiveness, knowledge sharing and a focus on client success. Since its beginning in 1913, Arthur Andersen has realized 86 years of uninterrupted growth, with 1999 revenues over \$7 billion. Arthur Andersen is a business unit of Andersen Worldwide.

Proskauer Rose, LLP

This law firm is one of the nation's largest law firms, providing a wide variety of legal services to major corporations and other clients through the United States and around the



LETTER OF ALAN J. EPSTEIN, PARTNER OF ARMSTRONG HIRSCH
JACKOWAY TYERMAN & WERTHEIMER, LOS ANGELES, CAL.

May 19, 2000

VIA MESSENGER

Mr. Gregg W. Ritchie
Pacific Capital Group, Inc.
360 N. Crescent Drive
Beverly Hills, CA 90210

Re: iviewit.com

Dear Gregg:

I very much enjoyed meeting you for lunch earlier this week. As promised, enclosed is a copy of the Business Plan for our client, iviewit.com.

Iviewit has developed two proprietary and complimentary technologies to enhance video and images delivered on the internet. The first is a state-of-the-art technology which enables full-screen, full-frame rate (i.e., 30 frames per second) streaming video to be viewed by any internet video player at bandwidths as low as 150 kbps, with increased quality and reduced file size. The second digital imaging technology creates an opportunity for full screen still images and 360° panoramic views that can be magnified with minimal image distortion.

Iviewit has protected its technologies by filing and securing eight patent pending applications, and is currently buffering and expanding those patents through a significant supplemental filing. Iviewit is represented by several of the most prominent patent law firms and attorneys in the world. Bill Dick, who is the head of the intellectual property department of Foley & Lardner in Milwaukee, Wisconsin, was formerly in charge of IBM's foreign patent division. Mr. Dick and his patent team of attorneys are preparing all of iviewit's supplemental patent filings and are drafting all of iviewit's license agreements. Iviewit's potential patent litigation (if any) will be handled by Ken Rubenstein, who is the head of intellectual property litigation group at the law firm of Proskauer Rose in New York City. Mr. Rubenstein is in charge of all patent litigation on behalf of the MPEG patent pool, in addition to a number of other high-profile technology litigation matters.



Mr. Gregg W. Ritchie
May 19, 2000
Page 2

Iviewit has licensed its technology and providing services to a number of substantial clients, such as hollywood.com, broadway.com, Hyatt Hotels and Resorts, and Great Expectations Dating Service. Iviewit also is in final negotiations to license its technology to playboy.com, medicalonline.com (x-rays, MRI's CT-scans, etc.) americanenterprise.com (multi-hour surgical and educational videos), gregmanningauctions.com (one of the largest auction houses) and many other clients in the entertainment, health care, automotive and other industries.

Iviewit initially raised \$500,000 of seed capital from Wayne Huizenga's venture group (at a \$10 million post-money value). Within the last few months, Iviewit raised \$1.5 million in a Series A round at a \$25 million post-money valuation from an investment group led by several individuals who previously ran Merrill Lynch's venture division. Iviewit is currently seeking an additional \$1-\$2 million in the Series A round, with a Series B round (\$10 million minimum) to follow later this year. The proceeds will be used to provide working capital (including the leasing/purchase of equipment and facilities) which will enable iviewit to fulfill its substantial backlog of orders and to expand its licensing operations. Iviewit is currently in discussions with several of the nation's leading investment banks to lead the Series B fundraising efforts.

The iviewit technology is most easily explained through a demonstration. If Pacific Capital or its Venture Group are interested in learning more about the company, please let me know and I will arrange to have the principals fly to Los Angeles for a meeting. Although you can see some of the company's technology and applications on the website (www.iviewit.com), the highest-quality work is not available for public viewing and is best seen through a private demonstration.

I look forward to hearing from you.

Best regards.

Very truly yours,

Alan J. Epstein



EXHIBIT H



COMPANY S VIDEO TECHNOLOGY SPECIFICATION

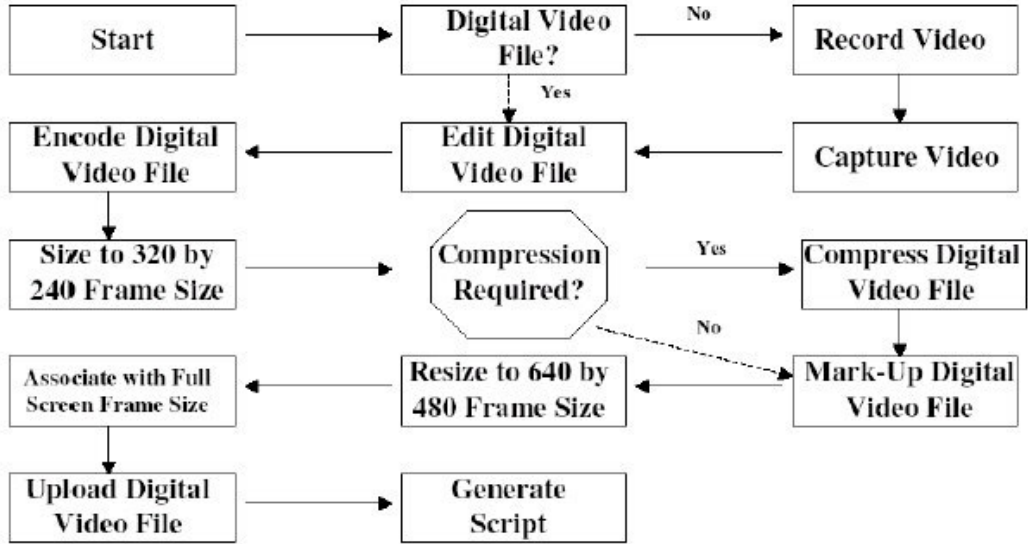



RESPONDENT AND MR. WHEELER S SUBMISSION OF VIDEO DISCLOSURE TO MR. JOAO

PROSKAUER ROSE LLP

2255 Greco Road
Suite 340 West
Boca Raton, FL 33431-7360
Telephone 561.241.7400
Facsimile in Florida
432.7749
Fax 561.241.7145

NEW YORK
LOS ANGELES
WASHINGTON DC
CLIFTON NJ
PARIS

PERSONAL AND CONFIDENTIAL

Fax Transmittal

Date June 1, 1999 Client-Matter 0894/40017/001

Total Pages (including Cover) 2
From Christopher C. Wheeler
Sender's Voice Number 561.995.4702

Sender's Room Number
Main Fax Operator 561.241.7400

To Ray Joao
Company Meltzer, Lippe

Fax No. 516.747.9363
Voice No. 516.747.0300.x240

Message

The attached is from Eliot Bernstein.

EB
561-47-4470

2025
Boni
35.6

Confidentiality Note: This message is confidential and intended only for the use of the addressee(s) named above. If it may contain legally privileged material, dissemination, distribution or copying of this message, other than by such addressee(s), is strictly prohibited. If you have received this message in error, please immediately notify us by telephone and return the original to us at the address above. We will reimburse you for the cost of the telephone call and postage. Thank you.

0894/40017-001 06/01/99 01:07 PM (2743)

06/01/99 01:07 PM (2743)



PATENT FOR VIDEO TECHNOLOGY

- > Step 1. Is to record the video under any format, beta, VHS, digital, any of the standard file formats. *VHS or digital, film camera, real-time, live broadcast.*
 - > Step 2. After the video is shot, the second step is to capture the video using any capture device and capture software. *Adobe Premier ~~PRO~~ VERSION 5.1 or Real Producer. 5.2*
 - > Step 3. Is to edit the video, if necessary, using any standard video editing tools. *Final Cut Pro*
 - > Step 4. Is to convert to real video format. *or Real Producer. 5.2*
 - > Step 5. Then we manually set the size of the video within the HTML code to 640 by 480. *Frame*
 - > Step 6. We then post to the Web using any Web FTP software. *WS FTP 4.00 or Ezy 2.00*
 - > Step 7. We then write an Ascii file that calls the real video to stream. This makes it a streaming real at full screen with very good clarity and quality. Under Step 7 we write a separate script saved as our *.rm (star.rm) file that will call the original real video file. This script is included in the HTML codes. For MPEG videos, we follow Steps 1 through 3 the same, then we, in Step 4, convert, if not already, to the MPEG format. 5, insert the video in the HTML codes and expand to 540 by 480. Then we upload the video file to the Web in Step 6. Step 7, this MPEG file is played from the Web by first downloading a small portion of the file and played through the necessary player or any player, actually, that supports AVI, MPEG-type video formats. *900 x 600, 1024 x 768, 1280 x 1024, 1600 x 1200*
- This tape was recorded on 6/1/99 at the law firm of Proskauer Rose LLP.

0894.40017-001 BR/LB/231287 v1

06/01/99 12:35 PM (2/43)

** TOTAL PAGE: 82 **



PROVISIONAL PATENT FILING 60/137,207 BY MR. JOAO UNDER SUPERVISION OF RESPONDENT AND IN CONJUNCTION WITH MR. WHEELER

PTO 5057 (Rev. 5-85)

PROVISIONAL APPLICATION FILING RECEIPT



UNITED STATES DEPARTMENT OF COMMERCE Patent and Trademark Office ASSISTANT SECRETARY AND COMMISSIONER OF PATENTS AND TRADEMARKS Washington, D.C. 20231

APPLICATION NUMBER	FILING DATE	PL. FEE REC'D	ATTORNEY DOCKET NO.	DRWGS
60/137,297	06/03/99	\$75.00	5865-3	0

RAYMOND A JOAO MELTZER LIPPE GOLDSTEIN & SCHLISSEL PC 190 WILLIS AVENUE MINEOLA NY 11501

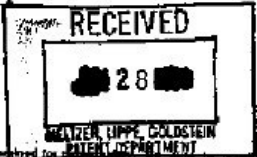

Receipt is acknowledged of this Provisional Application. This Provisional Application will not be considered for publication... Receipt is not to be used as evidence of the date of invention... Receipt is not to be used as evidence of the date of filing...

Applicant(s) ELIOT BERNSTEIN, BOCA RATON, FL.

IF REQUIRED, FOREIGN FILING LICENSE GRANTED 06/22/99 ** SMALL ENTITY ** TITLE APPARATUS AND METHOD FOR PRODUCING ENHANCED VIDEO IMAGES



Attorney Docket No. 5865-3

**APPARATUS AND METHOD FOR PRODUCING
ENHANCED VIDEO IMAGES**

The present invention is directed to an apparatus and a method for producing enhanced video images. A preferred embodiment of the invention is described in the following manner.

- Step 1. Record the video under any format, i.e., beta, VHS, digital, and/or any of the standard file formats, including, but not limited to, *.AVI, *.MOV, *.MPEG, etc., by utilizing an appropriate recording device such as a video camera, a film camera, a reel-to-reel recording device, and/or a live video recording device.
- Step 2. After the video is shot, the second step is to capture the video using any capture device such as a capture card or capture hardware, such as provided by Dazzle, and also by using capture software such as Adobe Premier version 5.1 or Real Producer G2.
- Step 3. Edit the video, if necessary, by using any standard video editing tools, such as, for example, Adobe Premier 5.1.
- Step 4. Convert the data and/or information obtained to a real video format such as, but not limited to, a *.RM format.
- Step 5. Manually set the size of the video within the HTML code to a 640 x 480 frame resolution, or any other suitable resolution, such as, but not limited to, 800 x 600, 1024 x 768, 1280 x 1024, 1600 x 1200.
- Step 6. Post the obtained file to a Web page, Web site and/or to the Web, by using any Web FTP software, such as, but not limited to, WS FTP PRO.
- Step 7. Generate or write an ASCII file that calls the real video to stream. This results in streaming real video at full screen with very good clarity and quality. Under Step 7 a separate ASCII file is written and saved as an *.RPM file, or other suitable format, that will call the original real video file. This script is included in the HTML codes. For MPEG videos, Steps 1 through 3 are followed as described above. In Step 4, the file is converted, if not previously converted, to an MPEG format. Next, the video is inserted into the HTML codes and expanded to a 640 by 480 resolution, or higher resolution. Then the video file is uploaded to the Web page Web site, and/or the Web in Step 6. Thereafter, at Step 7, the MPEG file is played from the Web page, Web site and/or from the Web, by first downloading a small portion of the file and playing the file through a suitable player which supports AVI, MPEG-type, etc., video formats and/or other suitable formats.

P:\PUBLIC\PATENT\BERNSTEIN\5865-3.APP

HAND NOTES OF MR. UTLEY POINTING TO MISSING ELEMENTS OF MR. JOAO S PROVISIONAL FILING UNDER SUPERVISION OF RESPONDENT⁴⁹

516.747.0653

3/9/2000

Guidance
BIN 1 2 F101

Ray Joao

Ray, there are major missing items in docket's 1 + 6:

1. Claims do not reference stitching
2. Process is ammended as shown on the diagram
3. The relationships between the enhanced digital image and the zoom and pan function together with controls is not clear
4. The description and claims stop at the production and loading of the image.

5. Object model Brian

⁴⁹ Supra Note 45.



See CD Folder for Audio Tape - Exhibits for Rubenstein - Exhibit H

**TELECONFERENCE TRANSCRIPT OF
JULY 31, 2000
PARTICIPANTS:**

- **DOUGLAS BOEHM OF FOLEY AND LARDNER;**
- **MR. BERNSTEIN, SIMON L. BERNSTEIN, MR. UTLEY, AND MAURICE BUCHSBAUM OF THE COMPANY;**
- **MR. WHEELER OF PROSKAUER**

CORRECTED VERSION - CORRECTED ON 5/14/2003
Transcription of Telephone Conference
Conducted July 31, 2000

Participants:

Simon Bernstein, Eliot Bernstein, Maurice Buchsbaum,
Brian Utley, Doug Boehm, Chris Wheeler

Note: Square brackets [] are used to indicate inaudible or indecipherable text. Text found inside brackets indicates transcriptionist's best guess. Since speaker names are not specifically identified, transcriptionist has made an attempt to identify based upon comments made in conversation but cannot guarantee that each speaker has been accurately identified. Note also that this recording has numerous instances of participants speaking at once or carrying on simultaneous side conversations that make it difficult to follow and transcribe the entire line of discussion.

Utley: <begins midstream>...status of the original digital image filings, and basically the fact that the original filings do not cover the full subject matter of the imaging technology; and to wit, one of the omissions, in particular in reading the claims section of the provisional and the formal filing, relates to the zooming and panning capability that is inherent in the technology. This has become a topic due to the fact that we are currently in the second phase of filing imaging patent protection which is driven by the provisionals that were filed later last year, between August and December of last year. So the concern that were expressed by Eliot in reviewing this is that this omission of the zooming and panning capability was attributable to a failure, for whatever reason, on the part of Ray Joao, the patent attorney of record, in constructing and putting together the provisional and formal filing<tape cuts out here> did I say it is that right Eliot

E Bernstein I believe so

Utley Is that your understanding

E Bernstein Correct

Utley The purpose of this meeting is to review the facts and I think there are two particular points that are ...that are important to moving ahead. The first is: "Given that the filings are what they are, and given what we know about the filing which is scheduled to take place this week on Wednesday, what means do we have to correct the situation; and given whatever corrections we find, what then is the impact or exposure to iviewit based upon what actions we can take. Then, lastly, what, if any, recourse might iviewit have vi sa vi the omissions in the original filings Are there any other issues, Doug?

Bernstein: Yeah, just correcting back to Ray Joao's work of the formal filing that he filed. Do we have a copy of that?

Utley: I do have that.

Bernstein: I don't. I've got the provisional and I've got...

Boehm: Everything is on the table

Utley: you should have...the formal.

Bernstein: This one?

Utley: Yes, that's the formal.

Bernstein: Okay.

Simon Bernstein: I just have one question. Does anybody have, or are we allowed to get, the files of Ray Joao?

Boehm: I have them.

Wheeler: Do you have all of the work that he had?

Bernstein: No, not all of it.

Utley: What was purported to be in the files?

Bernstein: And he also claimed to us that he destroyed part of his files.

Boehm: And I have some of his files. I have what was purported to be all of the firms' files.

<Inaudible comment.>

Utley: Well, there's a whole history, then, because I tried to get complete copies of the files originally, and found out later that not only did he not send us all the files, he didn't even mention that there was an extra filing out there that we didn't even know about.

Bernstein: This one that's in question.

Boehm: Yep

Simon Bernstein: You have no notes, no data on...?

Boehm: No, I have the application. I have things that you could get from the US patent office—that I could get from the US patent office. I have very few notes. I do have some scribbled Ray Joao's notes, but I think you gave me those notes.

Utley: I did. I gave you Bill Dick after Bill yourself[] the notes that I had.

Bernstein: And Ray's made disclosures to us that he destroyed the documents to protect us, which I don't know what he was thinking.

Simon Bernstein: Destroyed what documents?

Bernstein: Whatever he had in his files. Other patent copies, copies of the drafts as they proceeded...all that he destroyed to protect us from something I asked him to explain, and his reasoning...because I said to him, you know, usually you destroy documents when you are protecting somebody from something illegal or something. Have I done something that would force you to hurt me possibly? He said it was typical, normal, that all lawyers destroy their records.

Simon Bernstein: If that, in fact, is the case—I've never heard of a lawyer you know other than Nixon destroying anything the work is ours. Am I right Chris when we pay for a lawyer and we pay for the work, the work is ours.

Wheeler: The work product is yours. He may maintain copies of his files and everything; or his confidential notes to himself are not necessarily yours. But the work "product" is...

Simon Bernstein: Would you say that anything germane to the issue belongs to him?

Wheeler: Well, I mean if he wrote notes...in sidebars...yeah.

Bernstein: How about revised patents[]. How about copies? Works in progress

Wheeler: But things which would reinforce your patent, obviously, that is germane to the strength of your patent yes, you would be entitled to copies I don't think we disagree.

Bernstein: He's claiming He destroyed all faxes.

Wheeler: Can I ask you a question?

Bernstein: Yes.

Wheeler: Just so both of us understand...was this patent done prior to his flying down here, or was this patent done as a result of his flying down here and having discussions with you? I was under the impression that when he flew down here—this was before Brian came—I was under the impression that followed our meeting with Reel 3-D. I was under the impression that he was coming down to discuss, at the very least, the video aspect so that you could complete that; but were you also completing the imaging patent?

Bernstein: Correct.

Wheeler: So he went to your [kitchen]?

Bernstein: Right. And we spent days there

Wheeler: And the two of you spent all the days...

Bernstein: Correct.

Wheeler: And did he, in front of you, write notes?

Bernstein: Tons. Hundreds

Wheeler: And did he then produce them on his computer and type out certain things?

Bernstein: Yes.

Wheeler: I was under the impression he was doing that with you.

Bernstein: He did.

Wheeler: And did you read those?

Bernstein: I did. I did - now going to that same nature, that's the provisional I think we're talking about...

Wheeler: Right.

Bernstein: But he flew out here again with me and Brian and went through this as he went to file this--this is a 3/23/2000 file--that also fails to make mention of.

Wheeler: So that's the formal file...the formal one?

Bernstein: The formal file. So both also missed the point.

Wheeler: I just wanted to know and to put things in proportion, when you read the provisionals, because Brian wasn't with the company right now and then, and when there were all those drafts, because obviously we didn't see them...

Bernstein: Well, you saw because we gave you all the documents. I'd get a document from Ray and bring it to you so you would have records of everything up to that point because I didn't want to keep them at my house.

Wheeler: The final...the final...but I'm not reviewing the patent. I was keep maintaining it as...

Bernstein: Okay, but you have every record...

Wheeler: Everything you gave me we maintain. We don't...

Simon Bernstein: Any notes should be produced...

Wheeler: We don't throw away anything.

Bernstein: Yeah, I know.

Simon Bernstein: I know you don't you're very thorough.

Wheeler: So, I'd file it away; so if you gave it to me, it's in our archives.

Bernstein: Right.

Wheeler: I wanted to know, when you read those drafts...

Bernstein: Oh, it was...it was clear

Wheeler: Answer my question...when you read the drafts, did you see the panning and scanning elements?

Bernstein: Yeah, and zooming, up to 1,000 times we thought it was. That was the big...you know, we had it in there...as a matter of fact, he just said it...somewhere it's in there up to 1,000 times, isn't it?

Utley: 1,700.

Bernstein: Right. That was our old mistaken a number of times. So, yeah, for him to miss that, Chris, would be the essence of stupidity.

Wheeler: So it was in there?

Bernstein: Absolutely.

Utley: The zooming, it was in the body, but not in the claim.

Boehm: But a provisional doesn't really...doesn't have to have claims.

Utley: It doesn't have claims.

Bernstein: But then in our claims of our patent, it's not there. This is what you're representing, correct?

Wheeler: So you're saying that it wasn't put in the file, but it was put in the provisional.

Boehm: No, I could see where he's going to argue that it's there.

Bernstein: Let's see. Let's take a look.

Wheeler: ...what the language of the patent claims are that he filed.

Bernstein: Okay, let's see what he...

Wheeler: And this isn't the final decision because I can go back right now and amend those claims.

Bernstein: Wow, yes, but we have elements of exposure that creep in correct?

Wheeler: I'm just telling you the whole thing, then we'll go back. So you did look it over, and there are no claims in the provisional?

Boehm: There are no claims in a provisional. You can file them, but they are never examined.

Wheeler: But the zooming and the panning and the scanning element was incorporated in that?

Boehm: Go ahead, Brian.

Utley: Let me make sure that we say that properly. The provisional filing had a claims section which migrated into the final filing, but Eliot is correct in saying that the provisional does not need a claims section.

Boehm: The provisional never gets examined, so it doesn't need the claims. It just holds your place in line for one year.

Bernstein: But then when I look through this...

Simon Bernstein: Hold on, Eliot, I need to understand this. What you're saying, then, is assuming any negligence on his part, to that point the negligence doesn't become realistically damaging to the company until since he actually made a claim...since he actually made a provisional filing. Which took our place in line.

Boehm: If the provisional filing covered the invention, your place in line is only as good as the subject matter described in accordance with the law.

Simon: Obviously, it should have had the panning and zooming in there.

Boehm: Well, the word "zoom" is in there.

Bernstein: But not really to describe what we're doing.

Boehm: But do you see what I'm saying? It's only to the amount of subject matter that and attested where the average person skilled in the art could make and use an invention as it's described in this document, and without "undue" experimentation, without inventing it himself.

Simon Bernstein: Right.

Boehm: Now, this provisional application, you throw it...different patent attorneys do different things with it. On one end of the spectrum, you do an invention disclosure. Most big corporations have invention disclosure forms which leads the inventor to write out good disclosures and figures and things, and I've seen people actually file that invention disclosure because if you're coming up on a bar date, you don't have time to write an application or think about what your invention is. All you've got to do is get something on file, and then hope that it will protect...that whatever you had on file covered your invention.

Simon Bernstein: Is that what we've done so far?

Bernstein: No.

Boehm: I don't want to answer that, but that's the line.

Boehm: It's a grey question, it's a grey area, I think.

Wheeler: That's what we're aiming to do, that's what we're hoping to do.

Boehm: But on one end of the spectrum, you file very minimal work, and that's what Ray did on some of the applications, like on the one...

Wheeler: He was trying to do it in a broad...

Wheeler: He did say conceptually that his method was to do a broad stroke of it.

Boehm: Right. Well, a broad stroke on drafting the claims.

Wheeler: Okay. Right.

Eliot Bernstein: He's got to put the invention in!

Boehm: That doesn't happen in a provisional at all, generally. If you want to, you can write the provisional claims just so you know what you're doing, and it's actually used as subject matter; but the claims are never examined. It doesn't matter if it's in proper format or anything, it just sits there. Now, if you pick up the provisional a year later—it has to be within that year—if it's a real well done application, you just file it. There's no money involved in turning the provisional into a regular filing. Oftentimes, with these one-page disclosures, there's a substantial amount of money involved in taking that from there to there. The problem is you cannot add subject matter to the patent application later on once it's filed.

Bernstein: Unless it's really the patent application, correct?

Boehm: No, the subject matter has to be supported—has to be described—

Simon Bernstein: In the provisional.

Boehm: Uhhuh To that text, or you lose your filing date.

Wheeler: But the zooming element, then, is not in addition.

Boehm: Is not in addition? You mean...

E. Bernstein: It's not even in there.

Wheeler: You can't add subject matter. So if he did describe zooming, then it's not in addition.

Bernstein: Did he, ?

Wheeler: I am asking you whether he did or not?

Boehm: I'm not clear on what you mean. You can't add additional subject matter after the filing date of an application or you'll lose the right to that filing date.

Wheeler: The provisional? You can't add subject matter to the provisional?

Boehm: To any application...any patent.

Wheeler: But if he did describe the zooming, then the zooming element is not an addition in the formal.

Boehm: Right. It's supported. If he described it in the original, you can base claims on it later.

Wheeler: And have we said that the zooming is in the provisional?

Bernstein: Nowhere that I can see.

Simon Bernstein: Wait. You're the lawyer reading another lawyer's work. Is it in there?

Boehm: Do you have a copy of it?

Bernstein: Yeah, right here. It isn't in there if it bites you.

E. Bernstein: It's not in the filing either.

Simon Bernstein: It's obviously not in the filing if it's not in the provisional.

Bernstein: No.

Simon Bernstein: Can you make reference to something...let's say he uses the word "zoom".

Boehm: Exactly. I'm pretty sure the word "zoom" is in there, isn't it Eliot?

Bernstein: But what Doug's saying is that had you written the patent, you would have described the invention as the ability to do this cool zoom that we all...and just said this is the cool part of what we're doing. What Ray's missing in the outline is the ability for you to put a picture on a Web page.

Wheeler: He did know that an important element was the fact that when we went in and made it bigger, we didn't pixelate.

Bernstein: It didn't pixelate. Not in here at all.

E. Bernstein: Not even mention to that concept.

Bernstein: Complete failure. It's not.

Wheeler: But if said it doesn't distort when we zoom...

Bernstein: Nope. Nothing like that.

Wheeler: That's the same thing, isn't it?

Bernstein: Yeah, but he hasn't said anything...he doesn't even tell you ...

Wheeler: What about the panning element, or is that element not patentable?

Bernstein: No, that's part of the whole process is to be able to zoom while panning.

Wheeler: Here it is. "The above process can be utilized in order to create higher zoom capabilities with each new depth layer of an image..."

Bernstein: No, but that's a new depth layer which is bringing in another hotspot image, so it's really a completely different subject.

Boehm: Oh. Okay.

Boehm: Okay. Where is that?

E. Bernstein: I read it to, he's very crafty you know.

Boehm: "Where the zoom capacity of up to 1700 times or greater may be easily obtained with the [present conventions.]" Are they talking about the hotspot now?

Bernstein: No.

Boehm: No, it's the general zooming capability.

Wheeler: So it's not in addition.

Bernstein: Well, explain to him where it's missing.

Wheeler: You guys didn't put it in the formal...I don't mean you...he didn't put it in the formal one in the depth in that what we want to do it but he could have without it being construed as an addition.

Boehm: Yes.

Boehm: Well play lawyer on you now<Laughs; cannot understand his comment.>

Wheeler: Right - sorry

Boehm: Whether or not it's supported is a question that's going to be determined either between you and the examiner...probably not, it's between you and another

lawyer someday when the case is litigated. The question is And again, the test is: Can the average person skilled in the art—the average designer of this type of software—can he read this document and make and use of your invention without inventing it? That's the test. Now, whether he uses the word "zoom" in here and "magnification" later, that doesn't mater as long as he would have gotten it. If it is so simple to build by reading this, you don't need any subject matter. If you're combining three elements A, B, and C, and A, B, and C are standard in the art, and you tell them these are standard in the art, go combine A, B, and C, that could be a one-page application. The average person will pick it up and he could. It's a patent test. Are you with me? The more complex it is, the more you want it supported in this text.

Simon Bernstein: What if it is basically simple, and he just wrote it as basically simple, does that support our position anyway though?

Boehm: Does that support our...Sure...

Simon Bernstein: I mean, if we were to litigate against another person that infringes on our...

Boehm: An infringer.

Simon Bernstein: Supportable for the sake of argument?

Boehm: Right. Yes. That is a fair argument

Simon Bernstein: OK so then I don't know that, at least from first blush

Bernstein: That's the provisional you're reading though, right?

Boehm: Aren't they the same? I think they're identical, aren't they?

Boehm: You can check in his notebook.

Boehm: Are there differences?

Bernstein: Where did you find that piece that you just read?

Wheeler: Is the reason...now continue answering my question...is the reason we came to the formal in March of this year, which I didn't realize that Joao. I thought that we had agreements for doing everything, but apparently Joao filed...

Boehm: For that one, yes.

Wheeler: But he didn't bother telling anybody.

Boehm: That's the one that we didn't find out until way late.

Wheeler: Okay, perhaps the reason that he did that was that was the easiest way to do it and the course of least resistance, and he thought he could go back...is there an amendment procedure?

Boehm: Yeah, there's an amendment procedure.

Wheeler: That he could do it a few months later or something like that?

Utley: We had a conversation before the formal filing, and, in fact, I have my notes here from that conversation.

Wheeler: Okay.

Bernstein: And you mentioned that there was no zoom.

Utley: Yeah, I said...

Bernstein: Claim one.

Utley: Yeah, Here are my notes. This is my original copy. Claims do not reference stitching. The patent app does not cover providing enhanced digital image with zoom and pan controls. It covers for creating enhanced images to show zoom and pan functionality without distortion." Those are my notes.

Bernstein: And you told him that.

Simon Bernstein: Here's a man that was cognizant of what was necessary to be in there. How did a guy to file a patent without any of us—obviously, not me, but Eliot, Brian.?

Boehm: Jim wasn't around yet.

Simon Bernstein: Okay, but Chris was and so on and so forth—how did they get through the crack that he did this?

Wheeler: It didn't get through the crack. Brian addressed it with him.

Bernstein: And everything is shredded now, too. Everything else is shredded.

Utley: Kind of what he was going to do—his time factor—he was going to...he didn't think he would get this in. He would submit it and then would turn right around and amend it.

Boehm: Did he really say that?

Bernstein: Yeah.

Utley: I wouldn't say amended, it was because of the stuff that was coming...

Bernstein: It was supposed to be in there.

Utley: ...he was going to smash that all together and file it.

Simon Bernstein: Was that the same time, Brian, that he was leaving the firm?

Bernstein: Yeah.

Simon Bernstein: So would you say that probably...

Utley: he knew at the time that he probably would be leaving?

Utley: Right.

Simon: But he wanted to get all of this in place so he could do the billing and get that part of it in...

Utley: I don't know that.

Boehm: Just speculating.

Eliot Bernstein: What day did you give him those notes?

Simon Bernstein: I don't ever have to speculate on billing

Utley: I don't have my address book with me...I didn't write the date down, but it was the date that he was here. He came.

Wheeler: He wanted to get it done to take care of you, make sure it was filed for you.

Simon Bernstein: That could be too. One other reason is...

Wheeler: We're just speculating.

Wheeler: And I'm not trying to... <Everyone talking at once.> I thought he was trying to work on our best behalf, but one time or two times that I met him, it seems like he was earnestly trying to help. Who knows? Maybe he was incompetent. I mean we're only suggesting that it would have been incompetence

Bernstein: Well, the fact that it's not in your patents, right up front, this is the invention, is a gross neglect. And the fact that it doesn't say, "this is what the invention is trying to do. This is the feature..."

Simon Bernstein: The point is not whether it's gross neglect or not, it's what the damage is if there is...if, one, gross neglect is of any import; and two, what is the damage? it has caused iviewit. That's what I think we need to ascertain here, and if we can ascertain it.

Utley: How do we fix it?

Simon Bernstein: Of course lets try to fix it, if we can't fix it then we'll worry about...

Eliot Bernstein: Well 1st lets fix it

<Everyone talking at once.>

Boehm: Let me go over the procedures so everybody's clear. Again, on one end of the spectrum you file a very sparse, like a one-page provisional application, and it's cheap, and the purpose of the provisional is to get you in line...it is to protect your date. What you're trying to do is get the benefit of your priority date. When you invented it. When you're in line in terms of whose the next guy that invented it. Whose the first inventor?

Simon Bernstein: Someone comes after you the second day after...

Boehm: Who's the first inventor, that's what you're after.

Simon: I understand. I really understand...you don't physically stand...

Boehm: Not physically in line in the patent office is right, not or even in physically in line in order as well. Okay. One-year letter, the provisional expires and you have to file a non-provisional patent application, okay? Many times it's identical. If you do a good job up front, you just file that, but you need to put claims on at this time. When I do a provisional, I try, if there is money and time up front, to do it once up front. I even write the claims. As a matter of fact, I don't even like to file provisionals because there's not much of an advantage. If you've got the time and the money up front to do a good job, well then, just file it as a regular application.

Simon: Understand that at the beginning, the time and the money...I mean, the time was certainly available, but the money was a short substance. So it was obvious that Ray would be working in a most expeditious way.

Boehm: Well, that's why the..

Simon: Which might have short-circuited us because of all of the lack of funds.

Wheeler: Well, that's true because the filing date is 3/24/99 to endorse that...that was very early in the game.

Simon: We did it in your office Chris in your library...in your conference room. The only meeting I had with him was while we were going to file the patent and that was in your office.

Boehm: Okay, 3/24/99 is the provisional application.

Bernstein: That's what I'm saying. Well, Chris,

Boehm: So even at a year, he filed the second one with claims.

Buchsbaum: Yeah two things happened during the year. One, the Company was doing other things, even though they knew that was coming up, and two, I guess there wasn't a whole lot of money to allocate towards doing that much.

Simon: Here's what we did. We hired Ray Joao on the monies that were raised by the investors; and then when Huizenga was coming in with their money, and when that money came in, we made a company decision that the first and foremost thing was to get the patent filed properly. So the fact that we were going to spend more money and get them completed at that point had already been made.

Simon: Okay, but prior to that, we were working on short forms. Then after that, we started to raise capital, and we always knew that the priority was intellectual property, so were going to make sure that those got done right. Brian's been working on it ever since, and I felt comfortable...I never did feel comfortable with Ray Joao...just an observation.

Boehm: Hmmm...is it all patent attorneys? <Laughter>

Simon: No, no, there's nothing wrong. He came in, he's a nice guy, he tried hard, you know, all the nice things, but his work always appeared sloppy, okay? And that's the only thing I can say. You're a patent attorney, you see what he did. If I'm wrong, then let me know; but to me, it looked like it was a little slipshod. And then he made some statements that really bothered me, too, that I don't think he should have made to a client, and that is that he was filing his own patent. <Chuckling.> I mean, horseshit personally, I haven't heard of a patent attorney in my life telling me that he's an inventor filing his own patent. It really did bother me.

<Everyone talking at once.>

Bernstein: Transmitting video files on a communication network for airlines and...

Simon: It probably meant nothing because I don't think the guy was of the nature to be stealing from us, but I don't know! But I'll tell you this, it did ring a bell. From a pure novice, it made me a little nervous. I asked Eliot why he was dealing with somebody, but we were assured that this was a good firm...

Boehm: Let me look back in my own spiel...here with the provisional. You file a provisional, then within one year, you file a regular application with the claims. You can add claims to it; but if you add subject matter to it—in other words, if the zoom and pan concept wasn't well described, you have lost the benefit of that first phase. Right. Now

why is that going to hurt you? Two main reasons. One is if you put it on sale—offered it for sale— or you publicly disclosed it, there are certain regulations that say you've got to get something on file, so if you had publicly disclosed it, that would protect...getting the application on file will protect you from losing your date because of public disclosure and offer for sale. I think that's what he was trying to get the earlier dates for.

Simon: Sure.

Boehm: I spoke with Ray when I was trying to get all of these files, and his comments to me were...when we were on the phone—you remember, we were asking him where was this stuff, and he said, well, he kept building on and he learned more it got in there. After I reviewed these applications, I agree that you're learning more as you go along. I'm doing the same thing. So it's kind of a learning curve.

Bernstein: If they ever find a zoom description that adequately makes...especially in the claims...I mean, if you're reading the claims...

Boehm: But Eliot, he's going to say that the claims are of no import right now. All you have to do...

Bernstein: In the filings?

Boehm: In the filings. I can go amend those right now. We can sit down today and re-write them.

Simon: If it can be amended amend it. There's no problems.

Boehm: There's no problems.

Simon Bernstein: There's always maybe a little money that's been duplicated and that's it.

Boehm: Here's the problem, and that's what I want to get across about that. If he's trying to claim zoom and pan and I rewrite the claims to claim zoom and pan, and the examiner says, that's great, but it's new matter

Bernstein: But it's in the provisional that you can zoom up to 1700 times.

Boehm: If my claim is supported by the spec on that date, then you're fine.

Bernstein: Isn't it?

Boehm: I can't answer that without going into the...

Bernstein: But when we read the provisional and we see that, it says...

Simon Bernstein: Before this meeting took place, before we called this meeting, aren't you privy to everything that's been done?

Boehm: Oh, sure. I have everything.

Simon Bernstein: So when Eliot asked you that question, why can't you answer it?

Boehm: Because there's no...in my opinion, there's no clear-cut answer, yes or no, on the quality of the work product. It's a judgment call.

Bernstein: So that's an exposure, and what if the judgment is against us?

Wheeler: It's [an examiner] judgment call is what we're saying.

Boehm: The damage?

Wheeler: No, the examiner. <Everyone talking at once.>

Wheeler: Whether the subject matter is new or not.

Boehm: The examiner would...hold on...it's...

Wheeler: whose judgment call is it?

Boehm: It could be the examiner's, if he catches it. If it's not caught, and you get it to patent and you litigate the patent, ... at court. Or if the examiner catches it and I want to appeal it to the board of appeals in the patent office, it's their judgment call

Wheeler: Okay, so we go to court and we're fighting over the patent, we would argue that it's supported by the zoom 1700 in our language, and the other side would, say that's baloney that's too broad you didn't describe it enough

Boehm: You didn't have your invention...

Bernstein: Then you lose.

Boehm: We would lose only if you had a bar date come in there if somebody else invented before you, or if you put something on sale...or if we offered something up for sale.

Bernstein: Which we did.

Boehm: But the offer-for-sale date from our first meeting is not until September.

Bernstein: Right.

Boehm: So the offers for sale won't normally kick off a foreign...

Simon Bernstein: Could you explain to me what offer for sale means?

Boehm: Sure. As soon as you...you can't get a patent on a product after you've been using it for more than a year. As soon as you publicly disclose your invention, you've got one year in the United States to get a patent on file, okay? Even if you don't publicly disclose it...let's say I've got a method of making [] in my factory, but it never gets outside. I'm starting to commercialize it, I'm making money off my invention...the commercialization date a year later is you can't patent it in the U.S. So that's that one-year grace period.

Simon Bernstein: Aren't we within that period?

Boehm: Yes. As far as we know, yeah. As far as we know.

Utley: Yes-yes we are within that grace period

Simon: Okay, somebody explain to me, what am I doing here? Why am I sitting here? Are we saying that Ray Joao, other than being sloppy, but there's not much damage that could have been done or can be done because we can fix it, which really would make me the happiest to hear that.

[not in transcript: PSL look at change above although minor it indicates perhaps the change in text to match new text]

Utley: Can I jump in? Let's just say there are two steps. We're going to make a filing this week; and to the best of our knowledge, we have swept up all this in this filing, and that will be within the commercialization period. The second thing that we're going to do is we're going to look at filing an addendum to the original formal filing to strengthen the claims - broaden the claims ... to the maximum extent that we can.

Boehm: if we need it...if we need it.

Boehm: It'll be a lot of this was swept up into the application.

Utley: What we're trying to do is protect the date day of March 24

Boehm: The original...

Utley: The original date as March the 24th, but filing should remain an objective.

Simon Bernstein: Brian, if you broadened the language now, would that be a red flag to the commissioner that you should have done it earlier? Or should we just say that this has always been there?

Buchsbaum: You mean the examiner of the commission

Bernstein: We're not going to be able to say it was in the claim.

Simon Bernstein: What happens when you start those amendments or broaden them is you start to admit that you didn't do it.

Boehm: Um, yes and no. We...I do that all the time.

Simon Bernstein: It's common then?

Bernstein: If they do it all the time, then we have to do it.

Simon Bernstein: But not until I feel more comfortable with it.

Boehm: We normally have a search done. The patent examiner will do a patentability search, and he will come back and reject it. The problem is if the claims are too narrow to begin with, he will not come back and reject it, he'll allow it, and boom! Now I can't amend it he's in. [], we're done. But I can file an continuation on it. I can keep dragging this out and get broader claims as long as the subject matter is...

Wheeler: So that's why he stated it broadly versus narrowly?

Boehm: No.

<Somebody comes into the room to take food/and or drink orders.>

Boehm: No, but as far as, doing it broadly, if you're saying to claim it broadly it's our job to claim... as prior art which I doubt the claim is as broad as the [] allows...

Wheeler: Right. That's what I'm saying.

Boehm: And this is claimed broadly.

Wheeler: Right.

Boehm: And that's the normal tactic, to claim things broadly, and then wait for the examiner to come back and say, "Oh, you can't get it that broad," and then narrow down your claim.

Wheeler: Okay, so isn't that what he was in part trying to do? That's what he's been saying, yeah.

Boehm: Yeah.

Wheeler: Well, would that not be consistent with how patent attorneys try to do things?

Bernstein: Well, claim one, if you look at their claim one, Chris, that they've written, it identifies...

Wheeler: Who's they?

Bernstein: Foley & Lardner. It identifies what you're trying to do. [not in transcript: Stephen note how Dicks name is deleted and Foley's name is screwed up, may indicate who was changing this transcript]

Wheeler: Okay, so maybe it should have been written differently.

Boehm: You won't get two patent attorneys to write the same claims.

Bernstein: Well, no, but you try to write the claim, and that's the teaching you and Steve both represented us here, to describe in its broadest term...

Boehm: Right.

Bernstein: ...the invention.

Boehm: Well, I can't say that this isn't broad. This is very broad. This might be rejected for indefiniteness...I don't know what it is...but now he's got the opportunity to go back and...

Bernstein: And Brian, you know, there's print film image in here, it's all supposed to be out of here.

Wheeler: What you're telling me is that in your forum of law there's always going back and refining and refining and refining that was wrong.
<Everyone talking at once; two different conversations going on at once.>

Bernstein: This is like he just completely ignored what we said over a year. He didn't do a thing. Nothing. No comments, nothing.

Utley: Almost nothing between the provisional and the formal process.

Boehm: And some people intentionally file narrow just to get something on file. Then they can come back and repair it without damage to it.

Bernstein: But you don't know that because an examiner...

Simon Bernstein: You'll never know that until you have a litigation.

Bernstein: And then the question is what potential damage does that...

Simon: That damage potential and that remedy will be then taking place at that time, not now.

Boehm: That I agree with. Even if we decide something now, you won't know what the outcome is for five and a half months.

Simon Bernstein: ...wouldn't happen anyway. You wouldn't even know that.

Utley: Let me come back where I was. We are going to file on the 7th, Wednesday. As far as we know, that will cover every element of this invention that we have our arms around at this point in time.

Boehm: I believe so, yes.

Utley: And we should go back and address what amendments we can make to the claims in the filing of March this year and determine within the spec of the filing how broad those claims can be. I mean, that's going to be the test. Within the spec of that filing, how much leverage have we got to broaden those claims so that we do have a priority date which is back about a year ago last March.

Bernstein: So we want to insert everything going into this one into that one?

Utley: No, it'll be...

Utley: It'll be based upon the preamble, if you will, of what's in here.

Boehm: We do reference it. As a matter of fact, this is the cover page, Brian, of the application we're going to file.

Utley: Yeah, you reference it right there.

Bernstein: But you can add claims to that one that you're referencing that would encompass what we have in today's filing, which is really...we do want it in there.

Boehm: Yes, I can claims to the zoom and pan to get you back to the original date in this one since I claim to this onto his.

Bernstein: Well, we should do both.

Boehm: Well, you can't get two patents on the same invention, so it depends on where we want to go.

Bernstein: Well, we want to definitely get it in on his because it gets us an earlier date. Correct?

Boehm: No. It's a mess with these dates. What will happen is...nobody will worry about the date unless there's an occurrence, and that occurrence might... it's a major problem. You won't find out about that occurrence until you sue somebody, and then they go search in Australia, and they find a reference that somebody's done this before in the library, and then you worry about the date. Were you before him?

Bernstein: Well, that's what I'm worried about. I'd like to go back to our earliest date.

Wheeler: Can I point out one other thing? I know we look for the word...Eliot looks for the word...I know we look for the word "zoom," but there's also other language in here too. Sometimes we get caught up in a word "zoom," when what is zooming other than enlarging or reducing? And he does have language in here, "when enlarged or reduced, these pixels of the digital image becoming distorted a feature which

typically results in the digital image being fixed to an original size or being available at low magnification, such as, for example, magnification from 200 to 300 times. These digital images are also difficult to enlarge to a full screen without a tremendous amount of distortion present in the end product."

Wheeler: I mean, he's describing I mean that's zooming. Reducing and enlarging is zooming.

Bernstein: But he's not putting it in your claims, that's what he's saying. You see, this is different.

Boehm: But it doesn't matter right now

Wheeler: But it doesn't have to be if you've made mention. The opinion is that it doesn't have to be as long as he's ...if you made mention...if you've gone on record of having described this

Boehm: This is the background that's...problem. He's got...

Boehm: That kind of invention, right, it's got to state...

Wheeler: Well, I didn't get to that either.

Bernstein: Right. And that's where it's not.

Boehm: I pointed out a couple of things. It's not as...

Bernstein: Within the claims, the claims I'm reading, you could not...

Boehm: The claims really don't matter.

Bernstein: In the patent?

Boehm: The patent claims on a pending application basically don't matter.

Bernstein: No, the ones he filed.

Boehm: Yeah, they basically don't matter. I can go back and change them.

Bernstein: Okay. Why? So we want to change back to the original one he's filed, put as much language as we can that we have today...oh, it's all supported. Everything you wrote in that new one is supported in this one because it's the same process.

Boehm: That's the ultimate problem that Steve and I—Steve is Becker, the other patent attorney that actually wrote these patents <in audible>—but that's the ultimate problem that we're worried about, and that's the problem that you always worry about unless you first of all have a handle on the invention, inside and outside, and second of all, unless you really have a handle on Prior Art so you know where you

want to go with this. Then you spend the time and the money to do a good original provisional filing. You've got a pretty good shot that it's supported then. But when you file as, oh, I've got to try and cover this base, and when you do this kind of stuff, there's always going to be a question of what was supported when.

Bernstein: But that's fine. It is supported.

Simon Bernstein: We're off the subject matter.

Bernstein: So we should definitely claim back to the earlier date?

Boehm: We may get a rejection, or you may find out in litigation five years from now, that none of this was supported. Some court may say that you never talked how to do this because your software wasn't in the patent application.

Bernstein: It is, though.

Boehm: Well, the code isn't. They might say that these broad diagrams and these flowcharts aren't good enough. There's always that risk.

Bernstein: But we're trying to say that if they accept it, we want it to be to the furthest filing date that we can, which is March 3, 2000, and that's where it should lie; and if it's going to get argued let it live or die at that date.

Boehm: That's what we're trying to do right now.

Bernstein: Okay, good. So I'm under the impression from this point that we're going to encompass what we've learned what we're filing even in this other one even into the original one so we can claim back to a March 3 filing date that claims back to our original March patent...

Boehm: March 24th, yeah, all of that will go back toward what is supported in here, in the original. Not supported in ours.

Bernstein: Okay. And it's all going to be supportable because you're going to be able to pull up an image of the nature that we are discussing, and anybody with an eye can see that you've now done this.

Boehm: <Inaudible comment.>

Bernstein: Well, you're going to be able to show your invention, aren't you?

Boehm: No, no.

Bernstein: You can't?

Boehm: You live or die on what's in the specs. That's why...

Bernstein: Then get it in there.

Boehm: Yeah.

Bernstein: You can't bring it in as evidence what the invention is?

Boehm: Only outside evidence of what the average level of skill in the art is, okay? If somebody says that the flowchart isn't detailed enough, I'm going to go, "Oh, yes it is. Here's 29 programmers who are going to testify and say yeah, I can do that in my sleep with this document." So, there's always going to be a battle about the level of support.

Simon: Maurice and I—that's why I asked him to come in—Maurice and I were talking because neither one of us understands patents or how you file them or invention actually. What we do understand a little bit about is the theory in business; and now that we know that Ray Joao was somewhat sloppy—I'm not suggesting that he's not a fine attorney or anything else—you have been...you have reviewed all these patents that we have, whether there are eight or ten of them...

Boehm: There were eight original filings, and then...eight original filings.

Utley: Okay. And then how many do we have now?

Boehm: Let's look at the chart right now, but it's basically. We've got 17 applications that have been filed. These old ones are dead now because they were provisionals, and we've basically covered all...we pointed out basically covering two, maybe three inventions, so there's not...I mean, if we were to start over, maybe you'd do this with two patents, maybe one patent. So.

Simon Bernstein: Who owns them?

Boehm: Who owns it? iviewit Holdings, Inc.

Utley: Owns all of them?

Boehm: Except for...<Pause, and then text comes in that doesn't seem to be answering this open question.>

? Video playback over a network

Wheeler: How did he get in? [not in transcript but this refers to Jeff Friedstein on an invention]

Bernstein: He's part of the invention.

Boehm: An inventor - inventorship.

Boehm: So I've so I've got a document right here for him to sign. If he signs, then I do a couple of things.

Bernstein: He signed that when you faxed it to him originally.

Wheeler: I have copies of each one of these. Can I get a copy of your []?

Boehm: of this? Sure.

Wheeler: I have a copy of each one of these, I believe, or most of them...

Buchsbaum: Can I ask you a question? Your saying everybody that has an obligation to sign is on the list of names in these patents?

Boehm: You preferably don't...well, unless you have the new ones...

Wheeler: I don't have the new ones, but...

Bernstein: That's an old one. That's old.

Buchsbaum: You're saying everybody that has an obligation to sign is on the list of names in these patents right, because the company was part because the Company was doing, is that what you're saying? Because I don't even know if everybody has signed because you may due corporate due diligence for financial reasons or if...and they will say has everybody signed off on these patents, and if three people don't...if one person hasn't, he has an obligation to sign?

Boehm: Brian, have you signed?

Buchsbaum: Has everybody signed off on these? Brian?

Boehm: See these tabs [refers to tabs for inventors Bernstein, Shirajee, Friedstein and Rosario to sign] right here? That's what I'm trying to do today. As soon as...I'm going to have people sign, me sign...all the inventors sign. I've got to get a hold of Jeff

Bernstein: I thought we did that when we filed.

Boehm: You only signed one real document, didn't you? Did you actually a declaration? I know you didn't sign an assignment over but you're real clean on it because these are all based on the original filing , which is assigned to iviewit holding already

Bernstein: What's that mean?

Boehm: So all of the other inventors would have a helluva problem trying to say they owned anything.

Simon: Again, this is a little off the subject matter, but I have asked Chris about it before. If something were to happen to iviewit, and it were it went into bankruptcy, what would happen to those patents? How would those patents []?

Wheeler: It depends on which at iviewit you're talking about.

Simon Bernstein: The one that they are held in.

Wheeler: Well, first of all, holdings is held separately versus...we're operating the company out of a separate entity, correct? iviewit.com. So, let me think there...

Buchsbaum: The operating company is iviewit.com.

Simon Bernstein: All I'm concerned about is, for example, that the largest creditor...it wouldn't be a creditor, it would actually be an investor...would then...

Bernstein: They're not a creditor.

Buchsbaum: Okay, then the largest creditor could come in and pierce the corporate veil of iviewit.com and say that this is just a way of protecting the only valuable asset of the company away from creditors. Is there a possibility of that?

Boehm: Obviously there is.

Wheeler: There is a possibility, but that's one of the main reasons... But the loan, they made the company who wrote the patent, join in as a guarantor anyway on it.

Bernstein: Well, that would be all of us. All of those would be all of the investors getting a piece back?

Wheeler: No, no, no. On the \$800,000 loan, those people, it's secured by the patent.

Simon Bernstein: What about the \$600,000...or the other \$800,000 loan?

Wheeler: The others weren't loans. The others were equity, as I recall.

Simon Bernstein: No, no, they have claims.

Bernstein: Well, they're supposed to be converted to equity, which is another issue.

Utley: But there where note holders

Wheeler: No, because there was no quid pro quo at that time. The note holders I mean you can't go back and do it, we had that talk Si

Wheeler: I mean, you can't go back...

Bernstein: The note? I believe they're not final, even though we told people they would be by this time.

Wheeler: The note holders took their money in without taking security. Now you...<Indecipherable. Everyone talking at once.> ...new considerations...I said now you can't ... back to a failure to the corporation

Simon Bernstein: ...Board if everybody that was a creditor found, everybody that was a note holder at that point there was no what would you call it - problem

Buchsbaum: and that would be protected by the courts anyway usually. The court would see this probably as a you know a fraud

Wheeler: You could have two frauds: fraud of creditors and fraud of shareholders.

Simon: No, Chris I'm not worried about fraud. I'm really concerned with the fact that what we did here, the last loan that we took in, from...

Bernstein: Crossbow.

Simon: No, not from Crossbar...

Bernstein: Crossbow.

Wheeler: Crossbow

Simon: ...is secured by the...

Wheeler: ...the term of the deal, right.

Simon: And that's perfectly acceptable to me except that everybody else that had loans prior to that at that time should have been considered with the same equity because ...posses able and Chris told me that that was the perfect time to get it done

Bernstein: Yeah, but would Huizenga lose his?

Bernstein: Would Huizenga lose his stake in it to Crossbow?

Wheeler: No, no, no, it wasn't...I said that if there was going to be new considerations from those people, we all could of...??

Simon: We all could have put in another \$10. I mean, at the time we did it with Crossbow, we should have made sure that our other people...

Bernstein: Are protected.

Utley: No, no, no. We would have had to issue new contracts out for everyone.

Wheeler: There would have had to have been some material consideration, not just \$10. It would have been...

Simon: So it would have been \$10,000...

Wheeler: Well, then, you could have...Crossbow, we didn't even talk about Crossbow at that moment, and I said you couldn't go back and just collateralize. You couldn't go back for money that you already put in. But if you put in new

considerations that you could demand as a condition to be collateral.

Simon: What we should have done, or what we maybe we still should do to protect our original group of investors, is to have them pony up a few more thousand or whatever you think is legitimate, and amend the contracts to protect them as well.

Utley: That's new subject matter.

Simon: Well, I only brought it up because it had to do with the patents.

Utley: I know but can we finish the patent discussions before we bring up new subject matter.

Simon: You can, but I want to make sure that we do finish.

Utley: No, I agree with you Si.

Si: The problem is that I made claims to certain people like Don Kane, who put up \$100,000, who thinks...

Bernstein: Let's get back to that. No, let's get back to it. It's a definite point. There are people.

Buchsbaum: This is a business issue for later.

Bernstein: No, we're asked by these very people these questions.

Boehm: Did you get your question answered on the...

Buchsbaum: Yeah, I just wanted to understand...you know, I got an answer. It had to do with the obligations Si I was trying to understand if somebody does due diligence now with regards to understanding what is there and what has to be done, like those yellow tabs. [Yellow tabs indicate signatures of missing inventors]

Boehm: Yeah, but after...I find everybody, we can get guys to sign.

Buchsbaum: We aren't that many. I don't know on that sheet what you have, but I don't think there are that many names. There's what about five names?

Buchsbaum: There aren't that many...you don't have that many. I don't know on that sheet you have, I don't think there's that many names.

Boehm: No, there's not.

Boehm: So we have everybody but Jeff, if we can get Jude and Zak.

Buchsbaum: You just have to get people around and sign.

Boehm: No, that should not be and issue.

Buchsbaum: That might be questions brought up when people do do due diligence. Is everybody else on these?

Bernstein: That's why we're closing it. Right?

Boehm: We'll record what was in the patent office(...???) can do.

Utley: The other piece that's not in any part of the original filings, which is the reduction of the technology to a disciplined process—the mathematical representations of what's in and how it works and stuff like that.

Wheeler: (...???)

Buchsbaum: That will also be included in there, right?

Utley: We'll put it in the new filing...one of the new filings.

Wheeler: I form my opinion of everything, and we can talk about post solutions but I think Brian wants to get this back on track, but to me there's bad news and there's good news in this. The bad news is, just like anything in life, perhaps we would have liked to have tidied up some things better, like to have had Mr. Joao tidy them up. The good news is considering the state that the corporation was in in the early stages and the variable limited resources that it had, I'm glad that we have an awful lot on record that we do have on record, to be honest with you.

Simon: As long as it's not to the detriment of what we thought we were filing, I have no...I couldn't agree with you more.

Wheeler: But I think I like your approach, and I assume it's your approach, too, in that I assume that you're doing a fairly comprehensive new one, but then you're going to probably...

Utley: Claim priority back to the old one.

Wheeler: Right, but you're also going to do your amendment because now we're finding out that it's not an uncommon procedure and it's not a red flag.

Utley: Two things: the new filing on Wednesday will claim priority all the way back for as much as possible back to March 24th last year. Second, we will look at the March 24th year 2000 filing and determine how we should amend that to include additional claims and broaden that filing so that it more fully represents the knowledge of the invention as of that time.

Bernstein: Does it claim all the way back?

Wheeler: It'll go all the way back...

Boehm: as long as you don't go outside what was described.

Bernstein: No, the math is just describing the original invention.

Boehm: We'll, I'll never know the answer to that until it's litigated.

Utley: Due diligence.

Bernstein: Right, but from your perspective here, that's what we're setting up. Correct?

Boehm: We're going to try.

Bernstein: Okay.

Boehm: The question never even gets answered half the time in the real world. I will claim priority back on the document, and then if the examiner doesn't care, nobody cares

Bernstein: It gets through.

Boehm: It gets through.

Wheeler: Would it be a fair assessment—I'm posing this more as a novice, not as an attorney here—since we're not at IBM and we don't sit down at the very beginning and work out all these equations and all that, that in an invention such as this by a Ma-and-Pa type of inventor, and now since we're getting into the nuts and bolts and really uncovering, in essence, what's behind it, as Brian dissected it as we moved along, but that's all we're doing? I mean, that Ma-and-Pa inventors do that as they go along? They add the flesh to the bones as they go along?

Boehm: Boy, that happens, and we try not...we try to minimize the amount because if the flesh that you have to add is new subject matter and you've already sold your invention a year ago, you're dead.

Wheeler: Well no, Let me at it a different way. It does this, but I can't describe how it does this. But now we find out...we tell you what it does, now we're telling you in detail how it does it.

Boehm: Yeah, in terms of we claimed it properly.

Wheeler: So I'm not adding flesh in defense...

Simon: New flesh.

Wheeler: ...new flesh. I've got the box, now I'm disclosing what's in the box including the gears and how it works.

Bernstein: No.

Utley: No. Here's what the big difference is. The original filing claims a process for print film imaging.

Bernstein: Well, that was all stricken, by the way. That's why I'm having a big problem. I was going to get to that next, Brian.

Utley: Okay, good.

Bernstein: But we have discussed with Ray Joao numerous times to take out the references to print images out of this right here. Over the course of the year in the 59,000 modifications back and forth, we continuously pushed him away from the words that I see in this filing, and that's what's so disturbing to me because we sat here when...

<End Side 1; begin Side 2>

Buchsbaum: That would be conditional, probably.

Simon: Right, they probably will.

Wheeler: Their not going to want in fact their going to say take it off aren't they

Utley: No Crossbow notes would be converted to equity when someone else comes in.

Si? Of course, and that's gone. And those issues are gone.

Wheeler: Well, Yeah, so that it was the ...it was intelligent way to do it...and I'm not...

Buchsbaum: Crossbow would probably manage the million dollars anyway

Wheeler: By the way, if we did do a deal by which we tried to collateralize it even further, then we'd have to have some sort of provisions as well to get rid of your collateral.

Simon: Yes, of course. As soon as it converts to equity, it's gone.

Wheeler: But I mean, what if you didn't convert yours to equity[]?

Simon: Then you'd have to lose it anyway.

Wheeler: But at a point.

Utley: It just becomes a normal stockholder...

Simon: Right.

Wheeler: It would have to drop away or something. For instance, it would drop away when theirs drops away.

Utley: The stockholders, in the event of a default, the stockholders, the distribution that takes place, includes all the stockholders according to the rank of the preference. So the preferred get first cut, and the common stockholders get the second cut, whatever is left for

distribution. But of that amount[] unless there's nothing to distribute.

Simon: Not if one of the preferred stockholders has a collateralized position and the others don't. If one of these preferred stockholders...

Utley: There's no stockholders that have a collateralized position.

Simon: That's true.

Buchsbaum: You're talking about the small amount of money, that have any value, it should be reasonable value, and those would be taken out anyway.

Simon: Except that we seem to feel that we have an obligation to those, to protect the other stockholders who...had all good...I think its prudent anybody to ask permission

Buchsbaum: A good way to do it is the way he said to do it, and that's to [?].

Utley: Will you look it up and see what it's going to take to do it?

Wheeler: I'll coordinate that

Utley: I'm not clear. What are we trying to do? Are we trying to provide for collateral for new money coming in, or are we trying to...? We're not trying to collateralize money which has already been...

Simon: I don't know. Can you handle the old money the same way? I don't think so.

Wheeler: We have to see. We might be able to consider it for the full amount in the view of the fact that if you had enough substantial new consideration, ...

Buchsbaum: The problem is that you may have to go back to Crossbow to do that, and you may be better off just to do it on subsequent money.

Simon: Well, but to ask Don Kane to put up \$10,000 when he's got \$160,000 in the...\$135,000 in the company, and then he only gets 10%...\$10,000 worth of consideration...I'd like to protect his whole \$165,000, which is what he has.

Buchsbaum: The answer is you go back and ...

Utley: I don't think you can do that because that's equity. It's in common stock.

Bernstein: It's not equity. It's a loan.

Bernstein: Don had the stock prior to his putting up the money. These are loans. There's \$400,000 that's on the books. Then there's another \$100,000 besides what he put in originally. Sal has a loan on the books of \$25,000. Your guy should have had a loan on the books for \$250,000.

Utley: No, that's equity. Okay.

Simon: At any rate, <tape cuts out[tape does not cut out on my tape]>...While I got Chris here I'm going to take advantage of his being here.

Simon: One of the issues we tried to do when we raised the last \$80,000 that came from Eliot's two friends Anderson and Mitch Welsch. []

Bernstein: Ken Anderson.

Simon: It was my knowledge, according to Jerry, that those monies were to go to Eliot, and then Eliot was theoretically to loan the money to the company so that Eliot would have a loan on the books and he would have sold his stock because Eliot has some personal needs that he needs to accomplish as soon as we get funded or we get some money in here. I'm under the understanding again. It could be way off.

Bernstein: How do we work that out, Brian? The 10? A loan?

Utley: Yeah, that's better because otherwise you will get taxed.

Bernstein: Will they loan me \$10,000 to pay the taxes?

Simon: Who loaned you?

Bernstein: The company just today?

Utley: So I took that as a loan?

Utley: Yes.

Bernstein: The money went to the company, which spent the money already—the stock money—from Ken and Mitch.

Simon: You haven't sold any of your stock?

Bernstein: No.

Simon: You just made an officer's loan.

Wheeler: Right.

Simon: Is that how you handle it?

Simon: You loan the loan back by some method at some point.

Bernstein: Right. Correct.

Buchsbaum: That's the way to do that?

Utley: Well, there's no tax impact...

Simon: but he would have had a [] gain.

Bernstein: Right. And there were other things at the time...right, things. At the time, the company needed the money and I didn't...not that I didn't

Simon: Sure, I just wanted to make sure that it was done. I didn't even know ...???that bank account

Bernstein: Not that I didn't.

Simon: Let's finish up.

Utley: Eliot, let me summarize. I want to make sure we have an agreement of this meeting. Let me interject two final two points that we kind of skimmed over. One is you said that we want to go ahead and change the claims to go all the way back on this US, but we have sort of got covered on the one we're filing? The one we're filing is a PCT. It won't pop to the US for 18 or 30 months. Or we could file another PCT and a US, then the claims would hit the US. In other words what I'm saying is it would matter if we do the claims here. We could either fix up the claims here or file a PCT and a parallel US if you want US patent protection sooner. The PCT will split out to US, but not until later. You can file a US anytime...

Simon: Let me ask you. You're not a lawyer, what do you recommend?

Boehm: Well, it's more money up front.

Simon: How much money? A great sum of money?

Boehm: No, it's another grand to file.

Simon: For what we've spent already, let's do it.

Bernstein: And that protects us better?

Boehm: Quicker. You'll get a quicker US patent. It'll get you in line quicker.

Utley: The other point that you're making because in this week's filing we are going to claim all the way back...

Boehm: We're going to claim all the way back but this is what is supported

Utley: Right. So if we claim all the way back to March of last year, do we need to touch the filing that's already in motion?

Boehm: The one that's out there?

Utley: Yes the PCT. Do we need to touch that?

Boehm: No, no. There's a PCT and a US.

Utley: Right.

Boehm: The PCT, we will get a search back. In fact, we should get it in a month or so, and then you'll decide what you want to do with that, what foreign country and possibly the US, but he files the same thing basically in the US, and now it's in line in the US.

Utley: Right, right. But what I'm saying is if the new filing that we make this week creates priority all the way back and embraces all of the teachings of the prior...

Boehm: Zoom and pan stuff.

Utley: Zoom and pan stuff, filings, do we need to go and modify and update and amend those earlier filings?

Boehm: Those other two.

Buchsbaum: That's a good question would there be new recommendation?

Boehm: It depends on two things. One is how quickly do you want to get the US for the new filing? This is a PCT that we're preparing right now. If we file the US right away with it, then it makes less difference.

Bernstein: Less?

Boehm: Less difference because he's in line sooner. That's all. It just depends on how soon you want to get your patent.

Bernstein: Well, we want to go for the sooner.

Utley: The sooner the better.

Boehm: The sooner the better then let me play with this

Bernstein: Right.

Boehm: Plus you're gonna get an office action back from the patent office on him...

Bernstein: On that.

Boehm: For free. There's nothing involved.

Bernstein: Right, but it doesn't claim anything.

Boehm: I don't know yet. It claims...he'll get this blasted. It will will be rejected.

Bernstein: Yeah.

Boehm: It will be rejected. The question is do we want to fix this, or where are we with the other things? So there's no decisions to be made now on this, it's just that do you want to file a US and a PCT?

Utley: The answers yes

Boehm Yes

Bernstein: And we do want to fix the original work?

Boehm: We can decide that later.

Bernstein: Well, why would we leave it unfixed?

Boehm: Because you can't get two patents on the same thing. So if we fix this, you're not going to get it over here.

Bernstein: But then we lose the date.

Buchsbaum: No we don't.

Simon: That's what he's saying.

Buchsbaum: You really don't lose the date.

Wheeler: So were not going to...???

Utley: Because he's claiming all the way back.

Boehm: We may not. It depends on...

Bernstein: May and less, these are words that scare me.

Boehm: You don't like that, do you?

Bernstein: No, I do not.

Boehm: But I don't think this is the right time to make that decision now.

Utley: What is the right time?

Boehm: When we get some office action back on this patent. And when we hear from the patent office, we'll sit down say do we want to fix this, or do we want to fix this, or have we uncovered some killer Prior Art that blows this whole thing out of the water? You don't want to spend money right now if you can avoid it.

Wheeler: We've never done a search, have we?

Boehm: We did a search...I've done a search on...<Everyone talking at once.> on a dozen patents that really weren't on point. We didn't find any close Prior Art; and all I can tell these...

Wheeler: This was on imaging and video?

Boehm: Yeah.

Wheeler: That's incredible.

Buchsbaum: Yeah, it was huge.

Bernstein: If it is found impossible to do these things, why would people be doing them?

Boehm: I want to make...the tape recorders off, right? <Recorder turned off>

Buchsbaum: What does PCT mean?

Boehm: Patent Cooperation Treaty. It's a formal filing process for filing foreign patents.

Buchsbaum: Oh, that's the thing with the different countries?

Boehm: Yeah. So we file one application that splits out later to different countries.

Buchsbaum: Two years?

Boehm: Yes, but we'll get indicators before that. Our search comes in nine months, which is three months from now for the first one. But, Brian, they're searching this claim; this claim is crap. You're not going to get a good search on it.

Buchsbaum: So what? In six months or nine months, we'll start hearing from them?

Boehm: Yeah.

Bernstein: Well then we should do an alternate search on what you have.

Boehm: It's a judgment call. I mean, you asked me this question a while ago, and you said what would it take to get me comfortable because I'm kind of a pessimist and I'm an engineer, so I have that background where I look at it that it's half empty. It would take more searching, and it would take more searching inside the technical articles. And it would take quite a bit of work. I mean, I guess \$5,000, I don't know. It depends on what happens. Then, again, that will only raise you to a different level of comfort, that's all.

Bernstein: And then they'll say the same thing, and for another five grand, well get Rays to another indiscriminate level of comfort.

Boehm: Exactly. But we don't have to do that because we will be getting an article...

Bernstein: Right, from the searches.

Boehm: And from your investors because if I was working for them...

Buchsbaum: Let me put it another way. If you have somebody that will take this company and auction off the technology, okay? As it is existing...as it is unfolding, okay? And as the licenses come along. It's strategy. Some of these people bid on that. What are they really bidding on? It's potentials, right? Basically?

Boehm: Well, no, there's a present value of the technology. If you...

Buchsbaum: Well, not if you don't have patents issued on it.

Boehm: Well, sure there is. Sure there is. If he can get a royalty based on 2% of their products—or whatever it is—per minute, whether or not it is patented, absolutely.

Buchsbaum: My question is at what point does it become...is the efficacy there significantly enough from the standpoint of others now that would be doing their own review. You know, like, say a firm that would do the option. They'd have their patent lawyers take a look at what you're doing to see if they think it has a real good value. At what point does that come along? Is it six or nine months from now, basically? Is that when that probably would start to unfold as far as having a real relevant potential value? I've been trying to get a general..

Boehm: I understand your question. I guess I would answer...

Buchsbaum: General idea.

Boehm: If your licensees are spending a lot of money...

Buchsbaum: On your technology.

Boehm: On your technology, they're going to have their patent attorneys right now, today, go do a search, and they will have a good indication. They may come up with Prior Art that blows you out of the water. They may find nothing. They may not search it. They may say, we don't care about patents; it's the technology.

Buchsbaum: Reality, though, this is not the...more likely six to nine months as some licenses start to unfold here and as things start to come back, and that's when this thing will start to have some relevance more than it does right now? From the standpoint of the...

Boehm: That the patent will have relevance?

Buchsbaum: No, no. The technology has a value that can be created in the marketplace and turned to bidding.

Wheeler: Well, you can look at the technology as almost value added to the company. I mean, the company has worth because of the process and what we can provide and we can build it up. But it'll even astronomical more worth assuming that we have...that it's totally proprietary to ourselves. Now some companies have great technology that's proprietary to themselves, and it doesn't earn them money. For instance, Wang Laboratories went down the tubes. They had the best word processing, and they had the best of everything else. And, of course, a lot of their technology is licensed out there, as I understand it, to VisionAire and to...they did the true ones, and...

Buchsbaum: It's was also to get to the possible strategy for the company's investors, okay?

Utley: Right.

Buchsbaum: Or it may be at some point a window of huge value placed on this technology where you may take advantage of it.

Wheeler: Well, and to our investors, we have said, and we can continue to say, we are attempting to create a pool of intellectual property and protect it.

Buchsbaum: Okay.

Wheeler: But there can be no assurances that this will withstand the test of time.

Boehm: That is exactly it. And you never want even when it issues. You will get a good comfort level when you have a US patent issued in your hands.

Bernstein: Why?

Boehm: Because you've had an examination.

Buchsbaum: Because you've got some review.

Boehm: Because you have a presumption of validity.

Bernstein: That's why I'd like to get that first one corrected because that's the first one that's going to be examined.

Boehm: No, we've got one...oh, yeah, it is. It's the US.

Bernstein: And therefore I want that to be approved. The investors are going to say...

Buchsbaum: The first one that we're going to be issued will be issued in May.

Bernstein: And the investors are going to say what happened to patent one.

Boehm: 3/10 of 2000 was when it was filed. Typically a year...they'll get around to it within a year. Maybe it'll issue in. 18 months to two years

Buchsbaum: From right now or from then?

Boehm: From 3/10.

Bernstein: What is the process speed up? If you can show...

Boehm: If you can show somebody's infringing, you can have an expedited examination; but that doesn't always buy you much time, and you really have to get into the patent office the first time, and I'm not sure we can do that.

Wheeler: Wouldn't a good example of one way be that Apple had really great patents, and Microsoft was still able to come in and duplicate it, even though everyone knows they violated the hell out of the patent of Apple.

Boehm: Um, hum.

Wheeler: So I mean you could have a good patent and it could still go down the tubes. But another one I'm thinking of that did stand up was Polaroid had patents and Kodak tried to come in and do everything to distinguish, and wasn't able to and got clobbered, right? And there's probably a lot of every variation in between.

Boehm: Yeah. Wheeler: [Not in transcript this is strange here]

Wheeler: Are those the two extremes?

Boehm: Yeah,

Wheeler: those would be the two extremes.

Utley: Especially when it comes to method patents and software patents.

Wheeler: Yeah, what was the first thing that Brian

Boehm: ...and the more patents you have, the less chances. It's like putting out mine fields...less chances people to get around you. But if the original concept is broad enough and claimed right, Yeah, we can be okay.

Boehm: But what, the test - I guess what you're asking for is when we have that first claim promised, probably within two years of when you filed, which is March 10, 2000, I would probably say

Utley Doug come back, close it out again.
<Inaudible comment.>

Boehm: There were two points. One was the PCT and I got that in correct.

Buchsbaum: Right.

Boehm: The second point was everybody was saying you don't destroy documents. Lawyers do destroy documents; and in the patent realm, it is common practice to get rid of all of our attorney notes, but it depends on what the practice is in your law firm and your corporation. Most patent attorneys who use this practice that I've seen, it happens after it issues. You never do it before. I don't even like to do it then. I like to do it after all the...

Bernstein: I don't even understand why you're destroying it. If you've got nothing to hide and everything's on the up-and-up.

Boehm: But throw in the concept that I'm leaving the law firm. Let's say I'm leaving the law firm, my notes, who's going to follow up and destroy my notes to benefit you, because I do want them six months from now. Maybe that's what he's doing.

Wheeler: Yeah, he could have done it to protect you. He didn't want them around in the other office.

Bernstein: I don't know. I don't know. I don't even know if he knew he was leaving then.

Boehm: Now it's intentional!

Utley: But I want to comeback were going to file PCT and US on the new one. We're going to wait for the old one to get kicked back; and when it gets kicked back by the examiners, we'll then determine how we want to amend it. Is that what you said?

Boehm: No, I want to say something on that again. I think if you want a patent to pop quickly—if that's the goal, which sounds like it's a good goal—then, no, I think we should amend the claims with a preliminary amendment before the examination.

Utley: A preliminary amendment?

Boehm: A preliminary amendment.

Bernstein: Encompassing everything we can throw in there?

Boehm: Yeah, whatever support there is. But a preliminary amendment on whatever it is on the...

Bernstein: So we're going back to the original

Boehm: So I'll fix the 119 case yeah

Bernstein: March 3, 2000, to encompass what we've embraced.

Utley: When will you be in a position to recommend what that amendment will look like?

Bernstein: It should look a lot like the one we just did.

Boehm: Yeah, that's...

Bernstein: That's my guess.

Utley: When will you be in a position to...

Boehm: I'd have to...a few days...

Utley: About a week or so?

Boehm: Oh, Yeah, within a week, sure.

Bernstein: Okay. That's good.

<End of meeting.>



EXHIBIT I



**HAND NOTES OF MR. JOAO IN FILIPECK MEETING AT RESPONDENT S
OFFICE**

Proskauer 21st Floor

Steve Filipeck - Fish + Richardson

9/20/99

32mm → Wide angle lenses

image cameras

take out all specific software & hardware

magnification vs zooming

* Scan directly from the film w/ enlarger

JPEG file is always compressed

difference is that

if lowest compression is introduced virtually no

artifacts - as compression - you narrow

color compression - lose definition

* put in more detail on how the process works

#7 Video - straight through live connection to camera through capture device & onto the web

** When you take/process a live capture or capture from a remote medium & process it, you may take it or the processed & prepared form on a computer storage medium which is streamable, process & stored in deliverable form.

** Computer stores the processed videos & stores it.

EV-26

1/11/00

Conf / B. Utley - Wheeler

p.1

↳ Processes defined at site level
 based on tools - everything we use is
 public domain
 parameters are of such a nature - little
 if any + claim as patentable.

↳ Breached Confidentiality Agreement
 ↳ several steps had to go through to arrive at
 side rider b/c integrated into Dazzy card
 & Real player.

↳

1st patents pending have value

Bit 4
20.5
2026

2nd. Head of K - complexity
 • Misapprop of trade secrets
 • establish a solid base of
 original claims.

show when where + how process
created

↳ process currently being employed in
 public domain already
 Capture + encode
 • Qui • evade



-2

1/26/00 Conference with Brian Utley re copying of records.
Copies ~~will~~ will be forwarded to Brian today or
tomorrow. Spoke also future patents activities and
prospect of finding a strategic money partner (i.e.
Sony Pictures).

For IViewIT

Priskans

→ Needs description of each application

Gayle Coleman

561-995-4749

Fax 561-241-7145

email G Coleman@Priskans.com

- APPLICATE
- TITLE
- Serial No.

~~8:30~~

→ 4 @ 1 2
copy [unclear] 2 0/



SCHEDULING OF THE FILIPECK MEETING

PROSKAUER ROSE LLP

2255 Glades Road
Suite 340 West
Boca Raton, FL 33431-7360
Telephone 561.241.7400
Elsewhere in Florida
800.432.7746
Fax 561.241.7145

NEW YORK
LOS ANGELES
WASHINGTON
NEWARK
PARIS

Form with fields: Date (September 17, 1999), Client-Matter (0894/40017/001), Total Pages (including Cover), From (Gloria, for Christopher C. Wheeler), Sender's Voice Number (561.995.4702), To (Brian G. Utley), Company, Sender's Room Number, Main Fax Operator (561.241.7400), Fax No. (393.7458), Voice No. (750.6876)

Message

The two closest hotels with our special Proskauer rates are:

Renaissance Hotel (1/2 block from Proskauer offices)
714 Seventh Avenue
New York, NY 10036
212.765.7676 212.261.5151 (Fax)
Ask for Proskauer Rate

DoubleTree Guest Suites
1568 Broadway
New York, NY 10036
212.719.1600 212.345.5237 (Fax)
Ask for Proskauer Rate

Handwritten note: Conf # 837.137.11, 800 468 3571

The following Proskauer conference room details have been completed:

Conference Room 2100 (also called the Goetz Room);
21st Floor of our building located at 1585 Broadway;
Large room that holds 20;
Reserved for 8 AM until 10 AM, Tuesday, September 21, 1999;
A receptionist is right outside the conference room and she can help answer any questions,
the receptionist arrives at 8:30 AM;
Coffee, tea and ice water will be set up in the conference room at 7:30 AM;
The glass doors to the Proskauer office on the 21st floor are locked until 8:30. After you exit the
elevator, use the phone by the glass doors to call security to let you in.

Confidentiality Note: This message is confidential and intended only for the use of the addressee(s) named above. It may contain legally privileged material. Dissemination, distribution or copying of this message, other than by such addressee(s), is strictly prohibited. If you have received this message in error, please immediately notify us by telephone and return the original to us at the address above. We will reimburse you for the cost of the telephone call and postage. Thank you.

0894/40017-001 BRLIB1/241812 v1

09/17/99 04:49 PM (2743)



HAND NOTES OF MR. WHEELER IN FILIPECK MEETING AT RESPONDENT S OFFICE

Notes
Meeting of Providence in NY

Ray + Bryan met at Tilipich -
copy of non-disclosure coming

Document 4.1
+ Document 1

5 + 6 are extensions -

Steve - "my concerns, issues" - very
uncomfortable with what I have read -

Bryan leaves

Ray says walked to train + no issues

Bryan calls Chris H. -

"inquiry OK"

"on video side - could not give
response to video question"

"did not feel comfortable with video -
- couldn't explain how it worked -
Steve taken aback by question -
they asked - "what is your view about
quality of video + how it works"
didn't get into how it works -

that is important and needs to be covered -

video involving - only recently -> document 7 is
not filed -> very important that we complete -

Wids

- old account didn't address -
- no attacks -
- they have investment in video - the new
- the same - we had it -

raise level of debate & motivation -

~~this is~~

high demand →

not as easy to explain how it works -

Video → more subject to attack

Ours is not related to compression techniques -

If inquiry case we return to 1st step -
→ we do not do that with video -

- Video side is more opaque -

Royalty free →



LETTER OF MR. COLTER RELYING ON RESPONDENT S OPINION

Subj:iviewit

Date:1/14/2002 9:51:08 PM Pacific Standard Time

From:David.Colter@warnerbros.com (DColter0264)

To:John.calkins@warnerbros.com

CC:CHuck.dages@warnerbros.com, Alan.Bell@warnerbros.com (ABell0648)

Sent on: AOL 6.0 for Windows US sub 10551

John,

In all the review we have done with iviewit it seems to boil down to the status of the patents and their inherent value. At that point it is a risk-reward evaluation -- without awarded patents it is difficult to completely assess the value. I would suggest that we consider one other perspective...

Prior to iviewit (approx Feb 2000) the video we (WB Online) delivered on the web was QCIF (160x120) or smaller and was below full frame rate. At the time of our first meeting we also identified On2 along with iviewit as two solid players who could deliver full screen full frame rate web video. All who saw it were impressed. Greg and I visited iviewit in August and reported back that they had filed patents on scaling techniques that hinged upon a visual 'trick' which allowed the human eye to accept 320x240 video scaled to 640x480 at 30 fps as close to VHS quality. We checked with Ken Rubenstein and others who provided some solid support for iviewit, and Chris Cookson asked Greg and I to continue to work with iviewit in an R&D capacity.

In the fall of 2000 iviewit also met with a number of folks at WB Online (in September and October) and demonstrated their process and techniques to Sam Smith, Houston, Joe Annino and others. Sam contacted iviewit a number of times and requested the patents, along with specifics of the iviewit process to evaluate what they were doing. I was not part of these meetings, but was aware they had occurred, as Jack Scanlon kept me up to date.

When I sat down with Morgan and Houston in March 2001 to see what technology they were using to encode video, it was clear that they were using some of the techniques that would overlap with iviewit's filed process patents (still pending), but it is not clear that these were all learned from iviewit -- we may wish to explore this a little. This meeting was to determine what equipment we would get for our lab at 611 Brand. This same information was also provided to iviewit by Morgan as they were establishing the company as an outsourcing facility for encoding our content.

I am aware of several meetings held between iviewit and WB Online to share information of techniques and process, and was invited to a few of them.

We all signed iviewit's confidentiality agreement. So to the other perspective....

We have an opportunity to establish a license with iviewit for a modest fee at this time, and establish a MFN. In good faith we signed the confidentiality agreement, iviewit revealed their processes and techniques, and we now use those techniques in encoding. As we have discussed on a few occasions, these techniques now appear in the public domain to some extent in documentation for Real Producer, WMP Developer Guides, Media Cleaner Pro, etc, but they were not available in 2000. I would not suggest we learned the techniques completely from iviewit (I actually do not know the answer), but a modest licensing fee may be appropriate and honorable considering our good faith relationship in signing the confidentiality doc.

If we choose to pass at this time the risk is primarily from iviewit's main investor, Crossbow Ventures, gaining control of the IP and approaching WB later for a license -- I do not believe they will be as friendly considering their dealings with iviewit and it's employees since Feb of 2001. It is estimated that the patents will be completed in 8-12 months.



As you are all aware I have a personal relationship with Eliot Bernstein, the founder of iVIEWIT, and as a result, I left the evaluations and decisions to Greg, and others, and only assisted iVIEWIT to get to the correct people in WB and AOLTW. I wanted to add this perspective as we consider if there is an option to pursue with iVIEWIT -- they are facing continued financial pressure right now. There are many other threads to our interaction with iVIEWIT and I would be happy to discuss.

Thanx,
David



LETTER OF MR. WHEELER APPEALING TO PARTNERS

Dear Colleagues,

As a firm, we are in a unique position to impact the effectiveness of the Internet and to profit from the same. The firm of iviewit.com, Inc. is one of my clients and Proskauer, Rose, LLP. is a 2.5% shareholder. I have worked closely with iviewit, for the past 18 months, establishing and fine-tuning their corporate structure. My objective with this letter is to introduce you to this forward-thinking company and to ask for your support and assistance.

The Internet is quickly evolving from a text-based medium that users have been forced to read, into a multimedia platform that users can begin to *experience*. The importance that this evolution has to e-commerce has been likened to the impact felt by television when it was embraced as a marketing and communications tool. iviewit's intellectual property positions them as a leader in the streaming video, streaming audio and virtual imaging online markets. Their technologies have broad ranging applications for many different industries including: entertainment, auctions, education, healthcare and retail.

Because of the extensive applicability of iviewit's products, the vast majority of Proskauer's client relationships represent potential clients for iviewit. Please join me as I endeavor to introduce my clients to iviewit and, in the process, help those clients to gain a competitive advantage through the utilization of iviewit's technologies. Please contact me with any opportunities that you identify and I will arrange an introduction to a member of iviewit's management team. I have enclosed a descriptive flyer from iviewit and a multimedia CD-ROM that will serve as an introduction to iviewit. Additional information can be found at their website, www.iviewit.com.

Thank you for your time and attention. I look forward to working together to help this valued client and to further enhance the value of our equity position in iviewit.

Sincerely,

Christopher C. Wheeler



EXHIBIT J



**DEPOSITION OF RESPONDENT IN THAT CERTAIN LITIGATION
AVOIDING QUESTION ON MPEG LA, LLC**

2 Q. How about what is called the MPEG
3 Patent Pool, have you heard of that?

4 A. Yes, I have.

5 Q. why don't you tell me what that
6 is.

7 A. Decline to answer at this time.

8 Q. why do you decline to answer?

9 A. Irrelevant to this deposition.

10 Q. I'm sorry, irrelevancy is not an
11 objection that would allow you not to answer,
12 sir.

13 A. Make a motion to the judge. If he
14 orders me to tell you about it, I will tell
15 you.

16 MR. SELZ: Chris, are you
17 instructing your client not to answer?

18 MR. PRUSASKI: I am going to put
19 an question for relevancy based on the
20 court's granting of the motion and
21 limiting on the record, and if
22 Mr. Rubenstein declines to answer then
23 he is declining to answer.

24 And, just so I don't have to keep
25 objecting, Mr. Selz, to make this

13

1 Rubenstein
2 easier, my objection is continuing in
3 nature as to any questions regarding any
Page 11



4 transactions for IViewIt that you are
5 going to ask Mr. Rubenstein if he was
6 involved in based on the court's
7 granting of the motion and limiting.

8 MR. SELZ: Let me go on the record
9 and say the discovery documents that
10 have been produced by the Defendants --
11 Plaintiff in this matter indicate
12 various dealings in which Proskauer Rose
13 was affiliated including dealings with
14 H. Wayne Huizenga, CrossBow Ventures,
15 wachovia, a number of other entities
16 which are part of the discovery and have
17 been produced by the Plaintiffs pursuant
18 to a valid request for production, so to
19 the extent you are claiming it's subject
20 to any motion and limited, that's fine
21 with regard to the trial, and the
22 discovery you produced on your own
23 pursuant to a request for production
24 which has not been held invalid includes
25 these very matters.

14

1 Rubenstein

2 A. So why don't you tell me more
3 particularly what you want to know.

4 MR. PRUSASKI: Mr. Selz, let me
5 just respond to that.

6 There were never any affirmative
Page 12



7 defenses asserted by the Defendants in
8 this matter that have anything to do
9 with particular transactions, the
10 defenses involved whether the bills
11 were --

12 MR. SELZ: Let's go --

13 MR. PRUSASKI: I get to finish
14 because --

15 MR. SELZ: Go ahead and finish.

16 MR. PRUSASKI: Thank you.

17 There were never any affirmative
18 defenses asserted by the Defendants in
19 this matter relating to anything other
20 than the amount of the bills. And, so,
21 to the extent that the court granted our
22 motion limiting it, the Defendants can't
23 put any evidence of any particular
24 transactions or alleged wrongdoing by
25 Proskauer on at trial, but to that

15

1 Rubenstein
2 extent I am going to ask Mr. Rubenstein
3 to answer your questions. If I feel
4 that they are becoming overreaching, I
5 will make -- or if you are extending too
6 far into what I think is a violation of
7 the court's granting of the motion of
8 limiting, I will make another objection.

9 MR. SELZ: And let me go on the
Page 13



10 record, the motion of limiting is fine
11 with regard to anything presented at
12 trial. It certainly does not preclude
13 the scope of discovery from including,
14 in a deposition, questions which may
15 lead to discoverable evidence concerning
16 the bills and the services that were
17 provided, which is the basis for the
18 affirmative defenses.

19 MR. PRUSASKI: And I am aware that
20 you have some latitude with respect to
21 discovery under the rules.

22 MR. SELZ: And I think we have
23 pretty significant latitude under the
24 rules.

25 And with regard to your client,

]

16

1 Rubenstein
2 Mr. Rubenstein, indicating he is
3 refusing to answer, I believe you should
4 instruct him right now, under Florida
5 law, he doesn't have the right to refuse
6 to answer.

7 A. All right, I will answer the
8 question.

9 MR. PRUSASKI: I just said a
10 minute ago we will go ahead.

11 A. Anything you want to know about
12 the MPEGLA patent pool, that's public

Page 14



13 information, it's is on a web site,
14 MPEGLA.com. You should go look at that
15 web site. Any public information that I am
16 entitled to tell you is on that web site.
17 Q. well, I am going to ask you, sir,
18 in this deposition to give me that
19 information.
20 A. And I am just telling you to go
21 look at the web site.
22 MR. SELZ: Let the record show the
23 witness is refusing to respond to a
24 direct question.
25 A. That is an incorrect

17

1 Rubenstein
2 characterization of the record.
3 The record shows that I told you a
4 place where you can get the answer very
5 easily. There is no reason for you to make me
6 sit here and waste my time repeating to you
7 things you can easily read about.
8 Q. well, sir, this is your testimony
9 at your deposition.
10 A. That's right, which you are making
11 me do. I consider the deposition nothing but
12 harassment, considering that I had nothing to
13 do with the company. It's just a form of
14 harassment.
15 You go read the web site, if you
Page 15



16 want to know about it.

17 Q. Okay, so you are refusing to
18 answer?

19 A. I am not refusing.

20 Q. Other than advising me to go to a
21 web site --

22 A. I am not refusing to answer. I
23 did answer. Please stop characterizing my
24 testimony. I told you the answer. I told you
25 all publicly-available information about the

18

1 Rubenstein
2 MPEG patent pool can be found at
3 www.MPEGLA.com. You are free to go read it.
4 Please go read it and you will learn all you
5 need to know about it.

6 Q. So you are not going to tell me
7 what the "MPEG patent pool" is?

8 A. I told you you could go read it.

9 Q. Okay.

10 MR. SELZ: Chris, do you want to
11 instruct your witness, or deponent, or
12 client, at all in that matter?

13 MR. PRUSASKI: Do you have any
14 specific questions with respect to
15 IViewIt in the MPEG patent pool?

16 MR. SELZ: Yes.

17 A. All right, so why don't you ask me
18 those questions.

Page 16



19 MR. SELZ: I want Mr. Rubenstein
20 to first explain to me what the "MPEG
21 patent pool" is, and then I will ask him
22 questions concerning exactly how it
23 relates to IViewIt.

24 In other words --

25 A. Okay, I will answer both your

19

1 Rubenstein

2 questions.

3 Q. Go ahead.

4 A. The "MPEG patent pool" is a
5 collection of patents owned by a group of
6 companies related to the MPEG 2 video
7 compression standard and, as far as I know, it
8 has nothing whatsoever to do with IViewIt.

9 Q. So it has no technology -- the
10 MPEG patent pool uses no technology in any way
11 related to any of the IViewIt entities or
12 their intellectual properties; is that your
13 testimony?

14 A. No, it's not my testimony.

15 Q. Okay.

16 A. My testimony is, it's a group of
17 patents chosen according to very specific
18 criteria related to the MPEG 2 standard and,
19 to my knowledge, has nothing to do with
20 IViewIt.

21 And please do not characterize my
Page 17



22 words. Please do not rephrase them. If you
23 don't know what I said, you can ask the
24 reporter to read it back. But do not
25 characterize my testimony.

20

1 Rubenstein

2 MR. SELZ: Again, let the record
3 reflect the deponent is not being
4 responsive.

5 A. I am being very responsive.
6 Please stop characterizing my testimony. And
7 please stop putting things on the record that
8 are incorrect.

9 Q. Mr. Rubenstein, I am asking you
10 questions, and I am asking --

11 A. And you are not listening to the
12 answers very carefully, so -- I don't know how
13 much experience you have taking depositions --

14 MR. SELZ: Again, let the record
15 reflect that --

16 A. Stop interrupting my answers. Do
17 not interrupt me.

18 Q. Mr. --

19 A. Do not interrupt me.

20 Q. Mr. Rubenstein --

21 A. Let me finish.

22 Are you going to proceed to
23 continue to interrupt me or not?

24 Q. If you want to answer the
Page 18



25 questions, I have no problem.

21

1 Rubenstein

2 A. Look, I answered your questions.
3 You are unable to keep track of what I am
4 saying.

5 So, please, if you don't know what
6 I said, ask the reporter to read it back, but
7 please do not characterize my testimony in
8 your own words.

9 Q. Okay --

10 A. Just don't do it.

11 Q. what I am asking you is this. Do
12 any of the members of the MPEG patent pool use
13 any of the technologies of IViewIt?

14 A. I would have no idea.

15 Q. who is the person in charge of the
16 MPEG patent pool, sir?

17 A. Like I say, I advise you to check
18 their web site if you want to know information
19 about that patent pool.

20 Q. well, again --

21 A. It's not me.

22 Q. Are you involved with the MPEG
23 patent pool, sir?

24 A. Yes.

25 Q. what is your position --



1 Rubenstein
2 A. I am counsel to MPEG, LLC.
3 Q. Do you advise the MPEG patent pool
4 with regard to legal issues?
5 A. That's privileged information.
6 Q. Not whether or not you advised
7 them on legal issues.
8 A. You are asking me -- I am not
9 going to discuss with you anything about
10 anything I do with any other client in this
11 law firm.



EXHIBIT K



RESPONDENT POINTS TO HIS LACK OF LACK OF BILLINGS⁵⁰

A. Patent Work: Most of Mr. Bernstein's allegations derive from his claim that Mr. Rubenstein mishandled certain patent work. To the contrary, as we show below (see Section II), there is overwhelming testimonial and documentary evidence showing that this allegation is false. Approximately twenty Proskauer attorneys performed legal services for and billed time to Iviewit matters. Mr. Rubenstein wasn't one of them. Of the almost \$370,000 owed by Iviewit for legal services rendered by Proskauer, Mr. Rubenstein did not bill a minute of time to the engagement. Further, even ignoring Mr. Rubenstein's lack of involvement, no one else at

Proksauer performed patent work for Iviewit. Iviewit's patent work was handled entirely by patent attorneys at other law firms. Whether there were any errors or omissions with the patent work is immaterial. Proskauer simply did not perform that work.

⁵⁰ *Supra* Note 30 at 4.



**BILLINGS OF MR. WHEELER FROM PROSKAUER BOCA RATON, FLA.
OFFICE**

02/18/99 C WHEELER .25 Conf with Mr. Rubenstein

01/14/99 C WHEELER .50 Follow up on status on intellectual property review and new incorporation

01/28/99 A GORTZ .75 Ken Rubenstein call, cf call Eliot Bernstein & Ken Rubenstein, cf Mara Robbins re confidentiality agreement

02/01/99 C WHEELER .25 Conf as to status of intellectual property work

02/16/99 C WHEELER .25 Conf with Mr. Bernstein; call to Mr. Rubenstein

02/17/99 C WHEELER .25 Call to Mr. Rubenstein re patent advice; call with Ms. Coleman re financial advisor

02/18/99 C WHEELER .25 Conf with Mr. Rubenstein

03/16/99 M ROBBINS .50 Inter-office conference with Wheeler re: intellectual property matters.

03/29/99 K HEALY 1.25 Tc w/C. Wheeler; tcs w/Eliot Bernstein re intellectual property protections; tc w/Raymond Joao re patent pending; tcs w/E. Bernstein and Jerry Levin re license business models; review protectability of web-sites

03/31/99 K HEALY .25 Tc w/K. Rubenstein re Patent advice

04/22/99 K HEALY .25 Tc w/R. Joao; e-mail to E. Bernstein

05/12/99 C WHEELER 1.00 Conf with Messrs Bernstein and Lewin; call to R. Joao; transmittal of agreement

05/12/99 C WHEELER .50 Conf with Mr. Joao re stock ownership, subsidiary and patent protection

05/12/99 C WHEELER 2.00 Conf with Joao; meeting with Thompson to arrange for confid. agreements and generic agreements



05/20/99 C WHEELER .75 Conf with Mr. Joao

05/20/99 C WHEELER 2.00 Call to Mr. Lewin; conf with Ken Rubenstein;
conf with Mara Lerner; numerous conf with
Elliot Bernstein

05/20/99 C WHEELER 1.00 Conf with Mr. Joao

05/25/99 C WHEELER 11.00 Trip to Orlando for meeting with Real 3D
technology staff

05/26/99 C WHEELER 1.00 Review of patent; set up patent conference;
arrange follow up on shares;

05/27/99 C WHEELER .50 Conf with Mr. Rubenstein

05/27/99 C WHEELER 1.50 Overview of Iviewit patent matters and
corporate matters

05/28/99 C WHEELER .50 Confirmation on Joao meeting

05/28/99 C WHEELER 2.00 Meeting as to patent issues and management
matters

05/28/99 C WHEELER .50 Conf. w/K.Rubenstein

05/28/99 K HEALY .50 Tcs w/C. Wheeler re IP Issues; review web-site

05/31/99 C WHEELER 1.00 Review of patent and other materials

06/01/99 C WHEELER 4.00 Conf with Mr. Rubenstein; conf with Mr. Lewin;
conf with Mr. Healy; conf with Mr. Joao; conf
with Mr. Akselrod re patents, tax
ramifications, copyright work;

06/01/99 K HEALY 1.50 Conference call w/E. Bernstein, R. Joao, K.
Rubenstein, C. Wheeler, and others re iviewit
I.P. issues; review cd.rom

06/03/99 C WHEELER 2.00 Call to Mr. Joao; call to Mr. Healy; conf with
Mr. Bernstein; review of numerous
correspondence; conf with Mr. Lewin

06/04/99 C WHEELER 2.00 Prep of revised confidentiality agreement; call
to Ms. Bibona; conf with Mr. Joao;

06/11/99 C WHEELER .25 Call to R.Joao



06/16/99 C WHEELER 4.00 Meeting with Mr. Joao and Messrs. Bernstein re patent and other matters

06/23/99 S KAPP .50 Conf. with CCW regarding various matters pertaining to structure, patents, confidentiality agreements

06/18/99 C WHEELER 3.50 Review of patents with Mr. Joao; conf with Mr. Lewin re status; conf with Mr. Bernstein; Check of status of new corporate documents

06/23/99 S KAPP .50 Conf. with CCW regarding various matters pertaining to structure, patents, confidentiality agreements

07/28/99 C WHEELER 3.50 Conf with Mr. Lewin; conf with Mr. Buchsbaum; review of corporate status; conf with Mr. Thompson; review of corres. from Mr. Epstein; call to Mr. Joao; conf with Mr. Wilson; conf with Mr. Joao; call to Mr. Lewin

07/31/99 C WHEELER 1.50 Review and organization of various matters involving meetings, venture capital, patents and prospects

08/04/99 S KAPP .25 T/c with Ray Joao

09/09/99 K HEALY .50 Review files to prepare IP Materials for E. Bernstein and B. Utley

09/10/99 C WHEELER .25 Arrange for patents

09/10/99 C WHEELER 2.00 Conf with Mr. Brandon; conf with Mr. Brandon; conf with Mr. Rubenstein; transmittal of materials to Mr. Rubenstein; Call to Mr. Joao

09/13/99 C WHEELER 1.00 Conf with Mr. Brandon; conf with Mr. Joao;

09/13/99 J ZAMMAS 1.25 Discuss patents with C. Wheeler's secretary;

09/21/99 C WHEELER .25 Call to Mr. Utley re patent meeting

09/21/99 C WHEELER 1.00 Conf with Mr. Utley re patent meeting and status of negotiations; call to Mr. Brandon



09/22/99 J ZAMMAS 3.00 Work on patent binders and trademark binders for C. Wheeler; telephone Raymond Joao regarding all patents; compile all documents by shareholder/noteholder

09/23/99 J ZAMMAS .25 Telephone Raymond Joao regarding patents.

09/24/99 C WHEELER 1.00 Call on utilities; follow up on space requirements; conf on patent questions

09/24/99 J ZAMMAS .50 Update shareholder list; telephone Raymond Joao's secretary regarding patents; advise C. Wheeler.

09/27/99 J ZAMMAS 2.50 Revise consents to indicate that Brian Utley is elected as Chief Operating Officer of the three entities; telephone calls from Mr. Joao's office regarding patents; complete work on patent binders for C. Wheeler; send stock certificate of uview.com, Inc. to Patricia Daniels; send iviewit.com LLC subscription letters to James Armstrong, Andrew Dietz, Lisa Friedstein and James Osterling.

11/29/99 J ZAMMAS .25 Copy official filing receipts for two patents, insert in patent binders and give two copies to Brian Utley to insert in his binders.

01/11/00 C WHEELER 1.00 Conf with Mr. Bernstein re patents and infringement

01/11/00 C WHEELER 1.00 Conf with Mr. Joao re patents

01/11/00 C WHEELER .50 Conf with Mr. Lewin re patents

10/11/00 C WHEELER 1.50 Conf with Mr. Utley re Ken Rubenstein and Time Warner; conf with Mr. Rubenstein



**EXAMPLE OF PROSKAUER BILLING SUMMARY...WHERE IS
RESPONDENT IN LIGHT OF PRIOR BILLINGS**

CLIENT: IVIEWIT.COM, INC.
MATTER: GENERAL CORPORATE ADVICE
PAGE: 5

October 13, 2000

SUMMARY OF HOURS

NAME	HOURS
CHRISTOPHER C. WHEELER	12.25
RICHARD H. ROWE	.25
TOTAL FOR PARTNER	12.50
DONALD E. THOMPSON II	1.00
TOTAL FOR SENIOR COUNSEL	1.00
GAYLE COLEMAN	.25
MARA LERNER ROBBINS	10.00
SUSAN L. WIENER	1.00
TOTAL FOR ASSOCIATE	11.25
JILL B. ZAMMAS	2.75
TOTAL FOR LEGAL ASSISTANT	2.75
TOTAL HOURS:	27.50

DISBURSEMENTS AND CHARGES

DESCRIPTION:	AMOUNT
DELIVERY CHARGES	11.44
LONG DISTANCE TELEPHONE	1.85
REPRODUCTION	13.80
TOTAL DISBURSEMENTS AND CHARGES FOR THIS MATTER:	\$27.09



EXHIBIT L



THE FLORIDA BAR RESPONSE OF MR. WHEELER THAT NAMES WARNER BROS. A CLIENT OF RESPONDENT

II. Iviewit's Complaint Regarding Proskauer's Handling of Iviewit's Relationship with Warner Bros. Stems from Proskauer's Refusal to Place Itself in a Conflict of Interest Position

As is clearly demonstrated by Iviewit's latest submission, its real complaint regarding Warner Bros. is its contention that it has somehow been damaged because Mr. Rubenstein refused Iviewit's requests to vouch for Iviewit's technology to Warner Bros. (a Proskauer client) after Proskauer filed a



LETTER OF MR. COLTER CLAIMING OVERLAPPING OF MR. BERNSTEIN S TEACHINGS

Subj:iviewit
Date:1/14/2002 9:51:08 PM Pacific Standard Time
From:David.Colter@warnerbros.com (DColter0264)
To:John.calkins@warnerbros.com
CC:CHuck.dages@warnerbros.com, Alan.Bell@warnerbros.com (ABell0648)
Sent on: AOL 6.0 for Windows US sub 10551

John,

In all the review we have done with iviewit it seems to boil down to the status of the patents and their inherent value. At that point it is a risk-reward evaluation -- without awarded patents it is difficult to completely assess the value. I would suggest that we consider one other perspective...

Prior to iviewit (approx Feb 2000) the video we (WB Online) delivered on the web was QCIF (160x120) or smaller and was below full frame rate. At the time of our first meeting we also identified On2 along with iviewit as two solid players who could deliver full screen full frame rate web video. All who saw it were impressed. Greg and I visited iviewit in August and reported back that they had filed patents on scaling techniques that hinged upon a visual 'trick' which allowed the human eye to accept 320x240 video scaled to 640x480 at 30 fps as close to VHS quality. We checked with Ken Rubenstein and others who provided some solid support for iviewit, and Chris Cookson asked Greg and I to continue to work with iviewit in an R&D capacity.

In the fall of 2000 iviewit also met with a number of folks at WB Online (in September and October) and demonstrated their process and techniques to Sam Smith, Houston, Joe Annino and others. Sam contacted iviewit a number of times and requested the patents, along with specifics of the iviewit process to evaluate what they were doing. I was not part of these meetings, but was aware they had occurred, as Jack Scanlon kept me up to date.

When I sat down with Morgan and Houston in March 2001 to see what technology they were using to encode video, it was clear that they were using some of the techniques that would overlap with iviewit's filed process patents (still pending), but it is not clear that these were all learned from iviewit -- we may wish to explore this a little. This meeting was to determine what equipment we would get for our lab at 611 Brand. This same information was also provided to iviewit by Morgan as they were establishing the company as an outsourcing facility for encoding our content.

I am aware of several meeting held between iviewit and WB Online to share information of techniques and process, and was invited to a few of them.

We all signed iviewit's confidentiality agreement. So to the other perspective....

We have an opportunity to establish a license with iviewit for a modest fee at this time, and establish a MFN. In good faith we signed the confidentiality agreement, iviewit revealed their processes and techniques, and we now use those techniques in encoding. As we have discussed on a few occasions, these techniques now appear in the public domain to some extent in documentation for Real Producer, WMP Developer Guides, Media Cleaner Pro, etc, but they were not available in 2000. I would not suggest we learned the techniques completely from iviewit (I actually do not know the answer), but a modest licensing fee may be appropriate and honorable considering our good faith relationship in signing the confidentiality doc.

If we choose to pass at this time the risk is primarily from iviewit's main investor, Crossbow Ventures, gaining control of the IP and approaching WB later for a license -- I do not believe they will be as friendly considering their dealings with iviewit and it's employees since Feb of 2001. It is estimated that the patents will be completed in 8-12 months.



As you are all aware I have a personal relationship with Eliot Bernstein, the founder of iviewit, and as a result, I left the evaluations and decisions to Greg, and others, and only assisted iviewit to get to the correct people in WB and AOLTW. I wanted to add this perspective as we consider if there is an option to pursue with iviewit -- they are facing continued financial pressure right now. There are many other threads to our interaction with iviewit and I would be happy to discuss.

Thanx,
David



EXHIBIT M



RESPONDENT IS UNAWARE OF HIS INTEREST IN PROSKAUER

22 Q. Are you a partner of Proskauer
23 Rose?
24 A. Yes.
25 Q. Are you a shareholder of Proskauer

1 Rubenstein
2 Rose?
3 A. One or the other, either partner
4 or shareholder.
5 I think it's a partnership.
6 Q. It's a partnership. Do you have
7 any ownership interest in the partnership in
8 the sense of obligations that go beyond what
9 some of the other partners have? In other
10 words, do you have an equity share? Do you
11 have any other claims with regard to an
12 interest in Proskauer Rose?
13 A. I have no idea.



RESPONDENT IS UNCERTAIN OF HIS START DATE AT PROSKAUER

- 14 Q. And how long have you been
15 employed with Proskauer Rose?
- 16 A. About four, four-and-a-half years.
- 17 Q. Somewhere between 1997 and 1998
18 was your first date of employment?
- 19 A. I think it was in 1998.
- 20 Q. Do you remember a month?
- 21 A. Possibly June.



See CD Folder for Audio Clip - Exhibits for Rubenstein - Exhibit M

**SEE COMPACT DISC, ENCLOSED, OF A TAPED CONVERSATION OF MR.
SHIRAJEE ADVISING OF DISCLOSURES TO RESPONDENT**



**ELECTRONIC MAIL MESSAGE FROM SIMON L. BERNSTEIN, FORMER
CHAIRMAN OF THE BOARD OF DIRECTORS OF THE COMPANY**

-----Original Message-----

From: Alyssa Zeiger [mailto:alyssa@lifeinsuranceconcepts.com]
Sent: Friday, May 16, 2003 10:33 AM
To: 'iviewit@worldnet.att.net'
Cc: 'simon@lifeinsuranceconcepts.com'
Subject: FW: response to your letter

Eliot,

Here is my account of those questions you of asked for regarding iviewit Technologies, Inc.

1. Not having Wheeler's testimony it's difficult for me to respond to the 1st question. However, Real 3d (Jerry Stanley) was introduced to us and their opinion including the opinion of their engineering staff was that the patents that we showed them were outstanding and extremely valuable. Mr. Stanley told myself, Eliot, Jerry Lewin and Chris Wheeler that we were onto something big.
2. The problems that were encountered by Ray Joao's work were that is seemed to be incomplete, sloppy and certainly not in a professional manner for which the billings indicated it were. With regard to Foley and Lardner's work, there work also seemed to be incomplete with regard to accomplishing the patent approvals. It was also noted that including work with Mr. Utley they were writing patents in his name.
3. In the same regard Mr. Utley told me when I confronted him with this that it was common for the writer to put new patents in his name but assured me that all patents were assigned to iviewit Technologies, Inc. This was passed on to one of the partners at Proskauer Rose and I was assured that this with in proper conduct.
4. With regard to Ken Rubenstein, I was told by Brian Utley and Chris Wheeler that he was a partner of Proskauer Rose and that he was in fact overseeing our patent work and it also was mentioned that he advised the board of directors with regard to raising capital.
5. It is my opinion that Hank Powell a partner of Crossbow Ventures and also a member of the board of iviewit Technologies, Inc. violated his fiduciary responsibility as said board member to iviewit Technologies, Inc. by recommending iviewit Technologies, Inc. move forward and securing additional loans from Crossbow Ventures. He also told me that Crossbow had no intention of ever collecting on the notes but in fact it gave further protection of iviewit Technologies, Inc. from any other creditors. It is my opinion that this convinced the board of directors to vote on such loans.



6. With regard to Chris Wheeler's recommendation of Bryan Utley it's my opinion that he knew of the past problems Mr. Utley had with Monte Friedkin and withheld this information to myself and to Eliot.
7. My understanding of the relationship between Mr. Utley and Mr. Wheeler is that they are good friends both socially and professionally. Also they served on many boards together.

I believe this covers the pertinent questions you asked me for. I hope this helps.



STATEMENT OF GUY IANTONI, FORMER VICE PRESIDENT OF SALES OF THE COMPANY

June 13, 2003

The following information may be used as my sworn testimony in describing the history and events relating to iviewit (The Company) and its affiliated management and advisors.

As an existing shareholder and personal investor in the Company, I am appalled by the fraud and mismanagement demonstrated by the former President, Brian Utley and legal counsel including: Raymond Joao, Kenneth Rubenstein, Christopher Wheeler and others. I was an employee of the Company since its inception in 1998 to February 2001. I was personally in meetings where Christopher Wheeler recommended Brian Utley as a strong candidate for the President position at iviewit with his experience at IBM. I was one of the first individuals to witness iviewit's zoom and pan technology as well as full-screen, full-frame rate video streaming. I recall viewing iviewit's technologies as early as February of 1998. I attended many meetings with the technologies inventors: Eliot Bernstein, Jude Rosario and Zakirul Shirajee at iviewit's Florida office and witnessed several meetings between the inventors and Raymond Joao. I had discussions with Eliot Bernstein in late 1999 when Eliot expressed his reservations and concerns that the patent work of Raymond Joao, Kenneth Rubenstein and Brian Utley was both incomplete and not representative of the inventors' true findings. I was also present later 1999-2000 as William Dick and Foley and Lardner continued the errors in the patents caused by Raymond Joao and Kenneth Rubenstein.

My personal investment into the Company was largely due to the remarks of attorney Kenneth Rubenstein on a conference call with Eliot Bernstein stating " iviewit's technology will be extremely valuable as part of the MPEG patent pool." I helped author many business plans with Eliot Bernstein, Jim Armstrong, Wachovia Securities and others including Kenneth Rubenstein as a key Company advisor. I attended many face-to-face meetings where Christopher Wheeler both witnessed iviewit's technology and introduced potential clients and investors to the management team. Mr. Wheeler had hand picked the management team and controlled their actions.

It was abusive the amount of unnecessary legal services generated by Christopher Wheeler and Proskauer Rose at such an early stage in the Company's development as we were mislead to believe that these costs would offset revenue by Wheeler/Rubenstein/PR clients and patent pool royalties. I recall the company going through several legal changes including: C-corp, several LLCs, Holding companies, name changes etc. I was stunned to hear that the Company had hundreds of thousands of payables due Proskauer Rose. Brian Utley had primary fiduciary responsibility (or more like irresponsibility) for the use of all investment proceeds, legal services and vendor contracts.

I welcome the opportunity to be personally involved in defending the Company and its assets

Sincerely,

Guy T. Iantoni



STATEMENT OF JAMES F. ARMSTRONG, FORMER VICE PRESIDENT OF SALES & MARKETING OF THE COMPANY

Wednesday, April 30, 2003

Mr. Eliot I. Bernstein
10158 Stonehenge Circle
#801
Boynton Beach, FL. 33437-3546

Dear Eliot,

I have spent the past several evenings reviewing the depositions taken from Wheeler, Utley and Rubenstein and I am stunned. The extent of their lies and their orchestrated obfuscation compels me to reduce to writing some of the experiences that I had with these men. Please use this letter and the statements contained herein as my sworn statement of fact in your continuing effort to expose the truth, punish the evil and reward the deserving.

As a friend of Eliot's, since childhood, I was aware of iviewit from its beginnings but it was only after learning from Chris Wheeler about Ken Rubenstein's favorable opinion regarding iviewit's video and imaging technologies that I became seriously interested in the company. I resigned from a lucrative senior management position with Prudential Securities to help Eliot with his "project". Ultimately, I invested over \$20,000 and declined significant career opportunities in order to begin formally working for iviewit in the fall of 1999. Amongst the most egregious of the statements contained in the depositions is that made by Ken Rubenstein when he claims he does not know iviewit or anything about its technologies or processes. Ken is one of the primary reasons why I and many others invested their time and resources in the company. It was the extremely positive opinions of this highly respected attorney, who has direct links to the MPEG patent pool, which compelled so many of us to make the commitments that we made. Mr. Rubenstein is lying in his deposition.

Similarly, Chris Wheeler denies having any role in the patent work performed for iviewit other than referring us to patent counsel that ultimately ripped us off (but that's a different issue). Eliot, you have done a fine job putting together the billing evidence which is irrefutable. Not only did Wheeler play an instrumental and ongoing role in the handling of the patents, he was the primary contact point with Ken Rubenstein. I also remember Chris, in a meeting held at Real 3D, espousing the novelty of iviewit's inventions and discussing the apparent absence of any prior art in this area. In addition, Chris publicly shared Ken Rubenstein's opinion that the iviewit technologies were "novel". It was during this meeting of Intel and Lockheed engineers that a member of Real 3D's senior management, Rosalie Bibona, stated that iviewit's inventions could be worth billions of dollars. Wheeler states in his deposition that he was unfamiliar with any video inventions until sometime after the Real 3D meeting. Mr Wheeler is lying and everyone present at that meeting can testify to that fact. I was at a meeting held at Si Bernstein's house where Eliot Bernstein, Gerry Lewin, Chris Wheeler, Si Bernstein and Hassan Mia were in attendance. This meeting took place prior to the Real 3D meeting and its purpose was to show Hassan the video streams. It was at this meeting that



Hassan Mia stated "... if what I'm seeing is true, you've found the Holy Grail". The term "Holy Grail" can be found in many early versions of iviewit's business plans.

Let's talk about Brian Utley. This man is a stammering buffoon. Were it not for his resume full of accomplishments and the glowing recommendation of our trusted counsel, he probably never would have passed an initial candidate screening. Unfortunately, we learned too late that many of Brian's accomplishments were fabricated and our trusted advisor, Chris Wheeler, was a liar. I remember a meeting of Eliot, Guy Iantoni, Brian Utley, Mike Reale, Si Bernstein, Chris Wheeler and two investment bankers from Wachovia, Mr. Joe Lee and his associate (I forget his name). Guy and I had prepared a detailed sales forecast that Joe Lee later referred to as the most complete and detailed he'd ever seen. Brian's task was to complete the financials for Joe's review. The work that he presented to Joe Lee was pitiful; it was incomplete, inaccurate and inadequately referenced. In short, it was a disastrous embarrassment. We soon learned that that was the best Utley could deliver. Joe Lee insisted that I complete the financial projections for the business plan and that Utley be removed from the project. This is the sort of talent that our trusted advisor, Chris Wheeler, brought to his client!

From unauthorized patent disclosure to Danny Sokoloff without the protection of an NDA to outright patent sabotage through the use of bad math in patent applications, Utley never failed to disappoint. He was equally inept in corporate matters. I notified Brian on numerous occasions of the firm's responsibility to communicate to shareholders at least once per year and that iviewit was in default on its notes for not having made an interest payment. Like a child, he chose to bury his head in the sand instead of addressing the problem. His exorbitant use of T&E monies is legend and is only exceeded by his inability to complete a sentence without the excessive use of the word "um".

As they say, "hindsight is 20/20". In this case, it's now clear that Wheeler never had iviewit's interests in mind. He was positioning himself and his friends to benefit from iviewit's inventions and creativity. What makes his crime so heinous is that he masqueraded as our friend.

Sincerely,

James F. Armstrong
126 Buttonwood Drive
Fair Haven, NJ. 07704
732-747-4353
email: jjarmstrong@comcast.net



STATEMENT OF SHAREHOLDER MITCHELL A. WELSCH, CFP

Date: 12/11/02

Dear Eliot;

I wanted you to know how I feel about all that I have read recently. As a shareholder and someone that has been around this company since the beginning, I don't know how lawyers like Chris Wheeler and law firms like Proskower Rose could allow statements in a business plan that are not true. Therefore, if the business plan were correct then Mr. Utley would have to be lying under oath. In todays world of fair disclosure, this kind of inconsistency makes me outraged. As a shareholder I encourage and would support action taken to bring any wrongdoing to justice. If nothing else, I am unwilling to allow these deceptions to continue. We should pursue action and be compensated for wrongdoing. I know that if Mr. Rubinstein had not been involved with Iviewit it would have significantly affected my decision to contribute funds when I did. His involvement was communicated to me by Mr. Utley, Mr. Wheeler as well as other involved with the company but as legal representation and president of the company they carried the greatest weight. These inconsistencies are unacceptable and criminal in my opinion. What can we do to bring resolution to this situation and whom do we hold accountable?

Sincerely;

Mitchell A. Welsch, CFP

Mitchell A. Welsch CFP



PASSAGES FROM DEPOSITION OF JERRY LEWIN A PRINCIPAL OF GOLDSTEIN LEWIN, AND THE COMPANY S FORMER OUTSIDE AUDITOR⁵¹

17 Q. Do you recall ever having discussions or
18 hearing discussions among principals of Iviewit that
19 they weren't happy with Proskauer's services?

20 A. The only discussions related was -- Was
21 it Ken Attelman, the one that -- Who was --

22 Q. I can't - I can't answer that.

23 A. You can't answer. There was an attorney
24 in New York that was supposed to oversee the - or
25 involved somehow with the patent. And the

KEN SCHANZER & ASSOCIATES, INC. (954) 922-2660

17

1 discussions were related to was he doing a good
2 enough job overseeing Foley's firm, you know,
3 handling the patent or he supposed --

4 Q. Is this Ken Rubenstein?

5 A. KEN RUBENSTEIN. That's the guy, yes.
6 There were discussions related to Ken Rubenstein and
7 the patents. That was it.

8 Q. Who had those discussions? Who were the

⁵¹ Deposition of Gerald Lewin at 16-17, *Proskauer Rose LLP v. Iviewit.com, Inc. et. al.* Case No. CA 01-04671 AB (Circuit Court of the 15th Judicial Circuit in and for Palm Beach County, Florida filed May 2, 2001).



...STILL MORE MR. LEWIN⁵²

5 Q. Did Proskauer do patent work for Iviewit?

6 A. I'm trying to remember. They did consult
7 an attorney in New York, one of Proskauer's attorneys
8 in New York. I don't recall his name. And I do have
9 to tell you I'm not very good with names.

17 Q. Were there any disagreements concerning
18 the manner in which the patents had been filed or the
19 names under which the patents had been filed?

20 A. I don't recall on the names. I recall
21 there were maybe disagreements of - you know, which I
22 don't understand - I do not understand patents - of
23 whether papers were prepared this way or that way or
24 properly or improperly or -- You know, maybe those
25 were discussions.

⁵² *Supra* Note 49 at 55-56.



EXHIBIT N



SECTION 115 OF PATENT ACT

TITLE 35 PART II CHAPTER 11 Sec. 115.

Sec. 115. - Oath of applicant

The applicant shall make oath that he believes himself to be the original and first inventor of the process, machine, manufacture, or composition of matter, or improvement thereof, for which he solicits a patent; and shall state of what country he is a citizen. Such oath may be made before any person within the United States authorized by law to administer oaths, or, when, made in a foreign country, before any diplomatic or consular officer of the United States authorized to administer oaths, or before any officer having an official seal and authorized to administer oaths in the foreign country in which the applicant may be, whose authority is proved by certificate of a diplomatic or consular officer of the United States, or apostille of an official designated by a foreign country which, by treaty or convention, accords like effect to apostilles of designated officials in the United States, and such oath shall be valid if it complies with the laws of the state or country where made. When the application is made as provided in this title by a person other than the inventor, the oath may be so varied in form that it can be made by him. For purposes of this section, a consular officer shall include any United States citizen serving overseas, authorized to perform notarial functions pursuant to section 1750 of the Revised Statutes, as amended (22 U.S.C. 4221)



EXHIBIT O



LETTER OF MR. COLTER DESCRIBING RESPONDENT S INVOLVEMENT

-----Original Message-----

From: David.Colter@warnerbros.com [mailto:David.Colter@warnerbros.com]

Sent: Wednesday, August 01, 2001 10:28 PM

To: HeidiKrauel@aol.com

Cc: HPowell@cb-ventures.com; Eliot@iviewit.com

Subject: Re: Today -- iviewit

Heidi,

Here is the info for Hank Powell from Crossbow Ventures. I have copied him above to make the introduction.

iviewit has undergone a restructuring of their business from an encoding focused business to a technology licensing business focus over the past 4-5 months. They are in the process of establishing a new executive team to handle this 'new' direction and have been working on the new business plan. They have indicated that we should have the revised plan next week.

They currently are finalizing a contract with WB Online to provide encoding services as a hold over from our original collaboration, and as a showcase for the technologies and patents.

Their site www.iviewit.com contains good demonstrations of the zooming and video encoding technologies. I have also copied the inventor/founder Eliot Bernstein, who I will ask to provide some specific links on the site to see the best representation of their work and technical capabilities.

Their patents are pending, but have received favorable opinions from people such as Ken Rubenstein on the merit of the patents, as well as thorough review by Greg Thagard and myself.

Let's talk further after you see the business plan and connect with Hank.

Thanx,
David



ANOTHER LETTER OF MR. COLTER DESCRIBING RESPONDENT S INVOLVEMENT

From: David.Colter@warnerbros.com
Sent: Tuesday, January 15, 2002 12:51 AM
To: John.calkins@warnerbros.com
Cc: CHuck.dages@warnerbros.com; Alan.Bell@warnerbros.com
Subject: iviewit

John,

In all the review we have done with iviewit it seems to boil down to the status of the patents and their inherent value. At that point it is a risk-reward evaluation -- without awarded patents it is difficult to completely assess the value. I would suggest that we consider one other perspective...

Prior to iviewit (approx Feb 2000) the video we (WB Online) delivered on the web was QCIF (160x120) or smaller and was below full frame rate. At the time of our first meeting we also identified On2 along with iviewit as two solid players who could deliver full screen full frame rate web video. All who saw it were impressed. Greg and I visited iviewit in August and reported back that they had filed patents on scaling techniques that hinged upon a visual 'trick' which allowed the human eye to accept 320x240 video scaled to 640x480 at 30 fps as close to VHS quality. We checked with Ken Rubenstein and others who provided some solid support for iviewit, and Chris Cookson asked Greg and I to continue to work with iviewit in an R&D capacity.

In the fall of 2000 iviewit also met with a number of folks at WB Online (in September and October) and demonstrated their process and techniques to Sam Smith, Houston, Joe Annino and others. Sam contacted iviewit a number of times and requested the patents, along with specifics of the iviewit process to evaluate what they were doing. I was not part of these meetings, but was aware they had occurred, as Jack Scanlon kept me up to date.

When I sat down with Morgan and Houston in March 2001 to see what technology they were using to encode video, it was clear that they were using some of the techniques that would overlap with iviewit's filed process patents (still pending), but it is not clear that these were all learned from iviewit -- we may wish to explore this a little. This meeting was to determine what equipment we would get for our lab at 611 Brand. This same information was also provided to iviewit by Morgan as they were establishing the company as an outsourcing facility for encoding our content.

I am aware of several meetings held between iviewit and WB Online to share information of techniques and process, and was invited to a few of them.

We all signed iviewit's confidentiality agreement. So to the other perspective....

We have an opportunity to establish a license with iviewit for a modest fee at this time, and establish a MFN. In good faith we signed the confidentiality agreement, iviewit revealed their processes and techniques, and we now use those techniques in encoding. As we have discussed on a few occasions, these techniques now appear in the public domain to some extent in documentation for Real Producer, WMP Developer Guides, Media Cleaner Pro, etc, but they were not available in 2000. I would not suggest we learned the techniques completely from iviewit (I actually do not know the answer), but a modest licensing fee may be appropriate and honorable considering our good faith relationship in signing the confidentiality doc.

If we choose to pass at this time the risk is primarily from iviewit's main investor, Crossbow Ventures, gaining control of the IP and approaching WB later for a license -- I do not believe they will be as friendly considering their dealings with iviewit and its employees since Feb of 2001. It is estimated that the patents will be completed in 8-12 months.

As you are all aware I have a personal relationship with Eliot Bernstein, the founder of iviewit, and as a result, I left the evaluations and decisions to Greg, and others, and only assisted iviewit to get to the correct people in WB and AOLTV. I wanted to add this perspective as we consider if there is an option to pursue with iviewit -- they are facing continued financial pressure right now. There are many other threads to our interaction with iviewit and I would be happy to discuss.

Thanx,
David



STATEMENT OF CEO LAMONT

I met with Mr. Rubenstein in the New York offices of Proskauer Rose LLP on Monday January 7, 2002 at 11:30 A.M. Moreover, the purpose of my visit was three fold: (I) to invite him to **REJOIN** the Advisory Board along with David Colter, Vice President of Advanced Technology of Warner Bros. and Greg Thagard, formerly of Warner Bros. and left with him a copy of the Company's January 2002 Business Plan, an Advisory Board Member Agreement, and a Warrant Grant to purchase 450 share of the Company as compensation; (II) to begin a series of discussions pointing to the essentiality of the Iviewit patents pending in his role as patent evaluator of the multimedia patent pools known as MPEG 2 and MPEG 4; and (III) to have a face to face discussion as a means to allow me to ask him to speak to Wayne M. Smith, Vice President & Senior Litigation and Patent Counsel at Warner Bros. to reiterate his prior statements to Warner Bros. executives and overcome his purported conflict that was previously waived. Much to my surprise, during our discussion, Mr. Rubenstein disavowed any knowledge of the Company's patents pending, at which time I felt a bit of embarrassment. Embarrassed, because, once assuming the CEO position, I had prior knowledge of his speaking to people at Warner Bros., such as, but not limited to David Colter, Greg Thagard, and Chris Cookson, and thought I might have interpreted an incorrect picture of those prior discussions. Lastly, I advised him of my discussions with Warner Bros. pertaining to an Advanced Royalty Agreement ("ARA").

Moreover, in reviewing Company documentation, I came across more instances of business plans naming him as an Advisory Board Member, multiple emails of investors and potential licensees naming Mr. Rubenstein as an individual entirely familiar with the Company's technologies, and parole evidence stating that Mr. Rubenstein, when initially the recipient of the Company's disclosures claimed the technologies were "novel," and that "he had missed that," and that "we had never thought of that," and finally that "this changes everything."

Furthermore, although I became a bit suspicious after the meeting with Mr. Rubenstein, and as the Warner Bros. discussions began to break down due to Mr. Rubenstein's reticence at speaking to Warner Bros., I felt comfortable enough in asking Mr. Rubenstein to place a phone call to Mr. Smith of Warner Bros., for what amounts to the third time, who was the patent attorney assigned the task of reviewing the Company filings for purposes of evaluating the ARA and the AOL Time Warner investment. Mr. Smith had been requesting a conversation with Mr. Rubenstein dating back to December 20, 2001, for the purposes of describing for good or bad his aforementioned knowledge of the Company's patents pending, and that he had formerly described as "novel," on varied occasions to Mr. Colter, Mr. Thagard, and others at Warner Bros. At this point, and based on nearly ten years experience as a technology executive, I suspected that something was wrong in the Company's patent filings, as in my prior experiences, the patent applications or patents issued usually had spoken for themselves, but in this instance, Mr. Smith was seemingly interested in a check of his reading and view of the Company's filings.



Much to my surprise, **AGAIN**, Mr. Rubenstein, not now disavowing knowledge of the Company's patents pending, refused said request based on conflicts of interest as Warner Bros "is a big client here." Surprised, **YET AGAIN**, as I was aware of his prior representations to Warner Bros. where no conflicts of interests were stated, at least not to my knowledge and in my review of Company documentation, I may have advised Mr. Rubenstein in still another phone conversation, that his purported conflicts of interest were waived on both sides, but that at least "could Mr. Smith call you [Mr. Rubenstein]," to which he agreed, however, paraphrasing, "he would not be positive or negative" in that regard. Moreover, he refused to place calls himself much in the same way as he had previously, only this time with anxiety and/or anger in his voice. Subsequent to his refusal, Warner Bros. declined the ARA and AOL Time Warner declined an investment in the Company, based on their confusion surrounding the lack of critical elements of the inventions in the Company's patents pending.

Additionally, it appears that Mr. Rubenstein's refusal to again speak affected not only the Warner Bros ARA, the AOL Time Warner investment, but had direct impact on the next discussions with, including but not limited to, SONY Corporation and what was to become Movielink, LLC (a five studio digital download movie service that was to generate licensing revenue for the Company as envisioned by the Company's business plans).

Still further, as my suspicions grew, I consulted with the Company's founder and main inventor, Mr. Bernstein, who contacted Caroline P. Rogers, Esq. to enlist her help in finding a law firm to conduct an independent review of the Company's patents pending. As of April 2002, the Chicago office of Greenberg Traurig LLP submitted their review at the behest of Ms. Rogers, and advised the Company of the missing critical elements of the Company's inventions that would materially not support the claims in said filings.

Lastly, much to my dismay, and when viewing the Company's inventions as a direct, competitive threat to, including but not limited to Mr. Rubenstein's MPEG 2 and MPEG 4 patent pools of which Mr. Rubenstein who, by his own admission is counsel to the MPEGLA LLC entity that functions as licensor of those pools, and is, to the best of the Company's knowledge, the patent evaluator who decides the "essentiality" of any patent with a view to admission to those pools, my suspicions grew even stronger.

As a result of discussions on the events with Mr. Bernstein, and by my own hand, I drafted the following letter to Mr. Rubenstein on April 25, 2002, and as evidenced by right clicking the document and choosing "Properties" wherein it evidences the date of creation and the date of modification (despite the WORD document's "update automatically" function), not so much, as it appears as an invitation to engage, but as a mechanism to allow Mr. Rubenstein to "save his soul," as my suspicions of the events surrounding the Company's patent prosecution process from 1998 to 2001, were grave indeed; I have knowledge that this letter, in draft form, was submitted to Mr. Rubenstein in his deposition in the Litigation, where he was given time to read and comment upon its contents:



Draft

6/18/2003



IVIEWIT HOLDINGS, INC.

P. Stephen Lamont
Chief Executive Officer
Direct Dial: 914-217-0038

By Electronic Mail and Facsimile

June 18, 2003

Kenneth Rubenstein
Partner
Proskauer Rose LLP
1585 Broadway
New York, NY 10036

Re: Iviewit Patents Pending

Dear Ken:

Last we spoke, Wayne Smith of Warner Bros. requested a conversation with you pertaining to Iviewit patents pending, of which you denied indepth knowledge of same and, additionally, stated conflict of interest issues. Sadly, Iviewit has submitted Return of Property papers and a soon to be issued Cease and Desist letter to Warner Bros. for breach of a Confidentiality Agreement executed in August 2000, and ignorance of a reasonable license agreement to remedy said breach.

In any event, I am writing for another reason as I came across a piece of perplexing information earlier today. I stumbled upon some documentation that named you as an Advisory Board member of the company somewhere between the fall of 1999 and the spring of 2000.

Moreover, recalling your own words, as I sat in your office earlier in the year, of your present unfamiliarity with the Iviewit techniques and unwillingness to speak on behalf of what I have since heard you describe as "novel" approaches to video perplexes me to a certain extent when I view you as a former Advisory Board member, if you ever held such a designation.

Further, and I should not be relaying this to you, but there are rumors swirling around the company with finger pointing and all from Florida to Los Angeles wherein it catches the jet stream and arrives very soon in New York of alleged breaches of confidentiality pertaining to Iviewit technology, transfers of trade secrets, and, even in certain circumstances, knowing and willful invention fraud by the outright switching of signature



Draft

6/18/2003



Kenneth Rubenstein
June 18, 2003
Page 2

pages of patent filings by some earlier patent counsels appointed by the company, including, but not limited to one Mr. Ray Joao, formerly, it is my understanding, of Meltzer, Lippe, Goldstein & Schlissel, P.C., and an individual that, it is also my understanding, you have worked closely with in the past pertaining to Iviewit and other matters. Moreover, it is also my understanding, that you were the first individual to be presented with the Iviewit proprietary techniques, and passed along the work to your past associate, Mr. Joao, and "reviewed" same prior to, during, and, perhaps, after your transition from the Meltzer firm to Proskauer, and in whatever capacity "reviewed" refers to.

At this juncture in my tenure as Iviewit CEO, I have ordered a full legal audit of the company both from a business perspective and an intellectual property perspective. With the results of said audit nearly complete, the preliminary intellectual property conclusions relayed astound me to the point that I have been told that the Iviewit patents pending are akin to patenting "peanut butter."

Furthermore, I have been told of your past involvement with the Iviewit proprietary techniques, of your conversations about the Iviewit techniques with, including, but not limited to, Greg Thagard, Greg Cookson, and David Colter among others, and your initial conclusion of the novelty of the Iviewit techniques, and I ask myself, "Why, why has past patent counsel failed to patent the inventions as specified by our inventor?" Moreover, I ask myself "Why do the description of the inventions fail to lead one to believe that Iviewit had invented anything at all?"

Still further, I think back to the comments I have heard of your initial reaction to the Iviewit techniques and describing them as "novel," which leads me to the conclusion that in your role as overseer of many patent pools, combined with your description of the novelty of the Iviewit techniques, you had not seen scaling in your review of patents pertaining to the essentiality of any given pool, and I ask myself further, "Why is the Iviewit scaling method now so far reaching and ubiquitous in many, varied patent pools overseen by yourself and others of similar stature?"

As such, I would like to enlist your assistance, if available, to review the conclusions of past and present patent counsel, and to further assist Iviewit in further defining the inventions in any intellectual property arena of our choosing, whether it be by a petition by what process is available at the United States Patent and Trademark Office, or any administrative, state, or federal court of appropriate jurisdiction armed with executed



Draft

6/18/2003



Kenneth Rubenstein
June 18, 2003
Page 3

documents, memos, emails, and parole evidence all pointing to fraudulent, or at the least entirely malpractical occurrences regarding the filings of the past Iviewit patents pending.

Lastly, as I mentioned above, I have ordered a full legal and accounting audit of the company many weeks ago, and I expect the completion of same shortly, and I would appreciate a response at your earliest convenience.

Best regards,

P. Stephen Lamont
Chief Executive Officer



EXHIBIT P



FOLEY & LARDNER S REQUEST FOR MR. JOAO S DOCUMENTS

JUN. 6.2000 3:36PM 33RD FLOOR

NO. 920 P. 1/8

Atty. User ID: 0128 Client/Matter Code: 57103/101

FOLEY & LARDNER Attorneys at Law

Sender's Direct Line: (414) 297-5718

Firststar Center 777 East Wisconsin Avenue Milwaukee, Wisconsin 53202-5367 TELEPHONE (414) 271-2400 FACSIMILE (414) 297-4900

FACSIMILE TRANSMISSION COVER SHEET

TO: Mr. Brian G. Utley COMPANY NAME: Iviewit.com, Inc. COMPANY LOCATION: Boca Raton, Florida COMPANY PHONE NUMBER: TEL: (561) 999-8899 COMPANY FAX NUMBER: FAX: (561) 999-8810 FROM: Douglas A. Boehm DATE: June 6, 2000

TOTAL NUMBER OF PAGES INCLUDING COVER SHEET: 8

IF THERE ARE ANY PROBLEMS WITH THIS FACSIMILE TRANSMISSION, OR IF YOU HAVE NOT RECEIVED ALL OF THE PAGES, PLEASE CALL 414/297-5444.

CONFIDENTIALITY NOTICE: THE INFORMATION CONTAINED IN THIS FACSIMILE MESSAGE IS INTENDED ONLY FOR THE PERSONAL AND CONFIDENTIAL USE OF THE DESIGNATED RECIPIENTS NAMED ABOVE. THIS MESSAGE MAY BE AN ATTORNEY-CLIENT COMMUNICATION, AND AS SUCH IS PRIVILEGED AND CONFIDENTIAL. IF THE READER OF THIS MESSAGE IS NOT THE INTENDED RECIPIENT OR ANY AGENT RESPONSIBLE FOR DELIVERING IT TO THE INTENDED RECIPIENT, YOU ARE HEREBY NOTIFIED THAT YOU HAVE RECEIVED THIS MESSAGE IN ERROR, AND THAT ANY REVIEW, DISSEMINATION, DISTRIBUTION, OR COPYING OF THIS MESSAGE IS STRICTLY PROHIBITED. IF YOU HAVE RECEIVED THIS MESSAGE IN ERROR, PLEASE NOTIFY US IMMEDIATELY BY TELEPHONE AND RETURN THE ORIGINAL MESSAGE TO US BY MAIL. THANK YOU.

Brian, Here is your copy of what was just faxed to Mr. Lewis S. Meltzer.

Fax Operator: Time Sent:



JUN. 6.2000 3:36PM 33RD FLOOR

NO. 920 P.2/8

FOLEY & LARDNER

ATTORNEYS AT LAW

CHICAGO
DENVER
JACKSONVILLE
LOS ANGELES
MADISON
MILWAUKEE
ORLANDO

FIRST STAR CENTER
777 EAST WISCONSIN AVENUE
MILWAUKEE, WISCONSIN 53202-5307
TELEPHONE (414) 271-2400
FACSIMILE (414) 297-4800

SACRAI
SAN
SAN FRAN
TALLAH
WASHINGTON
WEST PALM E

EMAIL ADDRESS
daboehm@foleylaw.com

Via Facsimile

WRITER'S DIREC
(414) 297-

June 6, 2000

Mr. Lewis S. Meltzer
Meltzer, Lippe, Goldstein & Schlissel, P.C.
190 Willis Avenue
Mineola, New York 11501

Re: Transfer of IP files for IVIEWIT.COM

Dear Mr. Meltzer:

As you may recall, I am the patent attorney at Foley & Lardner that is currently handling the Iviewit.com IP matters that were previously handled by Ray Joao of your firm.

I recently received the following correspondence from your firm: (1) the original Assignment recorded in the United States Patent and Trademark Office (USPTO) for your Docket No. 5865-8 (U.S. Provisional Patent Application No. 60/169,559); and (2) the USPTO Filing Receipt (copy attached) for your Docket No. 5865-1 for Application No. 09/522,721. Although I sincerely appreciate your firm's diligence in continuing to forward Iviewit materials to me, this latest correspondence raises some very serious issues with respect to the Iviewit.com IP matters that were supposed to have been transferred to Foley & Lardner.

I was not previously told about this U.S. Non-Provisional Application being filed (item 2 above). It does not appear in any of the correspondence previously sent to Foley & Lardner. This raises the question of exactly what was filed in the U.S. Patent and Trademark Office, since I do not have a copy of any filing papers for this application. Was a U.S. Declaration filed? What specification and claims were filed? Was an Assignment filed for this application? I must have this information in order to take over prosecution of this application.

More importantly, however, this raises the question of whether any other provisional or non-provisional applications have been filed in the United States or any other country. Both the client, Brian Utley, President of Iviewit.com, and myself have previously asked your firm to transfer all of the Iviewit.com Intellectual Property files to me. (See attached letter to you dated April 28, 2000.) When the files that were sent to me were incomplete, I sent an e-mail (copy attached) to Dawn Laffin of your firm, asking her to look for other Iviewit matters. I subsequently requested that Nicole, Ray's former secretary,

001.793919.2

ESTABLISHED 1842

A MEMBER OF GLOBALEX WITH MEMBER OFFICES IN BERLIN, BRUSSELS, DRESDEN, FRANKFURT, LONDON, SINGAPORE, STOCKHOLM AND STUTTGART



JUN. 6.2000 3:37PM 33RD FLOOR

NO. 920 P. 3/8

FOLEY & LARDNER

Mr. Lewis S. Meltzer
June 6, 2000
Page 2

double-check that there were no other miscellaneous files that were not on the list of applications (also attached). Now I find out that, after three or four separate requests, all of the Iviewit patent matters were not transferred to us.

I formally request that you have your firm's Docket Administration Department review all of Ray Joao's files to ensure that all of the Iviewit.com materials have been transferred to me. Please forward all letters, memorandums, faxes, e-mails, notes, CD's, disks, and other correspondence between Iviewit.com and your firm, and between any third parties and your firm on behalf of Iviewit.com. It is particularly important that I know which patent applications were filed and what correspondence was submitted to the U.S. Patent & Trademark Office before the expiration of a critical date. Otherwise, the client could possibly lose patent rights. Please confirm that the attached "Iviewit.com Patent Portfolio" table, which lists the patent applications filed for Iviewit.com by your firm, is accurate and complete.

I also request that you contact Ray Joao to confirm which applications were filed in what countries and whether or not Ray has any additional Iviewit correspondence or materials that were not transferred to Foley & Lardner.

Furthermore, the client requests that I obtain a written confirmation from both you and Ray that all files, materials, and correspondence have been transferred to Foley & Lardner.

Please confirm receipt of this facsimile and let me know that these matters will be handled promptly and appropriately.

Very truly yours,

Douglas A. Boehm

Enclosure(s)

cc: Mr. Brian Utley, Iviewit.com



Boehm, Douglas A.

From: Boehm, Douglas A.
Sent: Tuesday, May 09, 2000 5:28 PM
To: 'djaffin@mlg.com'
Subject: iviewit.com Files

Dawn --

As I mentioned on the telephone this afternoon, I received your Federal Express package this morning containing the Meltzer, Lippe files for iviewit.com. The package contained 7 folders corresponding to your docket numbers 5865-1,3,4,4.1,5,6, and 7. However, the file folder for your docket no. 5865-8 is missing. Furthermore, not all of the paperwork for the PCT application (your docket no. 5865-10) was included in the first file 5865-1 (which is the PCT's parent case). Is there a 5865-10 file also?

During our phone conversation, you agreed to review your docket and files for 5865-8, 5865-10, and any other 5865 matters for iviewit.com tomorrow, and forward these files to me right away.

Thanks for your assistance.

--Doug

*Douglas A. Boehm
Foley & Lardner
777 East Wisconsin Avenue
Milwaukee, Wisconsin 53202
Tel: (414)297-5718
Fax: (414)297-4900
Email: dab Boehm@foleylaw.com*

NOTE: The information transmitted in and/or attached to this message is intended only for the person or entity to which it is addressed and may contain confidential and/or privileged material. Any review, retransmission, dissemination, or other use of, or taking any action in reliance upon, this information by persons or entities other than the intended recipient is prohibited. If you received this information in error, please contact the sender and delete the material from any computer.



TRANSCRIPTION OF TELECONFERENCE⁵³ REFERENCING MR. JOAO S DESTRUCTION OF NOTES AND OTHER PATENT MATERIALS

Simon Bernstein: I just have one question. Does anybody have, or are we allowed to get, the files of Ray Joao?

Boehm: I have them.

Wheeler: Do you have all of the work that he had?

Bernstein: No, not all of it.

Utley: What was purported to be in the files?

Bernstein: And he also claimed to us that he destroyed part of his files.

Boehm: And I have some of his files. I have what was purported to be all of the firms' files.

<Inaudible comment.>

Utley: Well, there's a whole history, then, because I tried to get complete copies of the files originally, and found out later that not only did he not send us all the files, he didn't even mention that there was an extra filing out there that we didn't even know about.

Bernstein: This one that's in question.

Boehm: Yep

Simon Bernstein: You have no notes, no data on...?

Boehm: No, I have the application. I have things that you could get from the US patent office—that I could get from the US patent office. I have very few notes. I do have some scribbled Ray Joao's notes, but I think you gave me those notes.

Utley: I did. I gave you Bill Dick after Bill yourself[] the notes that I had.

Bernstein: And Ray's made disclosures to us that he destroyed the documents to protect us, which I don't know what he was thinking.

2

Simon Bernstein: Destroyed what documents?

Bernstein: Whatever he had in his files. Other patent copies, copies of the drafts as they proceeded...all that he destroyed to protect us from something I asked him to explain, and his reasoning...because I said to him, you know, usually you destroy documents when you are protecting somebody from something illegal or something. Have I done something that would force you to hurt me possibly? He said it was typical, normal, that all lawyers destroy their records.

⁵³ Footnote transcription...



Simon Bernstein: If that, in fact, is the case—I've never heard of a lawyer you know other than Nixon destroying anything the work is ours. Am I right Chris when we pay for a lawyer and we pay for the work, the work is ours.

Wheeler: The work product is yours. He may maintain copies of his files and everything; or his confidential notes to himself are not necessarily yours. But the work "product" is...

Simon Bernstein: Would you say that anything germane to the issue belongs to him?

Wheeler: Well, I mean if he wrote notes...in sidebars...yeah.

Bernstein: How about revised patents[]. How about copies? Works in progress

Wheeler: But things which would reinforce your patent, obviously, that is germane to the strength of your patent yes, you would be entitled to copies I don't think we disagree.

Bernstein: He's claiming He destroyed all faxes.



EXHIBIT Q

IN THE CIRCUIT COURT OF THE
15TH JUDICIAL CIRCUIT IN AND
FOR PALM BEACH COUNTY,
FLORIDA

PROSKAUER ROSE L.L.P.,
a New York limited partnership,

CA 01-04671 AB

Plaintiff,

v.

IVIEWIT.COM, INC., a Delaware
corporation, IVIEWIT HOLDINGS,
INC., a Delaware corporation, and
IVIEWIT TECHNOLOGIES, INC.,
a Delaware corporation.

Defendants.

COPY / ORIGINAL
RECEIVED FOR FILING

JAN 28 2003

DOROTHY H. WILKEN
CLERK OF CIRCUIT COURT
CIRCUIT CIVIL DIVISION

**DEFENDANTS MOTION FOR LEAVE TO AMEND TO ASSERT
COUNTERCLAIM FOR DAMAGES**

Defendants, IVIEWIT.COM, INC., IVIEWIT HOLDINGS,
INC. and IVIEWIT TECHNOLOGIES, INC., by and through their undersigned
counsel, hereby move this Court for Leave to Amend their Answer so as to assert a
counterclaim in this matter pursuant to Rule 1.170(f) of the Florida Rules of Civil
Procedure and as grounds therefore would state as follows:

1. That the Defendants move to amend their answer in this matter so as to
include a counterclaim in this matter, which by its nature appears to be a compulsory
counterclaim to the extent that the issues arise out of the same nexus of events, as

justice requires that the counterclaim be tried at the same time as the complaint and answer so that all pending issues between the parties may be adjudicated in this action.

2. That as a result of fact that additional evidence in support of the Defendants' counterclaims is found in the Plaintiff's own files and records, the Plaintiff will not be prejudiced by the amendment of the Defendants' answer in this matter, nor will this matter be delayed as to the trial of same.

3. Defendants have attached hereto a copy of the proposed counterclaim.

WHEREFORE the Defendants, move this Honorable Court for the entry of an order permitting the Defendants to amend their answer in this matter.

I HEREBY CERTIFY that a true and correct copy of the foregoing has been provided by U.S. Mail and fax transmission this 20th day of January, 2003 to: Christopher W. Prusaski, Esq., Proskauer Rose, LLP, 2255 Glades Road, Suite 340 W, Boca Raton, FL 33431.

SELZ & MUVDI SELZ, P.A.
214 Brazilian Avenue, Suite 220
Palm Beach, FL 33480
Tel: (561) 820-9409
Fax: (561) 833-9715

By: 
STEVEN M. SELZ
FBN: 777420

IN THE CIRCUIT COURT OF THE
15th JUDICIAL CIRCUIT IN AND
FOR PALM BEACH COUNTY,
FLORIDA

PROSKAUER ROSE, LLP, a New York
limited partnership,

CASE NO.: CA 01-04671 AB

Plaintiff,

vs.

IVIEWIT.COM, INC., a Delaware
corporation, IVIEWIT HOLDINGS,
INC., a Delaware corporation and,
IVIEWIT TECHNOLOGIES, INC.,
a Delaware corporation,

Defendants,

COUNTERCLAIM FOR DAMAGES

COME NOW the Counter Plaintiffs, IVIEWIT.COM, INC., IVIEWIT
HOLDINGS, INC., IVIEWIT TECHNOLOGIES, INC. and IVIEWIT LLC,
hereinafter collectively referred to as "IVIEWIT" or Counter Plaintiffs, and hereby
sues Counter Defendant, PROSKAUER ROSE, LLP, hereinafter "PROSKAUER",
a New York limited partnership, and alleges as follows:

GENERAL ALLEGATIONS COMMON TO ALL COUNTS

1. This is an action for damages in a sum greater than \$15,000.00, exclusive

of interest, taxable costs and attorneys fees.

2. Counter Plaintiff, IVIEWIT.COM, INC., is a Delaware corporation, formed by PROSKAUER, which at all times relevant hereto was authorized to conduct and conducted business in Palm Beach County Florida and the State of California.

3. Counter Plaintiff, IVIEWIT HOLDINGS, INC., is a Delaware corporation, formed by PROSKAUER, which at all times relevant hereto was authorized to conduct and conducted business in Palm Beach County Florida and California.

4. Counter Plaintiff, IVIEWIT TECHNOLOGIES, INC., is a Delaware corporation, formed by PROSKAUER, which at all times relevant hereto was authorized to conduct and conducted business in Palm Beach County Florida and the State of California.

5. IVIEWIT LLC, is a Florida limited liability company, formed by PROSKAUER, which, at all times relevant hereto, was authorized to conduct and conducted business in the Palm Beach County Florida and the State of California.

6. Counter Defendant PROSKAUER ROSE, LLP, (hereinafter "PROSKAUER") is a New York limited partnership, operating a law office in Boca Raton, Palm Beach County, Florida.

Boca Raton, Palm Beach County, Florida.

7. BRIAN G. UTLEY, (hereinafter "UTLEY") was at all times relevant hereto a sui juris resident of the State of Florida and who on or about September of 1999 was the president of Counter Plaintiff, IVIEWIT LLC.

8. CHRISTOPHER WHEELER, (hereinafter "WHEELER") is a sui juris individual and resident of Palm Beach County, Florida, who at all times relevant hereto was a partner of PROSKAUER and who provided legal services to the Counter Plaintiffs.

9. KENNETH RUBENSTEIN, (hereinafter "RUBENSTEIN") is a sui juris individual believed to be a resident of the State of New York and who various times relevant hereto was initially misrepresented by WHEELER as a partner of PROSKAUER and later became a partner of PROSKAUER, and who provided legal services to the Counter Plaintiffs both while at Meltzer, Lippie, et al., and PROSKAUER.

10. RAYMOND JOAO, (hereinafter "JOAO") is a sui juris individual believed to be a resident of the State of New York and who at all times relevant hereto was represented to be RUBENSTEIN's associate at PROSKAUER, when in fact JOAO has never been an employee of PROSKAUER but in fact was an employee of Meltzer, Lippie, et al.

11. That beginning on or about November of 1998, the Counter Plaintiff, IVIEWIT, through it's agent and principal, Eliot I. Bernstein ("Bernstein"), held discussions with WHEELER with regard to PROSKAUER providing legal services to the company involving specific technologies developed by Bernstein and two others, which technologies allowed for:

i) Zooming of digital images and video without degradation to the quality of the digital image due to what is commonly referred to as "pixilation";
and,

ii) The delivery of digital video using proprietary scaling techniques;
and,

iii) A combination of the image zoom techniques and video scaling techniques described above; and,

iv) The remote control of video cameras through communications networks.

12. That Bernstein engaged the services of PROSKAUER to provide legal services to the company to be formed, including corporate formation and governance for a single entity and to obtain multiple patents and oversee US and foreign filings for such technologies including the provisional filings for the technologies as described in Paragraph 11 above, the "Technology", and such

other activities as were necessary to protect the intellectual property represented by the Technology.

13. That at the time of the engagement of PROSKAUER, Bernstein was advised and otherwise led to believe that WHEELER was the PROSKAUER partner in charge of the account.

14. Upon information and belief, WHEELER, RUBENSTEIN and JOAO upon viewing the technologies developed by Bernstein, and held by IVIEWIT, realized the significance of the technologies, its various applications to communication networks for distributing video data and images and for existing digital processes, including, but not limited to digital cameras, digital video disks (DVD), digital imaging technologies for medical purposes and digital video, and that WHEELER, RUBENSTEIN and JOAO conspired to undertake and in fact undertook a deliberate course of conduct to deprive Bernstein and IVIEWIT of the beneficial use of such technologies for either the use of third parties, who were other clients of PROSKAUER and WHEELER, or for WHEELER, RUBENSTEIN and JOAO's own financial gain, to the detriment and damage of the Counter Plaintiffs.

15. That WHEELER, who was a close personal friend of UTLEY, recommended to Bernstein and other members of the board of directors of

IVIEWIT that the IVIEWIT engage the services of UTLEY to act as President of the Iviewit.com, LLC based on his knowledge and ability as to technology issues.

16. That at the time that WHEELER made the recommendation of UTLEY to the board of directors, that WHEELER knew that UTLEY was in a dispute with his former employer, Diamond Turf Products and the fact that UTLEY had misappropriated certain patents on hydro-mechanical systems to the detriment of Diamond Turf Products.

17. Additionally, WHEELER was fully aware of the fact that UTLEY was not the highly qualified "engineer" that UTLEY represented himself to be, and that in fact UTLEY lacked real engineering expertise or even an engineering degree and that UTLEY had been fired from Diamond Turf Products due to his misappropriation of patents.

18. That despite such knowledge, WHEELER never mentioned such facts concerning UTLEY to any representative of IVIEWIT and in fact undertook to "sell" UTLEY as a highly qualified candidate who would be the ideal person to undertake day to day operations of IVIEWIT and work on the patents, acting as a qualified engineer.

19. Additionally, WHEELER continued to assist UTLEY in perpetrating such fraud on both the Board of Directors of IVIEWIT and to third parties,

including Wachovia Bank, by approving a false resume for UTLEY to be included in seeking approval of a private placement for IVIEWIT.

20. That based on the recommendations of WHEELER, as partner of PROSKAUER, the board of directors agreed to engage the services of UTLEY as president.

21. That almost immediately after UTLEY's employment and almost one year after initially providing of services, WHEELER provided a retainer agreement for the providing of services by PROSKAUER to IVIEWIT LLC, addressed to UTLEY, a true and correct copy of such retainer agreement (the "Retainer") being attached hereto and made a part hereof as Exhibit "A". That the services provided were in fact to be paid out of the royalties recovered from the use of the Technology, which was to be included in patent pools overseen by RUBENSTEIN.

22. That the Retainer by its terms contemplated the providing of corporate and general legal services to IVIEWIT LLC by PROSKAUER and was endorsed by UTLEY on behalf of IVIEWIT LLC, the Board of Directors of IVIEWIT LLC would not have UTLEY authorized to endorse same as it did not include the intellectual property work which PROSKAUER had already undertaken.

23. That prior to the Retainer, PROSKAUER and WHEELER had provided

legal services to IVIEWIT, including services regarding patent procurement and acted to coordinate such services both internally and with outside counsel, including RUBENSTEIN and JOAO, including times when they were misrepresented as PROSKAUER attorneys.

24. That PROSKAUER billed IVIEWIT for legal services related to corporate, patent, trademark and other work in a sum of approximately \$800,000.00.

25. That PROSKAUER billed IVIEWIT for legal service never performed, double-billed by the use of multiple counsel on the same issue, and systematically overcharged for services provided.

26. That summaries of the billing statements provided by PROSKAUER to IVIEWIT are attached hereto and made a part hereof as Exhibit "B".

27. That based on the over-billing by PROSKAUER, IVIEWIT paid a sum in of approximately \$500,000.00 plus together with a 2.5% interest in IVIEWIT, which sums and interest in IVIEWIT was received and accepted by PROSKAUER.

28. That WHEELER, UTLEY, RUBENSTEIN, JOAO and PROSKAUER, conspired to deprive IVIEWIT of its rights to the technologies developed by Bernstein by:

a) Transferring patents using Foley & Lardner so as to name UTLEY as the sole holder of multiple patents in his individual name and capacity when in fact they were and arose from the technologies developed by Bernstein and others and held by IVIEWIT prior to UTLEY's employment with IVIEWIT, and;

b) Upon discovery of the "lapses" by JOAO, that WHEELER and PROSKAUER referred the patent matters to WILLIAM DICK, of Foley & Lardner, who was also a close personal friend of UTLEY and who had been involved in the diversion of patents to UTLEY at Diamond Turf Products; and,

c) Failing to list proper inventors of the technologies based on improper legal advise that foreign inventors could not be listed until their immigration status was adjusted, resulting in the failure of the patents to include their rightful and lawful inventors and the payment by IVIEWIT for unnecessary immigration work; and,

d) Failing to ensure that the patent applications for the technologies, contained all necessary and pertinent information relevant to the technologies and as required by law; and,

e) Failing to secure trademarks and copyrights and failing to complete trademark and copyright work for the use of proprietary names of IVIEWIT and source code for the Technologies of IVIEWIT as intellectual property, and;

f) Allowing the infringement of patent rights of IVEIWIT and the intellectual property of IVIEWIT by other clients of PROSKAUER and WHEELER, and;

g) Aiding JOAO in filing patents for IVIEWIT intellectual property by intentionally withholding pertinent information from such patents and not filing same timely, so as to allow JOAO to apply for similar patents in his own name, both while acting as counsel for IVIEWIT and subsequently.

29. As a direct and proximate result of the actions of the Counter Defendant, Counter Plaintiffs have been damaged in a sum estimated to be greater than \$10,000,000,000.00, based on projections by Gerald Stanley, CEO of Real 3-D (a consortium of Lockheed, Silicone Graphics and Intel) as to the value of the technologies and their applications to current and future uses together with the loss of funding from Crossbow Ventures as a result of such conduct.

30. All conditions precedent to the bringing of this action have occurred or have been waived or excused.

COUNT I- LEGAL MALPRACTICE

31. This is an action for legal malpractice within the jurisdiction of this court.

32. Counter Plaintiff re-alleges and hereby incorporates that allegations of Paragraphs 1 through 30 as if fully set forth herein.

33. PROSKAUER employed by IVIEWIT for purposes of representing IVIEWIT to obtain multiple patents and oversee foreign filings for such technologies including the provisional filings for the technologies as described in Paragraph 11 above.

34. That pursuant to such employment, PROSKAUER owed a duty to ensure that the rights and interests of IVIEWIT were protected.

35. WHEELER, RUBENSTEIN, JOAO and PROSKAUER neglected that reasonable duty of care in the performance of legal services in that they:

a) Failed to take reasonable steps to ensure that the intellectual property of IVIEWIT was protected; and,

b) Failed to complete work regarding copyrights and trademarks; and,

c) Engaged in unnecessary and duplicate corporate and other work resulting in billing for unnecessary legal services believed to be in excess of \$400,000.00; and,

d) By redacting information from the billing statements regarding services provided so to as to give the appearance that the services provided by PROSKAUER were limited in nature, when in fact they involved various aspects of intellectual property protection; and,

e) By knowingly representing and agreeing to accept representation of

clients in conflict with the interests of IVIEWIT, without either consent or waiver by IVIEWIT.

36. That the negligent actions of PROSKAUER and its partners, WHEELER and RUBENSTEIN, resulted in and was the proximate cause of loss to IVIEWIT.

WHEREFORE, Counter Plaintiff demands judgement for damages against Defendant together with reasonable attorneys fees, court costs, interest and such other and further relief as this Court deems just and equitable.

COUNT II- CIVIL CONSPIRACY

37. This is an action for civil conspiracy within the jurisdiction of this court.

38. Counter Plaintiff re-alleges and hereby incorporates that allegations of Paragraphs 1 through 30 as if fully set forth herein.

39. Defendant, PROSKAUER and UTLEY, WHEELER, RUBENSTEIN and JOAO, jointly conspired to deprive the Counter Plaintiffs of their rights and interest in the Technology.

40. That UTLEY, WHEELER, RUBENSTEIN, JOAO and PROSKAUER with such intent, directed that certain patent rights be put in the name of UTLEY and/or that such patent rights were modified or negligently pursued so as to fail to provide protection of the intellectual property, resulting in the ability of other clients of WHEELER, RUBENSTEIN, JOAO and PROSKAUER to make use of such

technologies without being liable to IVIEWIT for royalties normally arising from such use.

41. That PROSKAUER, without either consent of the Board of Directors or proper documentation, transferred securities to Tiedemann/Prolow Investment Group, which entity was also referred by WHEELER, who acted as counsel for such unauthorized transaction.

42. That upon the discovery of the above-described events and conspiracy, IVIEWIT's lead investor, Crossbow Ventures, ceased its funding of IVIEWIT.

43. That Crossbow Ventures, which was a referral of WHEELER, took a security interest in the Technology under the guise of protecting IVIEWIT and its shareholders from the actions of UTLEY, based on the filing of an involuntary bankruptcy (which was later withdrawn), and as to WHEELER and PROSKAUER based on the instant law suit, when in fact such conduct was motivated by Crossbow's attempts to wrongfully detain the interests of IVIEWIT in the Technology. Such conduct, upon information and belief, was undertaken with the knowledge and assistance of WHEELER and PROSKAUER.

44. As a direct and proximate result of the conspiracy and acts of PROSKAUER, UTLEY, WHEELER, JOAO and RUBENSTEIN, the Counter Plaintiffs have been damaged.

WHEREFORE, Counter Plaintiffs demand judgement for damages against Defendant together with court costs, interest and such other and further relief as this Court deems just and equitable.

COUNT III- BREACH OF CONTRACT

45. This is an action for breach of contract within the jurisdiction of this Court.

46. Counter Plaintiff re-alleges and hereby incorporates that allegations of Paragraphs 1 through 30 as if fully set forth herein.

47. Defendant, PROSKAUER, breached the contract with Counter Plaintiff, IVIEWIT LLC by failing to provide services billed for pursuant to the billing statements presented to the Counter Plaintiffs and over-billing for services provided.

48. That such actions on the part of PROSKAUER constitute beaches of the contract by and between IVIEWIT LLC and PROSKAUER.

49. That as a direct and proximate result of such conduct on the part of PROSKAUER, IVIEWIT LLC has been damaged by overpayment to PROSKAUER and the failure of PROSKAUER to perform the contracted for legal services.

WHEREFORE, IVIEWIT demands judgement for damages against Counter Defendant together with court costs, interest and such other and further relief as this Court deems just and equitable.

**COUNT IV- TORTIOUS INTERFERENCE WITH AN ADVANTAGEOUS
BUSINESS RELATIONSHIP**

50. This is an action for tortious interference with an advantageous business relationship within the jurisdiction of this Court.

51. Counter Plaintiff re-alleges and hereby incorporates that allegations of Paragraphs 1 through 30 as if fully set forth herein.

52. Counter Plaintiff was engaged in negotiations of technology agreements with both Warner Bros. and AOL/Time Warner as to the possible use of the Technologies of the Counter Plaintiffs and investment in Counter Plaintiffs as a strategic partner.

53. That despite the prior representations of RUBENSTEIN, at a meeting held on or about November 1, 2000, by and between UTLEY, RUBENSTEIN and representatives of Warner Bros. as to the Technology of IVIEWIT and the efficacy, novelty and unique methodology of the Technology, RUBENSTEIN refused to subsequently make the same statements to representatives of AOL and Warner Bros., taking the position that since Warner Bros./AOL is "now a big client of Proskauer, I can't comment on the technologies of Iviewit." or words to that effect in response to inquiry from Warner Brother/AOL's counsel as to the status and condition of the pending patents on the intellectual property.

54. That RUBENSTEIN, having served as an advisor to the Board of Directors for IVIEWIT, was aware of the fact that at the time of the making of the statements set forth in Paragraph 50, above, IVIEWIT was in the midst of negotiations with AOL/Warner Bros. as to the possible funding of the operations of IVIEWIT in and sum of between \$10,000,000.00 and \$20,000,000.00.

55. Further, RUBENSTEIN as a partner of PROSKAUER, and despite his clear prior actions in representing the interests of IVIEWIT, refused to answer questions as to the enforcement of the Technology of IVIEWIT, with the intent and knowledge that such refusal would lead to the cessation of the business relationship by and between IVIEWIT and Warner Bros./AOL and other clients familiar with the Warner Bros./AOL technology group then in negotiations with IVIEWIT, including, but not limited to Sony Corporation, Paramount, MGM and Fox.

56. That the actions of RUBENSTEIN were and constituted an intentional and unjustified interference with the relationship by and between IVIEWIT and Warner Bros./AOL designed to harm such relationship and further motivated by the attempts to "cover-up" the conflict of interest in PROSKAUER's representation of both IVIEWIT and Warner Bros./AOL.

57. That indeed, as a direct and proximate result of the conduct of RUBENSTEIN, Warner Bros./AOL ceased business relations with IVIEWIT to the

damage and detriment of Counter Plaintiffs.

WHEREFORE, Counter Plaintiffs demand judgement for damages against Counter Defendant together with court costs, interest and such other and further relief as this Court deems just and equitable.

I HEREBY CERTIFY that a true and correct copy of the foregoing has been provided by U.S. Mail and fax transmission this 20th day of January, 2003 to: Christopher W. Prusaski, Esq., Proskauer Rose, LLP, 2255 Glades Road, Suite 340 W, Boca Raton, FL 33431.

SELZ & MUVDI SELZ, P.A.
214 Brazilian Avenue, Suite 220
Palm Beach, FL 33480
Tel: (561) 820-9409
Fax: (561) 833-9715

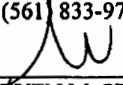
By: 

STÉVEN M. SELZ
FBN: 777420



EXHIBIT R



COMPANY REVENUE PROJECTIONS

Calculated Discount Rate:	12.00%				
	Year 1	Year 2	Year 3	Year 4	Year 5
Revenue Potential					
<i>Device OEM Licensing</i>	\$387,491,845	\$410,385,714	\$435,344,087	\$485,758,798	\$543,018,985
<i>Motion Picture Video on Demand ("VOD") Licensing</i>	4,260,793	4,778,426	5,648,251	7,151,662	9,707,205
<i>DVD Encoding/Replication</i>	383,471,325	430,058,359	508,342,628	643,649,599	873,648,447
<i>Appliances (copiers, printers, etc.)</i>	290,618,884	307,789,285	326,908,066	364,319,098	407,264,239
<i>Other Device OEM's (scanners, game boxes, e-books, etc.)</i>	96,872,961	102,596,428	108,836,022	121,439,699	135,754,746
<i>Delivery Systems (terrestrial, ISP, Wireless, etc.)</i>	387,491,845	0	0	0	0
<i>Medical Imaging and Devices</i>	116,247,554	123,115,714	130,603,226	145,727,639	162,905,696
<i>Wireless Devices</i>	271,244,292	287,270,000	304,740,861	340,031,159	380,113,290
<i>Enterprise Software</i>	191,735,663	215,029,179	254,171,314	321,824,799	436,824,224
<i>Internet (auctions, retail games, etc.)</i>	<u>191,735,663</u>	<u>215,029,179</u>	<u>254,171,314</u>	<u>321,824,799</u>	<u>436,824,224</u>
Present Value -- Total Revenue Potential	1,875,454,356	1,670,960,048	1,657,584,195	1,749,351,147	1,921,901,867
Present Value -- Cumulative Revenue Potential	<u>1,875,454,356</u>	<u>3,546,414,404</u>	<u>5,203,998,599</u>	<u>6,953,349,746</u>	<u>8,875,251,614</u>
Present Value -- Cum. Rev. Pot. Over 20-Year Patent Life	<u>\$17,353,552,076</u>				
Assume Percentage of Unsuccessful U.S. Patent Repair	\$6,802,592,414				
Assume Percentage of Forfeiting PCT Protection	<u>3,470,710,415</u>				
Cum. Potential Damages Over 20-Year Patent Life	<u>\$10,273,302,829</u>				



EXHIBIT S



Typical Video

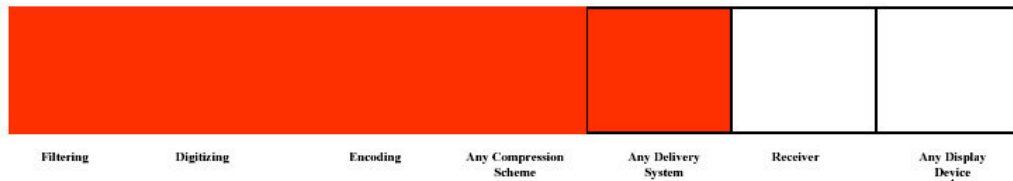
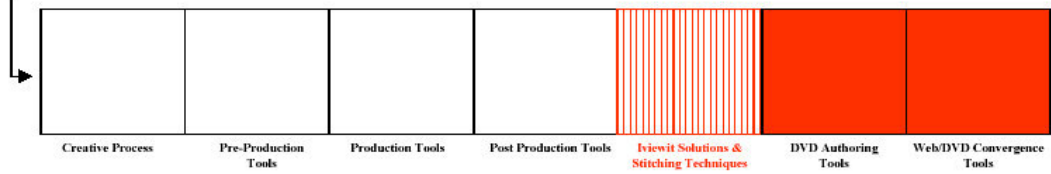

Key:  Better Enabled by Essential Iviewit Technology

- HDTV
- DTV
- Cable STB
- Satellite STB
- ADC STB
- DVD Players
- Digital Cameras/Camcorders
- PC

Proprietary & Confidential



MPEG 2 LICENSORS

ALCATEL

BOSCH

Canon

COLUMBIA UNIVERSITY

 **france telecom**

FUJITSU



We bring good things to life.

GI General Instrument[®]

HITACHI

JVC



**Philips
Electronics**



**Sharp
Corporation**

SONY



TOSHIBA



MPEG 2 LICENSEES

1. AAV Australia Pty Ltd
2. Access Media S.P.A.
3. Action Electronics Co., Ltd.
4. Action Industries (M) SDN. BHD.
5. Acoustic Systems, Inc.
6. ADI Corporation
7. Adspace Networks, Inc.
8. AEON Digital Corp
9. Aeroflex Lintek, Inc.
10. AgileTV Corporation
11. Ahead Software AG
12. Ahead Software Incorporated
13. Airshow, Inc.
14. Aiwa Co., Ltd.
15. Alcatel
16. Alco Digital Devices Limited
17. Alcorn McBride, Inc.
18. Alpine Electronics, Inc.
19. AMLOGIC, Inc.
20. Amnis Systems Inc.
21. Amphion Semiconductor (Asia) Limited
22. Amphion Semiconductor Inc.
23. Amphion Semiconductor Limited
24. Amstrad plc
25. AnalyTotal Ltd.
26. Apex Digital, Inc.
27. Aplus Technics Co., Ltd.
28. Apollo Electronics Group Limited
29. Apple Computer, Inc.
30. A&R Cambridge Limited
31. ASC Audio Video Corporation
32. ASE Technologies, Inc.
33. Astrodesign, Inc.
34. ATL Electronics (M) Sdn. Bhd.
35. ATL Hong Kong Limited
36. ATLM Taiwan Inc.
37. Audiovox Electronics Corporation
38. Axis Communications AB
39. Bang & Olufsen A/S
40. BarcoNet n.v.
41. Bashaw, Sean
42. Beautiful Enterprise Co., Ltd
43. BennArts
44. B.H.A. Corporation
45. Billionton Systems Inc.
46. BitCtrl Systems GmbH
47. Blonder Tongue Laboratories, Inc.



48. Bose Corporation
49. Broadcast Sports Inc.
50. Broadcast Technology Limited
51. B.U.G., Inc.
52. Canon Inc.
53. Casio Computer Co., Ltd.
54. C-Cube Microsystems, Inc.
55. CD Linja, Digital Communication Media Oy
56. CellStack Systems Ltd
57. CenDyne, Inc.
58. Cequadrat (USA), Inc.
59. CGI Verwaltungsgesellschaft mbH
60. Cheertek Inc.
61. Chumiecki, Tomasz J.
62. Cine Magnetics Video & Digital Laboratories
63. Cinram France, S.A.
64. Cinram Inc.
65. Cinram International Inc.
66. Cinram Latinoamericana S.A. de C.V.
67. Cinram Nederland B.V.
68. Cinram Optical Discs, S.A.
69. Cinram U.K. Ltd.
70. Cirrus Logic Inc.
71. CIS Technology Inc.
72. Cisco Australia
73. Cisco Canada
74. Cisco Japan
75. Cisco Systems BV and Cisco Systems Capital BV
76. Cisco Systems Capital
77. Cisco Systems, Inc.
78. Clarion Co., Ltd.
79. Codex Novus, Inc.
80. Columbia Digital Media, Inc.
81. Compaq Computer Corporation
82. Computer Modules, Inc.
83. Cornet Technology, Inc.
84. Coull Limited
85. Custom Technology Corporation
86. CyberLink Corp.
87. Cyrus Electronics Ltd.
88. Daewoo Electronics Corporation
89. Dai Hwa Industrial Co., Ltd.
90. Darim Vision Co.
91. Data Becker GmbH & Co. KG
92. Dataton Utvecklings AB
93. DCM Danmark, Digital Communication Media Aps
94. DCM Sweden, Digital Communication Media AB
95. DCM TriData, Digital Communication Media AB
96. DEFINITION Consultants Ltd.
97. Delco Electronics Corporation
98. DELL Products, L.P.
99. Denon Digital Industries
100. Denon Electronic GmbH
101. DENON, Ltd.
102. Digatron Industrie-Elektronik



103. DigiOn, Inc.
104. Digital Audio Disc Corporation
105. Digital Communication Media AB
106. Digital Media Technologies, Ltd.
107. Digital Transmission Equipment
108. Digital Video Services
109. Digital Vision AB
110. Digitalfabriken Göteborg, Digital Communication Media AB
111. Diotech SMT Product Co., Ltd.
112. Direct Broadcasting Satellite Corporation
113. DirectSat Corporation
114. Disctronics Manufacturing (UK) Limited
115. Dish Entertainment Corporation
116. Dish Factory Direct Corporation
117. Dish, Ltd.
118. DIVA Systems Corporation
119. DivXNetworks, Inc. (DIVX)
120. Doremi Labs, Inc.
121. Drastic Technologies Ltd.
122. DResearch Digital Media Systems GmbH
123. D.S. Corporation
124. DVD Retail Ltd. (Mirror)
125. DX Antenna Co., Ltd.
126. Eastern Asia Technology Limited
127. Eastwin Technology Inc
128. Eastwin Technology Industries (Hui Yang) Co. Ltd.
129. Easy Systems Japan Ltd.
130. Echonet Business Network, Inc.
131. Echosphere Corporation
132. Echosphere De Mexico S.De R.L. De. C.V.
133. EchoStar Acceptance Corporation
134. EchoStar Communications Corporation
135. EchoStar DBS Corporation
136. EchoStar Indonesia Corporation
137. EchoStar International Corporation
138. EchoStar International (Maritius Limited)
139. EchoStar KuX Corporation
140. EchoStar Manufacturing and Distribution Private Limited (India)
141. EchoStar North America Corporation
142. EchoStar PAC Corporation
143. EchoStar Real Estate Corporation
144. EchoStar Real Estate Corporation II
145. EchoStar Satellite Broadcasting Corporation
146. EchoStar Satellite Corporation
147. EchoStar Space Corporation
148. EchoStar Technology, Inc.
149. ECM Systems Ltd.
150. EG Technology, Inc.
151. ek3 Technologies Inc.
152. Elma Ingénierie Informatique



153. EMI Global, Inc.
154. EMI Operations Italy S.p.A.
155. EMI Recorded Music
156. Enlight Corporation
157. Enseo, Inc.
158. ERDAS, Inc.
159. E-Sat, Inc.
160. E-Soft Computer Co., Ltd.
161. ESBuy.com
162. ESDG Konsult AB
163. Etronics Corporation
164. EuroNimbus S.A.
165. Exatel Visual Systems, Inc.
166. FineArch Inc.
167. First Virtual Communications, Inc.
168. Flextracker Sdn. Bhd.
169. Formation, Inc.
170. Frey Technologies, LLC
171. Fujitsu Limited
172. Fujitsu Siemens Computers
173. Fujitsu Siemens Computers AB
174. Fujitsu Siemens Computers AG
175. Fujitsu Siemens Computers AS
176. Fujitsu Siemens Computers A/S
177. Fujitsu Siemens Computers BV
178. Fujitsu Siemens Computers d.d.
179. Fujitsu Siemens Computers GmbH
180. Fujitsu Siemens Computers KFT
181. Fujitsu Siemens Computers Ltd
182. Fujitsu Siemens Computers Oy
183. Fujitsu Siemens Computers (Pty)
Ltd
184. Fujitsu Siemens Computers s.r.o.
185. Fujitsu Siemens Computers SA
186. Fujitsu Siemens Computers SL
187. Fujitsu Siemens Computers SP.
z.o.o.
188. Fujitsu Siemens Computers SpA
189. FUJITSU TEN LIMITED
190. Funai Electric Co., Ltd.
191. Fusic Electronics Ltd
192. Gateway, Inc.
193. GBM Advanced Technology
International Inc.
194. General Instrument Corporation
195. Generic Media Inc.
196. Global Web TV, Inc.
197. GPX, Inc.
198. Grass Valley (US) Inc.
199. Great Wall Digitech Limited
200. GRUNDIG AG
201. Gyro Media AB
202. Gyro Soft AB
203. Harman International Industries
204. Harmonic Inc.
205. Heim Systems GmbH
206. Heuris Logic Incorporated
207. Hewlett-Packard Company
208. Hibino Data-com Co., Ltd.
209. High Speed Video Inc.
210. Hitachi Business Solutions Co., Ltd.
211. Hitachi Communication Systems,



212. Hitachi Electronics Engineering Co., Ltd.
213. Hitachi Electronics Products (Malaysia) Sdn. Bhd.
214. Hitachi Engineering Co., Ltd.
215. Hitachi Home Electronics (America), Inc.
216. Hitachi Home Electronics (Europe), Ltd.
217. Hitachi Hometec, Ltd.
218. Hitachi Information Systems, Ltd.
219. Hitachi Kokusai Electric Inc.
220. Hitachi, Ltd.
221. Hitachi SK Social System Co., Ltd.
222. Hitachi Software Engineering America, Ltd.
223. Hitachi Software Engineering Co., Ltd.
224. Hitachi Software Engineering Europe S.A.
225. Hitachi Software Global Technology, Ltd.
226. Hitachi Technology (Taiwan) Ltd.
227. Hitachi Telecom Technologies, Ltd.
228. Hong Kong Tohei E.M.C. Co., Ltd.
229. Houston Tracker Systems, Inc.
230. HT Ventures, Inc.
231. Hughes Network Systems
232. Hui Yang Eastway Electronics Co., Ltd
233. HUMAX Co., Ltd.
234. HUMAX Electronic Ltd.
235. Hyunwoo McPlus Co., Ltd.
236. IBE, Inc.
237. Ikegami Tsushinki Co., Ltd.
238. Imedia Corporation
239. iMPath Networks, Inc.
240. Independent Masters Ltd.
241. Indoor Outdoor Entertainment, S.A.
242. Innobits AB
243. Innovision Limited
244. Institut fuer Rundfunktechnik GmbH
245. International Antex, Inc.
246. International Fiber Systems, Inc.
247. International Image Services Corp. doing business as Sonic Foundry Media Services
248. International PADI, Inc.
249. Interra Digital Video Technologies
250. InterVideo, Inc.
251. Inventec Electronics (M) Sdn. Bhd.
252. iZotope, Inc.
253. Japan Communication Equipment Co., Ltd.
254. Japan Digital Laboratory Co., Ltd.
255. Japan Radio Co., Ltd.
256. Japan Wave Inc.
257. Jaton Computer Co., Ltd.



258. JEPRO Co., Ltd.
259. J Hepple, Incorporated
260. Jin Shen Long Electronics (Shen Zhen) Co., Ltd
261. Kabushikigaisya Fujiyadenki Seisakusyo
262. Kalyani Sharp India Limited
263. Kent World Co., Ltd
264. Kenway Technology Industries (Hui Yang) Co. Ltd.
265. Kenwood Corporation
266. Kinki General Service Co., Ltd.
267. Koninklijke Philips Electronics N.V.
268. Krell Industries, Inc.
269. KUME Electric Corporation
270. L-3 Communications Systems West
271. Lawrence Livermore National Laboratory
272. Leitch Europe Limited
273. Leitch Incorporated
274. Leitch Technology Corporation
275. Leitch Technology International Inc.
276. LG Electronics Inc.
277. LifeScience Media
278. Lindows.com, Inc.
279. Linear Systems Ltd.
280. Link Research Ltd.
281. Linn Products Limited
282. LOEWE OPTA GmbH
283. Logic Innovations, Inc.
284. Logitech Corporation
285. LOGOS Ljud och Bild Produktion AB
286. LSI Logic Corporation
287. LSI Systems Inc.
288. Lu Kee Electronic Company Limited
289. LuxSonor Semiconductors, Inc.
290. MacroSystem Digital Video AG
291. MacroSystem France S.A.S.
292. MacroSystem Schweiz AG
293. MacroSystem US, Inc.
294. Madrigal Audio Laboratories, Inc.
295. MainConcept GmbH
296. MainConcept LLC
297. MANSEI Corporation
298. Manufacturing and Test Co., Inc. dba MATCO
299. Manystreams, Inc.
300. Manzanita Systems
301. Marantz Japan, Inc.
302. Marconi Communications, Inc.
303. Mars Technologies, Inc.
304. Maspro Denkoh Corporation
305. Matsushita Electric Industrial Co., Ltd.
306. Matsushita Electric (Taiwan) Co., Ltd.
307. Matsushita Electric (U.K.) Ltd.
308. Matsushita Electronics Corporation
309. Matsushita-Kotobuki Electronics Industries, Ltd.
310. Matsushita Kotobuki Electronics



311. Matsushita Kotobuki Electronics Sales of America, LLC.
312. Matsushita Television and Network Systems Company, a division of Matsushita Electric Corporation of America
313. MAX Internet Communications, Inc.
314. MAXpc Technologies, Inc.
315. Media Compression LLC
316. MediaWare Solutions Pty Ltd.
317. MedioStream, Inc.
318. MELCO INC.
319. Memory-Tech Corporation
320. Meridian Audio Limited
321. Metatec International, Inc.
322. Metz-Werke GmbH & Co KG
323. MicronPC, LLC
324. Micron Government Computer Systems, LLC
325. Microtune (Texas), L.P.
326. MidStream Technologies, Inc.
327. Minerva Networks, Inc.
328. Mintek Digital Inc.
329. MIT Media Lab
330. Mitsubishi Electric Corporation
331. Mokoh & Associates, Inc.
332. Moonlight Cordless Ltd.
333. Motorola
334. MPO
335. MRT Technology LLC
336. Multimedia Technologies, Inc.
337. muvee Technologies Pte. Ltd.
338. NagraStar LLC
339. Namsung Corporation
340. Nanjing Sharp Electronics Co., Ltd.
341. National Semiconductor Corporation
342. NCR Corporation
343. NCT AG
344. NDS Limited
345. Neil Galton Consultancy Ltd
346. Neos Interactive Ltd.
347. NewSoft Technology Corporation
348. Next Level Communications, L.P.
349. NIHON COMPUTER Co., Ltd.
350. Nihon Digital Consumer Electronics Corporation
351. Nikko Denki Tsushin Corporation
352. Nimbus Manufacturing, Inc.
353. Nimbus Manufacturing (UK) Ltd.
354. Nokia Corporation by and through it's business unit
Nokia Home Communications
355. Norcent Technology Inc.
356. NTK Computer Inc.
357. NTT Advanced Technology Corporation
358. NTT Electronics Corporation
359. Nuon Semiconductor, Inc.
360. Oak Technology, Inc.



- 361. Oki Electric Industry Co., Ltd.
- 362. ONKYO CORPORATION
- 363. ONKYO ELECTRONICS CORPORATION
- 364. ONKYO EUROPE ELECTRONICS GmbH
- 365. ONKYO INDIA PVT. LTD
- 366. ONKYO (MALAYSIA) SDN. BHD
- 367. ONKYO U.S.A. CORPORATION
- 368. Optibase B.V.
- 369. Optibase Europe
- 370. Optibase Inc.
- 371. OPTIBASE LTD.
- 372. Optical Experts Manufacturing, Inc. (OEM)
- 373. Orion America, Inc.
- 374. Orion Electric Co., Ltd.
- 375. Orion Electric (U.K.) Ltd.
- 376. PAC Interactive Technology, Inc.
- 377. P. Guerra s.r.l.
- 378. Pace Micro Technology PLC
- 379. Panasonic AVC Networks Germany GmbH
- 380. Panasonic AVC Networks Singapore Pte Ltd
- 381. Panasonic Communications Co., Ltd.
- 382. Panasonic Digital Network Serve Inc.
- 383. Panasonic Disc Manufacturing Corporation of America
- 384. Panasonic Mobile Communications Co., Ltd.
- 385. Pegasys Inc.
- 386. Photodex Corporation
- 387. Pioneer Corporation
- 388. Pioneer Electronics Manufacturing (Shanghai) Co., Ltd.
- 389. Pioneer Electronics Technology (U.K.) Ltd.
- 390. Pioneer Technology (Malaysia) SDN, BHD
- 391. Pioneer Video Corporation
- 392. Pioneer Video Manufacturing Inc.
- 393. Plat'C2, Inc.
- 394. Popwire Stockholm AB
- 395. Pozzoli S.p.A
- 396. Private Eye Productions
- 397. Pro-G Group Inc.
- 398. Pro-G International Holdings
- 399. Proton Co., Ltd. Softboat Division Company
- 400. Provideo Multimedia Co. Ltd.
- 401. PT Matsushita Kotobuki Electronics Industries Indonesia
- 402. Pure Motion Ltd
- 403. Questin' Studios
- 404. Radyne ComStream
- 405. Regency Recordings Pty Ltd.
- 406. Research Systems, Inc.
- 407. Rohde & Schwarz GmbH & Co. KG
- 408. Roxio ApS



409. Roxio CI Ltd.
410. Roxio GmbH & Co. KG
411. Roxio, Inc.
412. Roxio International B.V.
413. Roxio Japan Inc.
414. S.A.D. GmbH
415. S. Anbu Ezhilan
416. Salent Technologies Ltd.
417. Sampo Corporation
418. Samsung Electronics Co., Ltd.
419. SANYO Electric Co., Ltd.
420. Sanyo Laser Products, Inc.
421. SANYO Manufacturing Corporation
422. SANYO Technosound Co., Ltd.
423. Sasken Communication Technologies Limited
424. Satellite Source, Inc.
425. Satrec Mauritius Limited
426. Scheidt & Bachmann GmbH
427. sci-worx GmbH
428. Science Applications International Corporation
429. Scientific-Atlanta, Inc.
430. Scopus Network Technologies Ltd.
431. sedima AG
432. Sensoray Company, Inc.
433. Sensory Science Corporation
434. Shanghai Far Year Technology Co., Ltd.
435. Sharp Corporation
436. Sharp Electronica Espana S.A
437. Sharp Electronica Mexico S.A. de C.V.
438. Sharp Manufacturing Company of America
439. Sharp Manufacturing Company of U.K.
440. Sharp Manufacturing Corporation (M) Sdn. Bhd.
441. Sharp-Roxy Appliances Corporation (M) Sdn. Bhd.
442. Sharp-Roxy Electronics Corporation (M) Sdn. Bhd.
443. Sharp Thebnakorn Manufacturing
444. Shenzhen Action Electronics Co., Ltd.
445. Shenzhen Kaixinda Electronics Co. Ltd.
446. Shenzhen Landel Electronics Tech. Co., Ltd.
447. Shin Won Industry Co., Ltd.
448. Shinsonic Multi-Media, Inc.
449. Silicon Construction Sweden AB
450. Simflex Software
451. SkyStream Networks Inc.
452. S.N.A. (Société Nouvelle Aréacem)
453. Snell & Wilcox Limited
454. Sonic Foundry, Inc.
455. Sonic Foundry Media Services, Inc.
456. Sonic Foundry Systems Group, Inc.
457. Sonic Solutions
458. Sonista, Inc.



459. Sonopress Iber-Memory, S.A.,
Spain
460. Sonopress, Inc., USA
461. Sonopress Ireland Limited
462. Sonopress Mexico Una division de
BMG Entertainment Mexico S.A. de
C.V.
463. Sonopress Pan Asia Ltd.
464. Sonopress Produktionsgesellschaft
für Ton-und Informationsträger
465. Sonopress Rimo Indústria e
Comércio Fonográfica Ltda
466. Sonopress Singapore PTE LTD
467. Sony Computer Entertainment Inc.
468. Sony Corporation
469. Sony DADC Austria AG
470. Sony Electronics Inc.
471. Sony Music Entertainment (Hong
Kong) Ltd.
472. Sony Music Entertainment (Japan)
Inc.
473. Sony Pictures Digital Inc.
474. Sony Service Center (Europe) NV
475. Sony United Kingdom, Ltd.
476. Sord Computer Corporation
477. Sorenson Media, Inc.
478. Spectaculaire!
479. Sports Training Media
480. S & T Systemtechnik GmbH
481. Standard Communications Corp.
482. Starlight Video Limited
483. Star Video Duplicating
484. Stebbing Recording Centre Ltd
485. Strategy & Technology Ltd.
486. Stream Machine Company
487. Sumitomo Electric Industries, Ltd.
488. Sunimage Studios Inc.
489. TAG McLaren Audio Limited
490. TAKT Kwiatkowski i Miadzel sp. j.
491. Tandberg Television ASA
492. Tatung Co.
493. TDK Electronics Corporation
494. TEAC Corporation
495. TEAC DEUTSCHLAND GmbH
496. TEAC SYSTEM CREATE
CORPORATION
497. Technicolor Disc Services
Corporation
498. Technicolor Home Entertainment
Services Ireland Ltd.
499. Technicolor Mexicana, S. de RL de
CV
500. Technicolor Pty Ltd.
501. Technicolor Videocassette, Inc.
502. TechniSat Digital GmbH
503. TechnoTrend AG
504. Techsan I&C Co., Ltd.
505. Tekniche Limited
506. Tektronix Cambridge Limited
507. Tektronix, Inc.
508. Telecom Kiki, Ltd.
509. Teledac Inc.



510. Teleview
511. Terr, LLC dba 321 Studios
512. The Mireth Technology Corporation
513. THOMSON
514. THOMSON Broadband UK Ltd.
515. THOMSON Digital Europe
516. THOMSON multimedia Asia Pacific Pte Ltd.
517. THOMSON multimedia Hong Kong Ltd.
518. THOMSON multimedia Inc.
519. THOMSON multimedia Operations (Thailand) Co. Ltd.
520. THOMSON multimedia Polska Sp. Z o.o.
521. THOMSON Sales Europe S.A.
522. THOMSON Television Angers S.A.
523. THOMSON TUBES & DISPLAYS S.A.
524. [Time Warner Inc.](#)
525. TiVo, Inc.
526. Tonic Digital Products Limited
527. Toppan Printing Co., Ltd.
528. Toshiba America Information Systems, Inc.
529. Toshiba Computer Systems (Shanghai) Co., Ltd.
530. Toshiba Corporation
531. Toshiba Europe GmbH
532. Toshiba Information Systems (UK) Limited
533. TOSHIBA TEC CORPORATION
534. TOSHIBA VIDEO PRODUCTS PTE LTD
535. Total Technology Co. Ltd.
536. TOTTORI ONKYO CORPORATION
537. Tottori SANYO Electric Co., Ltd.
538. Trilogic
539. Troll Technology Corporation
540. TTirem, Inc. dba Meritt Electronics
541. UEC Technologies (Pty) Ltd.
542. UnLimiter Limited
543. UP Technology Co., Ltd.
544. U.S. Philips Corporation
545. VBrick Systems, Inc.
546. VCS Video Communication Systems AG
547. Vela Research LP
548. Vestel Komunikasyon San. Tic. A. S.
549. Victor Company of Japan, Limited
550. VideoTele.com, Inc.
551. Visteon Corporation
552. VOB Computersysteme GmbH
553. V.T.V. NV
554. Welton Electronics Limited
555. Wescam Europe Limited
556. Wescam Inc.
557. Wescam Incorporated
558. Wescam LLC
559. Wescam Sonoma Inc.
560. Wiagra
561. Winbond Electronics Corp.



- 562. WIS Technologies, Inc.
- 563. Womble Multimedia, Inc.
- 564. World Electric (Thailand) Ltd.
- 565. Wuxi Multimedia Limited
- 566. Ya Bang Industrial Co., Ltd.
- 567. Yamaha Corporation
- 568. Yamaha Electronics Manufacturing (M) SDN.BDH.
- 569. Yanion Company Limited
- 570. Yung Fu Electrical Appliances Corp., Ltd.
- 571. Zapex Technologies, Inc.
- 572. ZapMedia.com, Inc.
- 573. Zenith Electronics Corporation
- 574. Zirbes, Kelly
- 575. ZOO Digital Group plc



EXHIBIT T



LETTER OF MR. WHEELER TO ROSSMAN

APR 26 1999 18:04 FR PROSKAUER ROSE

561 241 7145 TO 2410071#

P.02/02

PROSKAUER ROSE LLP

2255 Glades Road
Suite 340 West
Boca Raton, FL 33431-7360
Telephone 561.241.7400
Elsewhere in Florida
800.432.7746
Fax 561.241.7145

NEW YORK
LOS ANGELES
WASHINGTON
NEWARK
PARIS

Christopher C. Wheeler
Member of the Firm

Direct Dial 561.995.4702
cwheeler@proskauer.com

April 26, 1999

Mr. Richard Rosman
Lewinter and Rosman
16255 Ventura Blvd., Suite 600
Encino, CA 91436

Re: iviewit, Inc.

Dear Richard:

Under separate cover I have forwarded you a revised Confidentiality Agreement.

As you know we have undertaken representation of iviewit, Inc. ("iviewit") and are helping them coordinate their corporate and intellectual property matters. In that regard, we have reviewed their technology and procured patent counsel for them. We believe the iviewit technology is far superior to anything presently available with which we are familiar. iviewit has filed a provisional patent application on a method for providing enhanced digital images on telecommunications networks. We are advised by patent counsel that the process appears novel and may be protected by the patent laws. While in all matters of this sort, it is far too early to make any final pronouncements, we do believe that there is an extremely good prospect that iviewit will protect their process which is novel and superior to any other format which we have seen.

Very truly yours,

Christopher C. Wheeler

CCW/gb

0894/40017-001 BALIB1/227137 v1

04/22/99 03:57 PM (2743)



LETTER OF MR. WHEELER TO GEMAL SEEDE

JUN 10 1999 11:37 FR PROSKAUER ROSE

561 241 5288 TO 41744708

P.02/06

PROSKAUER ROSE LLP

2285 Glades Road
Suite 340 West
Boca Raton, FL 33431-7360
Telephone 561.241.7400
Elsewhere in Florida
800.432.7746
Fax 561.241.7145

NEW YORK
LOS ANGELES
WASHINGTON
MIAMI
PARIS

Christopher C. Wheeler
Member of the Firm
Direct Dial 561.995.4702
cwheeler@proskauer.com

June 9, 1999

Via Fax

Mr. Gemal Seede
Nercubator
30 W. Green Street
Pasadena, CA 91105

Dear Mr. Seede:

At the request of Alan Epstein, I am forwarding the enclosed two Confidentiality Agreements to you. I would appreciate your signing and returning them to me.

We have undertaken representation of iVIEWIT, Inc. ("iVIEWIT") and are helping them coordinate their corporate and intellectual property matters. In that regard, we have reviewed their technology and procured patent counsel for them. We believe the iVIEWIT technology is far superior to anything presently available with which we are familiar. iVIEWIT has filed a provisional patent application on a method for providing enhanced digital images on telecommunications networks. We are advised by patent counsel that the process appears novel and may be protected by the patent laws. While in all matters of this sort, it is far too early to make any final pronouncements. We do believe that there is an extremely good prospect that iVIEWIT will protect their process which is novel and superior to any other format which we have seen.

Sincerely,

Christopher C. Wheeler

CCW/gb

cc: Alan J. Epstein - Via Fax

0894/40017-001 BRUB1/232365 v1

06/09/99 08:52 PM 127431



DEPOSITION OF MR. WHEELER STATING RESPONDENT DID NO PATENT WORK

7 Q. How about Ken Rubenstein?
8 A. I don't believe Ken --
9 MR. TRIGGS: Object to form. What's your
10 question about Ken Rubenstein?
11 Q. Was he involved in the patent process or
12 any of the proceedings or services provided with
13 regard to the patents?
14 MR. TRIGGS: Object to the form.
15 A. No. He - he was -- First of all, I don't
16 believe he worked -- I believe he worked at Proskauer
17 at the time and not at Meltzer - Meltzer Lippy. Is
18 that the name of the firm? And secondly, he - his
19 involvement was only to -- He - he - he obviously is
20 a - one of our patent contacts and his - his --

ADMISSION BY MR. WHEELER OF CONSULTING WITH RESPONDENT⁵⁴

Iviewit. In that capacity, Mr. Wheeler periodically conferred with patent counsel, Iviewit representatives, and even Mr. Rubenstein in limited instances. Faced with this reality, Mr. Bernstein alleges – again without any support – that Proskauer must have tampered with or altered its billing statements. There is no truth to this assertion. We provided you with a complete set of our billing records in our April 7, 2003 submission. Should you have any questions whatsoever regarding our statements, please feel free to ask.

⁵⁴ *Supra* Note 31 at 5.



DEPOSITION OF MR. WHEELER STATING WHAT RESPONDENT NEEDS TO DETERMINE THE PATENTABILITY OF THE COMPANY S INVENTIONS

20 Q. And it says specifically, and I quote,
21 since there seems to be some confusion as to what Ken
22 needs in order to determine the patentability of your
23 process?

24 A. Right.

25 Q. I'm arranging a conference call between
1 you, me and Ken in which we can discuss it.

2 A. Right.

ELECTRONIC MAIL MESSAGE OF MR. WHEELER ARRANGING TELECONFERENCE WITH RESPONDENT TO DISCUSS HIS OVERSIGHT OF THE PATENT PROSECUTION PROCESS

-----Original Message-----

From: Christopher Wheeler [mailto:CWHEELER@proskauer.com]

Sent: Friday, May 28, 1999 6:26 AM

To: alps@netline.net

Subject: Tuesday Meeting

** High Priority **

Eliot,

Ken Rubenstein will be available on Tuesday morning sometime between 8:30 and 9 to discuss the patents. We can conference him in after we start with Joao and ourselves. Have you already made sure that Joao will be available? Please advise immediately.

Best regards,

Chris



EXHIBIT U



DEPOSITION OF MR. UTLEY STATING THAT HE NEVER DISCUSSED THE COMPANY S INVENTIONS WITH RESPONDENT

23 THE WITNESS: But, like I say, I do
24 recall that I had one conversation with Ken
25 Rubenstein, but I absolutely do not recall the

Pat Carl & Associates (763)591-0535 or (800)591-9PCA (722)

Proskauer Rose, et al. vs Iviewit.Com, Inc., et al. 8/22/02

1 content of the conversation. It was not anything 141
2 that was material to what Iviewit did.
3 By MR. SELZ:

DEPOSITION OF MR. UTLEY STATING THAT HE HAD CONVERSATION WITH RESPONDENT TO APPRISE HIM OF THE STATUS OF THE COMPANY S PATENT PROSECUTION PROCESS PRIOR TO A CONTRACT WITH WARNER BROS.

Q. Did you ever have any discussions
with Mr. Rubenstein with regard to the
intellectual properties of Iviewit?

A. I can recall that I had discussion
that briefed him on where we were in terms of
filing patents covering the Iviewit IP, but it

Pat Carl & Associates (763)591-0535 or (800)591-9PCA (722)



was a general discussion.

Q. And what was the purpose of that discussion with Mr. Rubenstein?

A. I believe that that was to inform him of where Iviewit was relative to its IP because there was a proposed contact between the Warner Brothers representative on the patent pool and Mr. Rubenstein for the purpose of suggesting that the Iviewit technology was, had some substance.

Q. Had some what?

A. Substance.

Q. Substance, okay. But it wasn't anything more in depth than just advising him that it was in the process of --

A. It was a single phone call which I made to him.

Q. And about what date was that, if you can recall?

A. Oh, it was in late 2000, fourth quarter 2000.

Q. Did you ever have any other conversations with Mr. Rubenstein, other than the one you've already described?

A. I don't recall any other

conversations, no.

MR. UTLEY REITERATES THAT RESPONDENT HAD NO ROLE

9 THE WITNESS: Well, Rubenstein and
10 Mr. Wheeler, I'll repeat, had nothing to do with
11 the patents and therefore, I object to them being
12 included in the question.

MR. UTLEY AGAIN STATES RESPONDENT HAD NO ROLE

3 Q. Well, let's go to my next question
4 on this whole thing, and that is, with regard to,
5 with regard to the approval by the board of
6 directors, we've talked prior about the board of
7 directors and Ken Rubenstein, was Ken
8 Rubenstein -- you've previously stated that he
9 didn't have any role with regard to the company,
10 no active role?

11 A. That's correct.

12 Q. And I hate to bounce back and forth
13 to you about this, he was never, like, an advisor
14 or consultant or anything like that; he was just
15 someone who was Proskauer Rose's person who did
16 work on IP?

17 A. Yeah, I can't speak to the
18 discussions that may have taken place between
19 Mr. Wheeler and Mr. Rubenstein, but --

20 Q. I'm not asking you to. I'm just
21 saying from what you know because obviously this
22 deposition testimony is given on your own
23 personal knowledge.

24 A. Yes. He played no active role in
25 the company other than having directed the



**MR. UTLEY, REVERSING COURSE, AND NAMING RESPONDENT AS
ADVISOR**

From: Brian G. Utley [brian@iviewit.com]
Sent: Wednesday, April 18, 2001 8:17 AM
To: Eliot I. Bernstein; 'simon@adelphia.net'; 'kanderson@myCFO.com'; 'dg_kane@msn.com'; 'glewin@goldsteinlewin.com'; 'hankpow@gate.net'; 'bprolow@tiedemannfunds.com'; Maurice Buchsbaum
Cc: 'Christopher C. Wheeler (E-mail)'
Subject: RE: Minutes of the Board Meeting of April 14, 2001

I was advised by Proskauer Rose that anyone who was in an active due diligence stage and who was reviewing our intellectual property as part of that due diligence should receive a copy of the examiners opinion. Therefore the opinion was forwarded to the same people who have received copies of the patent filings namely, Warner Brothers and Irell & Manella. Ken Rubenstein, as our advisor, was also copied. Your father suggested that, because of the importance of our intellectual property, our own Board of Directors should be aware of the current status of our applications. With respect to Irell & Manella, it is quite likely that we will need to engage them or some other alternative counsel in order to respond to the opinion. I have a copy of Alvear's book if you need it.

With respect to processing the requested demo tape, you may recall that you actually set the standard by processing similar demo material for igallery some time ago. This job was handled discreetly and the 18 year old employee referred to had already been released from the business. We are not in the business of processing adult entertainment material and have consistently represented this position. I trust this clarifies both matters.
Brian

**MR. UTLEY, REVERSING COURSE AGAIN, ASKING WHAT ROLE TO
PROVIDE FOR RESPONDENT**

-----Original Message-----
From: Brian G. Utley [mailto:brian@iviewit.com] On Behalf Of Brian
Sent: Thursday, January 13, 2000 9:33 AM
To: 'cwheeler@proskauer.com'; 'ccwhlaw@aol.com'
Subject: Business Plan

Your name and Ken Rubenstein's name are proposed as members of an iviewit advisory board. Does this give you a problem?
Brian



**MR. UTLEY EXPRESSLY PASSES PATENT INFORMATION FOR
RESPONDENT S REVIEW**

April 16, 2001

Kenneth Rubenstein
Proskauer Rose LLP
1585 Broadway
New York, NY 10036

Dear Ken,

Re: iviewit Video Patent Applications

Ken, for your information, we have received the attached PCT opinion relative to the iviewit patent applications.

If you have any comment or questions do not hesitate to call me.

Yours truly,

Brian Utley
President

BU/bmb

cc: Chris Wheeler



EXHIBIT V



ELECTRONIC MAIL MESSAGE OF MR. KASSER ALLEGING MR. HERSH, FORMER CHIEF FINANCIAL OFFICER OF THE COMPANY, WITH FRAUD PERTAINING TO REVENUE ACCOUNTS OF THE COMPANY

Eliot,

Here is the information I promised you this afternoon. Attached are the Goldstein Lewin compiled financial statements as of December 31, 2000, the detail of the income accounts and the Doyle invoice. The income account detail (three accounts) totals \$248,070.75, consistent with the \$248,071 revenue number in the financial statements. As you can see, without the Doyle number the Gross Profit for the year would have been well under \$100,000.

They fattened the number and palmed it off on Lewin. These financial statements were submitted to Crossbow. They may have also been given to Wachovia and others. I do not have the purchase order. Please see if it is with the papers recovered from Larry.

I tried last spring to locate Doyle Occupational. The phone number in our records is not valid. There is a Doyle Occupational Health Clinic in Nashville, but it is not related to this group. There is a Jason Speaks listed in the Nashville phone directory, but last spring he did not return my call.

Bill

iviewit.com, Inc.
2255 Glades Road, Suite 337W
Boca Raton, FL 33431

Doyle Occupational Health & Training
Jason Speaks
2000 Glen Echo Road, Suite 120
Nashville, TN 37215

DATE: 12/29/2000
INVOICE NO: 136
DUE DATE: 1/28/2001

SERVICES PROVIDED	AMOUNT
Database Creation & Management Fee	5,000.00
Development of Courses for the National Guard	95,000.00

TOTAL \$100,000.00



APPENDIX I



[INSERT WITNESS LIST]